



DEUTSCH
INDUSTRIAL



DT Series Technical Manual



Table of Contents

Introduction	2, 3	Contact Retention System	10
Features & Benefits	3	Assembly Contact Insertion / Removal	11
Product Line Overview	4	Accessories	12
Material Specifications	5	Shrink Boot Adaptor	12
General Specifications	5	Removal Tools / Sealing Plugs	12
Ordering Information	6	DT Mounting Clips	13
Insert Arrangements	7, 8	Back Shells	14, 15
Contacts & Application Data	9		

Environmentally-Sealed Transportation Connectors



Deutsch DTM Series

Deutsch DTM Series of transportation connectors feature a miniature contact with an enhanced design based on the world class, field-proven Deutsch DT Series.

The DTM is the connector to be used in harsh environmental application where reliable signal circuits are critical to operating performance. Typical applications include on or around the engine, the transmission and under the hood.

Deutsch DT Series

An environmentally-sealed connector designed specifically for cable to cable applications on the engine or transmission, under the hood, on the chassis or in the cab. On signal level circuits in harsh environmental conditions, where even a small degradation in connection may be critical, the Deutsch DT Series general purpose connectors will provide the reliability and performance at the lowest cost.





Deutsch DTP Series

Deutsch's DTP Series connectors are the answer to all of your most demanding power application requirements. DTP Series connectors offer the proven reliability and quality of Deutsch's DT Series, combined with the added flexibility of using power contacts.



Deutsch DTHD Series

Deutsch developed the DTHD Series for those applications requiring a complete, environmentally sealed, single power circuit termination. The plug features an integral coupling latch that provides tactile and audible feedback during coupling. The rugged thermoplastic receptacle is designed as an inline for cable to cable applications and is supplied with an integral Vee-Groove to accept mounting, clips, brackets and flanges.



Deutsch DT Bussed Series

Utilizing the Deutsch DT receptacle shell, Deutsch has combined the rugged characteristics of the DT product line with a bussing device allowing the elimination of various harness splices. By using internal stamped bussed contacts this product can be configured in whatever arrangement meets your individual needs in the DT shell size that matches your requirements. Complete bussing flexibility in a compact, economical package.

Features	Benefits
Integral Connector Latch	Tactile and Audible Assembly Feedback
Rugged Thermoplastic Housing	Field Proven Long Service Life
-55° C to +125° C Operating Temperature	Engine Compartment Rated
Available Configurations:	
DTM/DT 2, 3, 4, 6, 8 & 12 - Size 20/16	Meets Most Harness Design Requirements
DTP 2 & 4 - Size 12	
DTHD 1 - Size 4, 8 & 12	
Silicone Seals:	
DTM: Accepts AWG 22 - 16 wire	Seals on .053" to .120 dia.(1.35mm to 3.05mm)
DT: Accepts AWG 20 - 14 wire	Seals on .053" to .145 dia.(1.35mm to 3.68 mm)
DTP: Accepts AWG 14 - 10 wire	Seals on .097" to .170 dia.(2.46mm to 4.32mm)
DTHD: Accepts AWG 14 - 6 wire	Seals on .134 to .292 dia.(3.40mm to 7.42mm)
Crimp Contacts with Option of Gold or Nickel Finish, Solid or Stamped Construction	Low Costs, High Reliability Terminals for Data & Signal Transmission
Current rating all contacts @ 125° C no derating	
DTM - 7.5 Amps	
DT - 13 Amps	Meets Most Signal Requirements
DTP - 25 Amps	
DTHD - 25 to 100 Amps	
Fail-Safe Secondary Locks All (Except DTHD)	Positive Contact Retention
Hand Insertable/Removable Contacts	No Special Tools Required (Except DTHD)
Budget Minded	Low Installation Costs





Product Line Overview

Deutsch DTM Series

Deutsch DTM Series of transportation connectors feature a miniature contact with an enhanced design based on the world class, field-proven Deutsch “DT Series”.

The DTM is the connector to be used in harsh environmental applications where reliable signal circuits are critical to operating performance. Typical applications include on or around the engine, the transmission and under the hood. In fact, everywhere data signals or critical electronic circuits go, the field proven Deutsch design of the DTM will provide reliable peak connector performance.

The low cost, size 20 contacts terminate AWG 16 to 22 gauge wire (0.5mm² to 1.5mm²). Closed entry socket (female) contacts featuring spring action fingers are protected by a stainless steel hood. This allows for positive axial alignment while mating and prevents probe damage during testing.

Thermoplastic housings offer a wide operating temperature range (-55° C to +125° C). Silicone rear wire and internal peripheral interface seals allow the DTM to withstand moisture and fluids.

Deutsch DT Series

Deutsch DT Series of environmentally-sealed, connectors are designed specifically for cable to cable applications on the engine or transmission, under the hood, on the chassis or in the cab. Where signal level circuits in harsh environmental conditions, where even a small degradation in connection may be critical, the Deutsch DT Series general purpose connectors will provide the reliability and performance at the lowest cost.

Thermoplastic (-55° C to + 125° C rated) housings and silicone seals are used to allow the connector to withstand conditions of extreme temperature and moisture. The connector may be employed with either solid-copper crimp type contacts for critical circuits or budget-minded stamped and formed contacts. In either selection, the spring action is designed in the socket and shrouded by a stainless steel hood that provides closed entry for positive axial alignment during mating, and eliminates probe damage from occurring. Contact insertion and withdrawal require no special tools and are retained in locked position by dielectric fingers, molded as an integral part of the housing. Secondary locks are assembled at the mating interfaces. If by chance the secondary locks are not properly seated during assembly, they will be pressed into locked position during the mating of the connector.

Deutsch DTP Series

Building on both the DT and DTM design strengths, the DTP connector line was developed to fill the need for higher amperage, multi-pin, inexpensive connectors. The series meets the same specifications as the DTM and DT but offers the designer the ability to use multiple 12 gauge contacts, each with a 25 amp continuous capacity, within a single shell.

Based on the DTM overall design, it offers the protected interfacial seal located within the receptacle shell. Standard multi-seal grommet is used in both the plug and receptacle. Currently available in two and four pin configurations.

Deutsch DT Bussed Series

These standard “DT” receptacle shells feature internal pin type contact buss bar arrangements that allow common connections from 3 to 12 size 16 contacts. Buss bars are available in standard nickel or gold to match common Deutsch Industrial contacts.

Other features include the use of standard “DT” plugs to mate with these environmental receptacles. Plugs with any Deutsch modification are intermatable.

Deutsch DTHD Series

Deutsch developed the DTHD Series for those applications requiring a complete, environmentally sealed, single power circuit termination. DTHD plugs and receptacles can be permanently assembled with thermoplastic end caps that prevent removal of the silicone wire seal grommets. Designed for diesel engine, electronic fuel injectors, automatic transmissions, ABS brakes and other applications that involve fuel and oil exposure. These end caps provide the additional reliability required for critical wiring circuits.





MATERIAL SPECIFICATIONS

Plug/Receptacle

Shell: Thermoplastic
 Wedge: Thermoplastic
 Grommet: Silicone Rubber

Contacts

Pin: Copper Alloy
 Socket: Copper Alloy
 Finish: Nickel (optional - gold) Plated

Sealing Plugs

Thermoplastic: (All sizes)

Thermal Cycle:

No cracking, chipping or leaking after 20 test cycles from -55°C to +125°C.

Durability:

No electrical or mechanical defects after 100 cycles of engagement and disengagement.

GENERAL SPECIFICATIONS

Dielectric Withstanding Voltage

Current leakage less than 2 milliamps at 1500 VAC

Insulation Resistance:

1000 megohms minimum at 25° C.

Current Rating (Contact current rating @ 125° C (continuous))

- Size 20: 7.5 amps
- Size 16: 13 amps
- Size 12: 25 amps
- Size 8: 60 amps
- Size 4: 100 amps

Submersion:

Properly wired and mated connection will withstand immersion under three feet of water without loss of electronic qualities or leakage.

Fluid Resistance:

Connectors show no damage when exposed to most fluids used in industrial applications.

Vibration:

No unlocking or unmating and exhibits no mechanical or physical damage after sinusoidal vibration levels of 20 G's at 10 to 2000 Hz in each of the three mutually perpendicular planes. No electrical discontinuities longer than 1 microsecond.

Temperature:

Operative at temperatures from -55°C to +125°C. Continuous at rated current.

Contact Retention:

Contacts withstand a minimum load of:

- 20 lbs (89N) for size 20
- 25 lbs (111N) for size 16
- 30 lbs (133N) for size 12
- 35 lbs (156N) for size 8
- 35 lbs (156N) for size 4

CONTACT RESISTANCE

CONTACT SIZE	WIRE GAUGE AWG(mm²)	Test Current (Amps)	Resistance (mV) Solids	Resistance (mV) Stamped & Formed
20	22 (.35)	5.0	N/A	100
20	20 (.50)	7.5	60	100
	18 (.80)	7.5	60	100
	16 (1.0)	7.5	60	100
16	20 (.50)	7.5	60	100
	18 (.80)	10	60	100
	16 (1.0)	13	60	100
12	14 (2.0)	13	60	100
	12 (3.0)	18	60	100
	12 (3.0)	25	60	100
8	8 (8.60)	60	60	N/A
	10 (5.60)	60	60	N/A
4	6 (13.0)	100	60	N/A

WIRE SEALING RANGE

CONTACT SIZE	RECOMMENDED WIRE INSULATION O.D.	
	N-SEAL	E-SEAL
#20	.053-.120 (1.35-3.05)	N/A
#16	.088-.145 (2.24-3.68)	.053-.120 (1.35-3.05)
#12	.134-.170 (3.40-4.32)	.097-.158 (2.46-4.01)
#8	.190-.240 (4.83-6.10)	N/A
#4	.280-.292 (7.11-7.42)	N/A





PART NUMBERING SYSTEM (DTM)

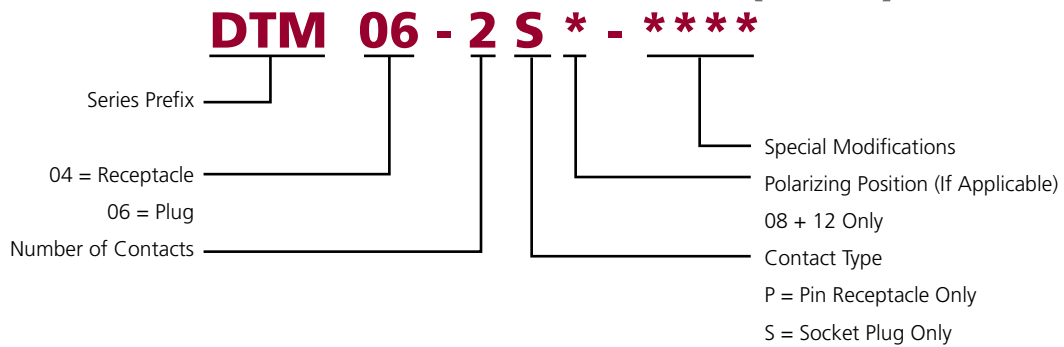

PART NUMBERING SYSTEM (DT & DT Bussed)

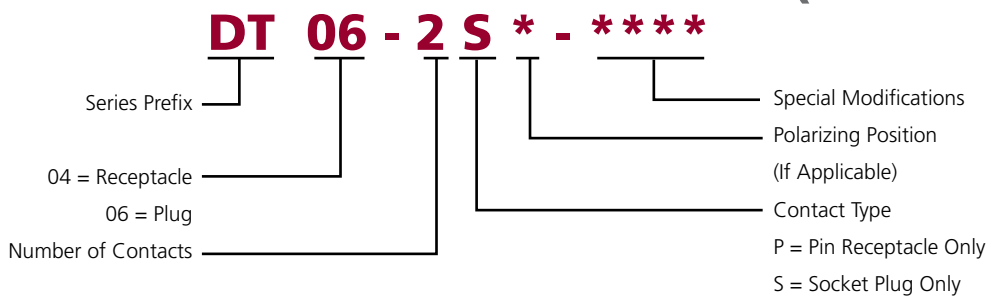

PART NUMBERING SYSTEM (DTP)

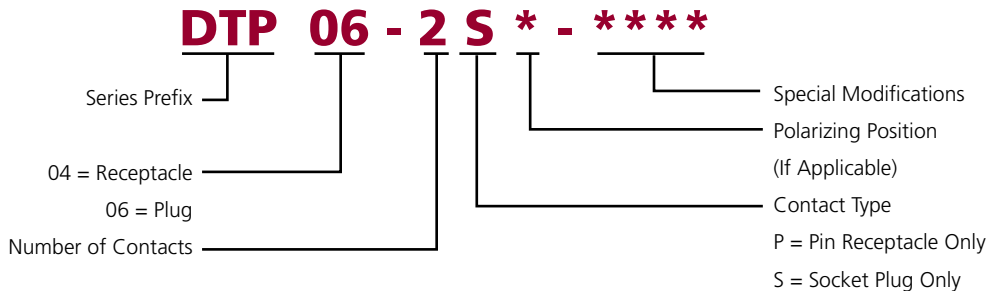

PART NUMBERING SYSTEM (DTHD)

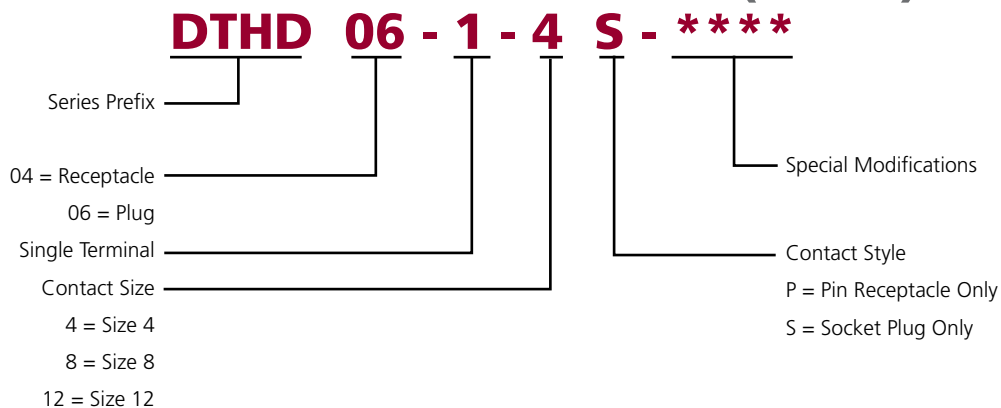



DTM Series Size 20 Contacts

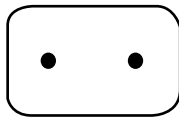

2
2 size 20

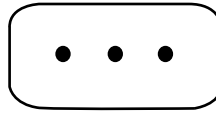

3
3 size 20

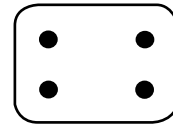

4
4 size 20

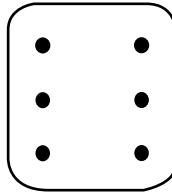

6
6 size 20

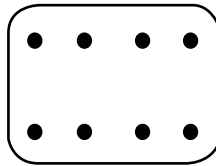

8
8 size 20

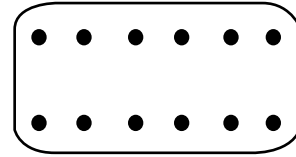

12
12 size 20

DT & DT BUSSED Series Size 16 Contacts

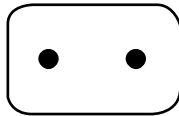

2
2 size 16

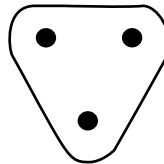

3
3 size 16

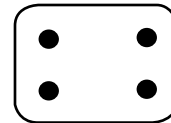

4
4 size 16

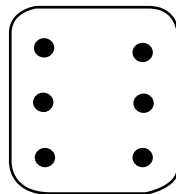

6
6 size 16

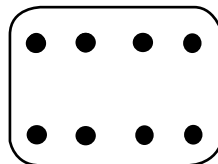

8
8 size 16

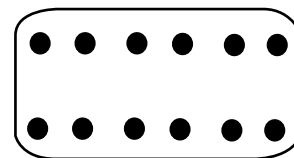

12
12 size 16

DTP Series Size 12 Contacts

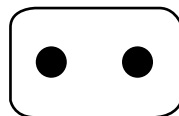

2
2 size 12

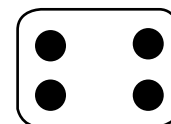

4
4 size 12

DTHD Series Size 4, 8 & 12

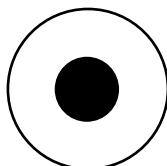

1
1 size 4

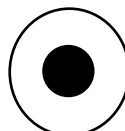

1
1 size 8

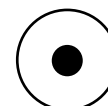

1
1 size 12



DT Series BUSSED Arrangements

Standard DT Receptacles Bussed to Customer Specifications

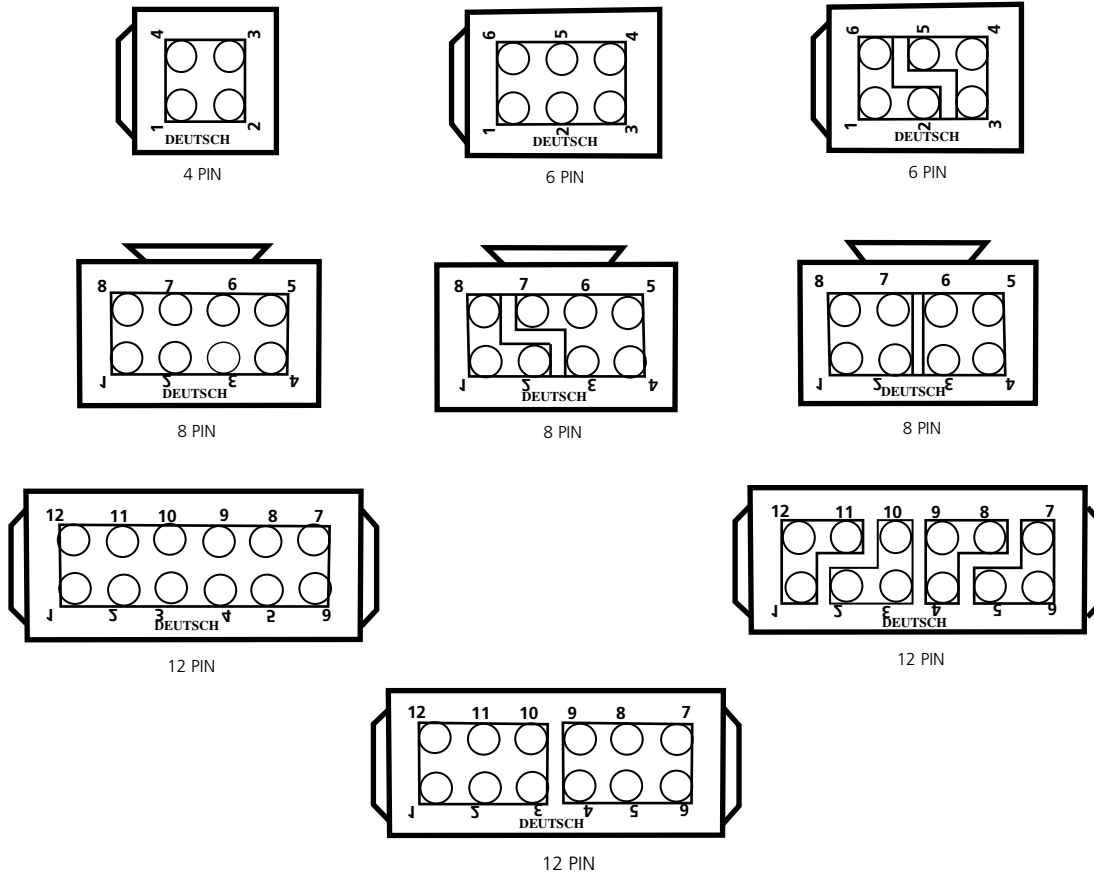

Arrangements shown are currently available. For additional arrangements contact factory.

ALL PART NUMBERS ARE FOR "BLACK"

MAX CURRENT RATINGS	NICKEL BUSS P/N	GOLD BUSS P/N	MATING PLUG P/N
4 PIN = 26 AMPS	DT04-4P-EP13	DT04-4P-EP12	DT06-4S-****
6 PIN = 39 AMPS	DT04-6P-EP13	DT04-6P-EP12	DT06-6S-****
3 PIN = 13 AMPS	DT04-6P-EP14	DT04-6P-EP15	DT06-6S-****
8 PIN = 52 AMPS	DT-8PB-P021	DT04-8PB-P016	DT06-08SB-****
5 PIN = 26 AMPS	DT04-8PB-P028	DT04-8PB-P029	DT06-08SB-****
4 PIN = 26 AMPS	DT04-8PB-P026	DT04-8PB-P027	DT06-08SB-****
3 PIN = 13 AMPS	DT04-3P-***	DT04-3P-***	DT06-3S-****
12 PIN = 76 AMPS	DT04-12PB-P021	DT04-12PB-P016	DT06-12SB-****
6 PIN = 39 AMPS	DT04-12PB-P026	DT04-12PB-P027	DT06-12SB-****
3 PIN = 13 AMPS	DT04-12PB-P030	DT04-12PB-P031	DT06-12SB-****

PLEASE CONSULT FACTORY FOR AVAILABILITY AND ALTERNATE KEYING



CONTACTS AND APPLICATION DATA

Solid Contacts

SIZE	SOLID CONTACT PART NUMBERS		WIRE SIZE AWG (mm ²)	RECOMMENDED STRIP LENGTH INCHES (mm)	MIN CONTACT RETENTION LBS (N)	REF CRIMP TENSILE LBS (N)	MAX RATED AMPS AT 125°C CONTINUOUS
	PIN	SOCKET					
20	0460-010-20**	0462-005-20**	16-18 (1.0-0.75)	.156-.218 (3.96-5.54)	20 (89)	20 (89)	5.0
20	0460-202-20**	0462-201-20**	20 (0.50)	.156-.218 (3.96 - 5.54)	20 (89)	20 (89)	7.5
16	0460-202-16**	0462-201-16**	16-20 (1.0 - 0.50)	.250 - .312 (6.35 - 7.92)	25 (111)	35-20 (156-89)	13
16	0460-215-16**	0462-209-16**	14 (2.0)	.250 - .312 (6.35 - 7.92)	25 (111)	70 (311)	13
12	0460-204-12**	0462-203-12**	12-14 (3.0 - 2.0)	.222 - .284 (5.64 - 7.21)	30 (134)	75-70 (334 - 311)	25
8	0460-204-08**	0462-203-08**	8-10 (8.0 - 5.0)	.430 - .492 (10.92 - 12.50)	35 (156)	125-90 (556-400)	60
4	0460-204-04**	0462-203-04**	6 (13.0)	.430-.492 (10.92-12.50)	35 (156)	300 (1334)	100

* See Envelope Print 0425-205-0000. Consult factory for alternate finishes.

Solid Contacts

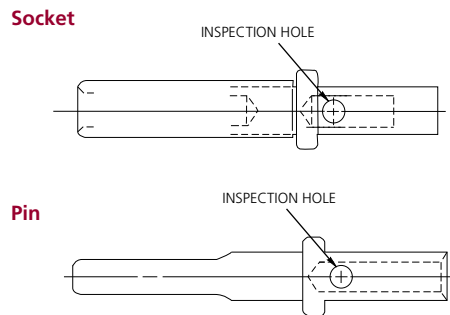

Stamped and Formed Contacts

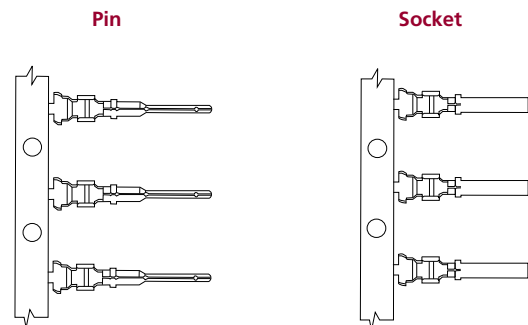

Stamped & Formed Contacts

SIZE	STAMPED & FORMED CONTACT PART NUMBERS		CARRIER STRIP IDENTIFICATION	WIRE SIZE AWG (mm ²)	WIRE INSULATION O.D. RANGE	RECOMMENDED STRIP LENGTH INCHES (mm)	MIN CONT. RETENTION LBS (N)	REF CRIMP TENSILE LBS (N)	MAX RATED AMPS AT 125°C CONTINUOUS
	PIN	SOCKET							
20	1060-20-01**	1062-20-01**	20 - 01	16 - 22 (1.5 - 0.35)	.075 - .125 (1.91 - 3.15)	.150 - .200 (3.81 - 5.08)	20 (89)	20 - 10 (89 - 45)	7.5
20	1060-20-02**	1062-20-02**	20 - 02	16 - 22 (1.5 - 0.35)	.051 - .085 (1.30 - 2.16)	.150 - .200 (3.81 - 5.08)	20 (89)	20 - 10 (89 - 45)	7.5
20	N/A	1062-20-03**	20 - 03	16 - 22 (1.5 - 0.35)	.075 - .125 (1.91 - 3.15)	.150 - .200 (3.81 - 5.08)	20 (89)	20 - 10 (89 - 45)	7.5
20	1060-20-06**	1062-20-06**	20 - 06	14 - 16 (2.5 - 1.0)	.075 - .125 (1.91 - 3.15)	.150 - .200 (3.81 - 5.08)	20 (89)	20 - 10 (89 - 45)	7.5
16	1060-14-01**	1062-14-01**	14-16	14 - 18 (2.0 - .75)	.095 - .150 (2.41 - 3.81)	.150 - .200 (3.81 - 5.08)	25 (111)	25 (111)	13
16	1060-14-10**	1062-14-10**	14 - 16	14 - 18 (2.0 - .75)	.095 - .150 (2.41 - 3.81)	.150 - .200 (3.81 - 5.08)	25 (111)	25 (111)	13
16	1060-16-01**	1062-16-01**	16 - 18	14 - 18 (2.0 - .75)	.075 - .140 (1.91 - 3.55)	.150 - .200 (3.81 - 5.08)	25 (111)	25 (111)	13
16	1060-16-06**	1062-16-06**	0.5 - 1.0	16 - 20 (1.0 - 0.50)	.055 - .100 (1.40 - 2.54)	.150 - .200 (3.81 - 5.08)	25 (111)	25 - 15 (111 - 67)	13
16	1060-16-07**	1062-16-07**	0.75 - 2.0	14 - 18 (2.0 - .75)	.075 - .140 (1.91 - 3.55)	.150 - .200 (3.81 - 5.08)	25 (111)	25 (111)	13
16	1060-16-09**	1062-16-09**	16 - 18	14 - 18 (2.0 - .75)	.075 - .140 (1.91 - 3.55)	.150 - .200 (3.81 - 5.08)	25 (111)	25 (111)	13
16	1060-16-12**	1062-16-12**	1.0 - 2.5	12 - 16 (2.5 - 1.0)	.075 - .140 (1.91 - 3.55)	.175 - .225 (4.45 - 5.72)	25 (111)	25 (111)	13
16	N/A	1062-16-14**	14 - 16	12 - 16 (2.5 - 1.0)	.075 - .140 (1.91 - 3.55)	.175 - .225 (4.45 - 5.72)	25 (111)	25 (111)	13
12	1060-12-01**	1062-12-01**	12 - 14	12 - 14 (4.0 - 2.0)	.113 - .176 (2.87 - 4.47)	.225 - .275 (5.72 - 6.991)	30 (134)	70 (311)	25
12	1060-12-02**	1062-12-02**	10 - 12	10 - 12 (6.0 - 4.0)	.140 - .204 (3.56 - 5.18)	.225 - .275 (5.72 - 6.99)	30 (134)	70 (311)	25

** = Plating Codes Consult factory for custom finish needs. Consult factory for alternate finishes
 For 12 Size, see 0425-041-0000 and 0425-208-0000
 For 16 Size, see 0425-039-0000, 0425-059-0000, and 0425-203-0000
 For 20 Size, see 0425-059-0000 and 0425-207-0000



Contact Retention System (DTHD)

Required Removal Tool (See page 12)

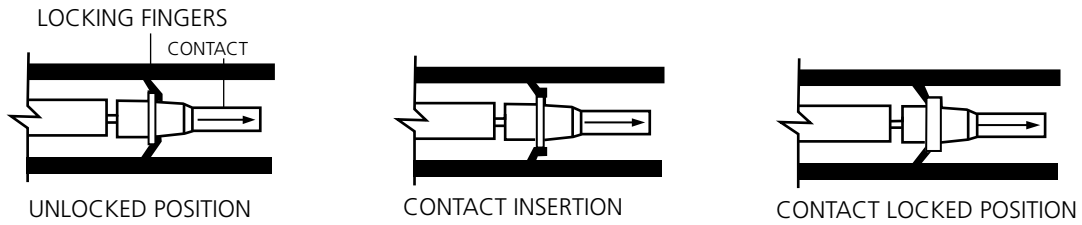

Contact Removal Procedure

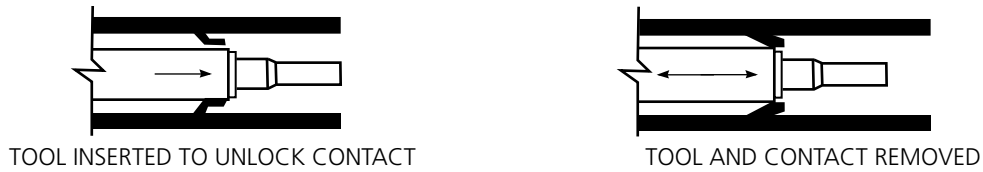

Contact Insertion System (DTM/DT/DTP)

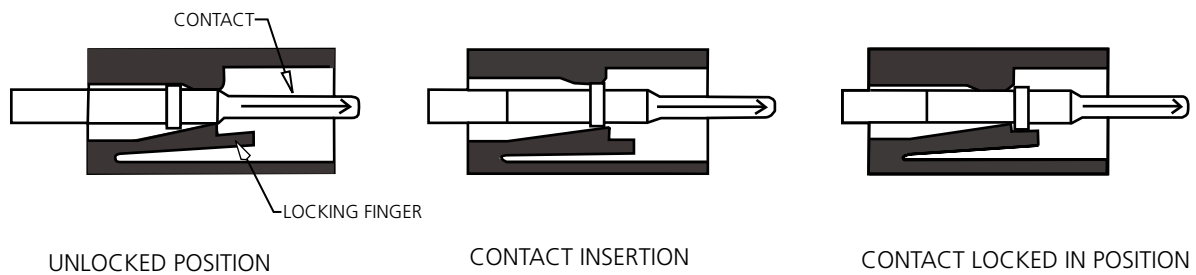

Contact Removal Procedure (DTM/DT/DTP)

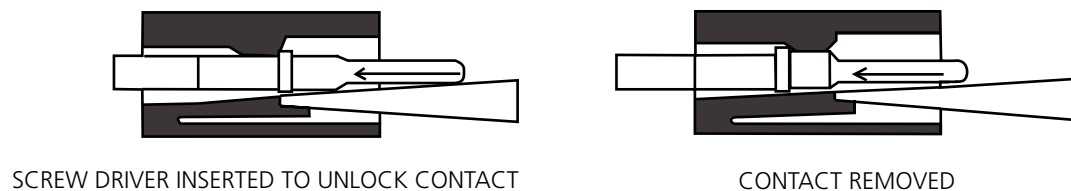



Assembly Contact Insertion (DTM, DT, DTP)

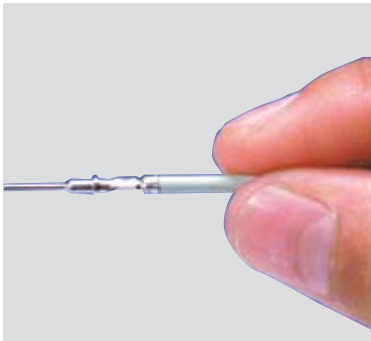

1. Grasp crimped contact approximately 1.0" (25.4mm) behind the contact barrel.

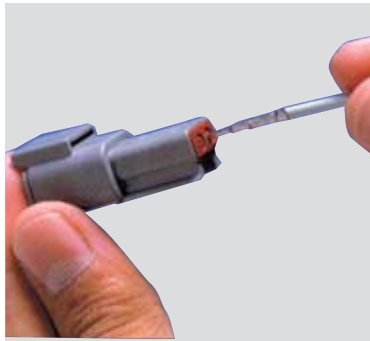

2. Hold connector with rear grommet facing you.

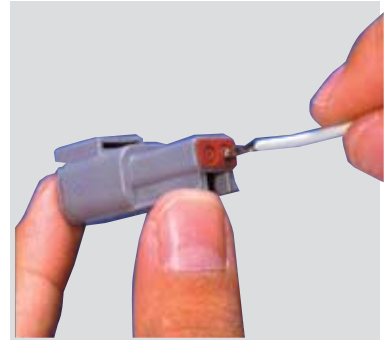

3. Push contact straight into connector grommet until a click is felt. A slight tug will confirm that it is properly locked in place.

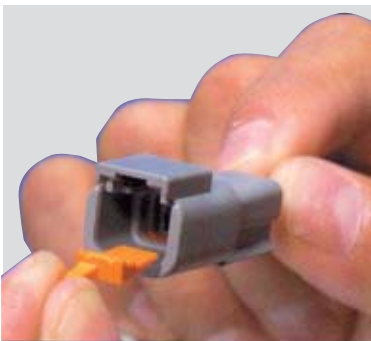

4. Once all contacts are in place, insert orange wedge: receptacles - with half holes aligning with contacts. Plugs - with contacts aligning behind full holes. The orange wedge will snap into place.

NOTE: The receptacle is shown - use the same procedure for plug.

Contact Removal

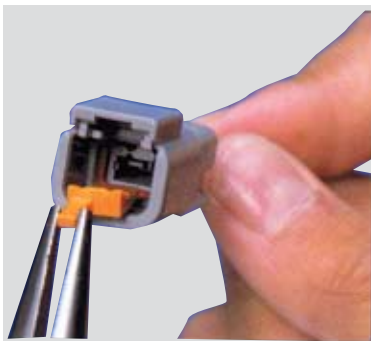

1. Remove orange wedge using needle-nose pliers to pull wedge straight out.

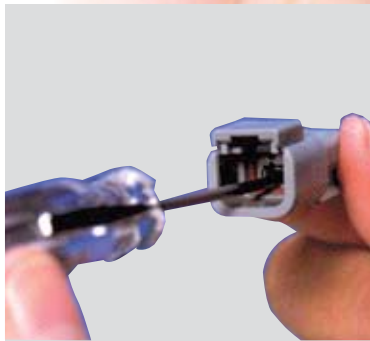

2. To remove the contacts, gently pull wire backwards, while at the same time releasing the locking finger by moving it away from the contact with a screwdriver.



3. Hold the rear seal in place, as removing the contact will displace the seal.



Accessories



To meet the application requirements where wires are to be protected, the DT Series may be supplied with boot adaptors. These will accept shaped boots / sleeves or shrink tubing. Parts for standard or thin wall wire are available.

Shrink Boot Adaptor Modification Numbers

Part Number - Plugs

Part Number - Receptacles

Number of Ways	Basic Part Number	Grey		Black		Number of Ways	Basic Part Number	Grey		Black	
		Std.	Thin Wall	Std.	Thin Wall			Std.	Thin Wall	Std.	Thin Wall
2	DT06-2S	-E008	-CE04	-EP11	-CE13	2	DT04-2P	-E008	-CE04	-EE01	-CE09
3	DT06-3S	-E008	-CE04	-EP11	-CE13	3	DT04-3P	-E008	-CE04	-EE01	-CE09
4	DT06-4S	-E008	-CE04	-EP11	-CE13	4	DT04-4P	-E008	-CE04	-EE01	-CE09
6	DT06-6S	-E008	-CE04	-EP11	-CE13	6	DT04-6P	-E008	-CE04	-EE01	-CE09
8	DT06-8SA	-E008	-CE04	-EP11	-CE13	8	DT04-8PA	-E008	-CE04	-EE01	-CE09
12	DT06-12SA	-E008	-CE04	-EP11	-CE13	12	DT04-12PA	-E008	-CE04	-EE01	-CE09

DTHD Removal Tools

Sealing Plugs

NORMAL WIRE SEALS (N)			EXTRA THIN WALL WIRE SEALS (E)			SEALING PLUG	
PART NO.	SIZE	WIRE RANGE AWG	PART NO.	SIZE	WIRE RANGE AWG	CONTACT SIZE	PART NO.
114010	12	12-14	0411-337-1205	12	12-14	20	0413-204-2005
114008	8	8-10	0411-353-0805	8	8-10	16-12	114017
114009	4	6	114009	4	6	8	114018
						4	114019

Wire Sealing Range: Standard - 2.24mm - 3.68mm (0.088188" - 0.144881) wire insulation diameter
Thin wall - 1.35mm - 3.05mm (0.053149 - 0.120098") wire insulation diameter

DT Mounting Clips

Metal Mounting Clips



1027-001-0800



1027-003-1200



1027-004-1200



1027-005-1200



1027-014-0800



1011-026-0205
(Thru Hole)

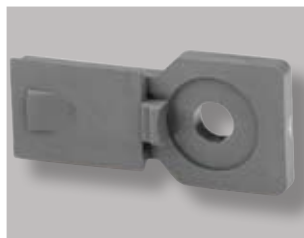

1011-027-0805
(Thru Hole)



1011-030-0205
(Snap Fit)

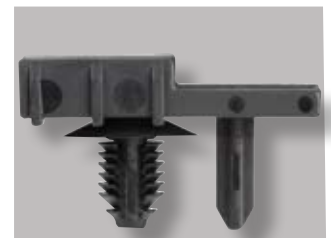

1011-310-0205
(W/Self Mounting Stud)

Metal Mounting Clips

Plastic Mounting Clips

Part Number	Used On	Material	Hole O.D. in. (mm)	Part Number	Used On	Material	Color
1027-003-1200	DTM (all) DT 2, 3, 4, 6, 12 DTP (all) DTHD (all)	Stainless Steel	.433 (11.0)	1011-026-0205	DTM (all) DT 2, 3, 4, 6, 12 DTP (all) DTHD (all)	Plastic	Gray
1027-005-1200	DTM (all) DT 2, 3, 4, 6, 12 DTP (all) DTHD (all)	Stainless Steel	.512 (13.0)	1011-027-0805	DT 8 Cavity Only	Plastic	Gray
1027-004-1200	DTM (all) DT 2, 3, 4, 6, 12 DTP (all) DTHD (all)	Steel w/Zinc Plating	.512 (13.0)	1011-030-0205	DTM (all) DT 2, 3, 4, 6, 12 DTP (all) DTHD (all)	Plastic	Black
1027-001-0800	DT 8 cavity only	Stainless Steel	.433 (11.0)	1011-031-0805	DT 8 Pin	Plastic	Black
1027-014-0800	DT 8 cavity only	Steel w/Zinc Plating	.323 (8.2)				
1027-002-0800	DT 8 cavity only	Steel w/Zinc	.512 (13.0)				
1027-006-0800	DT 8 cavity only	Steel w/Zinc	.512 (13.0)				



Back Shells

The Deutsch range of Back Shells is designed to snap fix onto the full range of standard DT connectors (i.e. without end cap). The innovative design allows each unit to accommodate several different sizes of slit or unslit corrugated tubes.

They are available for both plugs and receptacles and the options include straight (180°) and right angled (90°) adaptors for 2, 3, 4, 6, 8 and 12 way, additionally a version equipped with strain relief features 2, 3, 4 and 6 way for jacketed cables.

Material: PA 6.6 / black
IP rating: IP40

Operating Temperatures: -40 to 125° C
Handling Temperature: -5 to 45° C

Connector	Outlet	Strain Relief	Envelope Dimensions (mm)				Item No.	Part No.
			a	b	L	H		
DT04-2P	180	x	18,0	17,0	54,5	-	61031-23	1011-257-0205
	180		18,0	17,0	54,5	-	61031-33	1011-229-0205
	90	x	18,0	17,0	40,0	37,0	61031-24	1011-258-0205
	90		18,0	17,0	40,0	37,0	61031-34	1011-230-0205
DT06-2S	180	x	16,0	17,0	45,5	-	61031-25	1011-255-0205
	180		16,0	17,0	45,5	-	61031-35	1011-227-0205
	90	x	16,0	17,0	31,0	37,0	61031-26	1011-256-0205
	90		16,0	17,0	31,0	37,0	61031-36	1011-228-0205
DT04-3P	180	x	25,0	23,0	64,5	-	61051-23	1011-261-0305
	180		25,0	23,0	64,5	-	61051-33	1011-233-0305
	90	x	25,0	23,0	44,0	48,0	61051-24	1011-262-0305
	90		25,0	23,0	44,0	48,0	61051-34	1011-234-0305
DT06-3S	180	x	21,0	23,0	56,0	-	61051-25	1011-259-0305
	180		21,0	23,0	56,0	-	61051-35	1011-231-0305
	90	x	21,0	23,0	36,0	48,0	61051-26	1011-260-0305
	90		21,0	23,0	36,0	48,0	61051-36	1011-232-0305
DT04-4P	180	x	22,0	22,0	59,5	-	61048-23	1011-265-0405
	180		22,0	22,0	59,5	-	61048-33	1011-237-0405
	90	x	22,0	22,0	43,0	45,0	61048-24	1011-266-0405
	90		22,0	22,0	43,0	45,0	61048-34	1011-238-0405
DT06-4S	180	x	20,0	22,0	53,0	-	61048-25	1011-263-0405
	180		20,0	22,0	53,0	-	61048-35	1011-235-0405
	90	x	20,0	22,0	35,0	45,0	61048-26	1011-264-0405
	90		20,0	22,0	35,0	45,0	61048-36	1011-236-0405
DT04-6P	180	x	26,0	21,5	64,0	-	61057-23	1011-269-0605
	180		26,0	21,5	64,0	-	61057-33	1011-241-0605
	90	x	26,0	21,5	43,0	50,0	61057-24	1011-270-0605
	90		26,0	21,5	43,0	50,0	61057-34	1011-242-0605
DT06-6S	180	x	23,5	20,0	55,5	-	61057-25	1011-267-0605
	180		23,5	20,0	55,5	-	61057-35	1011-239-0605
	90	x	23,5	21,0	38,0	50,0	61057-26	1011-268-0605
	90		23,5	21,0	38,0	50,0	61057-36	1011-240-0605
DT-04-8P	180		27,5	28,0	62,0	-	61049-33	1011-245-0805
	90		27,5	28,0	47,5	50,5	61049-34	1011-246-0805
DT06-8S	180		26,5	28,5	57,0	-	61049-35	1011-243-0805
	90		24,5	28,5	39,5	49,0	61049-36	1011-244-0805
DT04-12P	180		26,0	35,5	63,5	-	61052-33	1011-249-1205
	90		26,0	36,5	53,0	50,5	61052-34	1011-250-1205
DT06-12S	180		23,0	36,0	58,5	-	61052-35	1011-247-1205
	90		23,0	36,0	43,5	50,5	61052-36	1011-248-1205

Tube Size by Connector and Additional Length (mm) needed

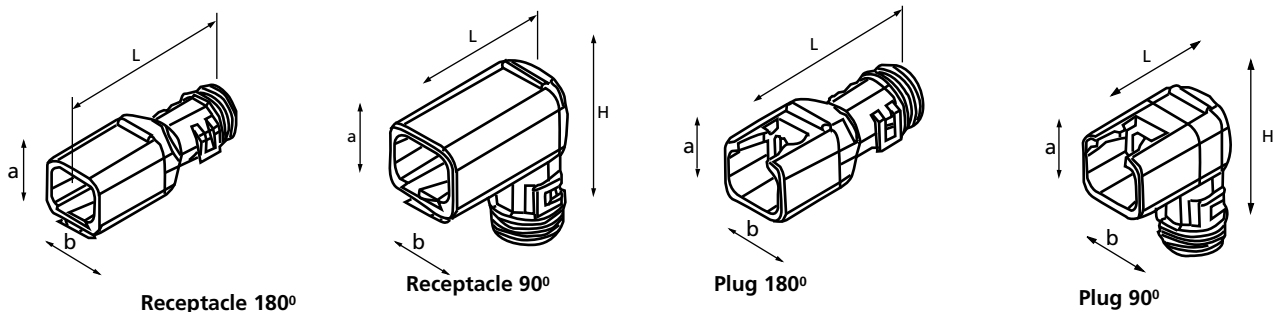



Back Shells

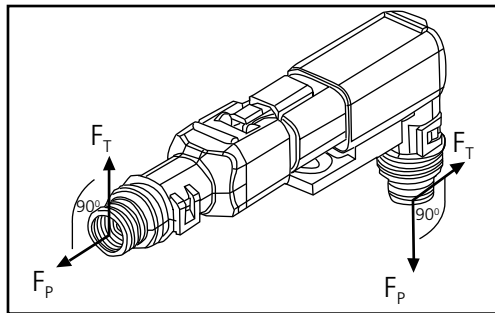
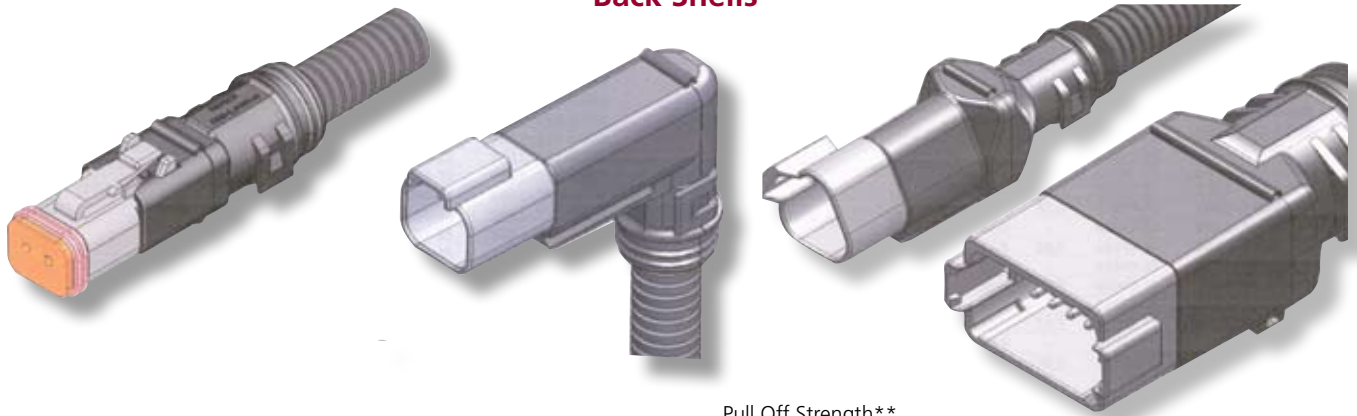

Pull Off Strength**

Connector	F _p (N)	F _t (N)
DT04-2P / DT06-2S	50 / 50	50 / 10
DT04-3P / DT06-3S	50 / 50	50 / 50
DT04-4P / DT06-4S	50 / 50	50 / 25
DT04-6P / DT06-6S	50 / 50	50 / 30
DT04-8P / DT06-8S	50 / 50	50 / 35
DT04-12P / DT06-12S	50 / 50	50 / 40

** Valid for unslit corrugated tubes. Follow also connector mounting instruction: no force must apply to wires and connector to maintain continuous tightness of the connection.

Tube size by connector and additional length (mm) needed

Connector	NW6	NW7,5	NW8,5	NW10	NW13	NW17
DT04-2P / DT06-2S	X + 16,0	X + 16,0	X + 10,0	X + 7,0	-	-
DT04-3P / DT06-3S	X + 18,0	X + 18,0	X + 12,5	X + 7,0	-	-
DT04-4P / DT06-4S	X + 16,0	X + 16,0	X + 10,0	X + 13,0	-	-
DT04-6P / DT06-6S	-	-	X + 20,0	X + 14,0	X + 7,0	-
DT04-8P / DT06-8S	-	-	X + 20,0	X + 24,5	X + 8,0	-
DT04-12P / DT06-12S	-	-	-	-	X + 16,0	X + 10,0
Corrugated	D	9,3	10,0	11,7	13,0	15,8
Tube Details	P	2,8	2,7	2,4	2,7	3,3

X = Tube length needed for harness

Ribs to be used for tube mounting*

Connector	NW6	NW7,5	NW8,5	NW10	NW13	NW17
DT04-2P / DT06-2S	6	6	4	3	-	-
DT04-3P / DT06-3S	7	7	5	3	-	-
DT04-4P / DT06-4S	6	6	4	3	-	-
DT04-6P / DT06-6S	-	-	7	5	3	-
DT04-8P / DT06-8S	-	-	7	5	3	-
DT04-12P / DT06-12S	-	-	-	7	5	3

* The corrugated tube must be placed into the ribs as per the above table.

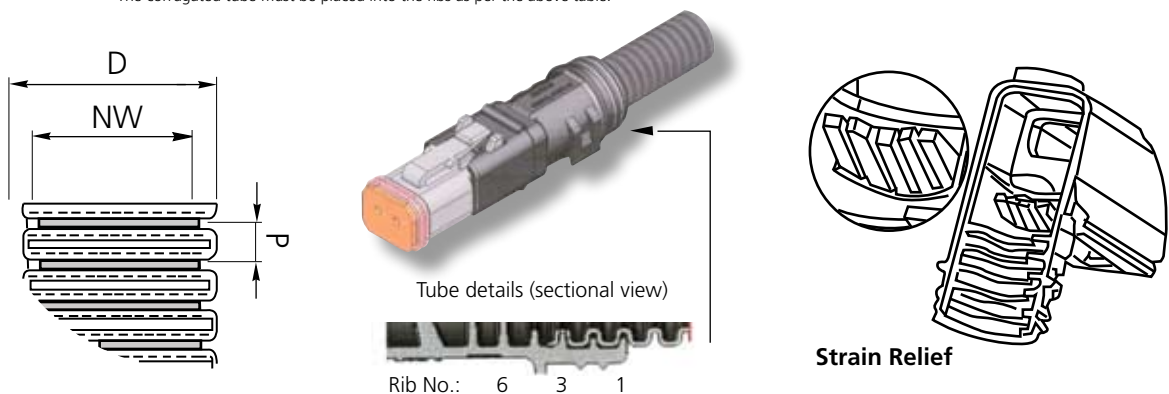

Strain Relief

Deutsch Industrial UK
Stanier Road
St. Leonards On Sea
East Sussex TN 38 9RF
England
Ph. 44 (0) 1424 852 722
Fax 44 (0) 1424 855 979
industrialuk@deutsch.net

Deutsch Industrial Europe
Fraunhoferstrasse 11b
82152 Martinsried
Germany
Ph. +49 (0) 89 899157-0
Fax +49 (0) 89 857 4684
info.eu@deutsch.net

Deutsch Connectors Trading
(Shanghai) Co., Ltd.
Room 1032, 10F Central Plaza,
381 Huai Hai Zhong Road,
Shanghai 200020, China
Tel/Fax: 86-21-6391 5902
E-mail: salesdichina@deutsch.net

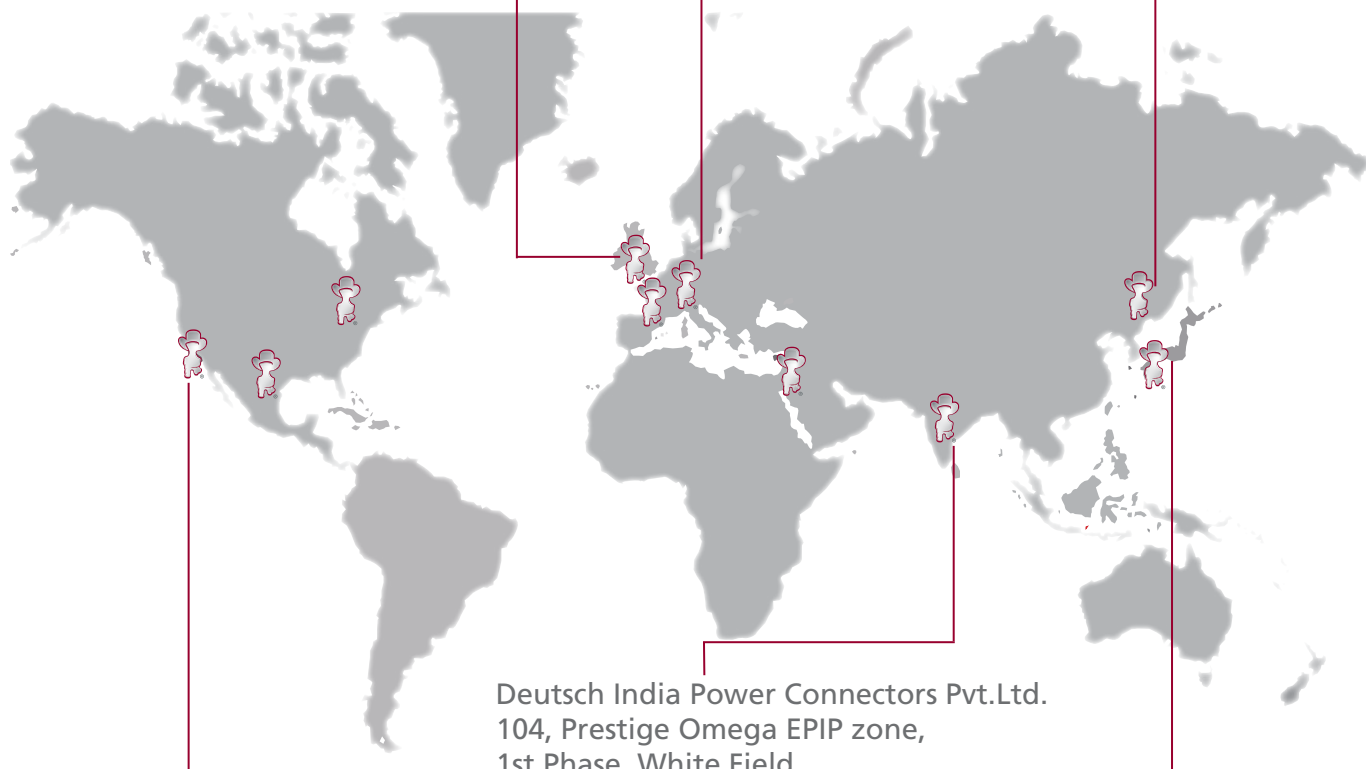

Deutsch Industrial US
3850 Industrial Ave.
Hemet, CA 92545
USA
Ph. +1 (951) 765-2250
Fax +1 (951) 765-2255
insidesales-ipd@deutsch.net

Deutsch India Power Connectors Pvt.Ltd.
104, Prestige Omega EPIP zone,
1st Phase, White Field,
Bangalore - 560 066.
INDIA.
Ph: +91 80 40466525
Mobile: +91 98454 03301

Deutsch Japan Ltd.
4-3-28 Nishidai
Itabashi-ku, Tokyo 175-0045
Japan
Ph. +81-3-5922-1345
Fax +81-3-5995-1341
tnawa@nihon-deutsch.co.jp



DEUTSCH
INDUSTRIAL

3850 Industrial Avenue, Hemet, California 92545 Tel.: (951) 765-2250 - Fax: (951) 765-2255
Web: www.deutsch.net - Edition 2/2009

A STEP AHEAD



DEUTSCH

INDUSTRIAL

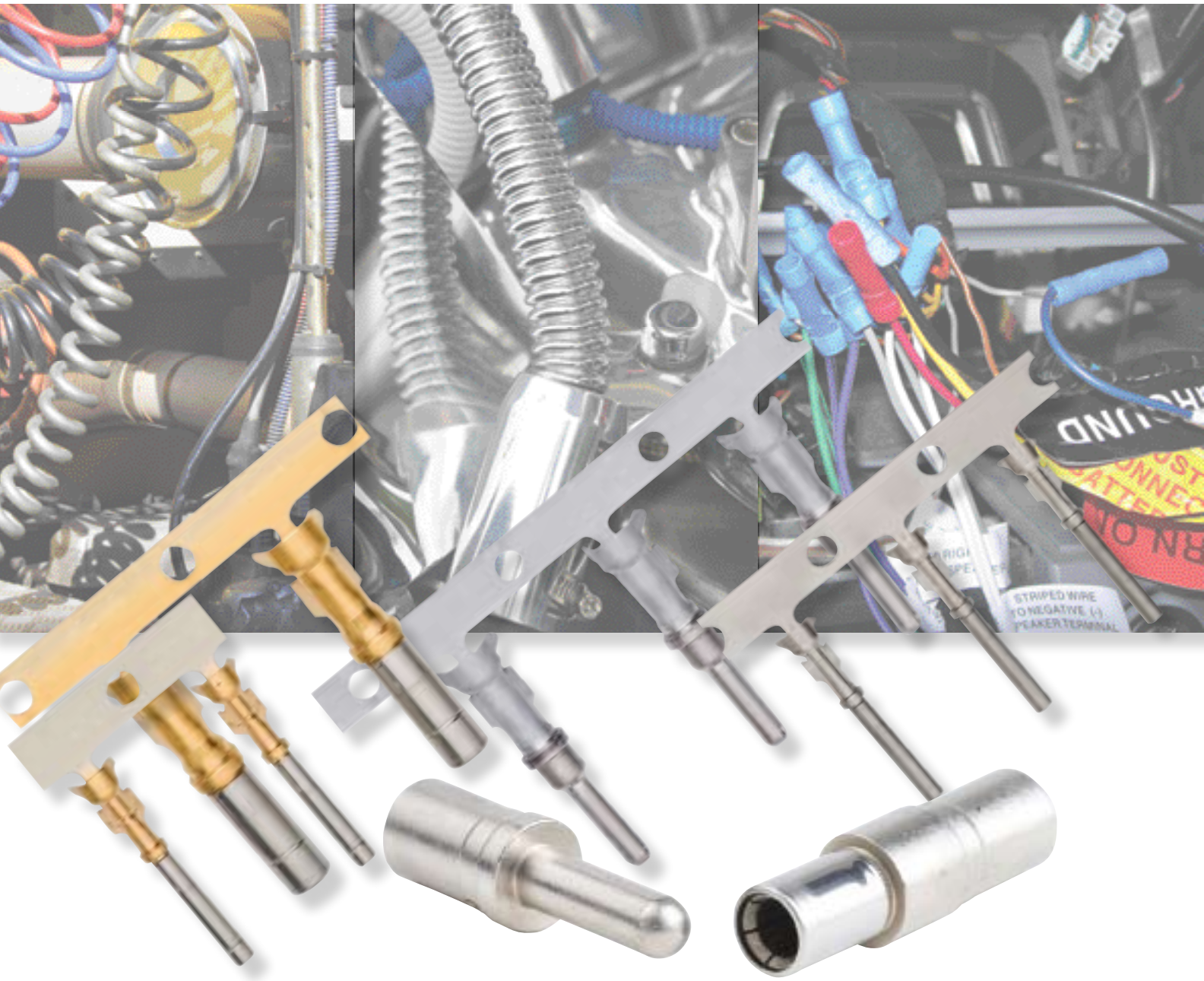

Common Contact System Technical Manual

A STEP AHEAD



Introduction	1
Contents	1
Common Contacts	1-5
Crimp Information	3-4
General Specifications	5
Stamped & Formed Contacts	6, 9-10
Solid Contacts	7-8
Crimping Instructions	7-9
P.C.B. Pins	11
Contact Glossary	12-14

COMMON CONTACT SYSTEM

Deutsch manufactures two product styles of contacts, stamped and formed and solid. Within each style is a separate and distinct manufacturing process that allows the widest application with any Deutsch Industrial connector series.

Deutsch stamped and formed contacts are designed for use where wire termination costs are of primary concern without sacrificing reliability of electrical circuits. The stamped and formed contact series is made on a precision stamping machine using flat strip stock, then a durable and corrosion proof nickel plating is applied. Gold is an optional finish. All Deutsch Industrial terminals protect the split socket tines with a closed entry stainless steel sleeve or sleeveless design. The stamped and formed contact style is sold on reels.

The Deutsch solid contact series is designed for use for larger wire size and heavy duty applications. This style of contact is manufactured using a cold heading process and solid copper alloy wire. The resulting contact is a closed entry design. The standard finish is nickel, with gold plating an option. All Deutsch Industrial terminals protect the split socket tines with a closed

entry stainless steel sleeve. The solid style of contact is sold in bulk.

Both contact styles terminate to wire using crimp type technology. The only variations in Deutsch's common contact systems are those dictated by wire gauge and contact style.

COMMON CONTACTS

The word "common" describes the Deutsch contact system well. Solid and stamped contacts can be used interchangeably in any Deutsch connector.

The stamped and formed style includes 10 sizes each of pin and socket contacts that terminate 10-22AWG (5.0 - 0.35mm²). The specific contact is determined by the outside diameter of wire insulation and conductor size. See the appropriate chart on page 5 of this manual for specific part numbers.

The solid style contact terminates wire from 6 AWG to 20 AWG (13 - 0.5mm²). The solid style is available in 6 sizes each of pin and socket. The applicable contact is determined by the size of the conductor only. See the appropriate chart on page 7 of this manual for specific part numbers.

The selection of Deutsch Industrial connectors insures that the contact termination system will be compatible. This reduces changes in the assembly of the wire harness. It also improves performance, reliability and maintainability. Critical functions to any electrical system. The use of a common contact system eliminates many of the failures reported in harnesses where hundreds of different terminations are used. The end result of selecting Deutsch is increased profits and long term performance.





SOLID CONTACTS

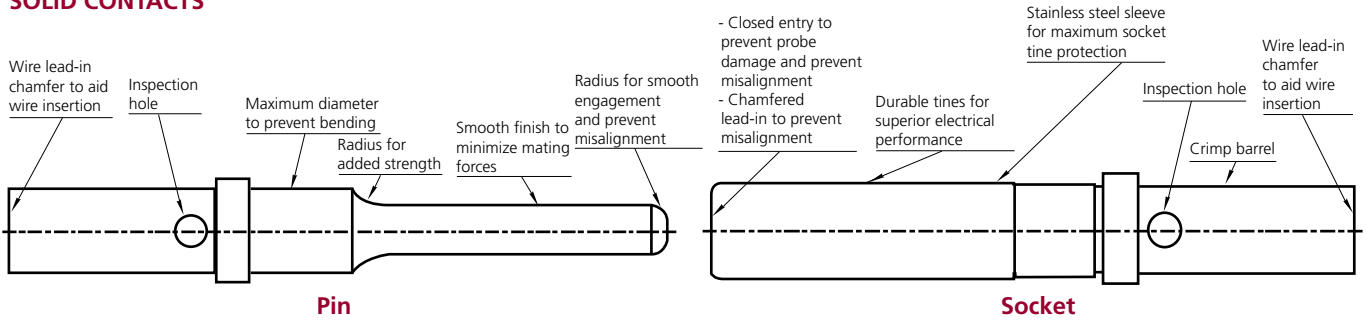

Material:

Solid copper alloy

Termination Method:

Crimp

Manufacturing Method:

Cold-headed

Finish-Standard:

Nickel plated

Finish Options:

a) Gold

- Solid shoulder for high tensile strength pin retention.
- Nickel plated as standard for corrosion resistance.
- Inspection hole for conductor strand visibility.
- Insulation cup not required due to integral wiring sealing connector grommet design.

- Solder is not used, eliminating flux corrosion and reducing assembly costs.
- Wire entry chamfer for all wire sizes.
- No retention tangs required, eliminating contact damage and the need for secondary locks.

Material:

Solid copper alloy

Termination Method:

Crimp

Manufacturing Method:

Cold-headed

Finish-Standard:

Nickel plated

Finish Options:

a) Gold

STAMPED CONTACTS

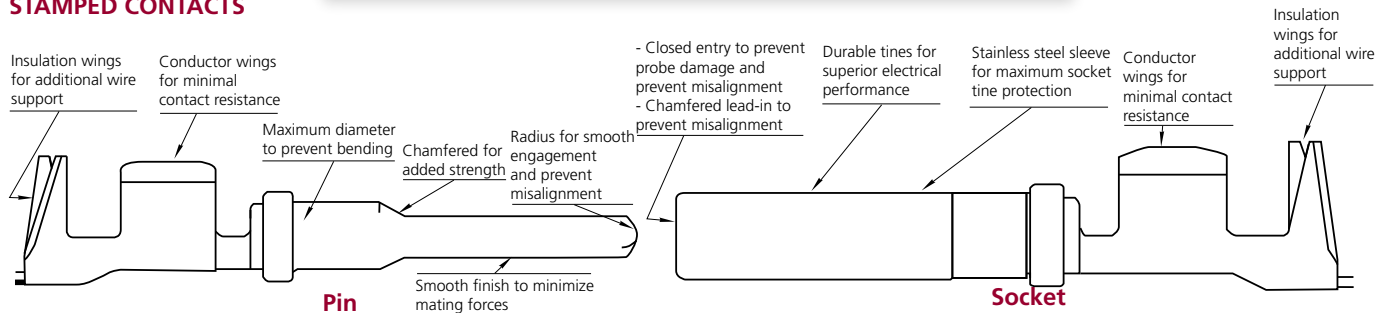

Material:

Flat strip copper alloy

Termination Method:

Crimp

Manufacturing Method:

Stamped & Formed

Finish-Standard:

Nickel plated Size 16 & 20

Tin/Nickel Size 12

Finish Options:

a) Gold

Material:

Flat strip copper alloy with

stainless steel sleeve

Termination Method:

Crimp

Manufacturing Method:

Stamped & Formed

Finish-Standard:

Nickel plated Size 16 & 20

Tin/Nickel Size 12

Finish Options:

a) Gold

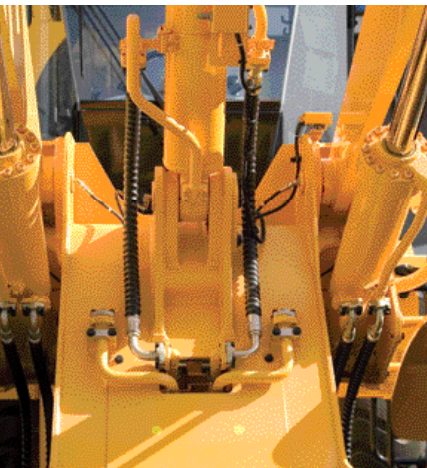



DEFINITION

Crimping may be defined as the act of joining a conductor to a pin or socket contact using a mechanical tool to compress and displace metal. In a good crimp joint, there is a mutual flow of metal, causing a symmetrical distortion of wire strands and contact material. Such a joint is similar to a cold weld. Mechanical strength and good electrical conductivity are established.

Because of the new environments to which electrical connectors are subjected, there has been a drastic change in thinking relative to the use of precision crimp joints in preference to solder.

CRIMPING CONFIGURATIONS

Stamped contacts use a folded type of crimp (Fig. 1). Solid contacts use 2, 4, or 8 indents (Fig. 2). The wire strands and the contact material are formed together in a solid mass with reduction of area of the wire strands. A minimum of voids exists.

CRIMPING CHARACTERISTICS

Connectors utilizing either style of Deutsch crimped contacts permit the removal of these contacts several times. Modification, circuit changes, or replacement of contacts may be made with the same quality assurance as in production line assembly. Crimping may be accomplished either with hand tools, power tools or automated power tools.

CRIMPED CONTACTS

Mechanically crimping contacts is now the dominant wire termination method, for some very good reasons:

- 1) Since no wet process is involved, corrosion is not a problem. No adhesives, fluxes or additives are used.
- 2) Strength, accuracy and over-all reliability of a crimped contact are controlled by the crimp tool, not the operator. The field tools (except #4 solid style) release the contact only after the full crimping cycle is completed. The tools are relatively inexpensive.
- 3) With smaller wire, the crimp is as strong as the wire itself.
- 4) The joint can be inspected visually. Viewing the wire through an inspection hole in the contact makes inspection quick,

easy and sure, both by the operator and by the inspector.

- 5) The crimping tool is universal, it accepts both pins and sockets of many types.
- 6) Plating thickness is not restricted, as in solder joints, so better corrosion resistance and contact reliability are achievable.
- 7) Crimping can be done anywhere even in the field, without special preparation. Terminations are replaced or modified in the field exactly as in the shop, using the same tools and the same techniques, and with the same ease of operation and certainty of results.

8) Total installed and maintenance costs are lower since joining is quick and easy.

Crimp Tensile Test

The following information is provided as an aid to manufacturing facilities that terminate Deutsch crimp type contacts. The term "typical" is used to illustrate expected tensile strength results when crimp tooling is in good working order and properly calibrated. The term "minimum" is used to illustrate a point at which tooling is suspected of having excessive wear, insufficient air pressure, bad calibration, etc. Minimum does not imply that the crimp is unacceptable, only that an adjustment should be made.

The manner in which the tensile test is performed is important in order to attain valid test results. An axial load should be applied at a rate of 1.0 in./min starting from zero pounds until there is wire/contact separations or wire breaking. Care should be taken to avoid clamping on the crimp barrel.



CRIMP TENSILE STRENGTH (STAMPED CONTACTS)

#20 SIZE	10-20 lbs.
#16 SIZE	15-25 lbs.
#12 SIZE	70 lbs.

(SOLID CONTACTS)

#20 SIZE	20 AWG	20 lbs.
#16 SIZE	16 AWG	20-70 lbs.
#12 SIZE	12 AWG	70-75 lbs.
# 8 SIZE	8 AWG	90-125lbs.
# 4 SIZE	6 AWG	300 lbs.

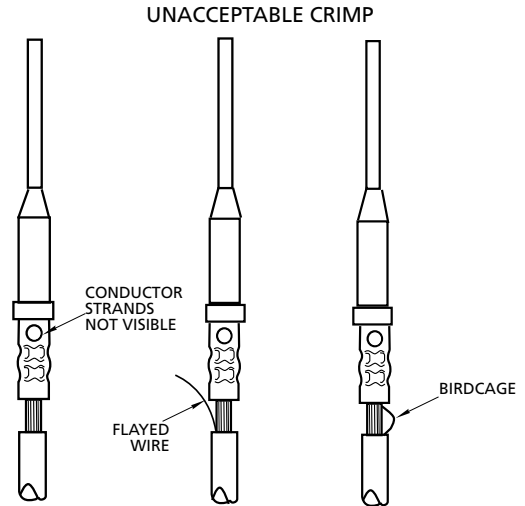
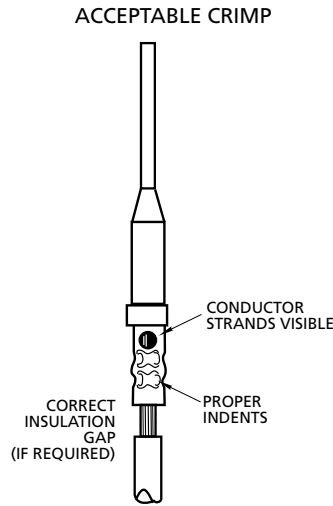

CRIMP INSPECTION

Crimping tools are, in some case, more expensive than soldering tools, but this is more than off-set by the lower total installation and maintenance costs resulting from the crimping operation. However, controls are required to make sure first, that the operator uses the proper crimping tools designed for the type and size contact being crimped, and then, that the pin or socket is properly inserted into the tool. The wire must be stripped of insulation and fully inserted into the contact. The usual procedure is to insert the wire into the open end of the contact, then close the crimping tool, thus crimping the wall of the contact into the wire at several points around the circumference.

When completed, correct assembly can be checked visually. The removed insulation should expose a conductor length that will pass beyond the inspection hole in the contact and still reveal .025 - .100 (.063 - 2.54) of conductor between the contact and the insulation on the wire. The operator and inspector can thus check for:

- 1) Damaged wire strands.
- 2) Missing wire strands.
- 3) Wire strands not entering the contact barrel.
- 4) Wire not inserted to the proper depth in the contact.

When the correct tool is used for crimping, a good termination is assured.

For more detailed crimp dimensions please request a factory drawing. For Stamped and Formed Style see 0425 -*** - 0000. For Solid Style see 0425-205-0000.

COMMON TOOLING

By selecting the Deutsch common contact system, only one style of tool is needed to remove wires. In designs like the DT and DTM Series connectors, even this tool is eliminated. Hand crimp tools are used to crimp different types of contacts to the wire end. For automation, semi and full automatic crimping equipment is available that will process thousands of wire terminations per hour.

COMMON PROCESSING

Using the Deutsch contact means that the way an O.E.M. supplier attaches a wire to this terminus never varies. This procedural standard allows harness assemblers to become highly proficient in terminating Deutsch connectors.

SOLID TYPE

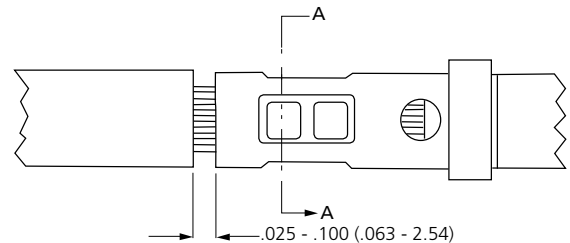

STAMPED AND FORMED TYPE

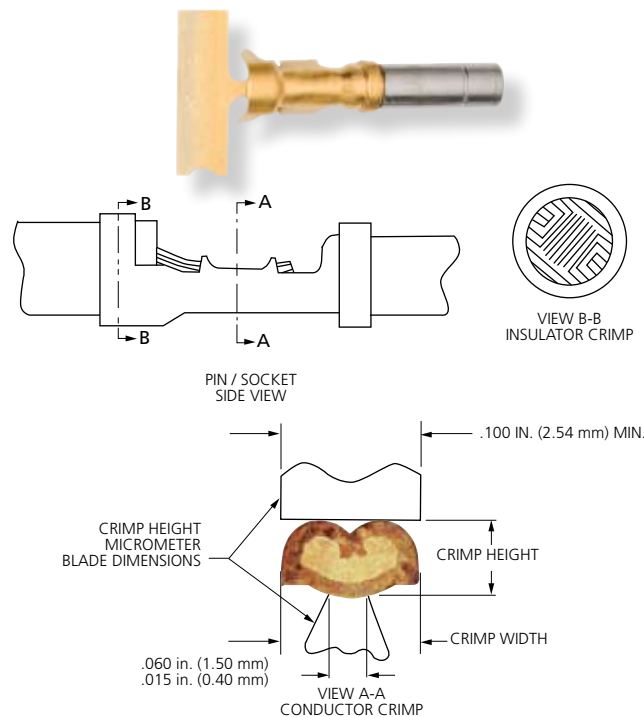



GENERAL SPECIFICATIONS

Solid Contacts

Pin: Copper alloy
 Socket: Copper alloy with stainless steel sleeve
 Finish: Nickel plating
 Optional: Gold plating is available for dry circuit applications

Stamped & Formed Contacts

Pin: Copper alloy
 Socket: Copper alloy with stainless steel sleeve
 Finish: Nickel plating
 Optional: Gold plating is available for dry circuit applications

Dielectric Withstanding Voltage

Current leakage less than 2 milliamps at 1500 VAC.

Insulation Resistance:

1000 megohms minimum at 25° C.

Current Rating (Contact current rating @ 125° C (continuous))

- Size 20: 7.5 amps
- Size 16: 13 amps
- Size 12: 25 amps
- Size 8: 60 amps
- Size 4: 100 amps

Submersion:

Properly wired and mated connection will withstand immersion under three feet of water without loss of electronic qualities or leakage.

Fluid Resistance:

Connectors show no damage when exposed to most fluids used in industrial applications.

Vibration:

No unlocking or unmating and exhibits no mechanical or physical damage after sinusoidal vibration levels of 20 G's at 10 to 2000 Hz in each of the three mutually perpendicular planes. No electrical discontinuities longer than 1 microsecond.

Temperature:

Operative at temperatures from -55°C to +125° C. Continuous at rated current.

Contact Retention:

Contacts withstand a minimum load of:

- 20 lbs. (89N) for size 20
- 25 lbs. (111N) for size 16
- 30 lbs. (133N) for size 12
- 35 lbs. (156N) for size 8
- 35 lbs. (156N) for size 4

Thermal Cycle:

No cracking, chipping or leaking after 20 test cycles from -55° C to +125.

Durability:

No electrical or mechanical defects after 100 cycles of engagement and disengagement.

CONTACT RESISTANCE				
CONTACT SIZE	WIRE GAUGE AWG(mm ²)	TEST CURRENT (AMPS)	RESISTANCE (mV) SOLIDS	RESISTANCE (mV) STAMPED & FORMED
20	22 (.35)	5.0	60	100
	20 (.50)	7.5	60	100
	18 (.80)	7.5	60	100
16	16 (1.0)	7.5	60	100
	20 (.50)	7.5	60	100
	18 (.80)	10	60	100
12	16 (1.0)	13	60	100
	14 (2.0)	13	60	100
	12 (3.0)	25	60	100
8	10 (5.0)	25	N/A	100
	8 (8.60)	60	60	N/A
	10 (5.60)	60	60	N/A
4	6 (13.0)	100	60	N/A

WIRE SEALING RANGE		
CONTACT SIZE	RECOMMENDED WIRE INSULATION O.D.	
	N-SEAL	E-SEAL
#20	.053 - .120 (1.35 - 3.05)	N/A
#16	.088 - .145 (2.24 - 3.68)	.053 - .120 (1.35 - 3.05)
#12	.134 - .170 (3.40 - 4.32)	.097 - .158 (2.46 - 4.01)
#8	.190 - .240 (4.83 - 6.10)	N/A
#4	.280 - .292 (7.11 - 7.42)	N/A



STAMPED AND FORMED

Deutsch Stamped and Formed contacts are designed for use where wire termination costs are of primary concern without sacrificing reliability of electrical circuits.

DESIGN AND MATERIALS SELECTION

Deutsch engineers have combined the process of superior material selection with outstanding mechanical Cad-Cam Designs to present stamped and formed contacts that exceed the demands of today's truck and off-highway electrical systems.

The selection of copper alloys, finished after forming with nickel plating provides superior durability, performance, corrosion and oxidation resistance.

To achieve air-tight crimps that eliminate the need to solder after wire terminations, Deutsch engineers have specified that the core-wing ends be formed in the direction of the crimp, thus assuring resistance to crimp relaxation and displacement of metal, crimp after crimp.

Deutsch socket tines are protected by a closed entry stainless steel sleeve, to ensure controlled contact pressure for maximum conductivity with minimum surface wear.

In keeping with the Deutsch commitment to total quality, all stamped and formed contacts are manufactured using SPC controls and are subjected to extensive programs of rigid testing, including field performance feedback.

FEATURES	BENEFITS
Stainless Steel Socket Sleeve	Provides closed entry design preventing probe damage.
Contact Tines are in Socket Member, Not Pin	Terminal contact points are protected from handling and assembly damage.
No Lances / Tangs	Contact retention is designed in the connector body, eliminating retention problems during handling and rework.
Bullet (rounded) Pin Nose	Prevents mismatching and bent pins.
Nickel Plating	Reduces oxidations, thus improving conductivity performance.
Plated After Forming	No base metal is exposed to corrosion.
Optional Gold Plating	Available for dry circuit application.
No Individual Wire Seal Grommets	Wire seals are designed as an integral component of the connector, thus reducing wire terminating costs.
Pre-Bent or Compound Arch Core Wings	Provides an air-tight crimp joint.
Improved Die Stop Gap	Allows application die to position wire for proper crimp length.
Off-Set Configuration	Provides center wire alignment between conductor and insulation.
Copper Alloy Materials	Prevents material relaxation over time, providing reliable crimp joints and increased durability.

Stamped & Formed Contacts

SIZE	STAMPED & FORMED CONTACT PART NUMBERS		CARRIER STRIP IDENTIFICATION	WIRE SIZE AWG (mm ²)	WIRE INSULATION O.D. RANGE	RECOMMENDED STRIP LENGTH INCHES (mm)	MIN CONT. RETENTION LBS (N)	MAX RATED AMPS AT 125°C CONTINUOUS
	PIN	SOCKET						
20	1060-20-01**	1062-20-01**	20 - 01	16 - 22 (1.5 - 0.35)	.075 - .125 (1.91 - 3.15)	.150 - .200 (3.81 - 5.08)	20 (89)	7.5
20	1060-20-02**	1062-20-02**	20 - 02	16 - 22 (1.5 - 0.35)	.051 - .085 (1.30 - 2.16)	.150 - .200 (3.81 - 5.08)	20 (89)	7.5
20	N/A	1062-20-03**	20 - 03	16 - 22 (1.5 - 0.35)	.075 - .125 (1.91 - 3.15)	.150 - .200 (3.81 - 5.08)	20 (89)	7.5
20	1060-20-06**	1062-20-06**	20 - 06	14 - 16 (2.5 - 1.0)	.075 - .125 (1.91 - 3.15)	.150 - .200 (3.81 - 5.08)	20 (89)	7.5
16	1060-14-01**	1062-14-01**	14 - 16	14 - 18 (2.0 - .75)	.095 - .150 (2.41 - 3.81)	.150 - .200 (3.81 - 5.08)	25 (111)	13
16	1060-14-10**	1062-14-10**	14 - 16	14 - 16 (2.0 - .75)	.095 - .150 (2.41 - 3.81)	.150 - .200 (3.81 - 5.08)	25 (111)	13
16	1060-16-01**	1062-16-01**	16 - 18	14 - 18 (2.0 - .75)	.075 - .140 (1.91 - 3.55)	.150 - .200 (3.81 - 5.08)	25 (111)	13
16	1060-16-06**	1062-16-06**	0.5 - 1.0	16 - 20 (1.0 - 0.50)	.055 - .100 (1.40 - 2.54)	.150 - .200 (3.81 - 5.08)	25 (111)	13
16	1060-16-07**	1062-16-07**	0.75 - 2.0	14 - 18 (2.0 - .75)	.075 - .140 (1.91 - 3.55)	.150 - .200 (3.81 - 5.08)	25 (111)	13
16	1060-16-09**	1062-16-09**	16 - 18	14 - 18 (2.0 - .75)	.075 - .140 (1.91 - 3.55)	.150 - .200 (3.81 - 5.08)	25 (111)	13
16	1060-16-12**	1062-16-12**	1.0 - 2.5	12 - 16 (2.5 - 1.0)	.075 - .140 (1.91 - 3.55)	.175 - .225 (4.45 - 5.72)	25 (111)	13
16	N/A	1062-16-14**	14 - 16	12 - 16 (2.5 - 1.0)	.075 - .140 (1.91 - 3.55)	.175 - .225 (4.45 - 5.72)	25 (111)	13
12	1060-12-01**	1062-12-01**	12 - 14	12 - 14 (4.0 - 2.0)	.113 - .176 (2.87 - 4.47)	.225 - .275 (5.72 - 6.991)	30 (134)	25
12	1060-12-02**	1062-12-02**	10 - 12	10 - 12 (6.0 - 4.0)	.140 - .204 (3.56 - 5.18)	.225 - .275 (5.72 - 6.99)	30 (134)	25

** = Plating Codes Consult factory for custom finish needs.

For 12 Size, see 0425-041-0000 and 0425-208-0000

For 16 Size, see 0425-039-0000, 0425-059-0000, and 0425-203-0000

For 20 Size, see 0425-059-0000 and 0425-207-0000



CONTACTS AND APPLICATION DATA

Solid Contacts

SIZE	SOLID CONTACT PART NUMBERS		WIRE SIZE AWG (mm ²)	RECOMMENDED STRIP LENGTH INCHES (mm)	MIN CONTACT RETENTION LBS (N)	REF CRIMP TENSILE LBS (N)	MAX RATED AMPS AT 125°C CONTINUOUS *
	PIN	SOCKET					
20	0460-202-20**	0462-201-20**	20 (0.50)	.156-.218 (3.96 - 5.54)	20 (89)	20 (89)	7.5
20	0460-010-20**	0462-005-20**	16-18 (1.0 - 0.75)	.156-.218 (3.96 - 5.54)	20 (89)	20 (89)	7.5
16	0460-202-16**	0462-201-16**	16-20 (1.0 - 0.50)	.250 - .312 (6.35 - 7.92)	25 (111)	35-20 (156-89)	13
16	0460-215-16**	0462-209-16**	14 (2.0)	.250 - .312 (6.35 - 7.92)	25 (111)	70 (311)	13
12	0460-204-12**	0462-203-12**	12-14 (3.0 - 2.0)	.222 - .284 (5.64 - 7.21)	30 (134)	75-70 (334 - 311)	25
8	0460-204-08**	0462-203-08**	8-10 (8.0 - 5.0)	.430 - .492 (10.92 - 12.50)	35 (156)	125-90 (556-400)	60
4	0460-204-04**	0462-203-04**	6 (13.0)	.430-.492 (10.92-12.50)	35 (156)	300 (1334)	100

* See Information Drawing 0425-205-0000. Consult factory for alternate finishes.

* Deutsch can only warrant electrical performance when proper parts, procedures and tooling from approved Crimp Termination Information Drawings are Used.

SOLID CONTACTS

Universal Hand Crimp tool

HDT - 48 - 00

For size 20, 16 & 12 contacts



- 1) Strip specified length of insulation from wire
- 2) Raise selector knob and rotate until arrow is aligned with wire size to be crimped.
- 3) Loosen lock nut, turn adjusting screw in until it stops.

- 4) Insert contact, turn adjusting screw counter clockwise out until contact is flush with indenter cover. Tighten lock nut.



- 5) Insert wire in contact, contact must be centered between indenters, close handles until handle contacts the stop.
- 6) Release handles and remove crimped contact.

- 7) Inspect terminal to insure that all strands are in crimp barrel.

Note; tool must be readjusted for each type/size of contact or wire.



"Field Maintenance" Hand Crimp Tools



HDT - 48 - 00

For size 20, 16 & 12 solid contacts

HDT - 04 - 08

For size 4 & 8 contacts
Field repair tool only. Not for
production use.



Production Crimp Tools



Power Crimp Equipment

HDP - 400

For size 4, 8, 12, 16 & 20 solid contacts



Automatic Crimp Equipment

HD16 - P/S accommodates 16 contacts

HD12 - P/S accommodates size 12 contacts

HD12-16 P/S accommodates size 16 & 12 contacts

Consult factory for availability and sources



CRIMPING

WIRE STRIPPING



CRIMP INSPECTION

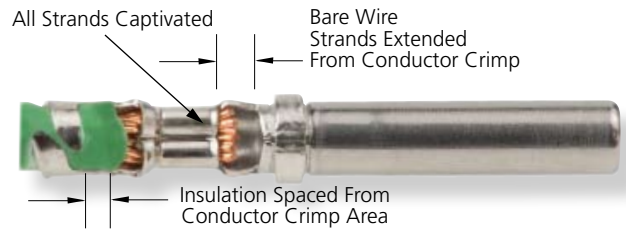

For crimp configuration refer to drawing 0425-2**-0000

HAND CRIMP TOOLING



APPLICATION DIES

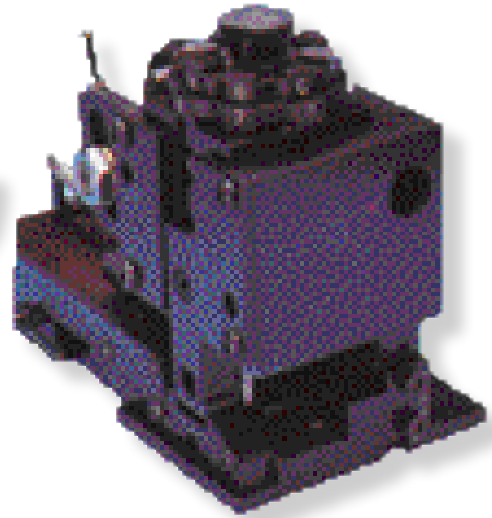

HAND TOOL

Field Maintenance

Ratched design for full cycle crimp reliability

- DTT - 12 - 00
- DTT - 12 - 01
- DTT - 16 - 00
- DTT - 16 - 01
- DTT - 16 - 02
- DTT - 20 - 00
- DTT - 20 - 02
- DTT - 20 - 03

*See information drawing for proper tool.

*Deutsch can only warrant electrical performance when proper parts, procedures and tooling from approved Crimp Termination Information Drawings are used.

FITS ALL STANDARD PRESSES

- DCT12 - 02 - 00
- DCT12 - 02 - 01
- DCT16 - 02 - 00
- DCT16 - 02 - 01
- DCT1620 - 02 - 00
- DCT20 - 02 - 00

Consult factory for further application information.



Hand Crimping Instructions for Stamped Contacts



1. Cycle the hand tool to the open position.
2. While pressing upward on the locator spring, insert the contact with the tails upward completely into the locator.



3. When correctly positioned, the contact should be located beyond flush with the edge of the hand tool and positioned on the concave polished split level crimp areas.

4. Insert the prestripped wire into the crimp area of the contact and completely cycle the tool.

5. While pressing upward on the locator spring withdraw the crimped termination.



6. The result will be a perfect termination.

7. Note that there are no unterminated wire strands, and that some strand ends can be seen at the forward edge of the crimp. Also note the insulation is gripped by the smaller secondary crimp. Distortion is at a minimum.



P.C.B. Pins

In many electronic module designs, the use of removable contacts provides solutions of design flexibility and reduced costs. Deutsch Industrial has available a complete line of straight-reduced diameter extended pins that may be installed in any of the Deutsch family of field serviceable connectors. These solid copper alloy pins may be specified in various platings and assembled in HD30, HDP20, HD10, DRC or DT receptacles. By utilizing the tooled and readily available insert arrangements of these five connector series, the electronic designer is provided a low cost alternative to meet his application needs. Consult the Deutsch Industrial series catalogs for a complete review of connector types and insert arrangements offered.

Material
Copper alloy

Plating
90: Tin
31: Gold

P.C.B. Mounting
Consult factory for P.C.B. mounting details and pin positions.

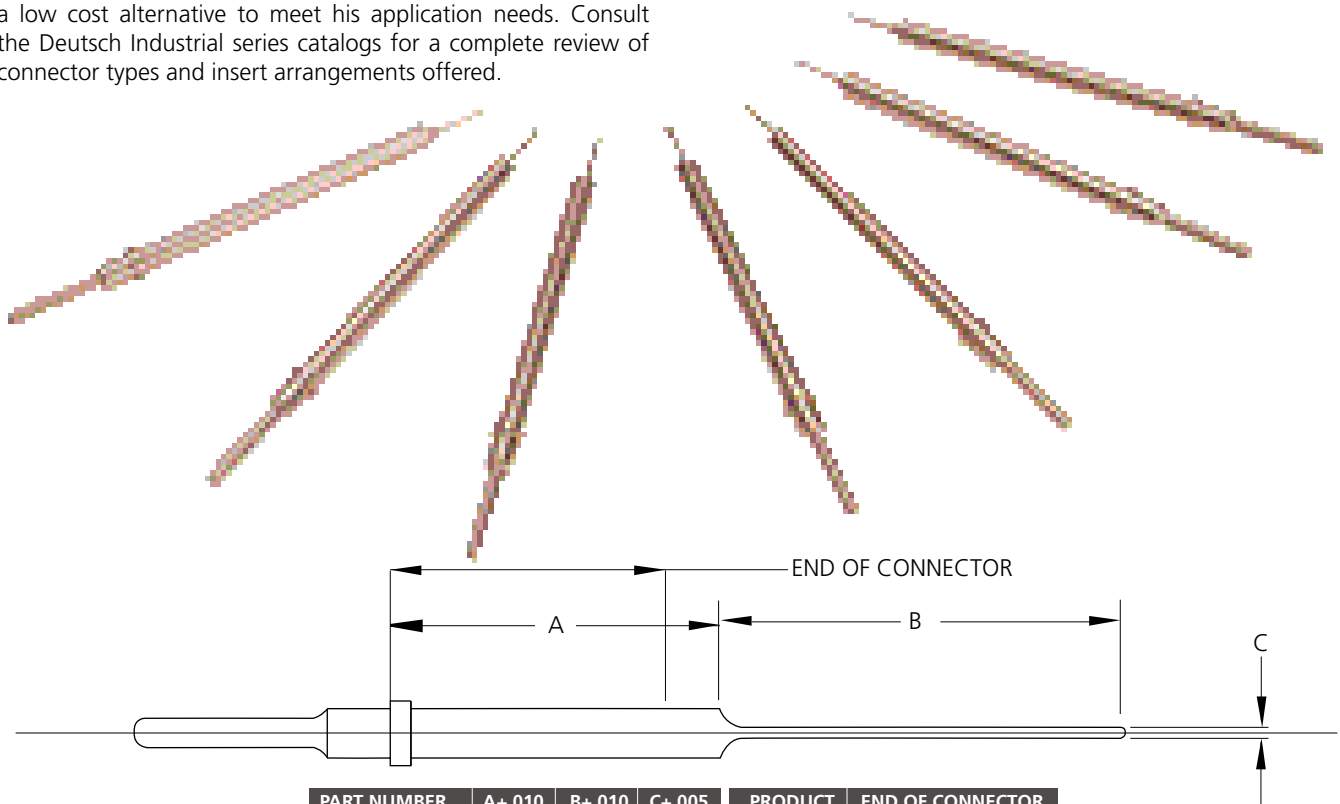

PART NUMBER	A+.010	B+.010	C+.005	PRODUCT	END OF CONNECTOR
0460-208-16**	1.300	.248	.025	HD30	.939
0460-229-16**	.545	.248	.025	HD10	.925
0460-238-12**	.714	.549	.043	DT	.777
0460-241-16**	1.305	.160	.040	DT04-2P	.677
0460-245-16**	.976	.400	.041	DT04-3P	.677
0460-245-12**	1.024	.500	.041	DRC	1.063
0460-257-16**	.793	.248	.025		
0460-208-12**	1.305	.248	.025		
0460-263-16**	1.305	.248	.093		

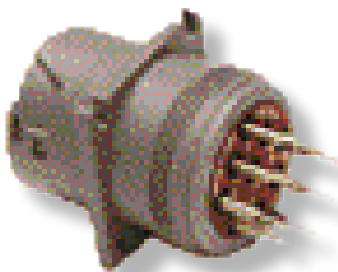

11 HD10 Series

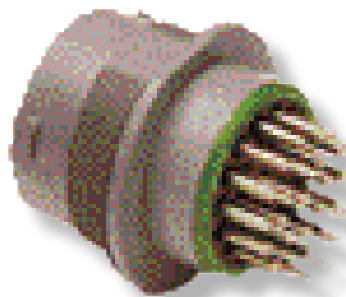

HDP20 Series

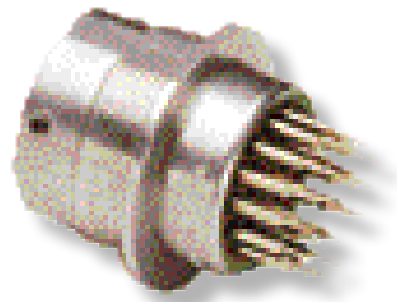

HD30 Series



Contact Glossary

AWG American Wire Gage - Reference National Bureau of Standards Copper Wire Table (Handbook 100) AVS.

Barrel - (1) Conductor barrel: the section of the terminal, splice or contact that accommodates the stripped conductor, or (2) Insulation barrel: The section of the terminal splice or contact that accommodates the conductor insulation.

Barrel Chamber - The bevel at the end of the conductor barrel providing for easier entry.

Belled Mouth (bellmouth) - The flared or wide entrance of a terminal, splice or contact barrel to permit easier insertion of the conductor.

Bifurcated Contact - Describes lengthwise slotting of a flat spring contact as used in a printed circuit edge connector.

Circumferential Crimp - The type of crimp where the crimping dies completely surround a barrel resulting in symmetrical indentations in the barrel.

Closed Entry - A contact or a contact cavity design in the insert or body of the termination assembly which limits the size and position of the mating contact or printed circuit board to a predetermined dimension.

Contact - The conductive element in a termination assembly which mates with a corresponding element for the purpose of transferring electrical energy.

Contact, Bellows - A contact in which a multileaf spring is folded. This provides more uniform spring rate over the full tolerance range of the mating unit.

Contact, Crimp - A contact whose conductor barrel is a hollow cylinder accepting the conductor. After a bared conductor is inserted, a crimping tool is applied to swage or form the contact metal firmly against the conductor. An excellent mechanical and electrical contact results. Often referred to as a solderless contact.

Contact, Dressed - A contact with a permanently attached contact retaining member.

Contact, Female - A contact into which the mating contact is inserted. Similar in function to a socket contact.

Contact, Fixed - A contact permanently included in the insert material. It is mechanically locked, cemented or embedded in the insert.

Contact, Insertable / Removable - A contact that can be mechanically joined to or removed from an insert. Usually special tools lock the contact in place or remove it for repair or replacement.

Contact, Male - A contact of design to make contact by insertion into a mating contact. Similar in function to a pin contact.

Contact, Nude - A contact with a contact retainer that remains in the insert at all times.

Contact, Open Entry - A socket whose engaging end is split and therefore vulnerable to distortion or damage from test probes or other wedging devices.

Contact, Pin - Male-type contact designed to fit inside the mating female contact member.

Contact, Sheet-Metal - Contacts made by stamping and bending sheet metal rather than by the machining of metal stock.

Contact, Socket - A female-type contact (usually completely surrounded by insert material).

Contact, Solder - A contact which has a cup, hollow-cylinder eyelet or hook to accept a conductor and retain the applied solder.

Contact Area - The area in contact between two conductors, two contacts or a conductor and a contact permitting the flow of electricity.

Contact Arrangement - The number, spacing and arrangement of contacts in a termination assembly.

Contact Engaging and Separating Force - Force needed to either engage or separate mating contacts.

Contact Float - The overall side play and/or angular displacement of contacts within the insert cavity.

Contact Inspection Hole - A hole in the cylindrical rear portion of contact used to check the depth to which a conductor has been inserted. Crimp-type contacts usually have inspection holes; solder-types seldom do, except larger sizes in which the hole's function is to allow solder and air to bleed out during soldering.

Contact Resistance - Electrical resistance of a pair of engaged contacts. Resistance may be measured in ohms or millivolt drop at a specified current over the engaged contacts.

Contact Retainer - A device either on the contact or in the insert to retain the contact in an insert or body.

Contact Retention - The axial load in either direction which a contact can withstand without being dislodged from its normal position within an insert or body.

Contact Shoulder - The flanged portion of the contact which limits its travel into the insert.

Contact Size - An assigned number denoting the size of the contact.



Contact Spacing - The spacing between the centers of contacts within an insert.

Contact Spring - The spring placed inside the socket-type contact to force the pin into position of positive intimate contact. Depending on the application, various types are used, including leaf, cantilever, napkin, ring, squirrel cage and "Chinese-finger" springs. All perform the function of wiping and establishing good contact. Various metal alloys are used. For example, beryllium copper is used where high conductivity and long life are required. Stainless steel, while its conductivity is only about two percent is used in high temperature applications.

Contact Wipe - The distance of travel (electrical engagement) made by one contact with another during its engagement or separation or during mating or unmating of the connector halves.

Crimp - The physical compression (deformation) of a contact barrel around a conductor to make an electrical and mechanical connection to the conductor.

Crimping - a pressure method of mechanically securing a terminal, splice or contact to a conductor.

Crimping Die - Portion of the crimping tool that shapes the crimp.

Crimp Tool - Mechanism used for crimping.

Engaging and Separating Force - Force required to either engage or separate mating contacts or connectors.

Extraction Tool - A device used for extracting removable contacts from a termination assembly.

Flag Terminal - Terminal having a tongue protruding from the side of the barrel.

Flange Spade Terminal - A terminal whose tongue edges are turned at an angle to the plane of the tongue.

Grid Spaced - The arrangement of contacts in a multiple contact termination assembly by spacing in a geometric pattern.

Hermaphroditic Contact - A contact design which is neither pin nor socket and which mates with another contact of the same design. The contacts may be arranged as male and female contacts as for pins and sockets. Hermaphroditic contacts may also be used in a manner such that one half of each contact mating surface protrudes beyond the connector interface and both mating connectors are identical.

Hook Terminal - Terminal with a hook-shaped tongue.

Indenter - That part of a crimping die, usually the moving part, which indents or compresses the contact barrel.

Insertion Tool - (1) A device used to insert contacts into a connector or junction. (2) A device used to insert taper pins into taper pin receptacles.

Inspection Hole - A hole placed at one end of a barrel to permit visual inspection to see that the conductor has been inserted to the proper depth in the barrel prior to crimping. (See Contact Inspection Hole.)

Insulated Terminal - Terminal having its barrel and insulation support or grip, if used, covered with a dielectric material.

Insulation Crimp - (1) The physical deformation of an insulation sleeve covering a terminal or splice and the adjacent conductor insulation to hold the sleeve in place (2) Shape combination of insulation sleeve to terminal or splice and conductor insulation after crimping.

Insulation Grip - The portion of the barrel which is closed or compressed around the conductor insulation.

Insulation Piercing Terminal - A terminal with a device which punctures the insulation of the conductor and makes contact with or enters into the conductor.

Insulation Support - The portion of the barrel corresponding to an insulation grip except that it is not compressed around the conductor insulation.

mm2 "millimeters squared" - European Wire Size Standards (ref. DIN 72551-6 and ISO 6722-3).

Maximum Conductor Operating Temperature (MCOT) - Ambient temperature plus temperature rise due to passage of electric current.

Nest - The portion of a crimping die which supports the barrel during crimping.

Offset Terminal - Terminal whose tongue is forward of, and whose stud hole is offset from, centerline of terminal barrel.

Plating - The overlaying of a thin coating of metal on components to improve conductivity, provide for easy soldering, and prevent rusting or corrosion.

Pre-Tinned - Solder applied to either or both the contact and conductor prior to soldering.

Pull-Out Force - Force necessary to separate a conductor from a contact or terminal, or a contact from a termination assembly, by exerting a pull along the axis of the conductor and the termination.

Range, Wire - The sizes of conductors accommodated by a particular barrel. Also the diameters of insulated conductors accommodated by a sealing grommet.



Common Contact System Technical Manual

Ratchet Control - A device to ensure the full crimping cycle of crimping tools.

Sealing Plug - A plug which is inserted to fill an unoccupied contact aperture in a termination assembly. Its function is to seal all unoccupied apertures in the assembly, especially in environmental connectors or junctions.

Seamless Terminal or Splice - Terminal or splice conductor barrel made without an open seam.

Serration - Deformation of the inside surface of a conductor barrel to provide better gripping of the conductor or on the outside of the conductor body to provide better gripping of the conductor.

Service Rating - The maximum voltage or current which a termination is designed to carry continuously.

Socket Contact Sleeve - A sleeve that holds the contact spring in the correct position within the socket contact and provides a smooth exterior surface.

Solderless Connection - The joining of two metals by pressure without the use of solder, braze or any method requiring heat.

Strand - A single uninsulated wire.

Strip - To remove insulation from a connector.

Swedging - A term for crimping.

Taper Pin - A pin-type terminal having a tapered end designed to be impacted into a tapered female terminal.

Temperature Coefficient of Resistivity - The change in resistance (electrical) per degree change in temperature. (It is usually signified by the symbol for alpha.)

Terminal - A device designed to terminate a conductor in order to establish electrical connection.

Wiping Action - (See Contact Wipe.) Action of two electrical contacts which come in contact by sliding against each other.



Deutsch Industrial UK
Stanier Road
St. Leonards On Sea
East Sussex TN 38 9RF
England
Ph. 44 (0) 1424 852 722
Fax 44 (0) 1424 855 979
industrialuk@deutsch.net

Deutsch Industrial Europe
Fraunhoferstrasse 11b
82152 Martinsried
Germany
Ph. +49 (0) 89 899157-0
Fax +49 (0) 89 857 4684
info.eu@deutsch.net

Deutsch Connectors Trading
(Shanghai) Co., Ltd.
Room 1032, 10F Central Plaza,
381 Huai Hai Zhong Road,
Shanghai 200020, China
Tel/Fax: 86-21-6391 5902
E-mail: salesdichina@deutsch.net

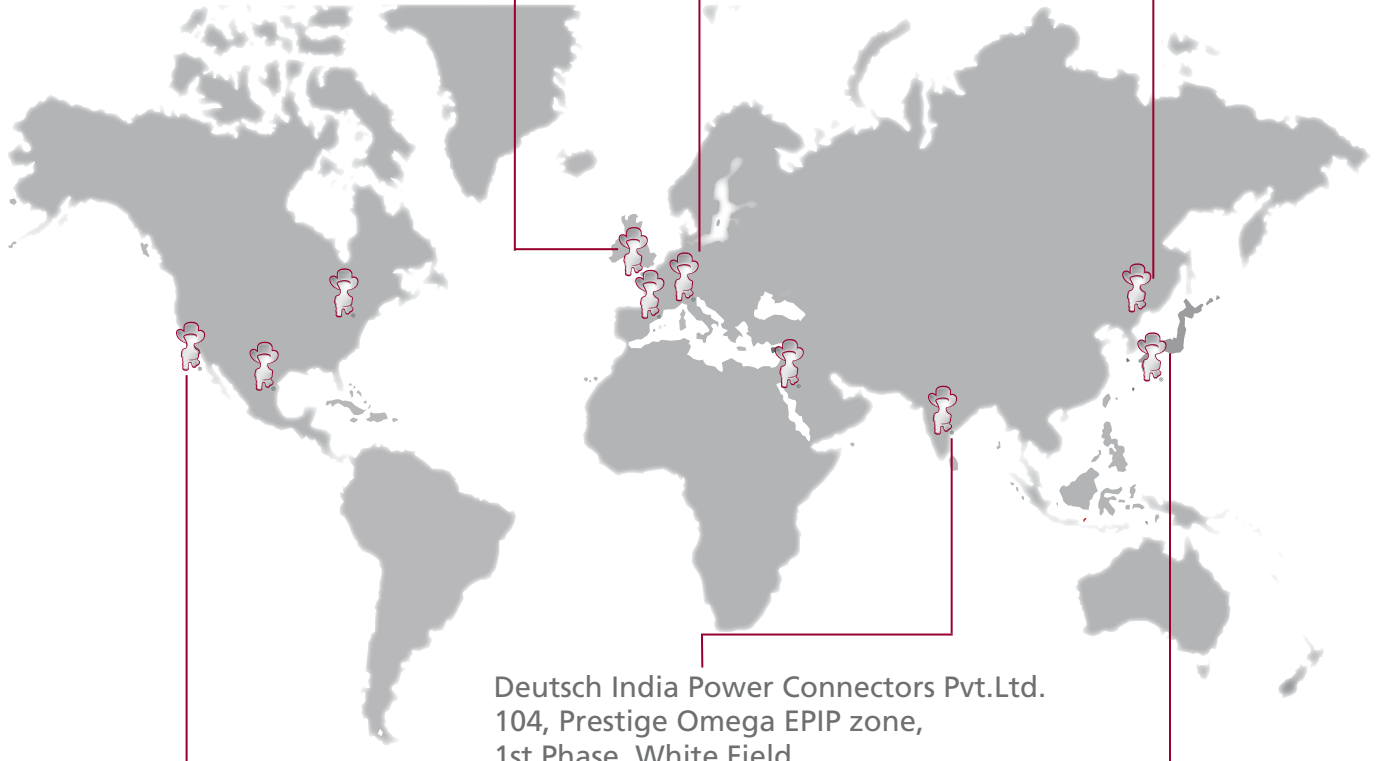

Deutsch Industrial US
3850 Industrial Ave.
Hemet, CA 92545
USA
Ph. +1 (951) 765-2250
Fax +1 (951) 765-2255
insidesales-ipd@deutsch.net

Deutsch India Power Connectors Pvt.Ltd.
104, Prestige Omega EPIP zone,
1st Phase, White Field,
Bangalore - 560 066.
INDIA.
Ph: +91 80 40466525
Mobile: +91 98454 03301

Deutsch Industrial Japan
NIHON Deutsch Ltd.
44-10, Ohyamakanai-cho
Itabashi-ku, Tokyo 173-0024
Japan
Ph. + 81-3-5995-5192
Fax + 81-305995-5193
rtakemura@nihon-deutsch.co.jp



DEUTSCH
INDUSTRIAL

3850 Industrial Avenue, Hemet, California 92545 Tel.: (951) 765-2250 - Fax: (951) 765-2255
Web: www.deutsch.net - Edition 01/2009

A STEP AHEAD



Tooling



Contents

Tooling Overview PG 132

Benefits of Crimping PG 132

Crimp Inspection PG 132

Automated Tooling PG 133-134

Hand Tools PG 135-136

Removal Tools PG 137-137

Series Specific Tools PG 138-139

How To Instructions PG 139-141

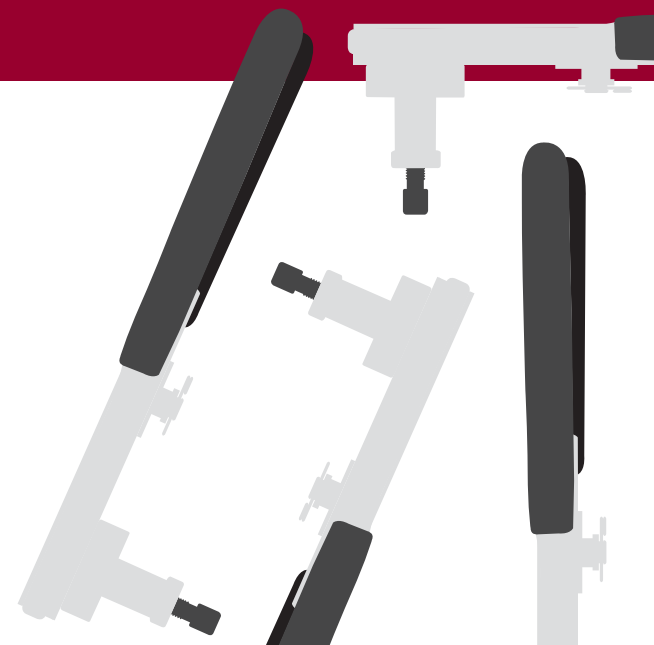



Tooling Overview

Deutsch Industrial manufactures two types of contacts, solid and stamped & formed. Both styles of contacts are designed for crimp style terminations, no solder is required or recommended. A crimp style termination displaces the wire strands creating a superior bond between the wire and the contact.

Deutsch offers several types of tools to assist with hand and production wire crimping, wire insertion and removal and wedgelock/terminal position assurance removal. The tools are specific to the solid contacts or the stamped & formed contacts. To ensure a proper crimp and achieve the highest performance specifications, Deutsch contacts must be crimped with Deutsch tooling. Deutsch can only warrant electrical performance when proper parts, procedures, and tooling are used.

■ Benefits of Crimping

Mechanically crimping contacts is the dominant wire termination method, for some very good reasons:

1. Since no wet process is involved, corrosion is not a problem. No adhesive, flux, or additives are used.
2. Strength, accuracy and overall reliability of a crimped contact are controlled by the crimp tool, not the operator. The field tools (except size 4 solid style) release the contact only after the full crimping cycle is completed.
3. The crimp tool is universal, accepts both pins and sockets of many sizes.
4. Crimping can be done anywhere, without special preparation. Terminations are replaced or modified in the field exactly the same as in the shop, using the same tools and the same techniques, and with the same ease of operation and certainty of results.
5. Total installed and maintenance costs are lower.

■ Solid Contact Crimp Inspection

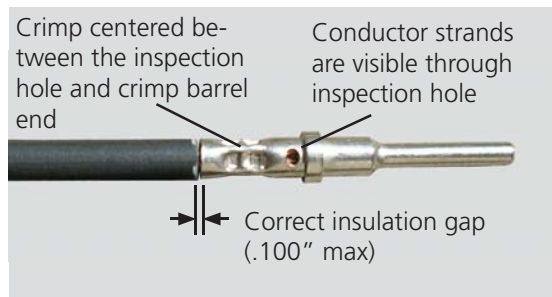

Acceptable Crimp

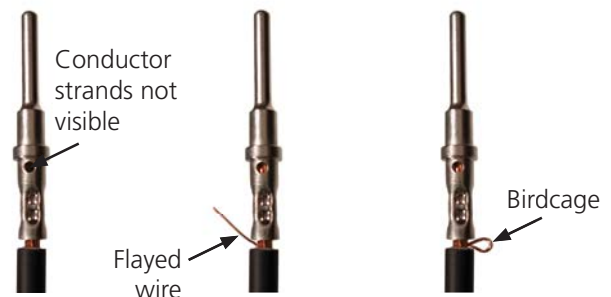

Unacceptable Crimps

■ Stamped & Formed Contact Crimp Inspection

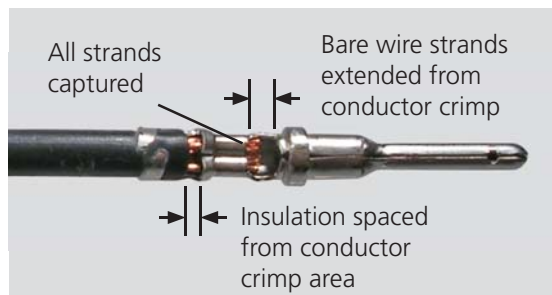

Acceptable Crimp

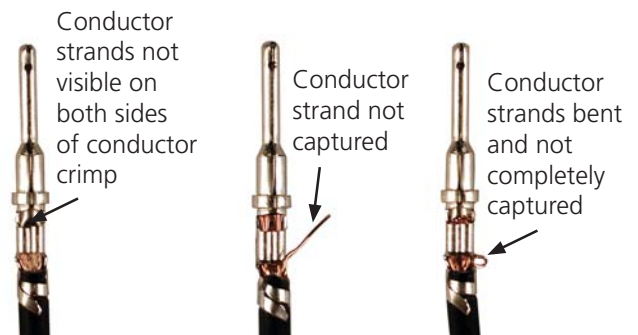

Unacceptable Crimps

Automated Tooling Overview

For higher production volumes, Deutsch offers a pneumatic power crimp tool for the solid contacts, and applicator dies for stamped & formed contacts. The HDP-400, the pneumatic solid crimp tool, is a fast, bench-top tool that crimps all of the contacts in the Deutsch Industrial Common Contact System. The HDP-400 has a foot control, and easy-to-change dies and locators for each contact size. Deutsch's stamped & formed applicator dies are heavy duty mini-dies that work in many industry standard presses. Deutsch's applicator dies offer simple adjustments and the flexibility to accept different sized Deutsch contacts and wire gauge.

Automated Tooling for Solid Contacts



Tool P/N	Contact Size	Contact Part Number
HDP-400	4	0460-204-0490
		0462-203-04141
	8	0460-204-08141
		0462-203-08141
	12	0460-204-12**
		0460-203-12**
	16	0460-202-16**
		0462-201-16**
		0460-215-16**
		0462-209-16**
20	0460-202-20**	
	0462-201-20**	

HDP-400 Tooling Accessories



Go-No-Go Gauges

Part Number	Go-No-Go Gauges
GA20N	HDP-400 Size 20
450GA-16N	HDP-400 Size 16
450GA-12N	HDP-400 Size 12
GA8-SPEC	HDP-400 Size 8
450GA-4-SPEC	HDP-400 Size 4



HDP-400 Dies and Locators

Crimp Tool Part Number	Drawing Number Reference
HDP-400	0425-205-0000

■ Automated Tooling for S&F Contacts

Tool P/N	Contact Size	Contact Part Number
DCT12-02-00	12	1060-12-01** 1062-12-01**
DCT12-02-01		1060-12-02** 1062-12-02**
DCT16-02-00	16	1060-16-01** 1062-16-01**
DCT1620-02-00		1060-16-06** 1062-16-06**
DCT20-02-00 DCT1620-02-00	20	1060-20-01** 1062-20-01**



■ DCT Tooling Accessories

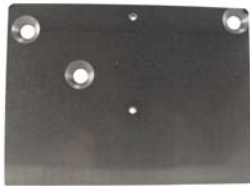

Bolster plate for mounting Deutsch DCT applicators to AMP K press

Part Number	Bolster Plate Accessories
BOLSTER PLATE	Bolster Plate
BOLSTER PLATE BAR	Bolster Plate Bar
BOLSTER PLT CLAMP	Bolster Plate Clamp



Oiler for DCT Series applicators

Part Number	Oiler Accessories
20000082	Oiler Unit
E807	Terminal Lubricant



DCT Applicator Punches and Anvils

Applicator Part Number	Drawing Number Reference
DCT12-02-00	0425-208-0000
DCT12-02-01	0425-041-0000
DCT16-02-00	0425-203-0000
DCT1620-02-00	0425-059-0000
DCT20-02-00	0425-207-0000

Hand Tool Overview

For field service, prototype, and low-volume production, Deutsch offers several easy-to-use hand crimp tools for both solid barrel and stamped & formed contacts. All Deutsch hand crimp tools provide a tight, complete crimp with minimal effort. The HDT-48-00, the most commonly used tool for solid contacts, crimps a wide range of contact sizes with no need to change out dies or locators. It provides a symmetrical four indent crimp, is compact and easy-to-use for field service, yet sturdy and reliable enough for low volume production. Hand crimp tools for stamped & formed contacts are wire gauge specific and simultaneously crimp the insulation and conductor, saving time and effort during field service.

■ Hand Tools for Solid Contacts



HDT-04-08



HDT-48-00



HDT-50-00



HDT-1561

Contact Size	Contact Part Number	Tool Part Number	Crimp Type
4	0460-204-0490 0462-203-04141	HDT-04-08	Two Indent Crimp
8	0460-204-08141 0462-203-08141	HDT-04-08	Two Indent Crimp
12	0460-204-12** 0460-203-12**	HDT-48-00	Four Indent Crimp
		HDT-1561	Two Indent Crimp
		HDT-50-00	One Indent Crimp
16	0460-202-16** 0462-201-16** 0460-215-16** 0462-209-16**	HDT-48-00	Four Indent Crimp
		HDT-1561	Two Indent Crimp
		HDT-50-00	One Indent Crimp
		HDT-48-00	Four Indent Crimp
20	0460-202-20** 0462-201-20**	HDT-1561	Two Indent Crimp
		HDT-50-00	One Indent Crimp
		HDT-48-00	Four Indent Crimp

■ HDT-48-00 Hand Tool Accessories



HDT-48-00 Adjustment Screw and Locking Nut

Part Number	Crimp Tool Replacement Part
0426-209-0000	Adjustment Screw and Locking Nut
M2700-395-10	Locking Nut



Go no go gauges are used to inspect crimp tooling. The G454 gauge is used with the HDT-48-00 hand tool.



Go-No-Go Gauge

Part Number	Description
G454	HDT-48-00 Go-No-Go Gauge

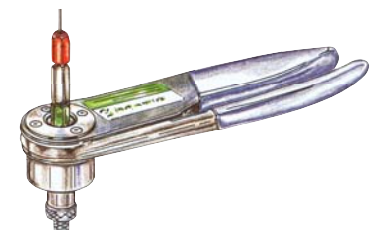



■ Hand Tools for Stamped & Formed Contacts



DTT-12-00



DTT-12-01



DTT-16-00
DTT-16-01
DTT-20-00
DTT-20-02

Contact Size	Contact Part Number	Tool Part Number
12	1060-12-01** 1062-12-01**	DTT-12-00
	1060-12-02** 1062-12-02**	DTT-12-01
16	1060-16-01** 1062-16-01**	DTT-16-00 (14-16 AWG)
	1060-16-06** 1062-16-06**	DTT-16-01 (18 AWG)
20	1060-20-01** 1062-20-01**	DTT-20-00
	1060-20-02** 1062-20-02**	DTT-20-02





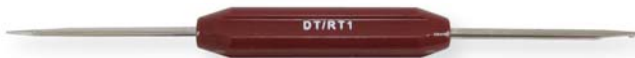





■ DT/RT1

The DT/RT1 is a multi-use tool with a small hook on one end to remove the wedgelock, and a small screwdriver on the other end to push back the locking fingers and release the contact. The DT/RT1 is a helpful tool for the DT, DTM, DTP, DTV, DRB, and STRIKE series of connectors.



■ Removal Tools

Deutsch Industrial removal tools are designed to simplify contact removal and field service repair in all connectors that utilize a round shoulder contact retention system. Removal tools are compact, easy-to-use, and manufactured of heavy duty plastic to remove contacts without damage to the wire, insulation, connector seals, or connector body. The removal tools are required for wire removal in the DTHD, Jiffy Splices, HD10, HDP20, HD30, DRC, AEC, and WT Series.

Removal Tool	Part Number	Contact Size	Wire Gauge Range	Color
	0411-027-0405	Size 4	4 AWG	Black
	114009	Size 4	6 AWG	White
	114008	Size 8	8-10 AWG	Green
	0411-353-0805	Size 8 for HD Box	8-10 AWG	Green Extended
	114010	Size 12	12 AWG	Yellow
	0411-337-1205	Size 12	12-14 AWG Extra Thin Wall (E-Seal)	Orange
	0411-291-1405	Size 14	14-16 AWG	Green
	0411-310-1605	Size 16	16-18 AWG	Light Blue
	0411-336-1605	Size 16	16-18 AWG Extra Thin Wall (E-Seal)	Dark Blue
	0411-240-2005	Size 20	20-24 AWG	Red



A contact removal tool taped or tie wrapped to the harness will make it easily available should repairs be needed.

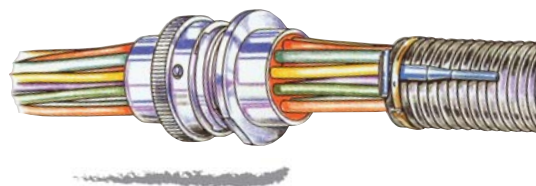







Series Specific Tools

■ Crimp Tools for STRIKE Series

Contact Size	Contact Style	Hand Crimp Tool	Production Crimp Tool
12-20	Solid	HDT-48-00	HDP-400
12	Stamped & Formed	DTT-12-00, DTT-12-01	DCT12-02-00, DCT12-02-01
16	Stamped & Formed	DTT-16-00, DTT-16-01, DTT-16-02	DCT1620-02-00
20	Stamped & Formed	DTT-20-00, DTT-20-02	DCT1620-02-00

■ Assembly/Removal Tools for STRIKE Series

Tool	Part Number	Connector	Description
	SRK-RT-02	Receptacle	TPA removal tool for receptacles Not for use with 18 cavity insert
	SRK-RT-02-G2	Receptacle	TPA removal tool for receptacles For use with 18 cavity insert
	SRK-RT-06	Plug	TPA removal tool for plugs Not for use with 18 cavity insert
	SRK-RT-06-G2	Plug	TPA removal tool for plugs For use with 18 cavity insert
	SRK-MT-02	Receptacle	TPA mounting tool for receptacles
	SRK-RT-01	Plug and Receptacle	Field service removal tool (TPA or contacts) for plugs and receptacles

■ Tools for IMC and Quick Connect Series

The Industrial Micro Connect and Quick Connect Series use special contacts and tools. The contacts are smaller and designed for high pin density. Removal tools along with multiple crimp tools are available and are designed to work with the smaller contacts and tighter pin arrangements. The common contact system and tools are not compatible with the IMC or QC Series.

Tools for Solid Contacts	
Part Number	Adjustable Hand Crimp Tools
MH860	QC/IMC #22 crimp tool, adjustable AWG ranges, requires 86-5
86-5	QC/IMC crimp tool positioner for MH860
AF8-TH163	QC/IMC #20 and #16 crimp tool, adjustable AWG ranges
	Single Gauge Hand Crimp Tools
AMSC22/1	QC/IMC #22 crimp tool, low cost, only crimps 22 AWG wire
AMSC20/1	QC/IMC #20 crimp tool, low cost, only crimps 20 AWG wire
AMSC16/A/1	QC/IMC #16 crimp tool, low cost, only crimps 16 AWG wire
	Insert/Removal Tools
6757-201-2201	Insert/Removal Tool #22
6757-201-2001	Insert/Removal Tool #20
6757-201-1601	Insert/Removal Tool #16



How To Instructions

■ Wire Stripping

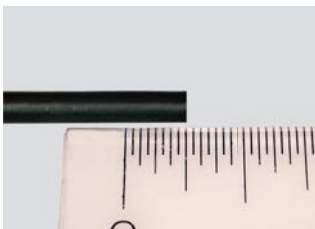

Step 1:

1. Choose the correct AWG for the contact being used.

2. Measure from the end of the wire the recommended strip length according to the contact size.

3. Place the wire into a stripping tool at the recommended strip length. Strip the wire according to stripping tool instructions.



Step 2:

1. After stripping, a small piece of the insulation should come off.

2. Check for any broken strands or for a dent in the wire. If either exist, the wire is damaged and should be cut and stripped again.



Step 3:

Measure the exposed strands to be sure the crimp length is correct.



Leaving the stripped portion of the insulation on the wire until prior to crimping will avoid flayed wire strands.

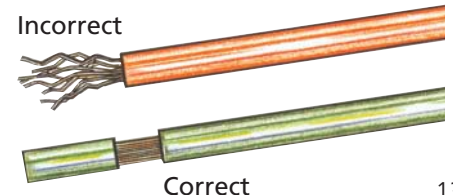



■ Crimping with the HDT-48-00 Hand Tool



Note
Tool must be adjusted for each type/size of contact.



Step 1:

1. Strip insulation from wire.
2. Raise selector knob and rotate until arrow is aligned with wire size to be crimped.
3. Loosen locknut, turn adjusting screw in until it stops.



Step 2:

Insert contact with barrel up. Turn adjusting screw counterclockwise until contact is flush with indenter cover. Tighten locknut.



Step 3:

1. Insert wire into contact. Contact must be centered between indentors. Close handles until crimp cycle is completed.
2. Release handles and remove crimped contact.

■ Crimping with DTT Style Hand Tools (size 16 & 20)



Step 1:

Cycle the hand tool to the open position. Place the contact into the correct die nest.



Step 2:

Partially close the tool until the contact is held in place.

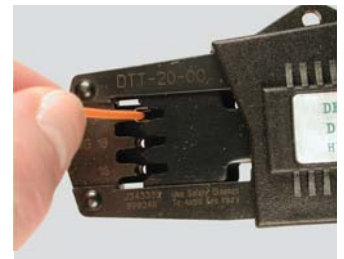

Step 3:

Insert the prestripped wire into the crimp area of the contact.

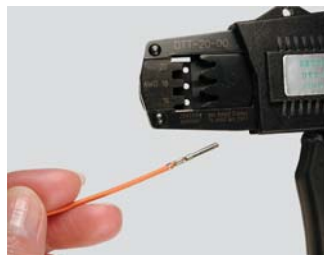

Step 4:

Close the tool until the ratchet releases. The ratchet is released when a loud click is heard and crimp is complete.

■ Crimping with DTT-12-01 Hand Tool



Step 1:
Cycle handles to release ratchet and fully open crimp jaws. Pull out insulation selector and push into proper diameter using the chart below.

Wire Type	Insulation Selector
10 TXL	.150-.170
10 GXL	.160-.180
10 SXL	.170-.205
5.0 mm ²	.160-.180
6.0 mm ²	.170-.205

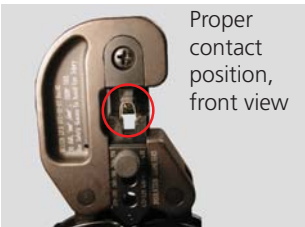

Step 2:
1. Insert contact into locator. Adjust alignment and width of crimp wings if necessary to ensure capture by crimp jaws.
2. Insert stripped wire into the contact. Close crimp tool until full-cycle ratchet control releases.



■ Crimping with DTT-12-00 Hand Tool



Step 1:
Cycle the tool to release ratchet and open tool. Lift the locator gate, and place the contact into the correct die nest. Adjust alignment of crimp wings to ensure capture by crimp jaws.



Step 2:
Partially close the tool until the contact is held in place.



Step 3:
Insert the prestripped wire into the crimp area of the contact.



Step 4:
Close the tool until the ratchet releases. The ratchet is released when a loud click is heard and crimp is complete.