

Data sheet | Item number: 249-111

Test plug adapter; suitable for 255, 256, 257 Series PCB terminal blocks; 1-pole; Pin spacing 5.08 mm / 0.2 in

www.wago.com/249-111

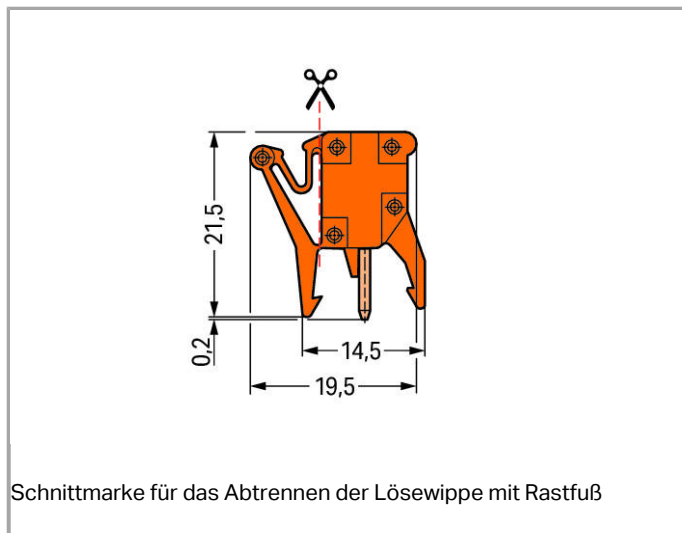

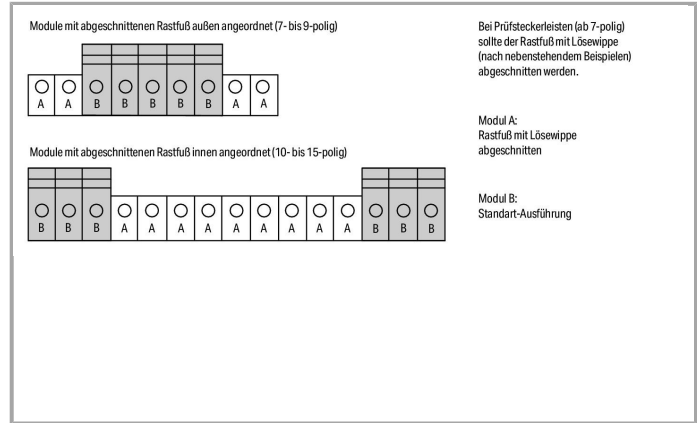
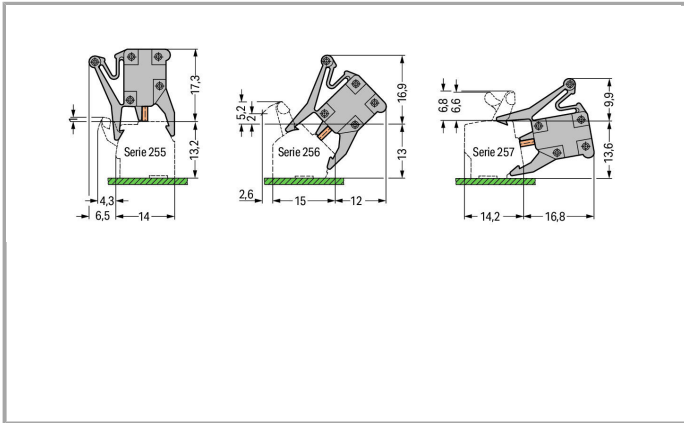

Data

Electrical data

Ratings per IEC/EN 60664-1

Rated voltage (III / 2)	320 V
Rated impulse voltage (III / 2)	4 kV
Rated current	6 A
Legend (ratings)	(III / 2) ≙ Overvoltage category III / Pollution degree 2

Connection data

No. of poles	1
--------------	---

Geometrical Data

Pin spacing	5.08 mm / 0.2 inch
Width	5.08 mm / 0.2 inch
Height	21.5 mm / 0.846 inch
Depth	19.5 mm / 0.768 inch

Material Data

Color	orange
Material group	I
Insulating material	Polyamide 66 (PA 66)
Flammability class per UL94	V0
Weight	1.305 g

Environmental Requirements

Limit temperature range	-60 ... +105 °C
-------------------------	-----------------



Commercial data

Country of origin	CH
GTIN	4045454306823
Customs Tariff No.	85366990990
Product Group	2 (Terminal Block Accessories)

Subject to changes.

WAGO Kontakttechnik GmbH & Co. KG
Hansastr. 27
32423 Minden
Phone: +49571 887-0 | Fax: +49571 887-169
Email: info.de@wago.com | Web: www.wago.com

Do you have any questions about our products?
We are always happy to take your call at +49 (571) 887-44222.