



Product Guide | 2008

NEUTRIK



The Neutrik® Line

<p>XLR Connectors</p>				<p>P. 7 - 30</p>
<p>Plugs & Jacks</p>				<p>P. 31 - 48</p>
<p>Loudspeaker Connectors</p>				<p>P. 49 - 62</p>
<p>Data Connectors</p>				<p>P. 63 - 80</p>
<p>BNC Connectors</p>				<p>P. 81 - 93</p>
<p>Circular Connectors</p>				<p>P. 94 - 108</p>
<p>Accessories</p>				<p>P. 109 - 118</p>
<p>Patch Panels</p>				<p>P. 119 - 133</p>



About Neutrik®

Neutrik® is an international corporation with three decades of know-how and experience in the manufacture of innovative electrical and electronic interconnection products and systems. The company was founded in 1975 as a two man operation with the idea to creating innovative products utilizing the latest in mechanical and electronic know-how and creativity. Today we are the world leader in the design, manufacture and marketing of audio, coaxial, power and circular connectors. Our main priority is to be „one step ahead“, i. e. to understand the future market needs before they become obvious and to accommodate demands before they occur.

From the beginning Neutrik has concentrated on the development of innovative audio connector products. Today Neutrik® leads the way in the professional audio market.

Our audio range includes XLR-connectors, plugs, jacks, speaker connectors, patch bays and fiber optic connection systems. Many patents granted, numerous patents pending and the many license agreements since our beginning in 1975, evidence Neutrik's innovation and creative achievements. No doubt, our customers have the confidence in having high quality products at an unsurpassed cost/performance ratio whenever they come across Neutrik®.

Neutrik's strength lies in it's ability to anticipate the needs of a dynamic marketplace, fast response through innovative designs, features and benefits based on customer feed-back as well application of state-of-the-art production technologies. Neutrik® is committed to excellence in innovation, total quality based on ISO 9001-2000, reliable customer relationship and effective marketing.

Neutrik Group

The Neutrik® Group consists of strategically placed subsidiaries in the United States of America, Great Britain, Switzerland, France, Japan, China and Germany. A network of exclusive distributors in more than 80 countries worldwide provides worldwide sales, technical support and distribution. The corporate headquarters is located in Schaan in the Principality of Liechtenstein, where all operations such as management, R&D, logistics, manufacturing and finance are centered.

Quality

For Neutrik®, quality is the utmost priority. Uncompromising selection of designs, materials and subcontractors as well as manufacturing technologies guarantee the highest level of quality. Neutrik® holds several approvals with manufacturing compliance organizations including UL, cUL, VDE, SEV, CSA. A sophisticated quality system is in place based on ISO 9001-2000 with full traceability of production runs and the supply chain.

Customer Service

It is the Neutrik® philosophy to be customer-orientated and to stay in close contact with our customers all over the world, using an international network of subsidiaries, associated companies and distributors, Neutrik® takes care of consultation, sales and after-sales-service.



Environmental – Compatibility

Neutrik® is committed to the preservation of environmental resources and that our products are developed and manufactured in an environmentally sound and acceptable manner considering health and safety excellence.

We comply with all relevant government laws and directions which relate to environmental protection. We support with all means available to us the preservation of natural resources by economizing the use of materials and by recycling waste. We develop products and processes which are safe, conserve energy and make use of materials which are at a minimum impact on the environment and, where possible, permit recycling.

All production methods are based on environmentally sound handling and the elimination of hazardous material. Some time before the amended EU Directive RoHS (Reduction of

Hazardous Substances) came into force on July 1st 2006, Neutrik® already complied with these requirements laid down therein and stopped using lead in the soldering process at the end of 2004. In addition Neutrik® conforms to the following EU Directives and regulations:

- EU 76/769/EEC
- EU 2000/53/EC
- EU 2002/95/EC (RoHS)
- EU 2002/96/EC (WEEE)
- Sony Technical Standard SS-00259 (Sony Green Partner)

Neutrik® Part Number Guide

NC3FAH1-B-0-D

Packaging:	D	Cable connector: Bulk packed
	D	Chassis connector: Disassembled Push latch
Assembly:	w/o	Latch Lock
	-0	Retention Spring
Retention:	B	Black shell, gold contacts
	BAG	Black shell, silver contacts
Shell:	0	Separate ground contact connected to shell, male only
	1	Pin 1 & Panel & Shell connected, no separate ground contact
	2	Separate ground contact connected to shell & panel, separate Pin 1
	E	Additional ground contacts
	w/o number	No ground / Shell contact (except 4 / 5 pole), female only
Grounding:	H	Horizontal PCB mount
	HL	Lateral left PCB mount
	HR	Lateral right PCB mount
	L	Solder Cups
	V	Verticale PCB mount
	Y	IDC for wires (no ground)
	M3	Mounting holes with M3 thread
	M25	Mounting holes with M2.5 thread
	-	Not applicable
	Series:	A, AA, B, BA, D, DL, DLX, MPR, P, PX, RX, X, XX
Termination:	F	Female
	M	Male
Gender:	3, 4, 5, 6, 7, 8, 12	
Number of Contacts:	3, 4, 5, 6, 7, 8, 12	
Connector Type:	A	Adapter
	AC	PowerCon®
	B	BNC
	C	XLR
	D	Dummy Plug
	E	RJ45
	F	RCA / CINCH
	J (MJ, RJ, SJ)	Jack
	K	Cable Assemblies
	L	Loudspeaker
	M	Modules
	O	Fiber Connector
	P	Plugs
	PP	Patch Panel
	R	Circular Connector
	T	Transformer



XLR Connectors

Content

Page

Cable Connectors:		Receptacles:	
XX Series	9	A Series	17
EMC-XLR Series	9	AA Series	17
RX Series	10	B Series	18
XX-HE	10	BA Series	18
XX-14 Serie	11	A/B Series 5 pole switch	19
XX Crimp Series	11	D Series	19
XX Crystal Series	12	DL Series	20
ConvertCon	12	DLX Series	20
X Series	13	DLX Crimp Series	21
X-HD Series	13	EMC Series	21
XCC Series	14	MPR-HD Series	22
FXS Series	14	Feedthrough	22
FX-SPEC Series	14	P Series	23
Technical Data	15	Combo Series	23
Ordering Information	16	Combo A Series	24
		Accessories	25
		Technical Data	26
		Ordering Information A/AA Series	27
		Ordering Information B/BA Series	28
		Ordering Information D/DL/DLX/DLX Crimp/EMX/P/ MPR-HD /Combo / Combo A Series	29
		Panel Cutouts, Assembly Tools	30

Introduction

The XLR connector series is probably together with the Speakon® series Neutrik's most known product range and has been due to the simple but striking concept one of the most important keys to our great success.

We introduced the first XLR version more than 25 years ago, meanwhile it became the worldwide accepted standard.

XLR connectors are widely used in various applications of the audio and lighting world. Whether microphone connectors, lighting DMX connectors or any other type of sound equipment, the XLR is ubiquitous throughout the entertainment industry.

Key features are:

- Reliable and robust
- Easy to assemble, simple to use
- Excellent cable protection and retention
- Colour coding
- Available in 3 to 7 pole

Our commitment to design and manufacture real world connectors solutions for the entertainment industry has made us the undisputed world leader in XLR connectors.

XLR Cable Connectors



Ergonomic latch design



Neutrik hologram



Inside view



Circumferential ground shield contact

XX Series



NC3FXX



NC6MXX-B

- The next generation of the worldwide accepted standard
- Unique cage type female contact - increases conductivity
- Female contact with "solder stop" for ease soldering
- Male connector without locking "window" - more robust housing, increases durability
- Improved chuck type strain relief - increases retention force and makes assembly easier and faster
- New ground contact - excellent contact integrity between chassis and cable connector
- Customized branding using translucent ring
- Sleek and ergonomic design - valuable and handy
- Unique hologram – guarantees genuineness and protects against counterfeits
- Internal thread on shell is well protected against any damage.

NC*FXX



NC*MXX



* ... 3 - 7 contacts

EMC-XLR Series



NC3FXX-EMC



NC3MXX-EMC

- 3-pole male / female XLR cable connector with integrated capacitive shield to shell connection to avoid RF-interference and LF-noise
- 360° shield contact on female connector ensures best possible shielding and chassis contact
- Patent pending

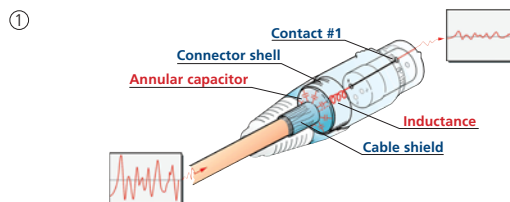

- ① Design guarantees a continuous RF-shield connection but avoids ground loops (no LF-shield connection)
- ② Circular capacitor enables low-inductive shield connection to connector housing
- ③ Cable shield - PIN 1 connection includes EMI suppression bead (blocks high frequencies)



XLR Cable Connectors



Right angle male connector



High temperatur resistant insulator



Velour chromium housing

RX Series



NC3FRX-BAG



Outlet position

- Right angle version of the XX Series - only 20 mm wide
- Extra slim right-angle connector
- Neutrik chuck type strain relief
- 5 selectable cable outlet positions

XX-HE Series



NC3FXX-HE



NC3MXX-HE

- Exclusive version of standard XX Series
- Valuable velour chromium plating
- Extra high temperature resistant insulator material
- Machined female contacts
- Flammability UL 94V-0

NC*FRX



NC*MRX



* ... 3 - 7 contacts

NC3FXX-HE



NC3MXX-HE





Large cable outlet

XX-14 Series

NEW



NC3FXX-14

NC3MXX-14-BAG

- 3 pin XX Series with extra large boot
- Accommodates cable O.D. up to 9.6 mm
- Available in bulk pack only

XX Crimp Series

NEW



NC3FXX-BAG-HA

NC3MXX-HA

- 3 pin XX Series with crimp contacts
- Accommodates wire size AWG 26 - 23 or 0.14 – 0.25 mm²
- Utilize standard B-type crimp tool (acc. IEC 60352-2)
- Absolute leadfree and solderless connection:
 - RoHs compliance
 - health and eco-friendly
- Fast and easy assembly
- Gas-tight connection offers a constant contact resistance
- Ideal solution for field and on-site termination

NC3FXX-14



NC3MXX-14



NC3FXX-HA



NC3MXX-HA



XLR Cable Connectors



Crystal stones



ConvertCon male - female

XX Crystal XLR

NEW



NC3FXX-B-CRYSTAL

NC3MXX-B-CRYSTAL

- XLR XX Series made with CRYSTALLIZED™ – Swarovski Elements
- Fancy, noble, valuable, attractive package - an eye-catcher

ConvertCon

NEW



NC3FM-C-B

NC3FM-C

- World's first unisex XLR
- Male and female cable connector in one housing
- Easy selectable gender – converted by sliding housing back and forth
- Substitute adapters, ideal as an emergency kit



Convert male - female and vice versa

NC3FXX-B-CRYSTAL



NC3MXX-B-CRYSTAL



NC3FM-C: Position Female

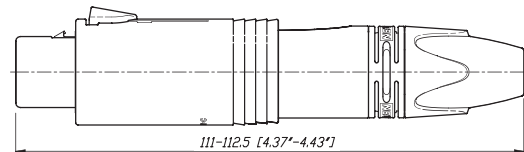

NC3FM-C: Position Male



XLR Cable Connectors

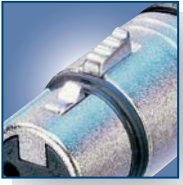

Female locking



Male metal locking window



Rubber sealing protection



Metal bushing

X Series



NC3FX



NC3MX + BSX-5

- The worldwide accepted XLR connector standard
- Rugged diecast shell
- Compact design (shortest available XLR cable connector)
- Time saving assembly – 4 parts only, no screws
- Neutrik unique chuck type strain relief
- Gold or silver plated contacts
-  UL Recognized components
- Available in 3 - 7 pin configuration

X-HD Series



NC5FX-HD



NC4MX-HD

- "Heavy duty" cable connectors for outdoor use
- All metal design, male stainless steel
- NC*FX-HD mates with NC*MPR-HD chassis connector and NC*MX-HD
- Dust and water protected according IP 65 in mated condition
- Available in 3 - 5 pin configuration
- Metal bushing including O-ring

NC*FX



NC*MX



* ... 3 - 7 contacts

NC*FX-HD



NC*MX-HD



* ... 3 - 5 contacts

XLR Cable Connectors



Coding ring



Switch activating ring



Locking ring

XCC Series



NC3FXCC

- 3 pole cable connector with a circumferential shield contact for best EMI protection
- Featuring a coaxial ground spring and coaxial hex crimp ferrule at the cable entrance for proper and reliable transition of the cable shield to the shell
- Zebra coding ring to indicate digital AES signals included

FXS Series



NC3FXS

- FX connector with noiseless ON-OFF switch short-circuiting contacts 2 + 3
- For use on a microphone without switch

FX-SPEC Series



NC3FX-SPEC

- Solid female cable connector with locking ring for highest security of connection
- Uninterrupted EMI protection
- Protects against accidental disconnects
- Thief-proof, grub screw secure connector onto microphone or gooseneck
- Eliminates movement and noise

NC3FXCC



NC3FXS

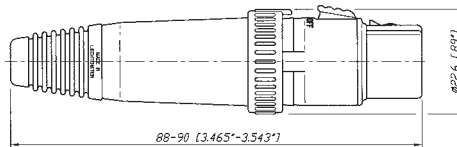

NC3FX-SPEC



NC3MXCC



Technical Data

Specification		XX & XX-14 & CRYSTAL	EMC Series	X Series	XCC Series	X-HD Series	FXS Series	XX-HE Series	FX-SPEC Series	RX Series	XX Crimp Series	Convert-Con Series
Electrical												
Number of contacts		3 - 7 ¹⁾	3	3 - 7	3	3 - 5	3	3	3	3 - 7	3	3
Contact resistance	≤ 3 mΩ	●	●	●	●	●	●	●	●	●	●	●
Insulation resistance	- initial:	●	●	●	●	●	●	●	●	●	●	●
	- after damp heat test:	●	●	●	●	●	●	●	●	●	●	●
Dielectric strength	1500 V dc	●	●	●	●	●	●	●	●	●	●	●
Cable shield-shell connection	choosable	●	-	●	-	●	-	●	●	●	●	●
	determined	-	capacitive	-	crimp	-	-	-	-	-	-	-
Shielding effectiveness	> 55 dB @ 1.3 GHz	-	●	-	●	-	-	-	-	-	-	-
Lossy ferrite bead on PIN 1		-	●	-	-	-	-	-	-	-	-	-
Rated current per contact @ 35°C												
	3 pole: 16 A	●	5 A	●	●	●	●	●	●	●	1 A	●
	4 pole: 10 A	●	-	●	-	●	-	-	-	●	-	-
	5, 6 pole: 7.5 A	●	-	●	-	●	-	-	-	●	-	-
	7 pole: 5 A	●	-	●	-	-	-	-	-	●	-	-
Capacitance between contacts												
	3 pole: ≤ 4 pF	●	●	●	●	●	●	●	●	●	●	●
	4, 5, 6 pole: ≤ 7 pF	●	-	●	-	●	-	-	-	●	-	-
	7 pole: ≤ 9 pF	●	-	●	-	-	-	-	-	●	-	-
Rated Voltage	50 V ac	●	●	●	●	●	●	●	●	●	●	●
Mechanical												
Lifetime > 1'000 cycles		●	●	●	●	●	●	●	●	●	●	●
Insertion / withdrawal force ≤ 20 N		●	●	●	●	●	●	●	●	●	●	●
Cable O.D. range	3.5 - 8.0 mm	● ²⁾	●	●	5.4 - 6.2 mm	●	●	●	●	●	●	●
Max. wire size	3 pole: 2.5 mm ² / AWG 14	●	AWG 20	●	●	●	●	●	●	●	-	●
	4 pole: 1.5 mm ² / AWG 16	●	-	●	-	●	-	-	●	●	-	-
	5, 6, 7 pole: 1.0 mm ² / AWG 18	●	-	●	-	●	-	-	-	●	-	-
Crimp tool:	6.5 mm Hex die (size "E" acc. to IEC 60803)	-	-	-	●	-	-	-	-	-	B-crimp	-
Crimp XX:	0.14 - 0.25 mm ² / AWG 26 - 23	-	-	-	-	-	-	-	-	-	●	-
Material												
Shell	Zinc diecast (ZnAl4Cu1)	●	●	●	●	-	●	●	●	●	●	●
	(gal Ni or black Cr)	●	gal Ni	-	●	-	●	velour Cr	●	●	●	●
	Stainless steel	-	-	-	-	●	-	-	-	-	-	-
Insert	Polyamide PA 6.6 30% GR	●	●	●	●	●	●	●	●	●	●	●
Contacts	- female 3 pole: Bronze (CuSn8)	●	●	●	●	●	●	●	●	●	●	●
	- female 4 - 7 pole & male: Brass (CuZn39Pb3)	●	●	●	●	●	-	●	-	●	-	-
Contact surface	Silver gal 2 μm Ag	●	Au	●	●	Au	●	●	Au	●	●	●
	or Gold gal 0.2 μm Au hard alloy over 2 μm Ni	-	-	-	-	-	-	-	-	-	-	-
Latch lock	St3K32 (latch) / Ck 67 (spring)	-	-	●	●	●	●	-	●	-	-	-
	Zinc diecast (ZnAl4Cu1)	●	●	-	-	-	-	●	-	●	●	●
Strain-relief clamp	POM	●	●	●	●	●	●	●	●	●	●	●
Bushing	PA / PU	●	●	●	●	PU	PU	●	●	●	●	●
Circumferential ground spring	Bronze (CuSn6), Ni plated	-	●	-	●	-	-	-	-	-	-	-
Crimp ferrule	Brass (CuZn39Pb3), Ni plated	-	-	-	●	-	-	-	-	-	-	-
Coding ring	Polyamide PA 6 15% GR	-	-	-	●	-	-	-	-	-	-	-
Sealing jacket	EPDM	-	-	-	-	●	-	-	-	-	-	-
Securing ring	Brass (CuZn39Pb3)	-	-	-	-	-	-	-	●	-	-	-
Environmental												
Operating temperature	-30°C to +80°C	●	●	●	●	●	●	●	●	●	●	●
Flammability	UL 94 HB	●	●	●	●	●	●	V-0	●	●	●	●
Protection class	IP 40	●	●	●	●	IP 65	●	●	●	●	●	●
Solderability complies with IEC	68-2-20	●	●	●	●	●	●	●	●	●	●	●
Manufacturing Standard IEC	61076-2-103	●	●	●	●	●	●	●	●	●	●	●

XX-14, CRYSTAL: ¹⁾ ... 3 pole ²⁾ ... Cable O.D. max. 9.6mm

Ordering Information for Cable Connectors

Female	Male	Shell	Contact - plating	3 pole	4 pole	5 pole	6 pole	7 pole
XX Series								
NC*FXX	NC*MXX	Nickel	Silver	●	●	●	●	●
NC*FXX-B	NC*MXX-B	Black Cr	Gold	●	●	●	●	●
NC*FXX-BAG	NC*MXX-BAG	Black Cr	Silver	●	●	●	●	●
NC3FXX-**-D ¹	NC3MXX-**-D ¹	Nickel / Black Cr	Silver / Gold	●	-	-	-	-
NC6FSXX ²	NC6MSXX ²	Nickel	Silver	-	-	-	●	-
NC6FSXX-B ²	NC6MSXX-B ²	Black Cr	Gold	-	-	-	●	-
NC6FSXX-BAG ²	NC6MSXX-BAG ²	Black Cr	Silver	-	-	-	●	-
XX-EMC Series								
NC3FXX-EMC	NC3MXX-EMC	Nickel	Gold	●	-	-	-	-
NC3FXX-EMC-B	-	Black Cr	Gold	●	-	-	-	-
RX Series								
NC*FRX	NC*MRX	Nickel	Silver	●	●	●	●	●
NC*FRX-B	NC*MRX-B	Black Cr	Gold	●	●	●	●	●
NC*FRX-BAG	NC*MRX-BAG	Black Cr	Silver	●	●	●	●	●
XX-HE Series								
NC3FXX-HE	NC3MXX-HE	Velour Chromium	Gold	●	-	-	-	-
XX-14 Series								
NC3FXX-14-D	NC3MXX-14-D	Nickel	Silver	●	-	-	-	-
NC3FXX-14-B-D	NC3MXX-14-B-D	Black Cr	Gold	●	-	-	-	-
NC3FXX-14-BAG-D	NC3MXX-14-BAG-D	Black Cr	Silver	●	-	-	-	-
XX Crimp Series								
NC3FXX-HA	NC3MXX-HA	Nickel	Gold	●	-	-	-	-
NC3FXX-HA-BAG	NC3MXX-HA-BAG	Black Cr	Silver	●	-	-	-	-
ConvertCon Series								
	NC3FM-C	Nickel	Gold	●	-	-	-	-
	NC3FM-C-B	Black Cr	Gold	●	-	-	-	-
Crystal XLR								
NC3FXX-B-CRYSTAL	NC3MXX-B-CRYSTAL	Black Cr	Gold	●	-	-	-	-
X Series								
NC*FX	NC*MX	Nickel	Silver	●	●	●	●	●
NC*FX-B	NC*MX-B	Black Cr	Gold	●	●	●	●	●
NC*FX-BAG	NC*MX-BAG	Black Cr	Silver	●	●	●	●	●
NC3FX-**-D ¹	NC3MX-**-D ¹	Nickel / Black Cr	Silver / Gold	●	-	-	-	-
NC6FSX ²	NC6MSX ²	Nickel	Silver	-	-	-	●	-
NC6FSX-B ²	NC6MSX-B ²	Black Cr	Gold	-	-	-	●	-
NC6FSX-BAG ²	NC6MSX-BAG ²	Black Cr	Silver	-	-	-	●	-
X-HD Series								
NC*FX-HD	NC*MX-HD	Nickel	Gold	●	●	●	-	-
NC3FX-HD-B	NC3MX-HD-B	Metal Black	Gold	●	-	-	-	-
XCC Series								
NC3FXCC	NC3MXCC	Nickel	Gold	●	-	-	-	-
FXS Series								
NC3FXS	-	Nickel	Gold	●	-	-	-	-
NC3FXS-B	-	Black Cr	Gold	●	-	-	-	-
FX-SPEC Series								
NC3FX-SPEC	-	Black Cr	Gold	●	-	-	-	-

Detailed information on page 21 and 26.

* Number of Contacts

** Nickel or Black

-D¹ Bulk packed, to be ordered in multiples of 100 pcs.

² Switchcraft Equivalent



XLR Chassis Connectors



Colored coding ring



Lateral right PCB mount



Locking release tab



Ground contact tab

A Series



NC3FAH-0



NC3MAV

- Smallest XLR receptacles, highest packing density
- Plastic housing, steel retention lug
- Various grounding options
- "Tulip" type female contact design with high contact pressure
- Selective gold plated contact and PCB termination area for best conductivity and solderability
- Plastic housing flammability UL 94V-0

AA Series



NC3FAAV2



NC3MAAH-1

- Front panel cutout and PCB layout 100% compatible to the A Series
- Most cost-effective series
- "Tulip" type female contact design with high contact pressure
- Selective gold plated contact and PCB termination area for best conductivity and solderability
- Plastic housing flammability UL 94 HB

NC5FAV



NC5FAH



NC3MAV-0

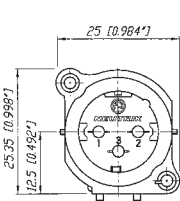

NC5MAH

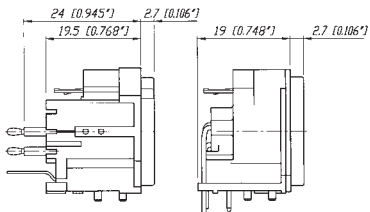

NC3FAAH

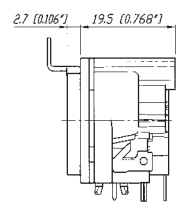

NC3FAAV-0

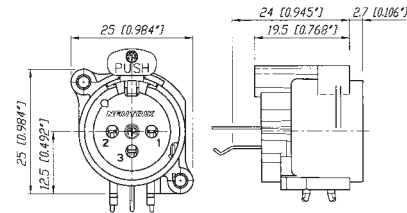

Grounding Options (A / AA / B / BA Series):

Female:

- 1 ... Pin 1 & Panel & Shell connected, no separate ground contact
 - 2 ... Separate ground contact connected to shell & panel, separate Pin 1
- w/o number: No ground / Shell contact (except 4 / 5 pole)

Male:

- w/o number: Separate ground contact connected to shell & panel, separate Pin 1
- 0 ... Separate ground contact, connected to shell, separate Pin 1
 - 1 ... Pin 1 & Panel & Shell connected, no separate ground contact

XLR Chassis Connectors



Circumferential metal ring



Front panel grounding



Tear drop contact design

B Series



NC3FBV



NC3MBV

- Same as A Series with exception of a metal mounting flange enabling continuous circumferential ground contact to chassis for best EMC and RF protection
- Fastening with B-screw

BA Series



NC3FBAV2



NC3MBAH

- More economical version of B Series with modified metal flange
- Fastening with A-screw
- 3, 4 and 5 pole version

NC3FBY



NC3FBH1



NC3FBAV



NC3FBAH

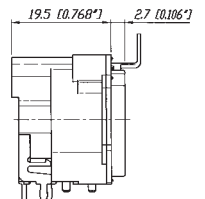

NC3MBH



NC3MBV

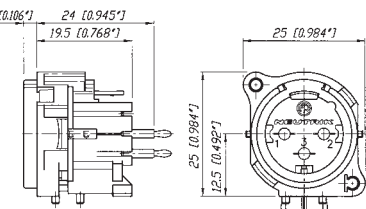

NC3MBAV



NC3MBAH

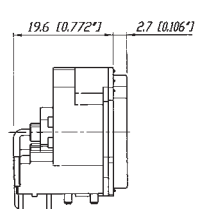



Incorporated switch



Insert removable



A/B Series 5-pole switch



NC5FAV-SW



NC5MAV-SW

- A and B Series 5 pole connector with additional switch
- Normally open, normally closed (NO - NC) contact
- Switch activated by mating XLR cable connector
- Available in 5 pole, 3 or 4 pole on request

Inserting (Schematic):



NC5FAV-SW



NC5MBV-SW



D Series



NC3FD-H



NC3MD-V

- "D" Shape metal shell
- Optimal RF protection using 3 shield contacts
- Horizontal and vertical PCB mount with separate ground contact
- Mounting holes with M3 threads available
- 2 piece connector, insert is removable from shell
- Front locked / unlocked insert
- Special version with screw termination

NC3FD-V / NC3FD-H

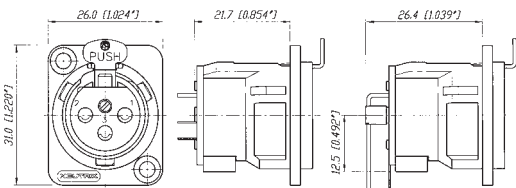

NC3MD-V / NC3MD-H

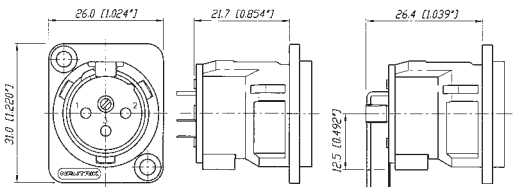



Locking release tab



Horizontal PCB mount



Ground shielding

DL Series



NC3FD-L-1



NC4MDM3-H

- Unified "D" metal shell
- Solder cups on 3 - 7 pole version
- Additional PCB mount on 4 and 5 pole
- Front and rear mountable
- High End "-HE" version available with machined female contacts, temperature resistant insulator and valuable velour chromium plating

NC3FD-L-1

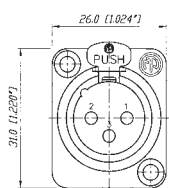

NC*FDM3-H

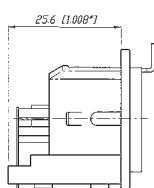
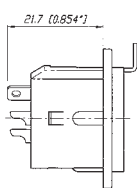

NC3MD-L-1

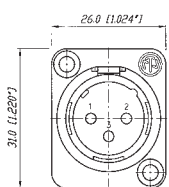

NC*MDM3-H

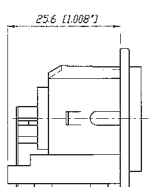
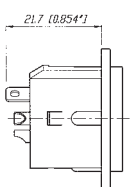

* ... 3 - 5 contacts

DLX Series



NC3FD-LX-HE



NC5MD-LX

- Next generation of the popular DL Series with greater functionality
- All metal housing works in combination with a new duplex ground contact yielding the best RF protection and ground conductivity in a chassis mount XLR
- Male connector's retention bar replaces plastic design with all metal version
- Unique cage type female contacts on 3 pole version for increased conductivity
- Machined male and female contacts on four to seven pin versions
- D-style housing provides installation compatibility with industry standard D mounting dimensions

NC3FD-LX



NC*MD-LX



* ... 3 - 7 contacts





Crimp type contact



Circumferential ground spring

DLX Crimp Series

EMC Series

NEW



NC3FD-LX-HA



NC3MD-LX-BAG-HA



NC3FDX-EMC-SPEC

- 3 pole DLX Series with crimp contacts
- Accommodates wire size AWG 26 - 23 or 0.14 – 0.25 mm²
- Utilize standard B-type crimp tool (acc. IEC 60352-2)
- Absolute leadfree and solderless connection:
 - RoHs compliance
 - health and eco-friendly
- Fast and easy assembly
- Gas-tight connection offers a constant contact resistance
- Ideal solution for field and on-site termination

- 3 pole female XLR chassis connector with integrated capacitive shield to shell connection to avoid RF-interference and LF-noise
- 360° shield contact on female connector ensures best possible shielding and chassis contact
- D flange chassis for panel mount applications
- Includes the locking nut of the NC3FX-SPEC for secure fastening of a gooseneck for instance
- Special flange for large openings available
- Patent pending

Detailed information of RF-shielding see page 9 - EMC cable-connector.

NC3FD-LX-HA



NC3MD-LX-HA



NC3FDX-EMC-SPEC





Sealing Gasket



Through hole fastening

MPR-HD Series



NC3MPR-HD



NC5MPR-HD

- IP 65 - in combination with NC*FX-HD cable connectors
- Perfect for outdoor applications
- Sealing gasket for water tight panel mount
- Gold plated contacts



NC5MPR-HD

NC5FX-HD

NC3MPR-HD



* ... 3 - 5 contacts

P Series



NC3FP-1



NC6MP-B

- Smallest available traditional style hard wiring receptacles with large solder cups
- Compatible with Switchcraft DxM, DxM; Cannon XLRx31, XLRx32
- 6 pole version available with Switchcraft contact arrangement (NC6FSP-1, NC6MSP)

NC3FP-1



NC3MP





Front end design



Solder termination

Combo Series



NCJ9FI-V



NCJ10FI-S

- Combined XLR receptacle and 1/4" phone jack
- Attractive "front end" design
- Saves rack space by combining 2 connectors in one housing
- Horizontal or vertical PCB mounting or hard wire soldering
- Fully normalised
- Stereo or mono version
- Very low conductor capacitance, therefore suitable for digital audio
- Fastening: Self-tapping Plastite® screws with thread 2.9 x 1.06 and tri-rondular configuration (A screw)
- Front dimension: 30 x 27 mm



XLR receptacle or
1/4" phone jack

NCJ10FI-H

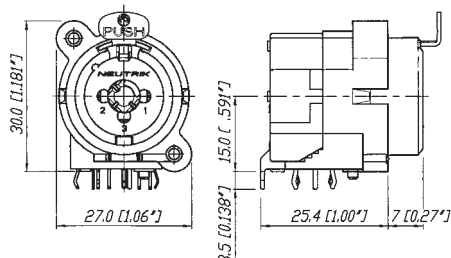



Horizontal PCB mount



Vertical PCB mount



Hologram

Combo A Series

NEW



NCJ6FA-V



NCJ6FA-H-0



NCJ6FA-V-0

- Combined 3 pole XLR receptacle and 1/4" phone jack for balanced mic and line or instrument inputs in one XLR housing
- Dramatic space saving - 15% over the predecessor Combo
- Two connectors in one housing - substantial cost, material and labour saving
- Horizontal and vertical PCB mount available
- 3 pole female XLR combined with stereo TRS jack
- Very low conductor capacitance - ideal for digital audio
- Front panel cut-out compatible with Neutrik XLR A Series
- Branded with unique hologram - guarantees genuine and authentic Neutrik product

NCJ6FA-V

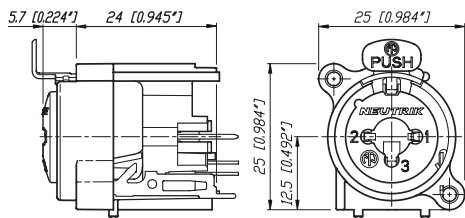

NCJ6FA-H

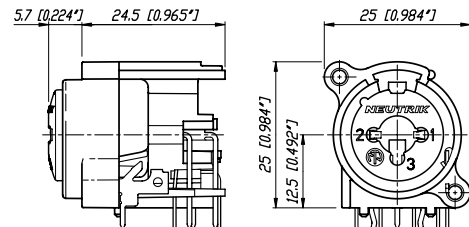

Colour Coded Accessories

Part No.	Description	Black	Brown	Red	Orange	Yellow	Green	Blue	Violet	Grey	White
		0	1	2	3	4	5	6	7	8	9
XLR Cable Connectors											
BSX-*	Coloured bushing for X Series										
BXX-*	Coloured bushing for XX Series										
XCR-*	Coloured coding ring for X Series										
XXR-*	Coloured coding ring for XX Series										
XLR Chassis Connectors											
ACRF-*	Coloured ring for female 4 + 5 pole A Series and 3 pole BA Series										
ACRM-*	Coloured ring for male 4 + 5 pole A Series and 3 pole BA Series										
DSS-*	Lettering plate for D Series										

Accessories

XLR Cable Connectors



BXX-CR	Bushing with translucent coding ring
XCCR	Coding ring for X Series digital signals
XXCR	Translucent coding ring for XX Series for XX Series

XLR Chassis Connectors



A-Screw-1-8	Plastite® screw 2.9 x 8
B-Screw-1-8	TAPTITE® screw 2.5 x 8
DBA	Dummy-plate for D Series panel cut outs
FDR1	Round panel mounting flange for NC3FDX-EMC-SPEC
HA-3FXX	Set of 50 female spare contacts for crimp XLR
HA-3MXX	Set of 50 male spare contacts for crimp XLR
MFD	M3 mounting frame for D-size chassis
NDF	Dummy plug for female XLR chassis connector
NDM	Dummy plug for male XLR chassis connectors
SC*	Rubber sealing cap for female and male XLR receptacles



SCD*	Rubber sealing cover for female and male D Series
SCDR	Rear end protection cover for D-size chassis connectors
SCDX	Hinged cover seals D-size chassis connectors, IP42 rated
SFAV	Rubber frame for A / B Series to mount between front plate and rear vertical print

Specification

A AA B BA D DL/DLX DLX MPR-HD P Combo A
Series Series Series Series Series Series Crimp Series Series Series Combo

Electrical

Number of contacts		3 - 5	3	3 - 5	3	3	3 - 7	3	3 - 5	3 - 7 (6**)	5 - 10	3 / 3
Contact resistance	≤ 6 mΩ	●	●	●	●	●	●	●	●	●	≤ 10 mΩ	≤ 10 mΩ
Insulation resistance	- initial:	●	●	●	●	●	●	●	●	●	●	●
	- after damp heat test:	●	●	●	●	●	●	●	●	●	> 500 MΩ	●
Dielectric strength	1500 V dc	●	●	●	●	●	●	●	●	●	●	●
Rated voltage	50 V ac	●	●	●	●	●	●	●	●	●	●	●
Rated current per contact	3 pole: 6 A	●	●	●	●	●	16 A	1 A	16 A	16 A	-	3 A
	4 pole: 6 A	●	-	●	-	-	10 A	-	10 A	10 A	-	-
	5, 6 pole: 3 A	●	-	●	-	-	7.5 A	-	7.5 A	7.5 A	-	-
	7 pole: 5 A	-	-	-	-	-	●	-	-	●	-	-
	Combo XLR + Jack contact	7.5 A	-	-	-	-	-	-	-	-	-	●
Capacitance between contacts	3 pole: ≤ 7 pF	●	●	●	●	-	≤ 4 pF	≤ 4 pF	≤ 4 pF	≤ 4 pF	≤ 2 pF	≤ 2 pF
	4, 5, 6 pole: ≤ 7 pF	●	-	●	-	-	●	-	●	●	-	-
	7 pole: ≤ 9 pF	-	-	-	-	-	●	-	-	●	-	-
			-	-	-	-	-	-	-	-	-	-

Mechanical

Lifetime	> 1'000 mating cycles	●	●	●	●	●	●	●	●	●	●	●
Insertion / withdrawal force	≤ 20 N	●	●	●	●	●	●	●	●	●	●	25 N
Retention method	- standard: latch lock	●	●	●	●	●	●	●	●	●	● (XLR)	● (XLR)
	- "0" Version: ≥ 20 N separating force	●	●	●	●	●	●	●	●	●	●	25 N

Material

Insert	Polyamide	PA 6.6 30% GR	●	●	●	●	●	●	●	●	●	●
Shell	Zinc diecast	ZnAl4Cu1	-	-	-	-	●	●	●	●	-	-
		(gal Ni or black Cr plated)	-	-	-	-	●	●	●	Ni plated	●	-
Ring	Zinc diecast	ZnAl4Cu1	-	-	●	●	-	-	-	-	-	-
Contacts	- female	3 pole: Bronze CuSn6	●	●	●	●	●	●	●	-	●	●
		4 - 5 pole: Bronze CuSn6	●	-	●	-	-	-	-	-	-	-
		4 - 7 pole: Brass CuZn39Pb3	-	-	-	-	-	●	-	-	●	-
	- male:	Brass CuZn35Pb2	●	●	●	●	●	●	●	●	-	-
Contact surface	gal 0.2 μm AuCo over 2 μm NiP15 (Tribor®)		●	●	●	●	-	-	-	-	●	●
	gal 2 μm Ag or gal 0.2 μm Au hard alloy over 2 μm Ni		-	-	-	-	●	●	●	Au	●	-
Latch lock & spring		Ck 67 steel, treated	●	●	●	●	●	●	●	-	●	●

Environmental

Operating temperature	-30°C to +80°C	●	●	●	●	●	●	●	●	●	●	●
Protection class	IP 40	●	●	●	●	●	●	●	IP 65	●	●	●
Flammability	UL 94 HB	●	●	●	-	●	●	●	●	●	●	●
	UL 94 V-0	3 pole	-	3 pole	●	-	-	-	-	-	-	-
Solderability complies with IEC	68-2-20	●	●	●	●	●	●	●	●	●	●	●
Mounting screw		A	A	1)	A	-	-	-	-	-	A	A
Colour coding		ACR-*	-	-	ACR-*	DSS	DSS	DSS	-	-	-	-

(4 + 5 pole only)

1) B Series 3 pole connectors > B-screw, 4 & 5 pole versions > A-screw

** P Series male 3 - 6 pole



Ordering Information for Receptacles

Female	Male	Shell	Contact	3 pole	4 pole	5 pole	Female	Male	Shell	Contact	3 pole	
A Series							AA Series					
NC*FAH-D		Black Plastic	Gold	-	● ^⓪	● ^⓪	NC3FAAH	NC3MAAH	Black Plastic	Gold	●	
	NC*MAH	Black Plastic	Gold	●	●	●	NC3FAAH-0		Black Plastic	Gold	●	
NC*FAH-0		Black Plastic	Gold	●	● ^⓪	● ^⓪	NC3FAAH1	NC3MAAH-1	Black Plastic	Gold	●	
	NC3MAH-0	Black Plastic	Gold	●	-	-	NC3FAAH1-0		Black Plastic	Gold	●	
NC3FAHL-0		Black Plastic	Gold	●	-	-		NC3MAAH-0	Black Plastic	Gold	●	
NC3FAHR-0		Black Plastic	Gold	●	-	-	NC3FAAH2		Black Plastic	Gold	●	
NC3FAH1-D	NC3MAH-1	Black Plastic	Gold	●	-	-	NC3AAH2-0		Black Plastic	Gold	●	
NC3FAH1-0		Black Plastic	Gold	●	-	-	NC3FAAV	NC3MAAV	Black Plastic	Gold	●	
NC3FAHL1-D		Black Plastic	Gold	●	-	-	NC3FAAV-0		Black Plastic	Gold	●	
	NC3MAHL	Black Plastic	Gold	●	-	-	NC3FAAV1	NC3MAAV-1	Black Plastic	Gold	●	
NC3FAHL1-0		Black Plastic	Gold	●	-	-	NC3FAAV1-0		Black Plastic	Gold	●	
NC3FAHR1-D		Black Plastic	Gold	●	-	-		NC3MAAV-0	Black Plastic	Gold	●	
	NC3MAHR	Black Plastic	Gold	●	-	-	NC3FAAV2		Black Plastic	Gold	●	
NC3FAHR1-0		Black Plastic	Gold	●	-	-	NC3FAAV2-0		Black Plastic	Gold	●	
NC3FAH2-D		Black Plastic	Gold	●	-	-						
NC3FAH2-0		Black Plastic	Gold	●	-	-						
NC3FAHR2-D		Black Plastic	Gold	●	-	-						
NC3FAHR2-0		Black Plastic	Gold	●	-	-						
NC*FAV-D		Black Plastic	Gold	-	● ^⓪	● ^⓪						
	NC*MAV	Black Plastic	Gold	●	●	●						
NC*FAV-0		Black Plastic	Gold	●	● ^⓪	● ^⓪						
	NC3MAV-0	Black Plastic	Gold	●	-	-						
NC3FAV1-D	NC3MAV-1	Black Plastic	Gold	●	-	-						
NC3FAV1-0		Black Plastic	Gold	●	-	-						
NC3FAV2-D		Black Plastic	Gold	●	-	-						
NC3FAV2-0		Black Plastic	Gold	●	-	-						
NC3FAY-D	NC3MAY	Black Plastic	Gold	●	-	-						
NC3FAY-0		Black Plastic	Gold	●	-	-						
NC5FAV-SW-D	NC5MAV-SW	Black Plastic	Gold	-	-	●						

A Series - D version come with disassembled Push latch, version with assembled latch omit -D.

AA Series comes with Push Latch assembled.

A / AA Series rear mount only, all PCB mount except Y version = IDC

⓪... Grounding Option "2"

0... Retention Spring

Grounding Options

A / AA Series and B / BA Series

Female

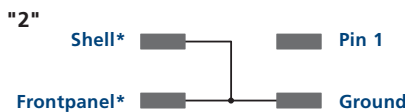
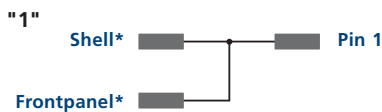

Male

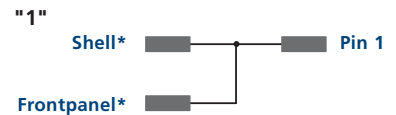
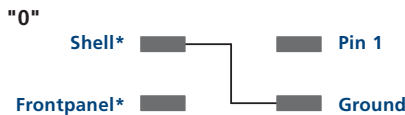
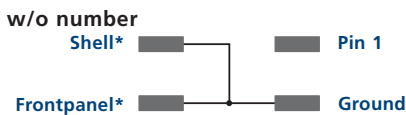

Shell* ... Contact to shell of mating connector

Frontpanel* ... Connection to frontpanel by fastening screw

Ordering Information for Receptacles

Female	Male	Flange	Contact	3 pole	Female	Male	Flange	Contact	3 pole	4 pole	5 pole
B Series					BA Series						
	NC*MBH	Metal	Gold	●	NC3FBAH1-D		Metal	Gold	●	-	-
	NC*MBH-B	Black Metal	Gold	●		NC3MBAH	Metal	Gold	●	-	-
	NC*MBH-M25	Black Metal	Gold	●	NC3FBAH1-0		Metal	Gold	●	-	-
	NC*MBH-B-M25	Black Metal	Gold	●		NC3MBAH-0	Metal	Gold	●	-	-
NC3FBH1-D		Metal	Gold	●	NC3FBAH2-D		Metal	Gold	●	-	-
NC3FBH1-B-D		Black Metal	Gold	●		NC3MBAH-1	Metal	Gold	●	-	-
NC3FBH1-M25		Metal	Gold	●	NC3FBAH2-0		Metal	Gold	●	-	-
NC3FBHL1-D		Metal	Gold	●	NC3FBAV1-D		Metal	Gold	●	-	-
	NC3MBHL	Metal	Gold	●		NC3MBAV	Metal	Gold	●	-	-
NC3FBHR1-D		Metal	Gold	●		NC3MBAV-0	Metal	Gold	●	-	-
NC3FBH2-D		Metal	Gold	●	NC3FBAV2-D		Metal	Gold	●	-	-
NC3FBH2-B-D		Black Metal	Gold	●		NC3MBAV-1	Metal	Gold	●	-	-
NC3FBHR2-D		Metal	Gold	●	NC3FBAV2-0		Metal	Gold	●	-	-
	NC3MBHR	Metal	Gold	●							
	NC*MBV	Metal	Gold	●	NC*FBH-D		Metal	Gold	-	●	●
	NC*MBV-B	Black Metal	Gold	●		NC*MBH	Metal	Gold	-	●	●
	NC*MBV-M25	Metal	Gold	●	NC*FBH-B-D		Black Metal	Gold	-	●	●
	NC*MBV-B-M25	Metal	Gold	●		NC*MBH-B	Black Metal	Gold	-	-	●
NC3FBV1-D		Metal	Gold	●	NC*FBV-D		Metal	Gold	-	●	●
NC3FBV1-B-D		Black Metal	Gold	●		NC*MBV	Metal	Gold	-	●	●
NC3FBV1-M25		Metal	Gold	●	NC*FBV-B-D		Black Metal	Gold	-	●	●
NC3FBV2-D		Metal	Gold	●		NC*MBV-B	Black Metal	Gold	-	-	●
NC3FBV2-B-D		Black Metal	Gold	●	NC5FBV-SW-D	NC5MBV-SW	Metal	Gold	-	-	●
NC3FBY-D	NC3MBY	Metal	Gold	●							
NC3FBY-B-D	NC3MBY-B	Black Metal	Gold	●	B / BA Series - D version come with disassembled Push latch, version with assembled latch omit -D.						
NC3FBH1-E-D	NC3MBV-E	Metal	Gold	●	B / BA Series rear mount only, all PCB mount except Y version = IDC						
NC3FBH2-E-D		Metal	Gold	●							
	NC3MBH-E	Metal	Gold	●							



Ordering Information for Receptacle

Female Male Shell Contact 3 4 5 6 7
pole pole pole pole pole

D Series

NC3FD-V	NC3MD-V	Nickel	Silver	●	-	-	-	-
NC3FD-V-B	NC3MD-V-B	Black Cr	Gold	●	-	-	-	-
NC3FD-V-BAG	NC3MD-V-BAG	Black Cr	Silver	●	-	-	-	-
NC3FDM3-V	NC3MDM3-V	Nickel	Silver	●	-	-	-	-
NC3FDM3-V-B	NC3MDM3-V-B	Black Cr	Gold	●	-	-	-	-
NC3FD-H	NC3MD-H	Nickel	Silver	●	-	-	-	-
NC3FD-H-B	NC3MD-H-B	Black Cr	Gold	●	-	-	-	-
NC3FD-H-BAG	NC3MD-H-BAG	Black Cr	Silver	●	-	-	-	-
NC3FDM3-H-D	NC3MDM3-H	Nickel	Silver	●	-	-	-	-
NC3FDM3-H-B-D	NC3MDM3-H-B	Black Cr	Gold	●	-	-	-	-
NC3FDM3-H-BAG-D	NC3MDM3-H-BAG	Black Cr	Gold	●	-	-	-	-

DL Series

NC*FD-L-1	NC*MD-L-1	Nickel	Silver	●	●	●	●	●
NC*FD-L-B-1	NC*MD-L-B-1	Black Cr	Gold	●	●	●	●	●
NC*FD-L-BAG-1	NC*MD-L-BAG-1	Black Cr	Silver	●	●	●	●	-
NC*FDM3-L-1-D	NC*MDM3-L-1	Nickel	Silver	●	●	●	-	-
NC3FDM3L-BAG-1-D	NC3MDM3L-BAG-1	Black Cr	Silver	●	-	-	-	-
NC3FD-L-1-HE	NC3MD-L-1-HE	Velour Cr	Gold	●	-	-	-	-
NC*FDM3-H-D	NC*MDM3-H	Nickel	Silver	-	●	●	●	-
NC*FDM3-H-B-D	NC*MDM3-H-B	Nickel	Silver	-	●	●	●	-
NC*FDM3-H-BAG-D	NC*MDM3-H-BAG	Black Cr	Silver	-	●	●	●	-
NC3FD-S-1-B	NC3MD-S-1-B	Black Cr	Silver	●	-	-	-	-

DLX Series

NC*FD-LX	NC*MD-LX	Nickel	Silver	●	●	●	●	●
NC*FD-LX-B	NC*MD-LX-B	Black Cr	Gold	●	●	●	●	●
NC*FD-LX-BAG	NC*MD-LX-BAG	Black Cr	Silver	●	●	●	-	-
NC*FD-LX-M3	NC*MD-LX-M3	Nickel	Silver	●	●	●	-	-
NC3FD-LX-HE	NC3MD-LX-HE	Velour Cr	Gold	●	-	-	-	-

DLX Crimp Series

NC3FD-LX-HA	NC3MD-LX-HA	Nickel	Silver	●	-	-	-	-
NC3FD-LX-HA-BAG	NC3MD-LX-HA-BAG	Black Cr	Gold	●	-	-	-	-

EMC XLR

NC3FDX-EMC-SPEC	Black Cr	Gold	●	-	-	-	-
-----------------	----------	------	---	---	---	---	---

Accessories

FDR-1	Black round panel mounting flange with screws for larger panel cut-outs
-------	---

Female Male Shell Contact 3 4 5 6 7
pole pole pole pole pole

P Series

NC*FP-1	Nickel	Silver	●	●	●	●	●
	NC*MP	Nickel	Silver	●	●	●	-
NC*FP-B-1	Black Cr	Gold	●	●	●	●	●
	NC*MP-B	Black Cr	Gold	●	●	●	-
NC*FP-BAG-1	NC*MP-BAG	Black Cr	Silver	●	●	●	-

MPR-HD Series

-	NC*MPR-HD	Nickel	Gold	●	●	●	-	-
---	-----------	--------	------	---	---	---	---	---

Combo A Series

						5	6	9	10
						pole	pole	pole	pole
NCJ6FA-H	Black plastic	Gold	-	●	-	-	-	-	-
NCJ6FA-H-0	Black plastic	Gold	-	●	-	-	-	-	-
NCJ6FA-V	Black plastic	Gold	-	●	-	-	-	-	-
NCJ6FA-V-0	Black plastic	Gold	-	●	-	-	-	-	-

Combo Series

NCJ*FI-H	Black plastic	Gold	●	●	●	●	●
NCJ*FI-H-0	Black plastic	Gold	●	●	●	●	●
NCJ*FI-S	Black plastic	Gold	●	●	●	●	●
NCJ*FI-S-0	Black plastic	Gold	●	●	●	●	●
NCJ*FI-V	Black plastic	Gold	●	●	●	●	●
NCJ*FI-V-0	Black plastic	Gold	●	●	●	●	●

Contact

	1	2	3	T	R	S	TN	RN	SN	G	GN
NCJ5FI-*	x	x	x	x		x				x	
NCJ6FI-*	x	x	x	x	x	x				x	
NCJ9FI-*	x	x	x	x	x	x	x	x	x	x	x
NCJ10FI-*	x	x	x	x	x	x	x	x	x	x	x

Panel Cutouts

A / AA / B / BA Series D / DL / DLX Series P Series Female P Series Male Combo MPR Series



Assembly Tools

HTXP Hand tool to tighten the XX and PX-bushing

BTXX Assembly fixture to tightening the XX-bushing



HX-R-BNC Crimp tool for XCC Series

DIE-R-BNC-PT Crimp die for XCC Series (6.5 mm HEX)



HX-R-HA Hand crimp tool incl. dies & locator for Crimp XLR





Plugs & Jacks

Content

Page

Plugs:		Jacks:	
1/4" Phone Plug - PX Series	33	Locking 1/4" Cable and Chassis Jacks	39
1/4" Phone Plug - Silent Plug	34	1/4" Vertical Jacks	40
1/4" Phone Plug - Crystal Plug	35	M Jacks	41
1/4" Professional Phone Plugs - P Series	35	Slim Jacks	42
MIL/B-Gauge Type Phone Plugs	35	Stacking Jacks	43
0.173" Bantam Type Miniature Plugs	36	Technical Data	44
3.5 mm Right-Angle Stereo Plug	36	Ordering Information	45
Technical Data	37	RCA Series	47
Accessories	37	Technical Data	48
Ordering Information	38		

Introduction

The Neutrik® plug and jack program offers a wide range of professional phone connectors including 1/4", 3.5 mm, MIL/B-gauge style and TT or bantam style plugs. The jack range offers an exceptional "slim" 1/4" PCB jack that is almost 20% smaller than most other designs. The heavy duty M line combines a wide range of options such as three different nose forms and four styles of contacts including 3 PCB and one solder tab. It also includes a 1/4" chassis and cable jack line with the secure locking feature, well known from the XLR range. All jacks are manufactured from strong high-grade thermoplastics and are available in all common versions which make them suitable for audio and industrial applications.

The plug line features:

- Mono (TS) and Stereo (TRS) plugs
- Straight and right-angle versions
- Rugged diecast shell in nickel or black chromium
- Nickel or gold plated contacts
- Chuck type strain relief
- Precision machined plugfinger without rivets
- Coloured boots and rings for coding
- True 3.5 mm stereo plug
- Silent Plug for instrument (guitar) applications

All plugs and jacks are specified to IEC 60603-11 and EIA RS-453 or the respective MIL standard.

Neutrik® also offers a special jack version which is a combined 3 pole XLR receptacle and a 1/4" phone jack for balanced mic or line inputs in one XLR shell. This "one for two" panel mount offers substantial cost, labour and material savings. For more information on the Combo products see page 20 or visit our website at www.neutrik.com.



Neutrik brand



Anti-kink bushing



Chuck type strain relief

1/4" Phone Plug - PX and PRX Series



NP2X



NP3X-B



NP3X + PXR-5



NP2RX-B

- Slim 1/4" plug with million fold proven chuck type strain relief
- Precision machined one piece contacts - no rivets
- Sleek attractive design for best handling convenience
- 14.5 mm only in diameter (right angle 15.4 mm) - serves highest packing density of 15.88 mm jack pitch
- Nickel or gold plugfinger in mono (TS) and stereo (TRS)

NP3X

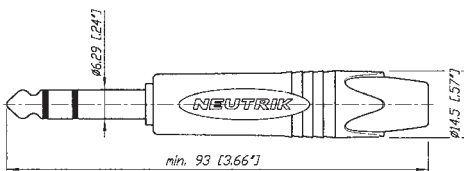

NP2RX

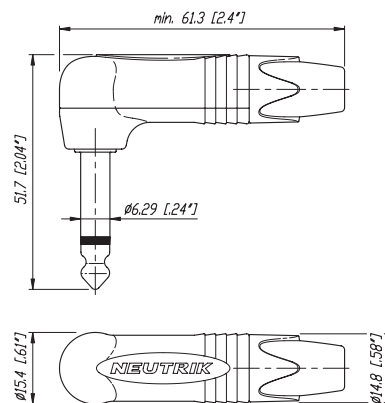

15.88 mm jack pitch:





Moving magnet



Right angle plug

Attention!

Use only for instrument (guitar) applications.
Connecting an amplifier output may blow your amp!

1/4" Phone Plug - Silent Plug

NEW



NP2X-AU-SILENT



NP2RX-AU-SILENT

- Avoid pops and squeals
- Hermetically sealed switching contacts
- Lifetime beyond 10'000 mating cycles
- Slim right-angle plug with industry proven and reliable chuck type cable strain relief
- Sleek attractive design for convenient handling and connections
- Rubber overlay on straight housing for best shock-protection and reliability

Detail Silent Switch:



REED SWITCH

- Cannot corrode or pollute
- No wear, constant contact resistance
- Decoupled from switching mechanism

Design Criteria

The Silent Plug automatically mutes (shorts) an instrument (guitar) cable to avoid pops and squeals when changing the instrument (guitar) under load.

The integrated silent switch (pat. pending) is based on REED-technology and guarantees a lifetime beyond 10'000 mating cycles.

NP2X-AU-SILENT

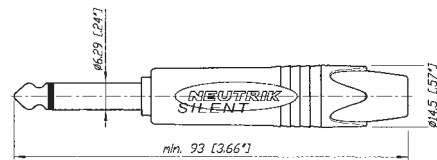

Plugs



Crystal stones



The standard of professional phone plugs



B-Gauge type

Crystal Plug



NP2X-B-CRYSTAL

- PX Series made with CRYSTALLIZED™ – Swarovski Elements
- Fancy, noble, valuable, attractive package - an eye-catcher

1/4" Professional Plugs



NP2C + BSP-3

- Available in mono (TS) or stereo (TRS)
- Meets EIA / IEC standards
- Unique plug finger design without rivets
- Sturdy diecast metal shell
- Excellent Neutrik® chuck type strain relief

MIL/B-Gauge Type Plugs



NP3TB-R

NP3CM-B

- 1/4 " "B-Gauge" and "MIL" Type Plugs
- All metal design, chuck type strain relief, no rivets
- Meet all prevailing standards
- Available as plug fingers only for overmolding

NP2X-B-CRYSTAL



NP3C

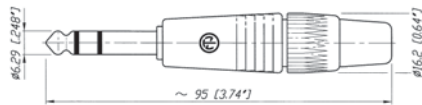

NP3TB-B

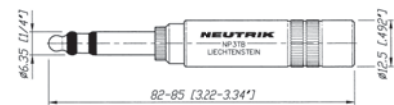

NP3CM-B



Plugs



Bantam plug



Dual bantam plug



Gold plated contacts



Easy connector assembly

0.173" Bantam Type Miniature Plugs



NP3TT-1-B



NP3TT-2

- Very robust ergonomic design
- Gold contact version in combination with the NJ3TTA jack eliminates contact problems due to corrosion or dirt
- The single plug NP3TT-P and the dual bantam plug NP3TT-2 are made for assembling with a standard HEX crimping tool as used with coax cables
- Solder termination for T + R, crimp termination for sleeve contact

NP3TT-1



NP3TT-P



3.5 mm Right-Angle Stereo Plug



NTP3RC

- The only available 3.5 mm plug with chuck type strain relief
- All metal housing - reliable and robust
- Easy to assemble, simple to use
- Slim design - space saving
- Excellent cable protection
- All Nickel or black housing, available with gold plated contacts

NTP3RC



Specifications	1/4" Phone Plugs SILENT & CRYSTAL	MIL / B-gauge Type	0.173" Bantam Type	3.5 mm Stereo Plugs
----------------	--------------------------------------	--------------------	--------------------	---------------------

Electrical

Rated current:	depends on mating connector	•	•	•	•
Contact resistance:	depends on mating connector	•	•	•	•
Insulation resistance: - initial:	> 2 GΩ	•	•	•	•
- after damp heat test:	≥ 1 GΩ	•	•	•	•
Dielectric strength	1 kV dc	•	•	•	•

Mechanical

Lifetime > 1'000 mating cycles		•	•	•	•
Wiring:	solder terminals	•	•	•	•
Wire size	mm ²	1	1 (NP3CM: 0.5)	0.25	0.22
	AWG	18	18 (NP3CM: 20)	24	24
Cable O.D.:	mm	4 - 7	4 - 7	4.8 max	2 - 4.5

Materials

Shell:	Zinc diecast (ZnAl4Cu1) Ni or black Cr plated	Brass (CuZn39Pb3) black or red coated	Brass (CuZn39Pb3) 2 μm Ni (Su) plated PA 6 30 % GR	Zinc diecast (ZnAl4Cu1) Ni or black Cr plated PA 6.6 15% GR
Insulation: Polyamide (PA 6.6 30 % GR)	•	•	•	•
Contacts: Brass (CuZn39Pb3) 2 μm Ni (Su) or Au plated	•	• or Brass	• (Tip: CuSn6) 2 μm TRIBOR® (NiP-AuCo)	•
Chuck:	POM	POM	-	POM
Bushing:	POM + PU	-	-	CuZn39Pb3 + PU (Ni or black Chrome)
Rubber shell-overlay:	EPDM	-	-	-

Environmental

Temperature range: -20 °C to +65 °C	•	•	•	•
Solderability: Complies with IEC 68-2-20	•	•	•	•

Accessories



BSP-*



BPX-*



PXR-*



BSTT-*



BSTP-*



PCR-*

BSP-*	Coloured bushing for NP*C Series	BSTP-*	Coloured sleeves for NP3TT-P Series
BPX-*	Coloured bushing for NP*X Series	PXR-*	Coloured marking rings for NP*X Series
BPX-L	Large bushing for NP*X Series up to 8.0 mm cable O.D.	PCR-*	Coloured marking rings for NP*C Series
BSTT-*	Coloured sleeves for NP3TT Series		

*: 0 - Black, 1 - Brown, 2 - Red, 3 - Orange, 4 - Yellow, 5 - Green, 6 - Blue, 7 - Violet, 8 - Grey, 9 - White; Must be ordered in multiples of 100.

Assembly tool

HX-TT-1	Assembly and crimp tool for NP3TT-1/AU
HX-R-BNC	HEX crimp tool for NP3TT-P*
DIE-R-BNC-PJ	HEX crimp die for NP3TT-P* (5.4 mm)
HTXP	Hand tool to tighten the PX and XX-bushing
HT-PXS	Hand tool to hold shell of PX Plug

Ordering Information

Part Number	Shell	Contacts	Standards Compatibility	Remarks
-------------	-------	----------	----------------------------	---------

1/4" Professional Phone Plugs - PX and PRX Series

NP2X	NP2RX	Nickel	Nickel	IEC 60603-11 / EIA RS-453	Mono plug, black bushing, chuck type strain relief
NP2X-BAG	NP2RX-BAG	Black Cr	Nickel	●	Mono plug, black bushing, chuck type strain relief
NP2X-B	NP2RX-B	Black Cr	Gold	●	Mono plug, black bushing, chuck type strain relief
NP3X	NP3RX	Nickel	Nickel	●	Stereo plug, black bushing, chuck type strain relief
NP3X-BAG	NP3RX-BAG	Black Cr	Nickel	●	Stereo plug, black bushing, chuck type strain relief
NP3X-B	NP3RX-B	Black Cr	Gold	●	Stereo plug, black bushing, chuck type strain relief
*-D					Bulk packed to be ordered in multiples of 100

SILENT Guitar Plug

NP2X-AU-SILENT	Rubber overlay	Gold	IEC 60603-11/EIA RS-453	Mono plug , chuck-type strain relief, silent switch
NP2RX-AU-SILENT	red coated	Gold	IEC 60603-11/EIA RS-453	right angle mono plug, chuck-type strain relief, silent switch

Crystal Plug

NP2X-B-CRYSTAL	Black Cr	Gold	IEC 60603-11/EIA RS-453	Mono plug, black bushing, chuck type strain relief, equipped with CRYSTALLIZED™ – Swarovski Elements
----------------	----------	------	-------------------------	--

1/4" Professional Phone Plugs - PC Series

NP2C	Nickel	Nickel	IEC 60603-11/EIA RS-453	Mono plug, black bushing, chuck type strain relief
NP2C-BAG	Black Cr	Nickel	●	Mono plug, black bushing, chuck type strain relief
NP2C/B	Black Cr	Gold	●	Mono plug, black bushing and gold contacts, chuck type strain relief
NP3C	Nickel	Nickel	●	Stereo plug, black bushing, chuck type strain relief
NP3C-BAG	Black Cr	Nickel	●	Stereo plug, black bushing, chuck type strain relief
NP3C/B	Black Cr	Gold	●	Stereo plug, black bushing and gold contacts, chuck type strain relief
NP2C-BAG-T-AU	Black Cr	Nickel + T: Gold	●	Mono plug, black bushing with gold tip, chuck type strain relief
NP2C-T10AA	Nickel	Nickel	●	Mono plug, red bushing, with built-in 1:10 transformer to convert microphone levels to guitar inputs, chuck type strain relief
NP2RCS	Nickel + black plastic	Nickel	●	Mono right-angle plug, black bushing, chuck type strain relief
NP3RCS	Nickel + black plastic	Nickel	●	Stereo right-angle plug, black bushing, chuck type strain relief
NP*C-D				Bulk packed to be ordered in multiples of 100

MIL/B-gauge Type Phone Plugs

NP3TB-B	Black	Nickel	B-GAUGE BP0316	1/4" B-Gauge plug, chuck type strain relief
NP3TB-R	Red	Nickel	●	1/4" B-Gauge plug, chuck type strain relief
NP3TM-B	Black	Nickel	MIL-P-642/2	1/4" MIL plug , chuck type strain relief
NP3TM-R	Red	Nickel	●	1/4" MIL plug , chuck type strain relief
NP2CM-B	Black	Brass	MIL-P-642/4	Mono 1/4" MIL plug, chuck type strain relief
NP2CM-R	Red	Brass	●	Mono 1/4" MIL plug, chuck type strain relief
NP3CM-B	Black	Brass	MIL-P642/5A	Stereo 5.23 mm (0.206") MIL plug, chuck type strain relief
NP3CM-R	Red	Brass	●	Stereo 5.23 mm (0.206") MIL plug, chuck type strain relief

0.173" Bantam Type Miniature Plugs

NP3TT-1-B	Nickel + black plastic	Nickel	MIL-P-642/13	4.4 mm (0.173") Bantam plug with solder contacts, black sleeve
NP3TT-1-R	Nickel + red plastic	Nickel	●	4.4 mm (0.173") Bantam plug with solder contacts, red sleeve
NP3TT-AU-B	Nickel + black plastic	Gold	●	4.4 mm (0.173") Bantam plug with solder contacts, black sleeve
NP3TT-AU-R	Nickel + red plastic	Gold	●	4.4 mm (0.173") Bantam plug with solder contacts, red sleeve
NP3TT-P-B	Black plastic	Nickel	●	4.4 mm (0.173") Bantam plug with solder contacts, black sleeve
NP3TT-P-R	Red plastic	Nickel	●	4.4 mm (0.173") Bantam plug with solder contacts, red sleeve
NP3TT-P-AU-B	Black plastic	Gold	●	4.4 mm (0.173") Bantam plug with solder contacts, black sleeve
NP3TT-P-AU-R	Red plastic	Gold	●	4.4 mm (0.173") Bantam plug with solder contacts, red sleeve
NP3TT-2	Black plastic	Nickel	●	4.4 mm (0.173") Twin Bantam plug with solder contacts, black sleeve

3.5 mm Right-Angle Stereo Plug

NTP3RC	Nickel	Nickel	IEC 60603-11	3.5 mm audio plug with chuck and bushing
NTP3RC-B	Black Cr	Gold	IEC 60603-11	3.5 mm audio plug with chuck and bushing



Locking Jacks



1/4" cable jack with locking



Release latch

Locking 1/4" Cable Jacks



NJ3FC6



NJ3FC6-BAG

- Securely locking cable jack
- Mates with all mono or stereo plugs specified to EIA RS-453
- Extremely robust and reliable
- Excellent Neutrik cable retention
- Coloured boots available in 10 colours
- For cable O.D. up to 8 mm

Locking 1/4" Chassis Jacks



NJ3FP6C



NJ3FP6C-BAG

- Mates with all mono or stereo plugs specified to EIA RS-453
- Dimensionally compatible with D Series (31 x 26 mm)
- Securely locking chassis jack
- Solder terminals
- Special version with black plastic shell
- Choice of grounding option

NJ3FC6

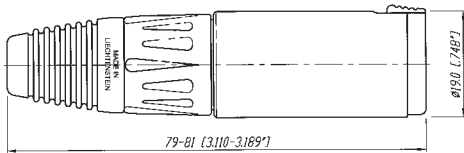

NJ3FP6C

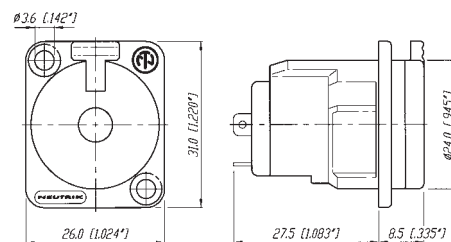



Snapping cap



Solder tags

1/4" Vertical Jacks



NJ*FD-V



NJ6TB-V



- Quick Cap Fixing System reduces assembly time drastically through snapping mounting cap
- Retention force is provided by a special spring element, independent from contacts
- All common circuits available
- Two versions for mating of plugs acc. to EIA RS-453 (NJ*FD-V) or B-gauge BP0316 (NJ*TB-V)

NJ*FD-V

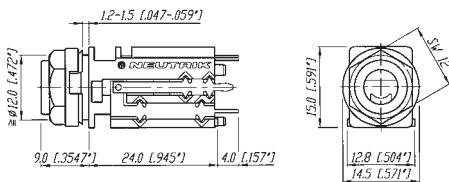

* ... 2, 3, 5, 6



Half threaded nose



Chrome ferrule



Plastic nut

M Jacks



NMJ4HHD2



NMJ2HC-S



NMJ6HFD2

- Wide body and extremely durable contacts
- Available in all common versions:
 - mono
 - stereo
 - switched
 - unswitched
- Hardwire and PCB version
- Nose type in
 - half threaded
 - fully threaded
 - chrome ferrule
- Full threaded and chrome nose M Jacks are supplied with washer and fixing nut
- Mounting hardware for half threaded nose must be ordered separately
- Fascia appearance in plastic or chrome

NMJ6HHD2



NMJ4HC-S



NRJ-NUT-B



NRJ-WB (washer)



NMJ6HFD2

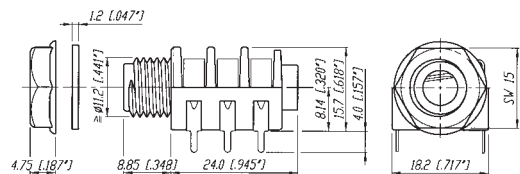

Horizontal PCB Jacks



Half threaded nose



Chrome nose



Chassis ground contact



Gold plated contact

Slim Jacks



NRJ4HH-1



NRJ6HF-1



NRJ6HM-1-AU



NRJ-NUT-B



NRJ-NUT-MK



NRJ-NUT-MS



NRJ-NUT-MN
(Metal Nose only)

- High board packing densities
- Nose type in
 - half thread
 - fully threaded
 - metal
- Meeting the requirements of EMC rules through efficient chassis grounding system
- Retention spring ensures optimum grip on inserted plugs, avoiding the chance of lost connection
- All Slim line jacks have PCB horizontal mount pins
- Mounting nuts in different versions available - must be ordered separately

NRJ-NUT-B



NRJ-NUT-MK

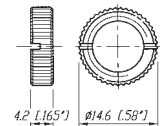

NRJ-NUT-MS



NRJ-NUT-MN
(Metal Nose only)



NRJ4HH-1



NRJ4HF-1

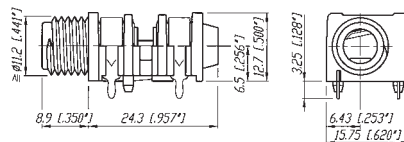

NRJ6HM-1



PCB Mount Stacking Jacks



Plane nose



Quick fix nose



Quick fix nut



Fully threaded nose

Stacking Jacks



NSJ8HC



NSJ12HL



NSJ12HH-1



NSJ12HF-1

- Mono and stereo dual slim jack socket for PCB mounting with switch contacts
- Mounting method by either two quick fix or threaded

- Highest board packing density as two jacks are in a single footprint, fit in 1 RU
- Version in fully and half threaded nose, full nose and quick-fit

NSJ8HC



NSJ12HL



NSJ-NUT-B

(Quick fix nut)



NSJ12HH-1

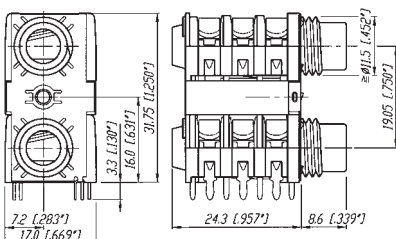

NSJ12HF-1

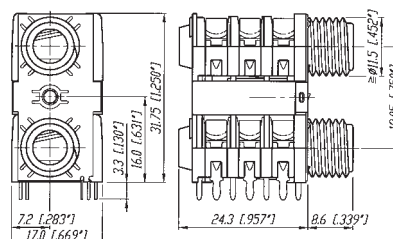

NRJ-NUT-B



Specifications

	Vertical Jack	Locking Cable & Chassis Jack	M Jack	Slim Jack	Stacking Jack
--	---------------	------------------------------	--------	-----------	---------------

Electrical

Contact resistance	- initial:	< 10 mΩ	< 6 mΩ	< 15 mΩ	< 10 mΩ	-
	- Top row:	-	-	-	-	< 15 mΩ
	- Bottom row:	-	-	-	-	< 10 mΩ
Switch contact resistance:	- for silver:	-	-	< 30 mΩ	< 25 mΩ	-
	- for gold:	< 15 mΩ	-	-	< 10 mΩ	-
	- Top row:	-	-	-	-	< 15 mΩ
	- Bottom row:	-	-	-	-	< 10 mΩ
Insulation resistance:	≥ 1GΩ @ 500 V dc	●	●	●	●	●
Dielectric strength	1 kV dc	●	●	●	●	●
Rated current:		3 A	10 A	3 A	3 A	3 A
Rated switch contact current:		0.25 A @ 12 V	N/A	0.5 A @ 50 V	0.5 A @ 50 V	0.5 A @ 50 V

Mechanical

Lifetime	> 10'000 cycles	●	●	●	●	●
Insertion / withdrawal force:	< 10 N / > 8 N	< 20 N / < 20N	< 20 N / > 10 N	< 20 N / > 10 N	< 20 N / > 10 N	< 20 N / > 10 N
Cap opening torque:	25 N cm / 9.84 N in	-	-	-	-	-
Locking force:		-	> 80 N	-	-	-
Wire size:		-	1 mm ² / 18 AWG [Ⓞ]	-	-	-
Cable O.D. (FC6 only)		-	3.5 - 8.0 mm	-	-	-
Solderability complies with IEC 68-2-20:		●	●	●	●	●
Standard Compatibility:						
EIA RS 453 + IEC 60603-11	NJ*FD	●	●	●	●	●
B-GAUGE BPO 316, MIL-J-641/3	NJ*TB	-	-	-	-	-
Panel thickness:	1.2 - 1.5 mm [0.047 - 0.06"]	-	-	-	-	-
	- Full nose type:	-	-	< 3.0 mm	< 3.0 mm	-
	- Half nose type:	-	-	< 1.0 mm	< 1.0 mm	-
	- Chrome nose:	-	-	< 4.7 mm	-	-
	- NSJ*HL:	-	-	-	-	1.0 - 1.6 mm
	- NSJ*HC:	-	-	-	-	> 1.0 mm

Material

Shell / Handle:	PA 6.6 30% GR	ZnAl4Cu1 Ni plated or black coated	PA 6.6 15% GR	PA 6 15% GR	PA 6 15% GR
	- FP6P:	-	PA 6.6 30% GR	-	-
Insulation:		-	-	-	-
Contacts:	CuSn6	CuBe2/CuZn37 (ground)	Ni-Silver	CuSn6	CuSn6
Contact surface:	0.2 μm Au	2 μm Ag	-	gal 2 μm Ag / 0.2 μm Au	gal 2 μm Ag
Cap / Nut / Washer:	POM	-	PA 6.6 15% GR	PA 6.6 15% GR	PA 6.6 15% GR
Ring Nut:	-	-	-	Brass (Ni plated)	Brass (Ni plated)
Chuck:	-	POM	-	-	-
Bushing:	-	PA 6.6 15% GR + PUR	-	-	-
Temperature range:	-25°C to +70°C	●	●	●	●
Ⓞ... max. for soldering tag					

Circuits:



Part Number	Shell	Contacts	Terminations	Standards Compatibility	Remarks
-------------	-------	----------	--------------	-------------------------	---------

Slim Jack

PCB Mount Sockets - Switched

NRJ3HF-1	Black/Plastic	Silver	Horizontal PCB soldering	IEC 60603-11/EIA RS 453	Mono, full threaded nose, chassis ground contact
NRJ4HF	●	●	●	●	Mono, full threaded nose
NRJ4HF-1	●	●	●	●	Mono, full threaded nose, chassis ground contact
NRJ6HF	●	●	●	●	Stereo, full threaded nose
NRJ6HF-1	●	●	●	●	Stereo, full threaded nose, chassis ground contact
NRJ4HH	●	●	●	●	Mono, half threaded nose
NRJ4HH-1	●	●	●	●	Mono, half threaded nose, chassis ground contact
NRJ6HH	●	●	●	●	Stereo, half threaded nose
NRJ6HH-1	●	●	●	●	Stereo, half threaded nose, chassis ground contact
NRJ6HF-AU	●	Gold	●	●	Stereo, full threaded nose, gold plated contacts
NRJ6HF-1-AU	●	Gold	●	●	Stereo, full threaded nose, chassis ground contact, gold plated contacts
NRJ6HH-AU	●	Gold	●	●	Stereo, half threaded nose, gold plated contacts
NRJ-NUT-B	●	-	-	-	Hexagonal black plastic nut
NRJ-NUT-R	Red/Plastic	-	-	-	Hexagonal red plastic nut
NRJ-NUT-MK	Metal/Ni plated	-	-	-	Metal ring nut, knurled
NRJ-NUT-MS	Metal/Ni plated	-	-	-	Metal ring nut

PCB Mount Sockets - Switched with Metal Nose

NRJ4HM-1	Black/Plastic	Silver	Horizontal PCB soldering	IEC 60603-11/EIA RS 453	Mono, metal threaded nose
NRJ4HM-1-AU	●	Gold	●	●	Mono, metal threaded nose, gold plated contacts
NRJ6HM-1	●	Silver	●	●	Stereo, metal threaded nose
NRJ6HM-1-AU	●	Gold	●	●	Stereo, metal threaded nose, gold plated contacts
NRJ-NUT-MN	Metal	-	-	-	Hexagonal metal nut (for metal nose jack only)

Stacking Jack

NSJ8HL	Polyamid PA 6.6 GR	Silver	Horizontal PCB soldering	IEC 60603-11/EIA RS 453	Mono, quick fix nose
NSJ12HL	●	●	●	●	Stereo, quick fix nose
NSJ8HC	●	●	●	●	Mono, full nose
NSJ12HC	●	●	●	●	Stereo, full nose
NSJ12HF-1	●	●	●	●	Full threaded nose
NSJ12HH-1	●	●	●	●	Half threaded nose
NSJ-NUT-B	Black/Plastic	-	-	-	Quick fix nut

All Slim jacks are for PCB mount only.

Mounting nuts must be ordered separately, except for Stacking Jack type NSJ8HL and NSJ12HL.

Ordering Key:

NRJ*H	NEUTRIK Jack Horizontal	*	number of contacts:
H	half threaded nose	2	mono unswitched
F	full threaded nose	4	mono switched
L	quick fix nose	6	stereo switched
M	metal threaded nose	8	mono stacking jack
C	plane nose	12	stereo stacking jack
-1	chassis ground contact		

Nose:

-H



-F



-M



-L



-C



Ordering Information

Part Number	Shell	Contacts	Terminations	Standards Compatibility	Remarks
-------------	-------	----------	--------------	-------------------------	---------

1/4" Locking Jack

NJ3FC6	Nickel	Silver	Wire soldering	IEC 60603-11/EIA RS 453	Cable Jack
NJ3FC6-BAG	Black	●	●	●	●
NJ3FP6C	Nickel	●	●	●	Chassis Jack
NJ3FP6C-B	Black	Gold	●	●	●
NJ3FP6C-BAG	Black	Silver	●	●	●
NJ3FP6F-P	Nickel	●	●	●	●
NJ3FP6P-BAG	Black/Plastic	●	●	●	Plastic Chassis

Accessories

DSS-*	Lettering plate, coloured plastic		NDJ	Dummy-plug for 1/4" chassis jack	
SCDR	Rear end protection cover for locking 1/4" chassis jack	 Example	SCDX	Hinged cover seals 1/4" chassis jack, IP42 rated	 Example

1/4" Vertical Jack

NJ2FD-V	Black/Plastic	Gold	Vertical PCB soldering	IEC 60603-11/EIA RS 453	Non-switching Mono Jack (T/S)
NJ3FD-V	●	●	●	●	Non-switching Stereo Jack (T/R/S)
NJ5FD-V	●	●	●	●	2 x switching (normalling) Stereo jack (T/TN/R/RN/S)
NJ6FD-V	●	●	●	●	3 x switching (normalling) Stereo jack (T/TN/R/RN/S/SN)
NJ6TB-V	●	●	●	B-Gauge BPO316 Mil-J-641/3	3 x switching (normalling) Stereo jack (T/TN/R/RN/S/SN)

M Jack

NMJ2HF-S	Black/Plastic	Silver	Horizontal PCB soldering	IEC 60603-11/EIA RS 453	Mono, unswitched, full threaded nose, solder tags
NMJ3HF-S	●	●	●	●	Stereo, unswitched, full threaded nose, solder tags
NMJ4HF-S	●	●	●	●	Mono, switched, full threaded nose, solder tags
NMJ2HC-S	●	●	●	●	Mono, unswitched, Chrome ferrule, solder tags
NMJ4HC-S	●	●	●	●	Mono, switched, Chrome ferrule, solder tags
NMJ4HFD2	●	●	●	●	Mono, switched, full threaded nose, PCB mount
NMJ4HFD3	●	●	●	●	Mono, switched, full threaded nose, offset PCB mount
NMJ4HCD2	●	●	●	●	Mono, switched, Chrome ferrule, PCB mount,
NMJ4HHD2	●	●	●	●	Mono, switched, half threaded nose, PCB mount, without nut and washer
NMJ6HF-S	●	●	●	●	Stereo, switched, full threaded nose, solder tags
NMJ6HC-S	●	●	●	●	Stereo, switched, Chrome ferrule, solder tags
NMJ6HCD2	●	●	●	●	Stereo, switched, Chrome ferrule, PCB mount
NMJ6HHD2	●	●	●	●	Stereo, switched, half threaded nose, PCB mount, without nut and washer
NMJ6HFD2	●	●	●	●	Stereo, switched, full threaded nose, PCB mount
NMJ6HFD3	●	●	●	●	Stereo, switched, full threaded nose, offset PCB mount
NMJ6HCD3	●	●	●	●	Stereo, switched, Chrome ferrule, offset PCB mount
NMJ6HFD4	●	●	●	●	Stereo, switched, full threaded nose, tear drop PCB mount

Full threaded and Chrome nose M-Jacks are supplied with fixing nut and washers. Mounting hardware for half threaded nose must be ordered separately.

Ordering Key:

NMJ*H	NEUTRIK M Jack Horizontal	* number of contacts:
H	half threaded nose	2 mono unswitched
F	fully threaded nose	3 stereo unswitched
C	chrome nose	4 mono switched
-S	solder tag	5 stereo switched (T/S)
D2	PCB pins 02	6 stereo switched (T/R/S)
D3	PCB pins 03	
D4	PCB pins 04	





Gold plated contacts



Soft-touch surface



Phono socket

Profi® RCA Series

NEW



NF2C

- Makes ground before signal contact and breaks signal before ground
- No more disturbing noise and broken speaker cones
- Precisely machined to our demanding quality standards
- Neutrik unique chuck type strain relief
- Gold plated contacts
- Sleek barrel with soft touch surface and coloured shrink sleeve
- Improved ground solder lug for ease soldering

NF2C



Phono Socket



NF2D-4



NF2D-B-6

- Makes ground before signal contact and breaks signal before ground
- No more disturbing noise and broken speaker cones
- Precisely machined to our demanding quality standards
- Gold plated contacts

NF2D-*



* available in 9 colours see page 48

Specification	Profi®	Phono Socket
---------------	--------	--------------

Electrical

Rated current per contact:	16 A rms continuous	●	●
Rated insulation voltage:	50 V ac	●	●
Contact resistance:		> 100 GΩ	< 5 GΩ
Dielectric strength:		1500 V dc	500 V dc
Capacitance (pin to shell):		7 pf	9 pf

Mechanical

Life time (mating cycles):	> 5000	●	●
Cable O.D. range:	3.0 - 7.3 mm	●	-
Wiring:	soldering	●	●
Max. wire size :	2.5 mm ² / 14 AWG	●	-
Cable anchoring:	Neutrik® chuck type strain relief	●	-
Solderability:	complies with IEC 68-2-20	●	●

Material

Housing:	Brass (CuZn39Pb3)	●	-
	Zinc diecast (ZnAlCu1)	-	●
Insert:	PBTP 20% GR	●	-
Contacts:	Brass (CuZn39Pb3)	●	●
Contact plating:	5 μm Au plated over 5 μm Ni	●	●
Chuck:	Polyacetal (POM)	●	-

Environment

Temperature range:	-30°C to +80°C	●	●
Protection class:	IP 40	●	●
Flammability:	UL 94 HB	●	●

Ordering Information

Phono Profi®

NF2C-B2	Professional "phono Plug" (RCA or CINCH type), two plugs with red and black coding, two strain relief chucks for a second cable diameter
---------	--

Phono (RCA) Socket

NF2D-*	Chassis Phono (RCA) socket in D Shape housing
NF2D-B-*	Chassis Phono (RCA) socket in black D Shape housing
* color coding: 0 - Black, 1 - Brown, 2 - Red, 3 - Orange, 4 - Yellow, 5 - Green, 6 - Blue, 7 - Violet, 8 - Grey, 9 - White	

Accessories

NDP	Dummy plug for phone socket
SCL	Plastic sealing cover to protect the connector sockets against dust and moisture
SCDX	Hinged cover seals D-size chassis connectors, IP54 rated



Loudspeaker Connectors

Content

Page

Speakon® SPX Series 4 Pole Cable Connector	51	Speakon® STX Series Cable Connector	58
Speakon® FC Series, 2, 4 and 8 Pole Cable Connector	53	Speakon® STX Series Chassis Connector.....	59
Speakon® Adapter	54	Technical Data	61
Speakon® Chassis Connector	55	Wiring	62
Speakon® Combo	57		

Introduction

The Neutrik® Speakon® Series, in the Pro Audio industry often called "The loudspeaker connector", became the state of the art for speaker and amplifier connections.

Invented by Neutrik® as a result of various customer requests, the first Speakon® had been introduced in 1987. The pro audio market realized very quickly the advantages of this completely new connection system. The design has been optimized for loudspeaker applications with an outstanding cost-performance ratio.

As market leader for speaker connections we are proud to offer an all-embracing product line for the specific needs of this market today. Latest designs as the STX series or the Speakon® Combo also meet the demands of niche applications or extremely rough conditions and complete the product range.

Integrated Design

Neutrik's aim to be distinctively recognizable is realized by the technological head start on the one hand as well as both patent and trademark protection on the other hand.



To draw a clear line between Neutrik® and competition products we give our customer the possibility to easily identify the original.

Therefore all of our new products as the SPX and the STX series are designed according the protected integrated design. (EU-Pat.: DM/057 379, US-Pat. Pending, CHINA-Pat.: 0230519 2.2/193.0/194.9/195.7)



Features & Benefits

Today's Speakon® series is a result of a continuous product improvement process. The principal idea has been kept and optimized with material and design modifications over the years.

A traditional Speakon® stands for:

- Reliable and robust, easy and fast to assemble
- 2, 4 and 8-pole cable and chassis connectors in various versions
- Optimal "Quick Lock" system for speaker applications
- Neutrik® proven and unique chuck type cable strain relief
- Outstanding cost-performance ratio
- Defacto standard
- Meets all Worldwide Safety requirements (IEC, UL, ...)

Beyond that, the latest designs as the SPX and STX series offer:

- Up to 50 Amps current rating
- Only 3 parts with 1 piece strain relief design for even easier assembly
- Convertable right-angle version
- Weatherproof and extremely robust all metal design
- Complete system, 4 pole female chassis and male cable connector



Quick lock



Chuck type strain relief



Right angle conversion



Speakon® SPX Series 4 Pole Cable Connector



NL4FX



NL4FRX

Features

- Up to 50 A current rating
- Only 3 parts, easy to assemble
- High Impact Materials

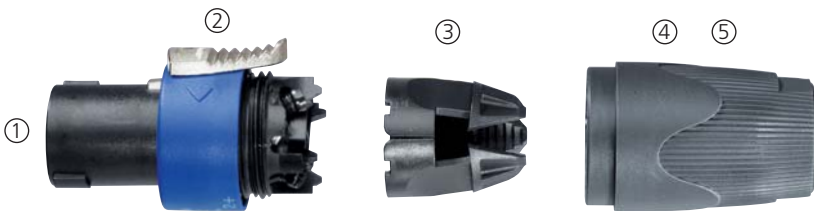

- ① Easy and extremely precise locking system "Quick Lock"
- ② Improved grip on latch
- ③ 1 piece strain relief, chuck for 6 to 14.5 mm cable O.D.
- ④ Color coding possible
- ⑤ Integrated design guaranties "Made by Neutrik®"

Improved SPX-Series screw contacts! (Wire position after assembly.)



- ① Progressive clamping as wire is pushed forward
- ② Acts as screw locking device due to side forces
- ③ Large combi drive - M4 screw
- ④ Wire size 1.5 - 4 mm² (AWG 12) for 6 mm² (AWG 10) remove screw & solder
- ⑤ Pull out force > 300 N @ 80 cNm
- ⑥ Gas tight connection



NL4FX



NL4FRX

Design Criteria

This second generation of Speakon® connectors features higher current rating for the operation of high power speakers and amplifiers carrying more than 1000 Watts. Only 3 parts make it fast and easy to assemble with a more reliable

performance. Our unique design makes it possible to change easily and quickly from a straight connector to the right-angle version, even without disconnecting the cable.

Assembly

Prepare cable as shown.



HINT:

For easy wiring especially of thick cables, first screw on the inner contacts 1+ and 2+ and afterwards the outer contacts 1- and 2- !
Use screwdriver Pozidrive #1 only.



Ordering Information

NL4FX	Cable Connector with chuck and bushing
NL4FX-2	Cable Connector with chuck and red bushing
NL4FX-4	Cable Connector with chuck and yellow bushing
NL4FX-5	Cable Connector with chuck and green bushing
NL4FX-9	Cable Connector with chuck and white bushing
NL4FRX	Right-angle Cable Connector with chuck and bushing

Accessories



LCR-*



LRX

LCR-*	Coloured coding rings for the right-angle version of the SPX Series. Available in blue (Standard), white, red, green and yellow.
LRX	Right-angle Speakon® Conversion Kit for changing the straight connector into a right-angel version without removing the cable from the insert.



Locking ring



Quick lock



Speakon® FC Cable Connector Series



NL2FC

NEW



NL4FC



NL8FC

- 4 pole - Branded with unique hologram - guarantees genuine and authentic Neutrik product
- Up to 30 A rms current rating
- Glass reinforced materials for housing and inserts
- Unique Neutrik® chuck type strain relief
- Precise keyway for secure mating
- Accurate twist lock latching system
- 4 pole in new design with more ergonomic latch

Keying:



NL2FC



NL4FC



NL8FC



Ordering Information

NL2FC	2 pole Cable Connector with locking ring, integrated cable clamp, intermates with 4-pole chassis connector and makes contact with +1/-1
NL4FC	4 pole Cable Connector with latch lock
NL8FC	8 pole Cable Connector with latch lock
Accessories	
BSL-*	Coloured bushing for NL4FC



1/4" Jack adapter



Extension coupler

Speakon® Adapter



NA4LJ



NL4MMX



NL8MM

NL4MMX

Features permanent secure connection on a Speakon® cable connector using 2nd lock.



Secure Lock!

NL4MMX + NL4FX (locked on the cable)

Changes gender to male when permanently locked on the cable.



NA4LJ

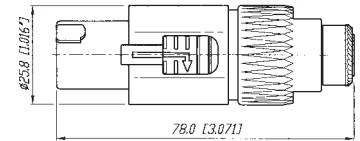

NL4MMX

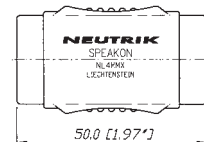
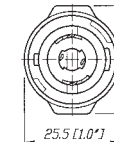

NL8MM

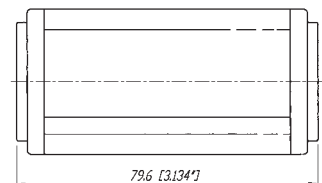
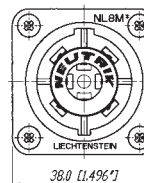

Ordering Information

NA4LJ	Adapter from Speakon® Cable Connector to 2 pole 1/4" Jack, wiring: +1 to TIP and -1 to SLEEVE
NL4MMX	4 pole lockable coupler to extend two 4-pole cables
NL8MM	8 pole coupler to extend two 8-pole cables



Reinforced locking area



Nickel housing



3/16" flat tabs



Vertical PCB mount



Speakon® Chassis Connector



NL2MP



NL4MD-H-1



NL4MD-H-3



NL4MPR



NL8MPR

- Standard version up to 30 A rms, ultra high current version up to 50 A audio current
- Glass reinforced materials
- Precise keyway for secure mating
- Accurate twist lock latching system
- Metal front plate (8-pole) or metal insert in locking area (2 & 4-pole)
- Various mounting and wiring possibilities
- "Air tight design", optimized for speaker applications
- D or G panel cutouts to be easily mounted on audio industry standard panels
- 4 pole branded with unique hologram

NL4MD-V



NL4MD-H



NL4MP



NL4MPR



NL8MPR



Ordering Information

Flange layout:

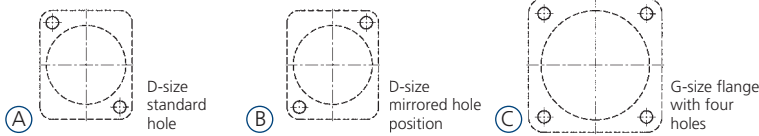

Hole layout:

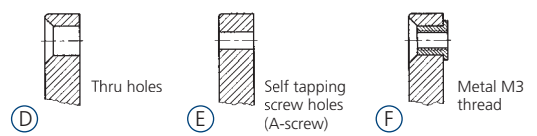

	Pole	Flange size	Flange layout	Hole layout	Color	Wiring	Remarks
NL2MP	2	D-size	A	D	black	3/16" flat tabs*	Does not intermate with 4-pole cable connector
NL2MD-H	2	D-size	A	D	black	horizontal PCB	Does not intermate with 4-pole cable connector
NL2MD-V	2	D-size	A	D	black	vertical PCB	Does not intermate with 4-pole cable connector
NL4MP	4	D-size	A	D	black	3/16" flat tabs*	
NL4MP-1	4	D-size	A	E	grey	3/16" flat tabs*	
NL4MP-2	4	D-size	B	E	black	3/16" flat tabs*	
NL4MP-3	4	D-size	A	E	black	3/16" flat tabs*	
NL4MP-M3	4	D-size	A	F	black	3/16" flat tabs*	
NL4MD-H	4	D-size	A	E	grey	horizontal PCB	
NL4MD-H-1	4	D-size	A	D	black	horizontal PCB	
NL4MD-H-2	4	D-size	B	E	black	horizontal PCB	
NL4MD-H-3	4	D-size	A	E	black	horizontal PCB	
NL4MD-V	4	D-size	A	D	black	vertical PCB	
NL4MD-V-1	4	D-size	A	E	grey	vertical PCB	
NL4MD-V-2	4	D-size	B	E	black	vertical PCB	
NL4MP-ST	4	D-size	A	D	black	screw terminal	
NL4MP-UC	4	D-size	A	D	black	1/4" flat tabs*	Ultra high current, up to 40 A rms
NL4MPR	4	round G-size flange	C	D	black	3/16" flat tabs*	
NL8MD-V	8	square G-size flange	C	D	Ni	vertical PCB	
NL8MD-V-BAG	8	square G-size flange	C	D	black chrome	vertical PCB	
NL8MD-V-1	8	square G-size flange	C	E	Ni	vertical PCB	
NL8MPR	8	square G-size flange	C	D	Ni	3/16" flat tabs*	
NL8MPR-BAG	8	square G-size flange	C	D	black chrome	3/16" flat tabs*	
NLT4MP	4	square G-size flange	C	D	nickel	1/4" flat tabs*	
NLT4MP-BAG	4	square G-size flange	C	D	black chrome	1/4" flat tabs*	
NLT4MD-V	4	square G-size flange	C	E	nickel	vertical PCB	
NLT4FP	4	square G-size flange	C	D	nickel	solder contacts	
NLT4FP-BAG	4	square G-size flange	C	D	black chrome	solder contacts	
NLT8MP	8	square G-size flange	C	D	nickel	1/4" flat tabs*	
NLT8MP-BAG	8	square G-size flange	C	D	black chrome	1/4" flat tabs*	

*: flat tabs to be used with FASTON® connectors or to solder the wire (FASTON® is a trademark of AMP Inc.)

Accessories



A-Screw-1-8	Black self tapping PLASTITE® screw 2.9 x 8 for rear panel mount
BSL-*	Coloured bushing for NL4FC
NLFASTON	FASTON® receptacle for tabs with "positiv lock" for use with NL4MP, NL4MPR, NL8MPR, Pack of 100 pcs.
MFD	M3 mounting frame for D-size chassis
NDL	Dummy plug for 2 & 4 Pole chassis connector
SCL	Plastic sealing cover to protect the connectors against dust and moisture
SCDR	Rear end protection cover for D-size chassis connectors
SCDX	Hinged cover seals D-size chassis connectors, IP42 rated





PCB solder pins



Locking key



Speakon® Combo



NLJ2MD-V



Combines a Speakon® and 1/4" Phone Jack - one for two

- D-size flange
- Compatible PCB layout and panel mount to NL4MD-V-1 (NL4MD-H)
- Cost saving - combines two connectors in one housing
- Mates with all 2, 4-pole Speakon® and 1/4" Phone Plugs
- PA-wiring: 1+ is connected to TIP, 1- to the SLEEVE

NLJ2MD-V



Ordering Information

NLJ2MD-V	2 pole Chassis Connector, vertical PCB mount
NLJ2MD-H	2 pole Chassis Connector, horizontal PCB mount

Assessories

A-Screw-1-8	Black self tapping Plastite® screw 2.9 x 8 for rear panel mount
SCL	Plastic sealing cover to protect the connectors against dust and moisture
SCDX	D-size hinged cover
MFD	M3 mounting frame for D-size chassis



Reinforced locking



Latch lock



XL-solder contacts

Speakon® STX Series Cable Connectors



NLT4FX-BAG



NLT4MX



NLT8FX

Features

- Up to 50 A current rating
- Only 3 parts, easy to assemble
- All metal housing
- IP 54 sealing gasket



- ① Easy and extremely precise locking system "Quick Look", reinforced with metal
- ② Improved grip on latch
- ③ 1 piece strain relief, chuck for cables from 9 to 16 mm O.D.
- ④ Extreme rugged "Touring Approved"
- ⑤ Rubber sealing boot
- ⑥ Integrated Design guarantees "Made by Neutrik®"
- ⑦ X-large solder contacts for up to 6 mm² (AWG 10) wires

NLT4FX



NLT8FX





Robust metal housing



XL-solder contacts

Speakon® STX Series Chassis Connectors



NLT4FP-BAG



NLT4MP



NLT4MD-V



NLT8MP-BAG

- Extremely robust metal housing designed for harsh and demanding environment
- Weatherproof design features sealing gaskets
- 4 type range - also male cable connector and female receptacle on 4-pole version
- All-metal housing makes the STX Series rugged and durable
- Weatherproof built-in gasket meets IP 54 protection class (4 pole)
- Ideal product for touring applications and harsh environments
- Best electrical performance up to 50 Amps audio current
- Uses precise "Quick Lock" system
- Mates with all currently available Speakon® products
- 4 pole version has UL Recognized components, CSA listed

NLT4FP

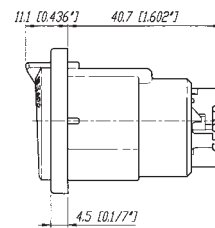

NLT4MP

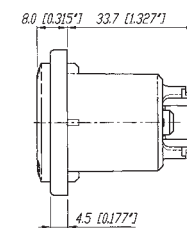

NLT8MP

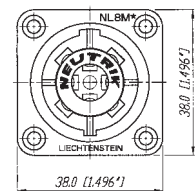
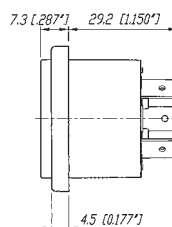

Design Criteria

The new Speakon® STX Series is the next generation of 4 & 8 pole Speakon® connectors especially designed for loudspeaker - amplifier applications in harsh and demanding environment such as professional touring.

The STX Series features a metal housing which is extremely

rugged and durable; built-in gaskets make it weatherproof. This new series offers beside the female cable connector and male receptacle now also a 4 pole male cable and female chassis connector.

Ordering Information

Cable Connectors

NLT4FX	4 pole female cable connector, nickel metal housing, chuck and bushing
NLT4FX-BAG	4 pole female cable connector, black-chrome metal housing, chuck and bushing
NLT4MX	4 pole male cable connector, nickel metal housing, chuck and bushing
NLT4MX-BAG	4 pole male cable connector, black-chrome metal housing, chuck and bushing
NLT8FX	8 pole female cable connector, nickel metal housing, chuck and bushing
NLT8FX-BAG	8 pole female cable connector, black-chrome metal housing, chuck and bushing

Receptacles

NLT4FP	4 pole female chassis connector, nickel metal housing, solder contacts
NLT4FP-BAG	4 pole female chassis connector, black-chrome metal housing, solder contacts
NLT4MP	4 pole male chassis connector, nickel metal housing, 1/4" flat tabs*
NLT4MP-BAG	4 pole male chassis connector, black-chrome metal housing, 1/4" flat tabs*
NLT4MD-V	4 pole male chassis connector, nickel metal housing, PCB contacts
NLT8MP	8 pole male chassis connector, nickel metal housing, 1/4" flat tabs*
NLT8MP-BAG	8 pole male chassis connector, black-chrome metal housing, 1/4" flat tabs*

*: flat tabs to be used with FASTON® connectors or to solder the wire (FASTON® is a trademark of AMP Inc.)

Accessories



A-Screw-1-8



SCNLT



Example: SCNLT + NL4MP



SCL



NDL

A-Screw-1-8	Black self tapping Plastite® screw 2.9 x 8 for rear panel mount
SCNLT	Gasket for NLT4MP (To make a cabinet with an Amphenol EP cutout airtight, the rubber scaling covers the entire hole.)
SCL	Plastic sealing cover to protect the connectors against dust and moisture
NDL	Dummy plug for 4 Pole chassis connector

Specification	SPX Series Cable Con.	STX Series Cable Con.	Speakon® FC Cable Con.	Speakon® Chassis + Combo	Adapter	STX Series Chassis
---------------	-----------------------------	-----------------------------	------------------------------	--------------------------------	---------	--------------------------

Electrical

Number of contacts:	4	4 + 8	2, 4, 8	2, 4, 8	2, 4, 8	4 + 8	
Rated current per contact:	40 A rms continuous	•	•	30 A	30 A	15 A	•
	50 A audiosignal, duty cycle 50%	•	•	40 A	40 A	30 A	•
Combo:	15 A rms continuous	-	-	-	•	-	-
Rated insulation voltage:	250 V ac	•	•	•	•	•	•
Contact resistance after lifetime:	< 2 mΩ	•	•	≤ 3	≤ 3	≤ 3	•
Insulation resistance after dampheat:	> 1 GΩ	•	> 10 GΩ	•	•	•	> 10 GΩ
Dielectric strength:	4 kV peak	•	•	•	•	•	•
1/4" Jack:	1.5 kV peak	-	-	-	-	•	-

Mechanical

Locking System:	Quick lock (latch)	•	•	•	•	•	•
Life time (mating cycles):	> 5'000	•	•	•	•	•	•
Cable O.D. range:	mm						
2 Pole		-	-	6 - 10	-	-	-
4 Pole		7 - 14,5	-	5 - 15	-	-	-
8 Pole		-	8 - 20	8 - 20	-	-	-
Wiring:	screw type terminals	4 mm² (AWG 12)	-	4 mm² (AWG 12)	• (ST)	-	-
	soldering	6 mm² (AWG 10)	6 mm² (AWG 10)	4 mm² (AWG 12)	•	-	•
	flat tabs for 3/16" FASTON® (4.8 x 0.5 mm)	-	-	-	•	-	-
	flat tabs for 1/4" FASTON® (6.3 x 0.8 mm)	-	-	-	• (UC)	-	•
	PCB-version	-	-	-	•	•	•
Insertion / withdrawal force:	Combo Jack: ≤ 20 N / > 10 N	-	-	-	-	•	-
Cable retention force:	≥ 220 N*	•	•	•	-	-	-
Solderability:	complies with IEC 68-2-20	•	•	•	•	•	•

*: subject to cable O.D. and material

Material

Housing:	Polyamide PA 6 30% GR	-	-	•	•	•	-
	PBTP 20% GR	•	-	-	-	-	-
	Zinc diecast (ZnAlCu1)	-	•	-	-	-	•
Insert:	Polyamide PA 6 30% GR	-	•	-	-	•	•
	PBTP 20% GR	•	-	•	-	-	-
Contacts:	Brass (CuZn39Pb3)	•	•	•	-	-	-
	Bronze (CuSn6)	-	-	-	•	•	-
	Spring copper	-	•	-	• (UC)	-	•
Contact plating:	4 μm Ag	•	•	•	•	•	•
Locking Element:	Zinc diecast (ZnAl4Cu1)	•	•	•	-	-	• (FP)
Chuck:	Polyacetal (POM)	•	•	•	-	-	-
Bushing:	Polyamide (PA 6 15% GR)	•	•	•	-	-	-

Environment

Temperature range:	-30°C to +80°C	•	•	•	•	•	•
Protection class:	IP 54 (mated condition)	-	•	-	-	-	•
	IP 52 (8-pole, mated cond.)	-	•	-	-	-	•
Flammability:	UL94HB	•	•	•	•	•	•
Safety Requirements:	EN/IEC 61984	•	•	•	•	•	•
Approvals:	UL-Recognized, CSA listed	•	4 pole	•	•	•	4 pole

Wiring Suggestion

Positive signal on speaker pin "+" produces positive wave-form from driver (moves cone outwardly)

"+" = In phase (high) "-" = Ground (out of phase, low)
Lower numbers for lower frequencies.

	AMPLIFIER	CABLE	SPEAKER
Stereo ("HiFi")	one NL4MP socket left channel pins 1+/1- right channel pins 2+/2-	NL4FC on amplifier end, four conductor cable splits into two pairs with NL4FX on each end	one NL4MP per speaker left speaker pins 1+/1- right speaker pins 2+/2-
POWER ("PA") Standard	three NL4MP sockets "A" socket: left channel pins 1+/1- "B" socket: right channel pins 1+/1-	a two-conductor cable for each channel with NL4FX on both ends	NL4MP pins 1+ to speaker coil "+" NL4MP pins 1- and 2+ to speaker coil "-"
Bridged mono	"M" socket: left channel pins 1+/1- right channel pins 2+/2-	a special two-conductor cable, on both ends wired to pin 1+/2+ of NL4FX	NL4MP pin 1+ to speaker coil "+" NL4MP pins 1- and 2+ to speaker coil "-"
Bi-Amp	one NL4MP socket low frequency pins 1+/1- high frequency pins 2+/2-	a four-conductor cable on both ends wired to pins 1+/1-, 2+/2- of NL4FX	one NL4MP socket low frequency pins 1+/1- high frequency pins 2+/2-
4 Way System	one NL8MPR socket low frequency pins 1+/1- low mid frequency pins 2+/2- high mid frequency pins 3+/3- high frequency pins 4+/4-	an eight-conductor cable wired on both ends to pins 1+/1-, 2+/2-, 3+/3-, 4+/4- of NL8FC	one NL8MPR socket low frequency pins 1+/1- low mid frequency pins 2+/2- high mid frequency pins 3+/3- high frequency pins 4+/4-





Data Connectors

Content

Page

OpticalCon® - Cable Connector Assembly	65	EtherCon® - CAT6	77
OpticalCon® - Chassis Connector	66	Technical Data EtherCon® - CAT6	78
OpticalCon® - Coupler	66	Ordering Information EtherCon® - CAT6	78
Technical Data OpticalCon®	68	USB and Firewire Adapter	79
Ordering Information OpticalCon®	70	Technical Data USB and Firewire Adapter	80
EtherCon® - Cable Carrier	72	Ordering Information USB and Firewire Adapter	80
EtherCon® - Receptacles	73		
Technical Data EtherCon®	75		
Ordering Information EtherCon®	76		

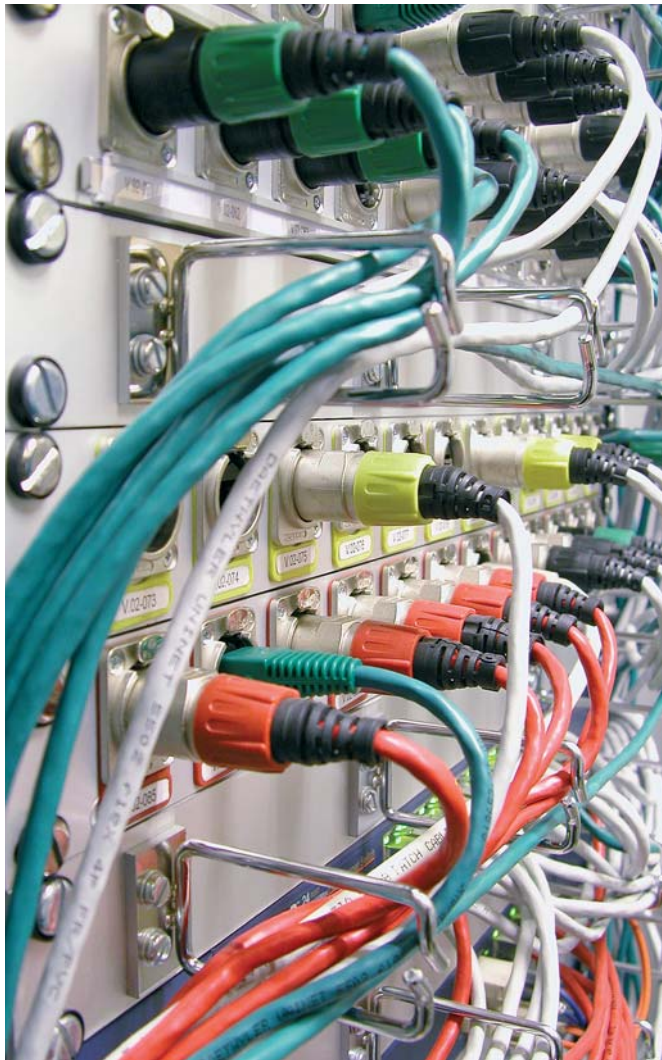

Introduction

Neutrik's data connector range copes with the increasing demand of digital connections in the professional audio and entertainment industry. Digitalization in the audio business for networking and computerized controls requires also reliable and rugged interconnection systems. Neutrik® early understood this trend and realized Pro Audio proof connector systems based on standard digital interconnection products like fiber optic, Ethernet, USB or Firewire. The Neutrik® data connector line fulfils the stringent requirements of the Pro Audio market and offers ruggedized and reliable optical and RJ45 cable and chassis connectors as well as USB and Firewire panel mount connectors.

Example of EtherCon® RJ45 Data Connector.

Design Criteria

During the past few years signal digitalization found its way into the Pro Audio & Entertainment business, revolutionizing equipment and applications.

Nowadays one fiber optic cable can transmit hundreds of channels, is light and easy to pass, and avoids grounding problems or noises.

The weak spot has been again the connector. Fragile fiber optic network connectors like the ST, SC, LC etc. are optimized for a one time permanent connection but can not meet the rough requirements of the entertainment industry. Military extended beam lens coupling connectors are very expensive and have the disadvantage of an extensive attenuation increase.

Neutrik®, as Pro Audio & Video technology leader when it comes to connectors, kept up with the time and developed a suitable fiber optic connection system - the OpticalCon®.

The system is based on a standardized optical LC-Duplex connection but eliminates its weakness and guarantees a safe and rugged connection.

Because of the compatibility with conventional LC connectors it offers the choice of using a cost effective LC connector as a permanent connection (e.g. patch cable) or our rugged OpticalCon® cable connector for mobile applications. The system enables a run of up to 4 copper wires for power supply or any data signal, a special SMPTE-version has been optimized for broadcast applications and offers an additional ground-shell contact. The chassis connector acts as "feed through" and guarantees a simple installation by simply connecting a conventional LC-Duplex connector (e.g. with a permanent installation cable) on the rear.

The cable connector comes pre-assembled onto a choice of mobile field cables, currently 5 types and their variations (Multimode, Singlemode, APC) can be offered in any length.



Rugged metal housing



Cable drum

Cable Connector Assembly

**NEW
IP65**



NKO2M-4S75

- Ruggedized and dirt protected fiber optic connection system
- Waterproof acc. to IP65
- Cable connector comes pre-assembled with a choice of five mobile field cables
- Range of cables include rugged hybrid (fiber + 4 copper wires), robust and lightweight mobile field cable with 2 multi- or singlemode fibers, a 4 pole Y-split and a SMPTE type cable
- Accommodates standard optical LC-Duplex connectors
- Cable connector features rugged all metal housing and heavy duty cable retention
- Excellent dust and dirt protection due to automatic sealing shutter with silicone gasket
- Reliable Push-Pull locking mechanism
- Easy to clean, no tools required
- Cable packed in case, on drum or air spool
- Field repairable

NKO2M-4S75*

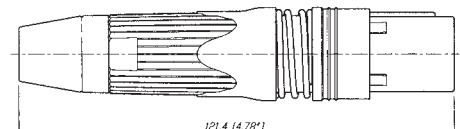
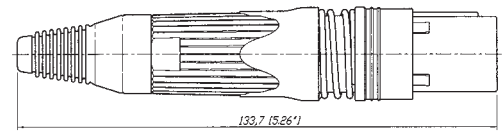



Rear LC connection



Sealed housing



Coloured coding to identify fiber mode



Chassis Connector

NEW
IP65



NO2-4FDW

- Designed as feedthrough with automatic sealing shutter
- Shutter with silicone gasket protects optical connection from dust and dirt
- Waterproof acc. to IP65 ingress protection
- Rubber sealing gasket (black, blue, green)
- Accommodates standard LC connectors on the rear for simple installation
- Connection on the front side either by rugged OpticalCon® or standard LC connector
- Colour coding to identify fiber mode
 - Multimode – black
 - Singlemode PC – blue
 - Singlemode APC – green

NO2-4FDW



Coupler

NEW
IP65



NAO2S-4S75W

- OpticalCon® coupler (adapter) in „D“ size housing for cable extensions
- Available in three versions - LC-Duplex multi and single mode (PC and APC) all with 4 copper wires

NAO2M-4S75W



Features and Benefits



- ① Sealing gasket
- ② 4 additional female copper contacts
- ③ Mates and locks also with standard LC-Duplex connectors



Sealing cover, gaskets protect the optical connection from dust and dirt.



- Wiring:
- ④ Big solder cups (AWG 18)
 - ⑤ Mates with conventional LC-Duplex



- ⑥ Dirtprotection



- ⑮ Coloured sealing gasket identifies fiber mode



- ⑦ All metal rugged housing
- ⑧ Sealing shutter (inside)
- ⑨ Push-Pull locking mechanism
- ⑩ Standard LC-Duplex connector, easy to clean
- ⑪ 4 additional copper contacts
- ⑫ Heavy duty cable retention
- ⑬ All metal bushing
- ⑭ Cable protection boot
- ⑯ Sealing ring

Technical Data OpticalCon® Connectors

Optical			Cable Connector	Chassis Connector
Optical connector			LC-Duplex	LC-Duplex Feedthrough
Fiber		Multimode, Singlemode PC, Singlemode APC	●	●
Insertion loss		< 0.5 dB / connection	●	●
Mechanical				
Insertion / withdrawal force		< 45 N	●	●
Lifetime		> 1'000 cycles	●	●
Cable retention force	2M-4S75	500 N	●	-
	2S/2M	500 N	●	-
	SMPTE	350 N	●	-
	4 MY	300 N	●	-
Electrical				
Number of electrical contacts			4	4 (5)
Rated current		6 A	NKO2M-4S75*	●
		10 A (contact 1+4)	NKO2S(A)-SMPTE*	●
Contact resistance		< 7 mΩ	●	●
Insulation resistance	- initial:	> 10 GΩ	●	●
	- after damp heat test:	> 1 GΩ	●	●
Dielectric strength		1500 V dc	●	●
Rated voltage		50 V ac	● ¹	● ¹
Material				
Shell	Zinc diecast (ZnAl4Cu1)	(hard Nickel or Ruthenium plating)	●	●
Insert / Insulation		Polyamid PA 6, PBT 30% GR, PBT 50% GR	●	●
Contacts	- male:	Brass (CuZn39Pb3)	●	-
	- female:	Bronze (CuSn6)	-	●
Contact surface		Gold (gal 0.2 μm Au over 2 μm Ni)	●	●
Strain relief		POM (brass)	●	-
Bushing		ZnAl4Cu1	●	-
Boot		EPDM, rubber boot	●	-
Slit sleeve		ceramics	-	●

Environmental

Operating temperature	-25°C to +75°C	flammability UL94 HB	●	●
Solderability complies with IEC 68-2-20			●	●

¹ ... Not compatible to SMPTE 304M standard. Suitable for indoor (studio) camera links considering specific conditions acc. to IEC 60664-1 like pollution degree 1, overvoltage category 1 and rated voltage. For detailed information ask for the White Paper "OpticalCon @ SMPTE Indoor Applications".

Technical Data Fiber Cables

		2M	2S	2SA	4MY	2M-4S75	2S-S1	2SA-S1
Attenuation:	@ 850 nm	3 dB/km			3.5 dB/km	2.5 dB/km		
	@ 1300 nm	1 dB/km			1.5 dB/km	0.7 dB/km		
	@ 1310 nm		0.5 dB/km	0.5 dB/km			0.45 dB/km	0.45 dB/km
	@ 1550 nm		0.5 dB/km	0.5 dB/km			0.5 dB/km	0.5 dB/km
Bandwidth:	@ 850 nm	500 MHz-km			500 MHz-km	500 MHz-km		
	@ 1300 nm	500 MHz-km			500 MHz-km	500 MHz-km		
	@ 1310 nm							
	@ 1550 nm							
Refraction index:	@ 850 nm	1.468			1.468	1.482		
	@ 1300 nm	1.468			1.468	1.477		
	@ 1310 nm		1.458	1.458			1.468	1.468
	@ 1550 nm		1.458	1.458			1.468	1.468



Technical Data Mobile Fiber Cables



	2M	2S	2SA	4MY
Number of Fibers	2	2	2	4
Fiber type	Multimode	Singlemode	Singlemode	Multimode
Core diameter	50 µm	9 µm	9 µm	50 µm
Cladding diameter	125 µm	125 µm	125 µm	125 µm
Copper wires	-	-	-	-
Outer shield	-	-	-	-
Strength member	-	-	-	-
Cable retention	Aramid yarn	Aramid yarn	Aramid yarn	Aramid yarn
Overall diameter	5 mm	5 mm	5 mm	9.5 mm
Jacket	PUR	PUR	PUR	PUR
Optical connector	LC-Duplex	LC-Duplex	LC-Duplex	2 x LC-Duplex
Type	Multimode	Singlemode PC	Singlemode APC	Multimode
Colour	black, matte	black, matte	black, matte	black, matte
Min. bending radius	4 cm	4 cm	4 cm	10 cm
Weight	23 kg/km	23 kg/km	23 kg/km	103 kg/km
Wiring				

Technical Data Mobile Hybrid Cables



	2M-4S75	2S-S1	2SA-S1
Number of Fibers	2	2	2
Fiber type	Multimode	Singlemode	Singlemode
Core diameter	50 µm	9 µm	9 µm
Cladding diameter	125 µm	125 µm	125 µm
Copper wires	4 x AWG 18 (0.75mm ²)	2 x AWG 24 + AWG 16	2 x AWG 24 + AWG 16
Outer shield	-	Copperbraid-Tinned	Copperbraid-Tinned
Strength member	GFK	Stainless Steel	Stainless Steel
Cable retention	Aramid yarn	Crimp type	Crimp type
Overall diameter	8.9 mm	9.2 mm	9.2 mm
Jacket	PUR	PVC	PVC
Optical connector	LC-Duplex	LC-Duplex	LC-Duplex
Type	Multimode	Singlemode PC	Singlemode APC
Colour	black, matte	black, matte	black, matte
Min. bending radius	10 cm	10 cm	10 cm
Weight	78 kg/km	118 kg/km	118 kg/km
Wiring			

Ordering Information

Coding of Mobile Cables

Find a convenient OpticalCon® part number generator on www.neutrik.com

N K O 2 M - 4 S 7 5 - R - 1 F - 1 5 0 (Example)



Length [m]

Gender: No suffix ... Male-Male; F ... Male-Female

Packaging 0 to 4

Plating: No suffix ... hard Nickel; R ... Ruthenium

Cable (Assembled)

Neutrik® Optical Cable

Gender

Male-Male



Standard product (two cable ends)

Male-Female



wired chassis connector for cable extension (one cable end)

Cable

Field cable + copper

2 pole field cable

SMPTE cable

4 pole Y-split cable

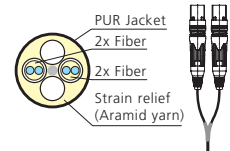

	Field cable + copper	2 pole field cable	SMPTE cable	4 pole Y-split cable
Multimode PC (black)	2M-4S75 ²⁾	2M	-	4MY ^{1) 2)}
Singlemode PC (blue)	-	2S	2S-S1 ²⁾	-
Singlemode APC (green)	-	2SA	2SA-S1 ²⁾	-

¹⁾ ...Gender: Male-male only (no suffix)

Packaging

0 ... Airspool



1 ... OpticalCon Case



2 ... Drum Schill GT310



3 ... Drum Schill GT380



4 ... Drum Schill HT582



²⁾ ...Packaging "2" not possible

Chassis Connectors

Chassis Connectors	Colour	Plating	Fiber	Solder contacts	Shell ground contact
NO2-4FDW	*	hard Nickel	2 x	4 x	-
NO2-4FDW-R	*	Ruthenium	2 x	4 x	-
NO2-4FDW-1	*	hard Nickel	2 x	4 x	1 x
NO2-4FDW-1-R	*	Ruthenium	2 x	4 x	1 x

* ... Coloured labeling to indicate the fiber mode included.

Coupler

Coupler	Colour (fiber mode)	Plating	Fiber	Copper wire
NAO2M-4S75W	black	black	LC-Duplex Multimode PC	4 x 0.75 mm ²
NAO2S-4S75W	blue	black	LC-Duplex Singlemode PC	4 x 0.75 mm ²
NAO2SA-4S75W	green	black	LC-Duplex Singlemode APC	4 x 0.75 mm ²



Accessories



NDO



SCDR



SCDX



Field repair toolkit

NDO	Dummy plug for OpticalCon chassis connector
SCDR	Rear end protection cover for D-size chassis connectors
SCDX	Hinged cover seals D-size chassis connectors, IP42 rated
Field repair toolkit	find more details on www.neutrik.com

OpticalCon® Wiring and hook up suggestion

In order to achieve uniform and compatible systems we recommend to follow the hook up suggestions of the ISO / IEC 11801 which defines channel A (right) as input and B (left) as output.



Extract of the ISO / IEC 11801 Patch cord termination configuration

It is recommended that connection of patch cords and equipment cords to the duplex adapter be made by means of a duplex connector assembly.

Optical fibre patch cords, whether they are used for cross-connection or interconnection to equipment, shall be of a cross-over orientation such that Position A goes to Position B on one optical fibre, and Position B goes to Position A on the other optical fibre of the optical fibre pair (Figure 17). Each end of the optical fibre patch cord shall be identified to indicate Position A and Position B if the connector can be separated into its simplex components. For alternate connector designs utilising latches, the latch defines the positioning in the same manner as the keys.

For simplex connectors, the connector that plugs into the receiver shall be considered Position A, and the connector that plugs into the transmitter shall be considered Position B.



Figure 17 - Optical

Legend:



Note: Shading for clarification only

Ruggedized RJ45 Data Connector

Ethercon® provides solutions for data transfer in harsh and demanding applications. These connectors are especially applicable for Ethernet networking in audio, commercial, entertainment, live stage production, DMX lighting, industrial and outdoor internet access environments.

The Ethercon® series offers male cable carriers, assembled female receptacles, feedthrough jacks, cable coupler and shielded versions with or without illumination possibilities by LEDs. The male cable end offers a rugged diecast metal shell as a carrier for pre-assembled RJ45 plugs, which does not require the re-termination of the cable assembly. Female chassis receptacles are based on the current Neutrik® "A & B" series as well the "D" series of XLR receptacles with secure latching system - a feature not found on other RJ45 receptacles. Terminations include horizontal and vertical PCB or IDC. Colour coding is available for both the cable carriers and the receptacles for ease of identification.

Neutrik® Ethercon® receptacles comply with CAT5e (IDC versions) or Class D (PCB versions), shielded or unshielded according to TIA / EIA 586B and ISO / EC 11801 standard.

EtherCon chassis overview

	Class D	CAT 5e	CAT 6
	Fastethernet 10/100 Base-T	Gigabit 1000 Base-T	10 Gigabit (IP54)
PCB mount	NE8FAV NE8FBV NE8FDV NE8FAH NE8FBH*	NE8FDH-C5E	
IDC		NE8FAV-Y* NE8FDV-Y*	NE8FDY-C6
Feedthrough		NE8FDP NE8FF	



Rugged diecast shell



Bushing

Cable Carriers



NE8MC + BSE*



NE8MC-1 + BSE*

- The RJ45 system for harsh and demanding environment
- Cable connector carrier accepts the most common RJ45 plugs
- Cable carrier has rugged diecast shell and unique chuck type strain relief
- NE8MC-1 version with weatherproof Collinox plating and O-ring gasket
- Protects Ethernet connections in a variety of commercial type applications and is designed to prevent breakage of the fragile components of standard RJ45 connectors
- Cable carrier does not include RJ45 plug

NE8MC

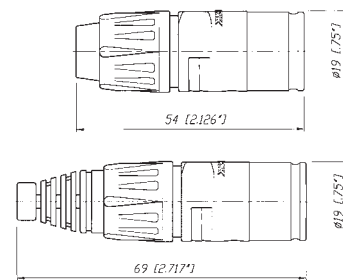

NE8MC-1

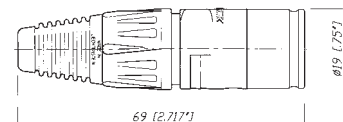



Horizontal PCB



Vertical PCB



IDC Terminals

Receptacles



NE8FAV + ACRF-2



NE8FBH



NE8FAV-YK



NE8FDV



NE8FDV-Y110-B



NE8FDH-C5E

- "A / B" and "D" sized receptacles available in vertical and horizontal PCB or IDC terminations
- Accommodates NE8MC carriers or any standard RJ45 Plug
- D-versions with unified metal flange equal to "D" series- XLR, Speakon®, PowerCon® and BNC Bulkhead

- Receptacles comply with Class D (PCB versions) or CAT 5e (IDC versions and NE8FDH-C5E) according to TIA / EIA 568B and ISO / IEC 11801 standard
- D-versions mountable from the front or rear of the panel
- Version with screw domes to fix connector onto PCB securely (NE8FAV-SD)

NE8FAV



NE8FAV-SD



NE8FBH

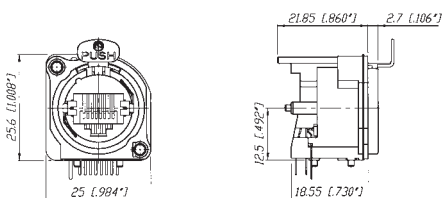

NE8FAV-YK



NE8FAV-Y110



NE8FDV





Completely closed housing



Light pipe



NE8FDP rear side



Locking latch

Shielded & Lighted



NE8FBH-S



NE8FBH-LED

- Comprehensive shielding granted by completely closed metal housing
- Improves EMC performance of appliance even in unmated condition
- Lighted version offers in addition various illuminating indication possibilities by means of two separate light pipes
- Light pipes illuminated by standard 3 mm LEDs - to be mounted on PCB by customer

Feedthrough



NE8FDP



NE8FF

- Feedthrough as panel mount receptacle and as cable coupler
- NE8FDP feedthrough connector in D series housing for use in patchfields - rear side accommodates standard RJ45 plug
- NE8FF coupler (adapter) for cable to cable mating - use with NE8MC carriers or any standard RJ45 plugs

NE8FBH-S

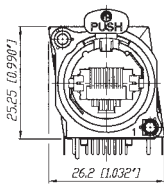

NE8FBH-LED



NE8FDP

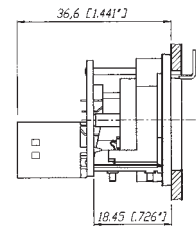
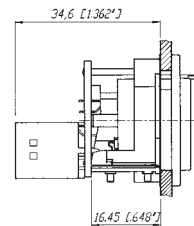
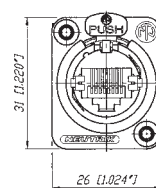

NE8FF

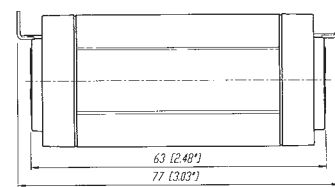
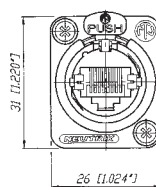

Specification		NE8MC* Cable Con.	NE8FA/B* (A + B Series)	NE8FD* (D Series)
Electrical				
Number of contacts		- ¹⁾	8	8
Rated current per contact	> 1.5 A	- ¹⁾	●	●
Rated voltage	< 50 V ac	- ¹⁾	●	●
Contact resistance	< 10 mΩ	- ¹⁾	●	●
Insulation resistance	> 500 MΩ	- ¹⁾	●	●
Dielectric strength	> 1'000 V ac rms	- ¹⁾	●	●
Frequency bandwidth	1 - 100 MHz	- ¹⁾	●	●
Transmission class acc. TIA / EIA 568B or IEC 11801	CAT 5e	- ¹⁾	●	● NE8FDH-C5E
	Class D	- ¹⁾	PCB Versions	PCB Versions
				NE8FDV
Mechanical				
Retention method	latch lock	●	●	●
Life time (mating cycles)	> 1'000 mating cycles	●	●	●
	> 200 mating cycles	-	-	SE8FD
Insertion / withdrawal force	≤ 20 N	●	●	●
Cable O.D. range	3.5 - 8 mm	●	-	-
Wire size	AWG 26 - 20	- ¹⁾	NE8*-Y*	NE8*-Y*
Panel thickness	max. 3 mm / 0.12"	-	●	4 mm / 0.16"
Material				
Housing	PBT D202G30	-	●	●
	Zinc diecast (ZnAlCu1, gal Ni / bl Cr / Collinox)	●	-	-
B / D-flange	Zinc diecast (ZnAlCu1, gal Ni / bl Cr)	-	●	●
Strain relief clamp	POM	●	-	-
	CuZn35Pb2, Tin plated	-	NE8*-Y*	NE8*-Y*
Contacts	Bronze (CuSn6)	- ¹⁾	●	●
Contact surface	Au (gal 0.2 μm over Ni plating)	- ¹⁾	●	●
Locking Element	Ck 67 steel, treated	-	●	●
Bushing	Polyamide (PA 6 15% GR)	●	-	-
Boot	Polyamide (PA 6)	●	-	-
Sealing gasket	EPDM	-	-	SE8FD
Environment				
Operating Temperature	-30°C to +80°C	●	●	●
	-20°C to +60°C	-	-	SE8FD
Protection class	IP54	-	-	SE8FD
Flammability	UL94 HB	●	●	●
Solderability complies with IEC 68-2-20		-	PCB Version	PCB Version
Mating screw		-	A screw	E screw
Colour coding		BSE-* / BSX-*	ACRF-*	DSS-*

¹⁾...Specs depend on type of RJ45 plugs used

Ordering Information

Cable Connector

NE8MC	Cable housing with chuck and bushing (two antikink boots, one up to 5 mm and one up to 8 mm cable O.D.) (standard bushing in black, 9 different coding colours on request)
NE8MC-B	Black chromium housing with chuck and bushing (two antikink boots, one for 5 mm and one for 8 mm cable O.D.) (standard bushing in black, 9 different coding colours on request)
NE8MC-1	Cable housing with chuck and X-series bushing, Collinox plating and O-ring gasket (perfect for waterproof applications) (standard bushing in black, 9 different coding colours on request)
NE8MC-B-1	Black chromium housing with chuck and X-series bushing (standard bushing in black, 9 different coding colours on request)
IMPORTANT:	Cable connectors do not include RJ 45 plug. RJ 45 cable assembly must be provided by end-user!

Receptacle	A-shape (all plastic)	B-shape (Nickel ring)	D-shape
Horizontal PCB	NE8FAH	NE8FBH	
Vertical PCB	NE8FAV	NE8FBV	NE8FDV
Vertical PCB with additional screw domes	NE8FAV-SD**		
IDC terminals	NE8FAV-YK**		NE8FDV-YK**
IDC 110 punch down terminals	NE8FAV-Y110**		NE8FDV-Y110**
Horizontal PCB with metal housing (shielded)		NE8FBH-S	
Horizontal PCB in CAT5e			NE8FDH-C5e
Horizontal PCB with metal housing and light pipe		NE8FBH-LED	
** ... includes 2 mounting screws			

Feedthrough

NE8FDP	Receptacle (includes 2 mounting screws)
NE8FF	Coupler

Accessories

							
A screw	E screw	E screw Nickel	ACRF-*	DSS-*	BSE-*	BSX-*	SCDX
A-Screw	Mounting screw for A / B -shape (black self-tapping PLASTITE® screw 2.9 x 8, panhead)						
E-Screw	Mounting screw for D-shape (black self-tapping PLASTITE® screw 2.9 x 12, countersunk)						
E-Screw-Ni	Mounting screw for D-shape (Nickel self-tapping PLASTITE® screw 2.9 x 12, countersunk)						
ACRF-*	Coloured coding rings for A-shape receptacles (Box of 100 pcs.)						
BSE-*	Coloured boot for cable connector carrier (Box of 100 pcs.)						
BSX-*	Coloured bushing for NE8MC-1 and NE8MC-B-1 cable connectors						
DSS-*	Lettering plate for D series, coloured plastic						
SCDX	Hinged cover seals D-size chassis connectors, IP42 rated						
*: 0 - Black, 1 - Brown, 2 - Red, 3 - Orange, 4 - Yellow, 5 - Green, 6 - Blue, 7 - Violet, 8 - Grey, 9 - White							

Waterproof kit for EtherCon® D-Series

	
Waterproof assembly kit - SE8FD	
SE8FD	Waterproof kit, IP 54, consists of push, gasket, frontplate Suitable for all NE8FD*, perfect in combination with NE8MC-1 (with Collinox plating and sealing gasket)



D-shape metal shell



Closed shielding



Push Pull locking



IP65 in mated condition

CAT6 Receptacles



NE8FDY-C6



NE8FDY-C6-B

CAT6 Patch Cable



NKE6S-*

- CAT6 compliant - data rate up to 10 GBit/s
- IP 65 rated - with dust and waterproof resistant sealing
- Push Pull mating design provides secure locking system
- Shielded system - high noise immunity and EMI protection
- IDC contacts offer gas-tight termination
- Ready made patch cables with rugged diecast cable carrier and unique chuck-type strain relief

NE8FDY-C6



NKE6S-*



NKE6S-*-WOC



Design Criteria

The ruggedized RJ45 CAT6 connection system, provides solutions for high bandwidth data transfer in harsh and demanding environments. This series offers additional headroom for high performance Fast Ethernet 100BaseT and Gigabit Ethernet 1000BaseT connectivity in audio, lighting, live stage and industrial environments and even guarantees to be prepared for future 10 Gbit applications (true CAT6). The EtherCon CAT6 series offers a D-shape panel connector with metal housing and secure latching system. Tool-free IDC termination makes cable assembly easy and fast. The preassembled CAT6 patch cables use a shielded S/FTP cable with cable plug carrier offering a robust metal shell and Push-Pull locking system. Integrated sealing rings make the system dust and waterproof to IP 65 rating.

Features & Benefits:

- CAT6 performance – fast data transmission and high bandwidth applications
- CAT6 specifications according TIA / EIA 568B, ISO / IEC 11801, EN 50173
- Shielded system - high noise immunity and EMI protection
- Push Pull mating - secure and proven locking system
- D-shape metal panel connector
- Ground lead jumper on panel connector with selectable grounding option
- IDC termination without tool
- Ready made patch cables with rugged cable carrier and unique chuck-type strain relief
- Dust and waterproof according IP 65

Technical Data

Electrical	Receptacle		Patch cable		Materials	Receptacle		Patch cable	
	Receptacle	Patch cable	Receptacle	Patch cable		Receptacle	Patch cable	Receptacle	Patch cable
Number of contacts:	8	8	8	8	Housing:	Zinc diecast	Zinc diecast	Zinc diecast	Zinc diecast
Rated current per contact:	1.5 A	1.5 A	1.5 A	1.5 A	Adapter:	Polyamide PA 6	Polyamide PA 6	Polyamide PA 6	Polyamide PA 6
TIA / EIA rating:	CAT6	CAT6	CAT6	CAT6	Strain relief clamp:	-	POM	-	POM
Input to output resistance:	< 200 mΩ	< 200 mΩ	< 200 mΩ	< 200 mΩ	Contacts:	Bronze CuSn	Bronze CuSn	Bronze CuSn	Bronze CuSn
Insulation resistance:	> 500 MΩ	> 500 MΩ	> 500 MΩ	> 500 MΩ	Contact surface:	Gold	Gold	Gold	Gold
Dielectric strength:	1 kV dc	1 kV dc	1 kV dc	1 kV dc	Bushing:	-	PU /PA	-	PU /PA
NEXT (250 MHz):	48.7 dB	48.7 dB	48.7 dB	48.7 dB					
Attenuation (250 MHz):	0.1 dB	0.1 dB	0.1 dB	0.1 dB					

Mechanical

Retention method:	Push-Pull	Operating temperature:	-10°C to +60°C
Life time (mating cycles):	> 1'000	Storage temperature:	-40°C to +70°C
Wire size:	0.5 - 0.65 mm (AWG 24 - AWG 22)	Flammability:	UL94HB
Stranded wire:	AWG 26 / 7 - 22 / 7	Protection class:	IP 65

Environmental

Ordering Information

Patch Cable

NKE6S-*	Standard lengths: 0.5, 1, 3, 5, 10 m
NKE6S-*-WOC	Equipped on one side with metal shell, standard lengths: 0.5, 1, 3, 5, 10 m Custom length in meter steps on request.

Receptacle

NE8FDY-C6	EtherCon CAT6 with Nickel D-shell
NE8FDY-C6-B	EtherCon CAT6 with Black Chrome D-shell



USB and Firewire Adapter



D-shape metal housing



USB type B



D-shape metal housing



IEE 1394 receptacle

USB



NAUSB

- Ideal for audio networking and integration of computer-based equipment into audio systems
- USB gender changer type A-B (B-A)
- Reversible insert offering type A or B on front or rear end
- Universally accepted standard D-shape housing

Firewire



NA1394-6-B

- Ideal for audio networking and integration of digital equipment into audio systems
- Firewire feedthrough with 6-pole IEEE 1394 receptacle at both ends
- Universally accepted standard D-shape housing

NAUSB



NA1394-6



Technical Data

Mechanical		USB	Firewire
Insertion / withdrawal force	< 35 N / > 10 N	•	•
Lifetime	> 1'500 cycles	•	•
Electrical			
Rated current	1.5 A	•	•
Contact resistance	< 30 mΩ (mated pair)	•	•
Insulation resistance		> 1 GΩ	> 100 MΩ
Dielectric withstanding voltage	500 V ac (1 min)	•	•
Rated voltage		< 30 V ac	< 40 V dc
Material			
Shell	Zinc diecast (ZnAl4Cu1)	Nickel or black Chrome	•
Insert / Insulation		Polyamid PA 6	•
Contacts		Brass (CuZn39Pb3)	-
Contact finish		Gold	•
Shell finish		Nickel	•
Environmental			
Operating temperature	-25°C to +85°C	•	•
Flammability	UL94 V-0	•	•

Ordering Information

USB

NAUSB	USB A – USB B Adapter (reversible), Nickel housing
NAUSB-B	USB A – USB B Adapter (reversible), black housing

Firewire

NA 1394-6	6-pole Firewire Adapter (IEEE 1394), Nickel housing
NA 1394-6-B	6-pole Firewire Adapter (IEEE 1394), black housing

Accessories



DSS-*



SCM



SCDX

DSS-*	Lettering plate for D series, coloured plastic
SCM	Plastic sealing cover to protect the Firewire connectors against dust and moisture.
SCDX	Hinged cover seals D-size chassis connectors, IP42 rated

*: 0 - Black, 1 - Brown, 2 - Red, 3 - Orange, 4 - Yellow, 5 - Green, 6 - Blue, 7 - Violet, 8 - Grey, 9 - White



BNC Connectors

Content

Page

Rear Twist Cable Connectors.....	83	Connector to Cable Guide	90
Push Pull Cable Connectors.....	85	Chassis Connectors	92
Accessories	87	Technical Data	93
Cable to Connector Guide	88		

NEUTRIK® 75 Ω BNC Connectors

Neutrik® offers a variety of 75 Ω cable and chassis BNC connectors. The Push-Pull and RearTwist® cable connectors are easy to handle in high density applications such as video patchbays and switches, provide a tactile and fast assembly and offer colour coding as a standard. All parts of our BNC series are precisely machined to our high quality standards.

True 75 Ω HDTV Connectors

With the introduction of HD signals the impedance of BNC connectors becomes more important than ever. Every deviate impedance has a negative influence on the „return loss“ / „VSWR“ (Voltage Standing Wave Ratio) which are important measurements for reflected signals in a transmission line. Especially on high frequencies - as they occur when transmitting HD signals (typical transmission @ 2.25 GHz) - an impedance mismatch results in a lot of return loss.

Neutrik's BNC connectors feature a true 75 Ω design that meet the stringent requirements of HDTV and sustain a consistent impedance at high frequencies up to 3 GHz. To achieve this result every Neutrik® BNC connector has been adapted to the measurements of a small group of cables, this guarantees the best possible performance and a little return loss.



The higher the frequencies the more pronounced is the „skin effect“, which means that the energy moves to the outside of the conductor. Therefore the plating of outer and center contact is more important than on audio connectors with low frequencies - both contacts of our BNC connectors are gold plated.

Neutrik BNC's - enhanced high frequency shielding!

In times of rising frequencies the connector shielding becomes to an important value in order to avoid EMI problems and crosstalking. Neutrik BNC's take this fact into account and has been equipped with an optimized ground contact design for maximum shielding effectiveness.

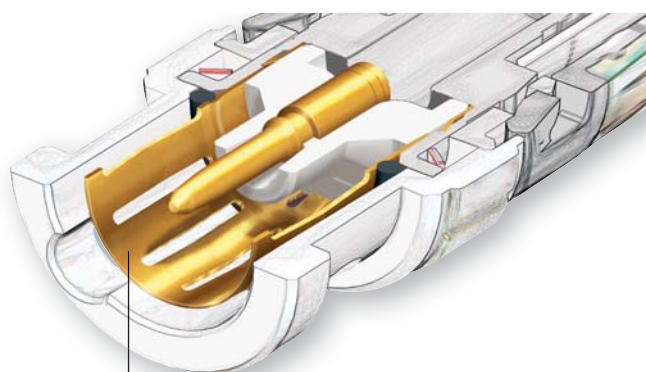
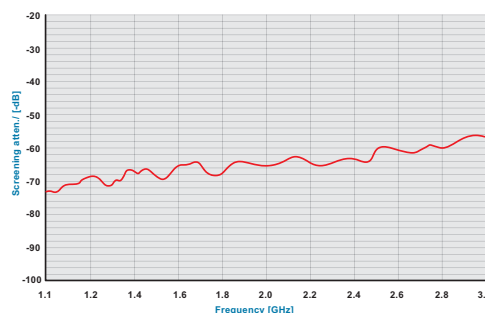

Gold plated ground contact with improved shielding effectiveness optimized for high frequency HDTV signal up to 3 GHz.

Rear Twist Cable Connectors



Bayonet locking



Gold plated contacts



Female cable jack

Rear Twist® (Standard, Large & Tiny) and Cable Jacks



NBTC75BLI4



NBNC75BLP7



NBNB75GLP9



NBTB75CFI4

- "Rear Twist® Principle" locking/unlocking using the easily accessible soft touch boot (Patent DE 100 48507)
- Ideal for recessed bulkheads where access to the "head" of the connector might be an issue. These connectors turn from the back and not the front.
- True 75 Ω design meets the stringent HDTV / DVD requirements
- Snug-fit center pin insert provides tactile feedback
- Shield and jacket crimp technology prevents the problem of an exposed grounding braid on cable assemblies
- Excellent cable protection and retention
- Large version for RG 11 cable
- Precise Swiss machined brass parts for outstanding durability
- Accessories include color coded boots in 10 standard colours, crimp tool and dies
- Sleek female cable jack e.g. for Y-cables
- Mountable panel version of cable jack for fixed installations



Features & Benefits

- Screen and cable jacket crimp instead of screen crimp only.
Grooved inner surface holds the cable jacket to prevent tearing braids.

- Gold plated ground contact with improved shielding effectiveness optimized for high frequency HDTV signal up to 3 GHz.



- Rear Twist® boot in 10 colours for easy access in high density applications.

- Leading area: Avoids tilting due to side forces to protect the contacts from deformation. Guarantees a lifetime of min. 1'000 mating cycles!



Neutrik BNC:
no tilting due to side pull



Other BNC



Push Pull locking



Gold plated contacts

Push Pull Cable Connectors



NBNC75PTS11



NBNC75PNS7



NBNC75PIE9



NBNC75PLS9

- Unique Push-Pull locking system is ideal for ultra high density applications, patching, etc.
- True 75 Ω design meets the stringent HDTV / DVD requirements
- Excellent return loss / VSWR data
- Precision machined parts
- Assembly is fast and easy and requires only a standard center contact crimp after cable preparation
- Reusable due to screw lock strain relief
- Snug-fit center pin insert provides tactile feedback
- Only pin crimp, this eliminates the need of different crimp dies and facilitates field repair
- Innovative screw lock cable retention for easy assembly
- Accessories include colour coded boots in 10 standard and 3 translucent colours



Features & Benefits

- Push Pull sleeve in various colours for easy access in high density applications.
- Neutrik® chuck type strain relief offers flexibility and field repair.
- Gold plated ground contact with improved shielding effectiveness optimized for high frequency HDTV signal up to 3 GHz.
- Leading area: Avoids tilting due to side forces to protect the contacts from deformation. Guarantees a lifetime of min. 1'000 mating cycles!
- Push Pull locking mechanism for convenient handling, perfect for patching applications.



Accessories



BNC tool case equipped with
 - HX-R-BNC
 - PT-BNC: Plier tool
 - CS-BNC: Stripping tool

CAS-BNC-T

Note: Dies have to be ordered separately.

Crimp tool, frame



HX-R-BNC

Crimp tool die for pin and shield for HX-R-BNC



DIE-R-BNC-*

Boots, tools, ...



BST-BNC-*

Standard boot for the Rear Twist® BNCs in black, 9 different colours available.



BS-BNC-*

Boot for Push-Pull BNCs in black, 9 different colours available, as well as 3 translucent variants.



HX-BNC

Crimp tool, frame. (heavy duty)



DIE-BNC-*

Crimp tool die for pin and shield for HX-BNC.



HT-BNC

Spanner tool for the Push-Pull BNCs.



DSS

Lettering plate for D Shape bulkheads.



SCF

Rubber sealing cover to protect the connector against dust and moisture



SCDX

Hinged cover seals D-size chassis connectors, IP42 rated

Crimp die assignment for HX-BNC

Crimp die	Hex crimp mm		Hex crimp inch		Center pin mm (square crimp)
	A	B	A	B	
DIE-BNC-CS	4.06	7.01	0.160	0.276	1.6
DIE-BNC-JD	5.41	4.53	0.213	0.178	1.6
DIE-BNC-PG	6.47	5.00	0.255	0.197	1.6
DIE-BNC-U	7.36	-	0.290	-	1.6
DIE-BNC-UG	7.36	5.00	0.290	0.197	1.6
DIE-BNC-Y	8.23	-	0.324	-	1.6

Crimp die assignment for HX-R-BNC

Crimp die	Hex crimp mm			Hex crimp inch			Center pin mm (square crimp)
	A	B	C	A	B	C	
DIE-R-BNC-PDC	6.47	4.53	4.06	0.255	0.178	0.160	1.6
DIE-R-BNC-PG	6.47	5.00	-	0.255	0.197	-	1.6
DIE-R-BNC-PJ	6.47	5.41	-	0.255	0.213	-	1.6
DIE-R-BNC-PS	6.47	7.01	-	0.255	0.276	-	1.6
DIE-R-BNC-PU	6.47	7.36	-	0.255	0.290	-	1.6
DIE-R-BNC-PY	6.47	8.23	-	0.255	0.324	-	1.6
DIE-R-BNC-Z	9.73	-	-	0.383	-	-	1.75 (Hex crimp)

Cable to Connector Guide

	Push Pull	Rear Twist	Rear Twist Tiny	Cable Jack Tiny	Cable Jack Panel	Hex Crimp in mm
Belden						
1277R, 1278R, 1279R			NBTC75BNN5			4.53
1406B, 1407B, 1417B			NBTC75BVV5			5.00
1426A	NBNC75PLS9	NBNC75BLP9			NBNB75GLP9	6.47
1505A (ANH)	NBNC75PLS9	NBNC75BLP9			NBNB75GLP9	6.47
1505F	NBNC75PLS9	NBNC75BJP9				6.47
1506A	NBNC75PIE9	NBNC75BIJ9				5.41
1520A, 1521A, 1522A, 179DT			NBTC75BFI4	NBTB75CFI4		4.06
1694A (ANH)	NBNC75PTS11	NBNC75BTU11				7.36
1694F	NBNC75PTS11	NBNC75BTY11				8.23
1695A	NBNC75PQS11	NBNC75BQP11				6.47
1855A	NBNC75PDE6	NBNC75BDD6				4.53
1865A			NBTC75BXX6			5.00
1855ENH	NBNC75PFE7	NBNC75BFG7				5.00
7731A (ANH)		NBLC75BVZ17				9.73
8218			NBTC75BXX5			5.00
8241	NBNC75PNS7	NBNC75BLP7				6.47
8241F	NBNC75PLS9	NBNC75BLP9			NBNB75GLP9	6.47
8281		NBNC75BXY9				8.23
8281F		NBNC75BYY9				8.23
9221			NBTC75BLI4			4.06
CANARE						
L-4CFB	NBNC75PLS9	NBNC75BLP9			NBNB75GLP9	6.47
L-5CFB		NBNC75BYY11				8.23
LV-61S	NBNC75PNS7	NBNC75BLP7				6.47
LV-77S		NBNC75BYY9				8.23
V(3-5)-3C	NBNC75PGE7	NBNC75BGG7				5.00
V(3-5)-4CFB	NBNC75PLE9	NBNC75BJJ9				5.41
V(3-5)-5C	NBNC75PVS9	NBNC75BRS9				7.01
V(3-5)-5CFB	NBNC75PVS11	NBNC75BWS11				7.01
L-1.5C2VS			NBTC75BLI4			4.06
COMMSCOPE						
2065V	NBNC75PIE9	NBNC75BIJ9				5.41
2279V	NBNC75PQS11	NBNC75BQP11				6.47
5563	NBNC75PNS7	NBNC75BLP7				6.47
5565	NBNC75PLS9	NBNC75BLP9			NBNB75GLP9	6.47
5765	NBNC75PTS11	NBNC75BTU11				7.36
7536 (03-05)			NBTC75BXX6			5.00
7538	NBNC75PDE6	NBNC75BDD6				4.53
CANFORD						
SDV, SDM	NBNC75PFE7	NBNC75BFG7				5.00
SDV-L, SDV-F	NBNC75PVS11	NBNC75BWS11				7.01
SDV-HD		NBLC75BVZ17				9.73
SDV-F-HD		NBNC75BWU13				7.36
DRAKA MULTIMEDIA CABLE						
0.31 / 1.45 AF, 753-1304(2), 755-1302			NBTC75BFI4	NBTB75CFI4		4.06
0.41 / 1.9 AF, 753-1104, 755-1103, 755-1101			NBTC75BNN5	NBTB75CNN5		4.53
0.51 / 2.3 Dz, 757-1001, VADN 7243		NBTC75BVX6				5.00
0.6 / 2.8 AF, 0.6 L / 2.8 AF	NBNC75PFE7	NBNC75BFG7				5.00
0.6 / 3.7, 0.6L / 3.7	NBNC75PNS7	NBNC75BLP7				6.47
0.6 / 3.7 Dz	NBNC75PNS7	NBNC75BLS7				7.01
0.8 / 3.7 AF, 755-801(803, 804)	NBNC75PLS9	NBNC75BLP9			NBNB75GLP9	6.47
0.8 / 4.9 Dz		NBNC75BXY9				8.23
1.0 / 4.8 AF, 755-901/5	NBNB75PTS11	NBNC75BUU11			NBNB75GUU11	7.36
1.2L / 4.8Dz, 1.2L / 4.95AF		NBNC75BWU13				7.36
1.4 / 6.6 AF		NBLC75BSX14				9.73
1.6 / 7.3AF		NBLC75BVZ17				9.73



Cable to Connector Guide

	Push Pull	Rear Twist	Rear Twist Tiny	Cable Jack Tiny	Cable Jack Panel	Hex Crimp in mm
GEPCO						
VPM2000	NBNC75PLS9	NBNC75BLP9			NBNB75GLP9	6.47
VSD2001	NBNC75PTS11	NBNC75BTU11				7.36
SUHNER						
G02233			NBTC75BFI4	NBTB75CFI4		4.06
G04233D	NBNC75PNS7	NBNC75BLS7				7.01
S02223			NBTC75BLI4			4.06
S04233, S04263	NBNC75PLS9	NBNC75BLP9			NBNB75GLP9	6.47
S05133-07	NBNC75PTS11	NBNC75BTU11				7.36
S05163-02	NBNC75PTS11	NBNC75BTU11				7.36
OTHERS						
AT&T 735			NBTC75BSS5			4.53
COMM-TEC RGBHV			NBTC75BSS5			4.53
Argosy (Dranka) Image 360		NBNC75BFG7				5.00
Argosy (Dranka) Image 720		NBNC75BLP9				6.47
Argosy (Dranka) Image 1000	NBNC75PTS11	NBNC75BUU11			NBNB75GUU11	7.36
BBC PSF 1/3*	NBNC75PNS7	NBNC75BLS7				7.01
BESCA France - Bengat			NBTC75BNS4			4.53
CAE MC75			NBTC75BLI5	NBTB75CLI5		4.06
CAE MC75.39			NBTC75BVX6			5.00
CAE KX6A	NBNC75PNS7	NBNC75BLP7				6.47
CAE VCB75	NBNC75PNS9	NBNC75BNP9				6.47
CAE VCB 100		NBNC75BXU13				7.36
Cordial CVI 3-7	NBNC75PFE7	NBNC75BFG7				4.53
Cordial CVI 06-28	NBNC75PFE7	NBNC75BFG7				5.00
Cordial CVI (CVM) 06-37	NBNC75PNS7	NBNC75BLP7				6.47
COVID CVD 1300-1500			NBTC75BLI5	NBTB75CLI5		4.06
Eupen 705 CRT 5V-HS	NBNC75PTS11	NBNC75BTS11				7.36
Extron BNC-5HR			NBTC75BNN5	NBTB75CNN5		4.53
Extron BNC-5RC	NBNC75PGE7	NBNC75BFG7				5.00
Helix 734	NBNC75PNS9	NBNC75BNP9				6.47
Helix 735			NBTC75BSS5			4.53
Hirschmann KOKA 712Cu	NBNC75PTS9	NBNC75BTS9				6.47
Kansai 0.5M3C-2V	NBNC75PGE7					-
Kansai 3C-5S	NBNC75PFE6	NBNC75BFH6				5.00
KLOTZ						
V06/28, VMXx75Y	NBNC75PFE7	NBNC75BFG7				5.00
V06/37	NBNC75PNS7	NBNC75BLP7				6.47
V10/48	NBNC75PTS11	NBNC75BUU11			NBNB75GUU11	7.36
V16/72		NBLC75BVZ17				9.73
KROSCHU (341 270, 341 280)			NBTC75BLI4			4.06
Nexans						
HF 75 0.6/2.9 02YS(ST)CH		NBNC75BFG7				5.00
HF 75 1.6/7.2 02Y(ST)C(ST)H		NBNC75BVZ17				9.73
HF 75 0.6/3.7 2YCY		NBNC75BLP7				6.47
RG11		NBLC75BVZ17				9.73
RG59B/U	NBNC75PNS7	NBNC75BLP7				6.47
RG179B/U			NBTC75BLI4			4.06
SOMMER						
600-0051 (M/L/S)	NBNC75PNS7	NBNC75BLP7				6.47
600-0054 (M/L/S)	NBNC75PNS7	NBNC75BLP7				6.47
600-0101M	NBNC75PFE7	NBNC75BFG7				5.00
600-0104M	NBNC75PFE7	NBNC75BFG7				5.00
600-162(F)	NBNC75PLS9	NBNC75BLP9				6.47
600-025* -03 (05)			NBTC75BLI5	NBTB75CLI5		4.06
600-0701			NBTC75BLI5	NBTB75CLI5		4.06
600-020* -03 (05)			NBTC75BLI5	NBTB75CLI5		4.06
600-0451	NBNC75PLS9	NBNC75BLP9			NBNB75GLP9	6.47
600-0751			NBTC75BVX6			5.00
Wisi MK 99A	NBNC75PVS12	NBNC75BWS12				7.01
ZNK CM14B			NBTC75BFI4	NBTB75CFI4		4.06

* Registered trademark of BBC

Connector to Cable Guide

	Pin crimp mm (square)	Hex crimp mm	Inner Conductor	Insulator	Cable O.D.
PUSH PULL					
NBNC75PDE6	1.6	N/A	< 0.6	< 2.65	4.0 - 5.0
NBNC75PFE6	1.6	N/A	< 0.6	< 2.85	4.0 - 5.0
NBNC75PFE7	1.6	N/A	< 0.7	< 2.85	4.0 - 5.0
NBNC75PGE7	1.6	N/A	< 0.7	< 3.2	4.0 - 5.0
NBNC75PIE9	1.6	N/A	< 0.9	< 3.5	4.0 - 5.0
NBNC75PLE9	1.6	N/A	< 0.9	< 3.65	4.0 - 5.0
NBNC75PLS9	1.6	N/A	< 0.9	< 3.65	6.0 - 7.0
NBNC75PNS7	1.6	N/A	< 0.7	< 3.75	6.0 - 7.0
NBNC75PNS9	1.6	N/A	< 0.9	< 3.75	6.0 - 7.0
NBNC75PQS11	1.6	N/A	< 1.1	< 4.3	6.0 - 7.0
NBNC75PTS9	1.6	N/A	< 0.9	< 4.6	6.0 - 7.0
NBNC75PTS11	1.6	N/A	< 1.1	< 4.6	6.0 - 7.0
NBNC75PVS9	1.6	N/A	< 0.9	< 4.9	6.0 - 7.0
NBNC75PVS11	1.6	N/A	< 1.1	< 4.9	6.0 - 7.0
NBNC75PVS12	1.6	N/A	< 1.2	< 4.9	6.0 - 7.0
REAR TWIST					
NBLC75BVZ17	1.75 (Hex crimp)	9.73	< 1.7	< 8.0	< 10.4
NBLC75BSX14	1.75 (Hex crimp)	9.73	< 1.4	< 6.6	< 9.5
NBNC75BDD6	1.6	4.53	< 0.6	< 2.8	< 4.3
NBNC75BFG7	1.6	5.00	< 0.7	< 3.1	< 4.7
NBNC75BFH6	1.6	5.00	< 0.6	< 3.1	< 4.9
NBNC75BGG7	1.6	5.00	< 0.7	< 3.2	< 4.7
NBNC75BIJ9	1.6	5.41	< 0.9	< 3.6	< 5.3
NBNC75BIJ9	1.6	5.41	< 0.9	< 3.8	< 5.3
NBNC75BJP9	1.6	6.47	< 0.9	< 3.8	< 6.3
NBNC75BLP7	1.6	6.47	< 0.7	< 3.8	< 6.3
NBNC75BLP9	1.6	6.47	< 0.9	< 3.8	< 6.3
NBNC75BLS7	1.6	7.01	< 0.7	< 3.8	< 6.9
NBNC75BNP9	1.6	6.47	< 0.9	< 4.1	< 6.3
NBNC75BQP11	1.6	6.47	< 1.1	< 4.5	< 6.3
NBNC75BRS9	1.6	7.01	< 0.9	< 4.8	< 6.9
NBNC75BTS9	1.6	7.01	< 0.9	< 4.7	< 6.9
NBNC75BTS11	1.6	7.01	< 1.1	< 4.7	< 6.9
NBNC75BTU11	1.6	7.36	< 1.1	< 4.7	< 7.3
NBNC75BUU11	1.6	7.36	< 1.1	< 4.7	< 7.3
NBNC75BTY11	1.6	8.23	< 1.1	< 4.7	< 8.0
NBNC75BWS11	1.6	7.01	< 1.1	< 5.1	< 6.9
NBNC75BWS12	1.6	7.01	< 1.2	< 5.1	< 6.9
NBNC75BWU13	1.6	7.36	< 1.4	< 5.1	< 7.3
NBNC75BXU13	1.6	7.36	< 1.4	< 5.1	< 7.3
NBNC75BXY9	1.6	8.23	< 0.9	< 5.1	< 8.0
NBNC75BYY9	1.6	8.23	< 0.9	< 5.2	< 8.0
NBNC75BYY11	1.6	8.23	< 1.1	< 5.2	< 8.0
REAR TWIST TINY					
NBTC75BFI4	1.6	4.06	< 0.4	< 1.6	< 2.9
NBTC75BLI4	1.6	4.06	< 0.4	< 1.8	< 2.9
NBTC75BLI5	1.6	4.06	< 0.5	< 1.8	< 2.9
NBTC75BNN5	1.6	4.53	< 0.5	< 2.0	< 3.1
NBTC75BNS4	1.6	4.53	< 0.4	< 2.0	< 3.5
NBTC75BSS5	1.6	4.53	< 0.5	< 2.3	< 3.4
NBTC75BVV5	1.6	5.00	< 0.5	< 2.5	< 3.8
NBTC75BVX6	1.6	5.00	< 0.6	< 2.5	< 4.0
NBTC75BXX5	1.6	5.00	< 0.5	< 2.6	< 4.0
NBTC75BXX6	1.6	5.00	< 0.6	< 2.6	< 4.0
CABLE JACKS (TINY & PANEL VERSION)					
NBTB75CFI4	1.6	4.06	< 0.4	< 1.6	< 2.9
NBTB75CNS5	1.6	4.53	< 0.5	< 2.0	< 3.1
NBTB75CLI5	1.6	4.06	< 0.5	< 1.8	< 2.9
NBNB75GLP9	1.6	6.47	< 0.9	< 3.8	< 6.3
NBNB75GUU11	1.6	7.36	< 1.1	< 4.9	< 7.3
NBNB75ILP9	1.6	6.47	< 0.9	< 3.8	< 6.3
NBNB75IUU11	1.6	7.36	< 1.1	< 4.9	< 7.3



Cable Type

Belden 1855A; CommScope 7538
 Kansai 3C-5S
 Belden 1855ENH; Cordial CVI 06-28, CVI 3-7; Canford SDM, SDV-LFH; Draka 0.6/2.8 AF, 0.6L/2.8 AF; Sommer 600-0101M, 600-0104M, KLOTZ V06/28, VMXx75Y
 Canare V(3-5)-3C; Extron BNC-5RC
 Belden 1506A; CommScope 2065V
 Canare V(3-5)-4CFB
 Belden 1505A (ANH), Belden 1505F; 8241F; CommScope 5565; Canare L-4CFB; Draka 0.8/3.7 AF, 755-801 (803,804); Gepco VPM2000; Suhner S04263; Sommer 600-0451, 600-162(F), 804
 Belden 8241; BBC PSF 1/3, CAE KX6A; CommScope 5563; Cordial CVI (CVM) 06-37; Suhner G04233D; Canare LV-61S; RG59B/U; Draka 0.6/3.7, 0.6/3.7 Dz, 0.6L/3.7;
 Sommer 600-0051 (M,L,S), 600-0054 (M,L,S), KLOTZ V06/37
 CAE VCB75; Helix 734
 Belden 1695A; CommScope 2279V
 Hirschmann KOKA 712Cu
 Belden 1694A (ANH), 1694F; CommScope 5765; Draka 1.0/4.8 AF, 755-901/5, Argosy (Draka) Image 1000; Eupen 705 CRT 5V-HS; Gepco VSD2001; Suhner S05133-07 S05163-02, KLOTZ V10/48
 Canare V(3-5)-5C
 Canare V(3-5)-5CFB; Canford SDV-F, SDV-L
 Wisi MK 99A

Belden 7731A (ANH); Canford SDV-HD; Draka 1.6/7.3AF; KLOTZ V16/72; RG11; Nextans HF 75 1.6/7.2 02Y(ST)C(ST)H
 Draka 1.4 / 6.6 AF
 Belden 1855A; CommScope 7538
 Argosy (Draka) Image 360; Belden 1855ENH; Canford SDM, SDV-S-LFH; Cordial CVI 06-28, CVI 3-7; Draka 0.6/2.8 AF, 0.6L/2.8 AF; Extron BNC-5RC;
 Sommer 600-0101M, 600-0104M, KLOTZ V06/28, VMXx75Y; Nexans HF 75 0.6/2.9 02YS(ST)CH
 Kansai 3C-5S
 Canare V(3-5)-3C
 Belden 1506A; CommScope 2065V
 Canare V(3-5)-4CFB
 Belden 1505F
 Belden 8241; CAE KX6A; Canare LV-61S; Cordial CVI (CVM) 06-37; CommScope 5563; Draka 0.6/3.7, 0.6L/3.7 ; RG59B/U; Sommer 600-0051 (M,L,S), 600-0054 (M,L,S),
 KLOTZ V06/37; Nextans HF 75 0.6/3.7 2YCY
 Argosy (Draka) Image 720; Belden 1505A (ANH), 8241F; Canare L-4CFB; CommScope 5565; Draka 0.8/3.7 AF, 755-801 (803, 804); Gepco VPM2000; Suhner S0426;
 Sommer 600-0451, 600-162(F)
 BBC PSF 1/3; Draka 0.6/3.7 Dz, 755-801 (803, 804); Suhner G04233D (PTT 6010)
 CAE VCB75; Helix 734
 Belden 1695A; CommScope 2279V
 Canare V(3-5)-5C
 Hirschmann KOKA 712Cu
 Eupen 705 CRT 5V-HS
 Belden 1694A (ANH); CommScope 5765; Gepco VSD2001; Suhner S05163-02, 05133-07
 Belden 1694A; CommScope 5765; Gepco VSD2001; Suhner S05163-02, 05133-07; Argosy (Draka) Image 1000
 Belden 1694F
 Canare V(3-5)-5CFB; Canford SDV-L, SDV-F
 Wisi MK 99A
 Canford SDV-F-HD; Draka 1.2L/4.8Dz, 1.2L/4.95AF
 CAE VCB 100
 Belden 8281; Draka 0.8/4.9Dz
 Belden 8281F; Canare LV-77S
 Canare L-5CFB

Belden 1520A, 1521A, 1522A, 179DT; Draka 0.31/1.45 AF, 753-1304(2), 755-1302; Suhner G02233, ZNK CM14B
 Canare L-1.5C2VS; Suhner S02223; Kroschu (341 270, 341 280); RG 179 B/U; Sommer 600-025-03 (05)
 CAE MC75; Procom; Sommer 600-0701, 600-20-03 (05), 600-025-03 (05)
 Belden 1277R, 1278R, 1279R; Draka 0.41/1.9AF, 753-1104, 755-1103; Extron BNC-5 HR(P) (Bulk), BNC-5RC
 TESCA France - Bengat
 AT&T 735; CommTech RGBHV
 Belden 1406B, 1407B, 1417B
 CAE NC75.39; Draka 755-1001 (0.51/2.3Dz), 757-1001; Sommer 600-0751; VADN 7243
 Belden 8218
 Belden 1865A; CommScope 7536

Belden 1520A, 1521A, 1522A, 179DT; Draka 0.31/1.45 AF, 753-1304(2), 755-1302; Suhner G02233; ZNK CM14B
 Draka 0.41/1.9 AF, 753-1104, 755-1101; 755-1103; Extron BNC 5 HR(P) (Bulk)
 CAE MC75; Sommer 600-0701, 600-20-03 (05), 600-025-03 (05)
 Belden 1505A, 8241F; Canare L-4CFB; CommScope 5565; Draka 0.8/3.7 AF, 755-801 (803, 804); Gepco VPM2000; Suhner S04263; Sommer 600-0451
 Draka 1.0/4.8AF, 755-901/5, Argosy (Draka) Image 1000, KLOTZ V10/48
 Belden 1505A, 8241F; Canare L-4CFB; CommScope 5565; Draka 0.8/3.7 AF, 755-801 (803, 804); Gepco VPM2000; Suhner S04263; Sommer 600-0451
 Draka 1.0/4.8AF, 755-901/5, Argosy (Draka) Image 1000, KLOTZ V10/48



D-shape metal housing



Gold plated center pin

Bulkhead Jacks



NBB75FI



NBB75DFG



NBB75DFGB



NBB75SI

- True 75 Ω design meets the stringent HDTV / DVD requirements
- Isolated or grounded versions
- "D" shaped housing (provides flush mounting and protection of the jacks from damage) or single feed through mountings
- Gold plated center contact

NBB75DFG

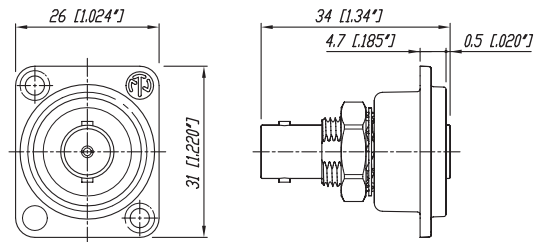

NBB75FI

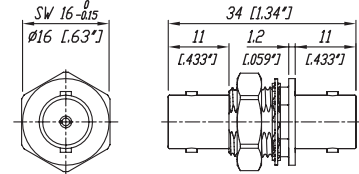

Ordering Information

	Nickel housing	Black housing
Bulkhead jack, D-shape housing, feed through, grounded	NBB75DFG	NBB75DFGB
Bulkhead jack, D-shape housing, feed through, isolated	NBB75DFI	NBB75DFIB
Bulkhead jack, D-shape housing, solder version, grounded	NBB75DSG	NBB75DSGB
Bulkhead jack, D-shape housing, solder version, isolated	NBB75DSI	NBB75DSIB
Bulkhead jack, feed through, grounded	NBB75FG	
Bulkhead jack, feed through, isolated	NBB75FI	
Bulkhead jack, solder version, including isolation washers	NBB75SI	



Technical Specifications

Specifications		Rear Twist® & Rear Twist Large & Cable Jack Panel	Rear Twist® Tiny & Cable Jack Tiny	Push Pull	Bulkheads
----------------	--	---	------------------------------------	-----------	-----------

Electrical

Impedance	75 Ω	•	•	•	•
Rated voltage	500 V ac rms	•	250 V ac rms	•	•
Insulation resistance	> 5 GΩ	•	•	•	•
Dielectric withstanding voltage	1500 V ac rms	•	750 V ac rms	•	•
VSWR / Return Loss	≤ 1.050 / > 32 dB up to 1 GHz	•	≤ 1.10 / > 26 dB up to 1 GHz	•	≤ 1.03 / > 37 dB up to 1 GHz
	≤ 1.065 / > 30 dB up to 2 GHz	•	≤ 1.14 / > 24 dB up to 2 GHz	•	≤ 1.05 / > 32 dB up to 2 GHz
	≤ 1.100 / > 26 dB up to 3 GHz	•	≤ 1.22 / > 20 dB up to 3 GHz	•	≤ 1.08 / > 28 dB up to 3 GHz
Inner contact resistance	≤ 3 mΩ (initial)	•	•	•	•
Outer contact resistance	≤ 2 mΩ (initial)	•	•	•	•

Mechanical

Cable anchoring	Jacket crimping	•	•	Neutrik® chuck principle	N / A
Cable O.D. range - Rear Twist Large	mm	4.0 - 7.7 10.3	2.5 - 3.8 -	4.0 - 8.0 -	N / A -
	Center contact retention	> 30 N	•	•	-
Engagement force	< 25 N	•	•	< 20 N	•
Lifetime	1'000 mating cycles	•	•	•	•

Environmental

Temperature range	-30°C to +85°C	•	•	-30°C to +40°C	•
Solderability	Complies with IEC 68-2-20	•	•	•	N / A
Contact crimpability	Complies with IEC 60803 and IEC 60352-2	•	•	•	N / A

Materials

Shell: Brass (CuZn39Pb3), OPTALLOY coated	•	•	•	•
PA6 (Push Pull only)	N / A	N / A	•	N / A
D-Shape housing: Zinc diecast (ZnAl4Cu1) gal Ni or black Cr plating	N / A	N / A	N / A	•
Ground contact:				
Bronze (CuSn6), 0.2 μm AuCo over 2 μm NiP15	•	•	•	-
Brass (CuZn39Pb3), OPTALLOY coated	-	-	-	•
Center contact:				
Brass (CuZn35Pb2), 0.2 μm AuCo or	•	•	•	-
Brass (CuZn39Pb3), 0.2 μm AuCo	-	-	-	•
Insulator: Teflon PTFE	•	•	•	•
Chuck: Polyacetal POM	N / A	N / A	•	N / A
Insulation Shell: Polyacetal POM	N / A	N / A	N / A	•

Center Contact:

I.D. in mm	Materials	Plating	Coding Ring (# of rings on base of contact)
0.4	Brass (CuZn39Pb3)	2 μm AuCo	0
0.5	•	•	5
0.6	•	•	1
0.7	•	•	2
0.9	•	•	3
1.1	•	•	6
1.2	•	•	4
1.7	•	•	0

Production

The professional entertainment industry depends on reliable components - night in, night out. Neutrik® - the world's leading manufacturer of professional connector systems - sets the standards in technical reliability, warranty and durability. Availability of products as well as technical support and

excellent service are to be understood as priority objectives. Besides cutting-edge precision, functionality and design make the difference and build the basis for our complex demand for high quality standards.

To realize our innovative product ideas and to meet the requirements of our customers we make use of all possibilities which modern R&D and production technologies can offer. Neutrik has developed and proven its own automated manufacturing methods. The professional mechanics of the automation department work with state-of-the-art technologies like video control systems and robotics.

Together with the systematic quality control the high precision robotic production processes ensures continuous quality and efficient delivery of goods to the right place at the right time.





Circular Connectors

Content	Page
PowerCon® Series	97
PowerCon® 32 Amp Series	99
NanoCon® Series	100
MiniCon Series	102
Neutricon® Series	104
Technical Data	106
Assembly Tools	107

Introduction

The Neutrik® circular connector program is a range of metal, multi-pole connectors specifically designed for industrial applications. These series provide a variety of male and female cable connectors and receptacles that can be terminated by soldering and crimping or to printed circuit boards. An easy to use and reliable quick-lock system ensures a perfect connection and cannot be released accidentally. The circular connectors offer Neutrik® unique chuck type strain relief and reinforced housing for robust dependability.

The Neutrik® industrial connector range also features a unique power connector for single phase applications up to 32 Amps.

Further features are:

- Number of contacts is 1 to 12
- Self-locking system
- Robust all-metal housing
- Front or rear mounting
- Chuck and crimp type strain relief
- Gold plated contacts
- Solder or crimp termination
- Printed circuit board mounting
- Excellent shielding (crimp type strain relief)

The main areas of applications are in the measurement, test and control, automotive and machine tool industry as well as medical technique.



New quick lock



Neutrik hologramm

PowerCon® - Locking 3 Pole Power Connectors

NEW



NAC3FCA



NAC3MPA

NEW



NAC3FCB



NAC3MPB

- Lockable 3 pole equipment (AC) connector with contacts for line, neutral and pre-mating safety ground
- High current capacity, rated at 20A / 250V ac.
Colour coded for easy identification, PowerCon® offers power-in (blue) and power-out (grey) versions with different keying to avoid the possibility of intermating
- Fast and easy locking system
- Extremely robust and reliable
- Excellent cable retention
- UL, cUL recognized components (file no. E 135070)
VDE certified (Reg. No. 6360),
SEV approved (No. 96.1 10096)
- New latch design for easier handling and secure locking
- Branded with unique hologram - guarantees genuine and authentic Neutrik product

NAC3FCA(B)

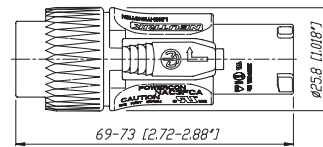

NAC3MPA(B)

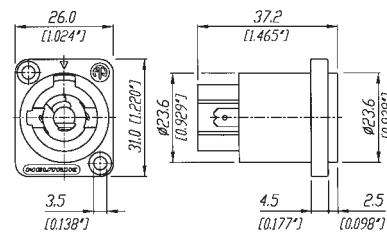

NAC3MM

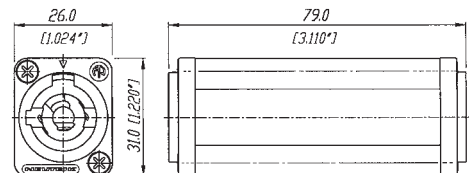

Ordering Information

NAC3FCA	Cable connector, quick lock with securing lever, A-type for power inlet, screw terminals
NAC3MPA	Air tight chassis connector, A-type for power inlet, flat tab terminals
NAC3FCB	Cable connector, quick lock with securing lever, B-type for power outlet, screw terminals
NAC3MPB	Air tight chassis connector, B-type for power outlet, flat tab terminals
NAC3MM	Coupler for linking cables (couples NAC3FCA to NAC3FCB)

Accessories



NDL	Dummy plug for PowerCon 20 A chassis connector
NLFASTON	FASTON® receptacle for tabs with "positiv lock" for use with NL4MP, NL4MPR, NL8MPR, Pack of 100 pcs.
SCL	Plastic sealing cover to protect the connectors against dust and moisture
SCDR	Rear end protection cover for D-size chassis connectors
SCDX	Hinged cover seals D-size chassis connectors, IP42 rated

Accessories

With the two non-interchangeable types of connectors (A type and B type) it is impossible to produce a short circuit. Mating connectors (combination) are identified by mechanical keyways and by color.



ATTENTION

The technical data of the PowerCon® connectors refer to connectors without breaking capacity, meaning connecting devices not to be engaged and disengaged in normal use when live or under load.



Robust metal housing



Screw-type terminals

PowerCon® 32 Amp Connectors



NAC3FC-HC



NAC3MP-HC

- Locking single phase AC appliance coupler
- High current capacity (32 A rated)
- Fast and easy locking system
- Excellent cable handling and protection
- Extremely robust and reliable
- 250 V ac, 32 Amp single-phase (for ambient temperatures up to 35°C)
- Premating contact for protective earth
- Locking system to prevent unintentional disengagement
- Cable O.D. Range: 8 - 20 mm
- Wiring with screw-type terminals for wires 2.5 to 6.0 mm² (AWG 14 - 10)

NAC3FC-HC



NAC3MP-HC





Connector locking



PCB receptacle

NanoCon® - 3 Pole Subminiature Connectors



NP3F-H



NSC3F



NR3M-S

- World's smallest circular lockable multipole connector
- Robust metal housing with gold plated contacts
- Male and female receptacles for vertical or horizontal PCB mount or solder termination
- Cable connector and receptacle with interchangeable male and female inserts
- Reliable and versatile in applications like medical equipment, control systems, sensors or audio applications such as miniature and wireless microphones and portable mixers
- Pre-mating contact 1

NSC3F(M)

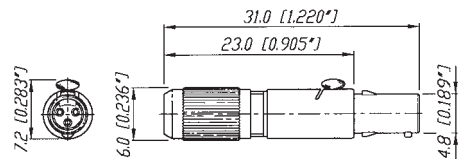

NR3F(M)-S

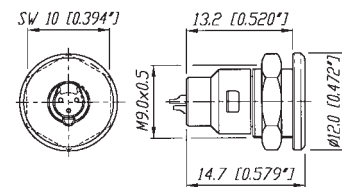

NP3F(M)-H

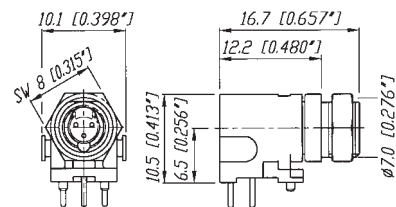

M 1:1



Ordering Information

Female		Male	
NSC3F	Cable connector, chuck principle, solder contacts	NSC3M	Cable connector, chuck principle, solder contacts
NR3F-S	Receptacle panel mount, solder contacts	NR3M-S	Receptacle panel mount, solder contacts
NP3F-H	Receptacle horizontal PCB mount	NP3M-H	Receptacle horizontal PCB mount
NP3F-V	Receptacle vertical PCB mount	NP3M-V	Receptacle vertical PCB mount



NP3F-H
NP3M-H



NP3F-V
NP3M-V

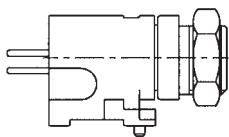

NR3F-S

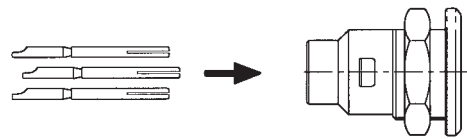

NR3M-S

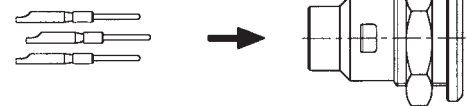

Contact Arrangement

male



female





Push Pull locking



Gold solder contacts

MiniCon - 12 Pole Miniature Connectors



MSCM12



MRF12



MMC* (modular system)

- Up to 12 pole miniature connector
- Complete set or modular system
- Push-pull self-locking system
- Precisely machined, rugged all metal design
- Fully loaded male and female receptacles for horizontal or vertical PCB mount
- Gold plated contacts, crimp or solder
- Special crimp type strain relief establishes an ideal coaxial connection of the cable shield to the connector shell for best EMC shielding

MPF(M)12-V



MRF(M)12

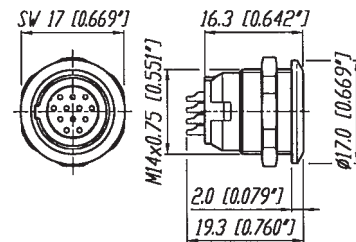

MSCF(M)12 (+MSRC)

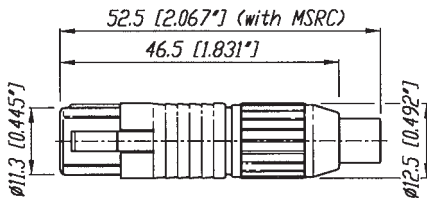

MPF(M)12-H

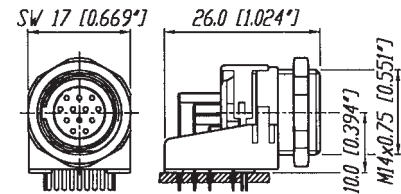

Ordering Information for complete MiniCon set

Complete set (consisting of housing, insert, 12 contacts and chuck for cable connector)

Female		Male	
MSCF12	Cable connector, chuck principle, solder contacts	MSCM12	Cable connector, chuck principle, solder contacts
MRF12	Receptacle panel mount, solder contacts	MRM12	Receptacle panel mount, solder contacts
MPF12-H	Receptacle horizontal PCB mount	MPM12-H	Receptacle horizontal PCB mount
MPF12-V	Receptacle vertical PCB mount	MPM12-V	Receptacle vertical PCB mount

MSCF(M)12



MPF(M)12-V



MPF(M)12-H



Ordering Information for modular MiniCon system



Modular system

Female		Male	
MFI	Insert for cable connector	MMI	Insert for cable connector
MBC	Crimp contacts for cable connector and receptacle	MPC	Crimp contacts for cable connector and receptacle
MBS	Solder contacts for cable connector and receptacle	MPS	Solder contacts for cable connector and receptacle
MRF	Receptacle housing and insert pre-assembled	MRM	Receptacle housing and insert pre-assembled
MMC	Cable connector extension, incl. chuck (for male and female)		
MSC	Cable connector housing, incl. chuck (for male and female)		
MSRC	Set of strain relief crimp version (tools see page 107, crimp ferrule & reduction ferrule 1 + 2)		



Push Pull locking



All metal housing

Neutricon® - Versatile Circular Connectors



ORP8F-Ni



OSC8F



ORP8M

- Complete set or modular system for any desirable configuration
- Contact configuration can be selected from 1 to 8 contacts
- Special crimp type strain relief establishes an ideal circumferential connection of the cable shield to the connector shell as required by best EMC working practice
- Precise and robust all metal housing absorbs vibration forces and protects contact inserts
- Easy, fast and screwless assembly
- Push-pull self-locking system

OSC8F / OSC8M

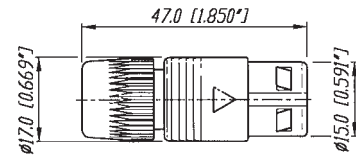

MODULAR SYSTEM



MC8 + SR8A/B + insert

Polarization

Housing: Two variants of metal polarizing guides (90° and 180°).

Coding 90°



Coding 180°



Insert: The male and female insert can be assembled in all three housings.

ORP8F / ORP8M

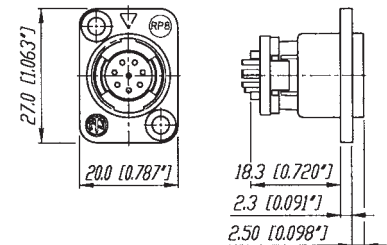

Ordering Information for complete Neutricon set

Complete set (consisting of housing, insert, 8 contacts and chuck for cable connector)

OSC8F	Female cable connector, chuck principle, black housing, solder contacts
OSC8F-Ni	Female cable connector, chuck principle, nickel housing, solder contacts
OSC8M	Male cable connector, chuck principle, black housing, solder contacts
OSC8M-Ni	Male cable connector, chuck principle, nickel housing, solder contacts
ORP8F	Female panel mount receptacle, black housing, solder contacts
ORP8F-Ni	Female panel mount receptacle, nickel housing, solder contacts
ORP8M	Male panel mount receptacle, black housing, solder contacts
ORP8M-Ni	Male panel mount receptacle, nickel housing, solder contacts

Ordering Information for modular Neutricon system

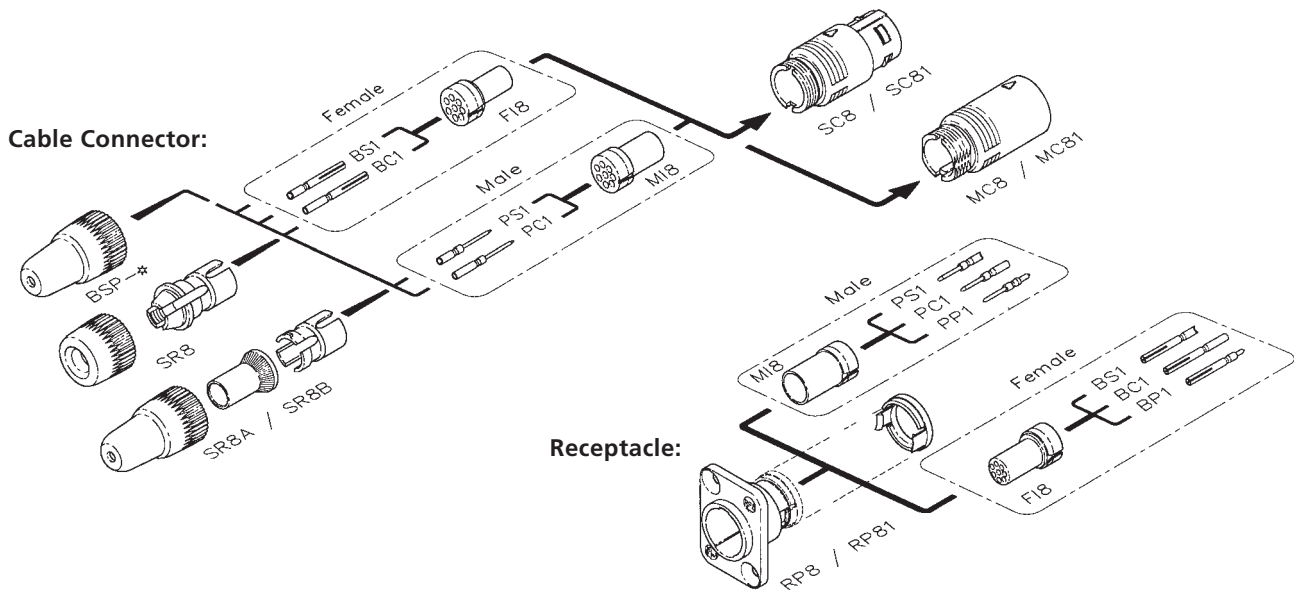

Modular system

Female		Male	
FI8	Insert for cable connector and receptacle	MI8	Insert for cable connector and receptacle
BS1	Solder contact	PS1	Solder contact
BC1	Crimp contact	PC1	Crimp contact
BP1	PCB contact	PP1	PCB contact
SC8	Cable housing, black coated, 180° coding	MC8	Mating cable housing, black coated, 180° coding
SC8-Ni	Cable housing, nickel coated, 180° coding	MC8-Ni	Mating cable housing, nickel coated, 180° coding
SC81	Cable housing, black coated, 90° coding	MC81	Mating cable housing, black coated, 90° coding
SC81-Ni	Cable housing, nickel coated, 90° coding	MC81-Ni	Mating cable housing, nickel coated, 90° coding
SC8W	Cable housing, black coated, 180° coding, waterproof multipin connector according IP54		
RP8	Receptacle, black coated, 180° coding		
RP8-Ni	Receptacle, nickel coated, 180° coding		
RP81	Receptacle, black coated, 90° coding		
RP81-Ni	Receptacle, nickel coated, 90° coding		
SR8	Bushing and chuck type strain relief (standard)		
SR8A	Crimp type strain relief for cable O.D. 3 - 3.8 mm (Hex crimp 5.41 mm acc. IEC 803, see also page 15)		
SR8B	Crimp type strain relief for cable O.D. 6 - 7 mm (Hex crimp 7.01 mm acc. IEC 803, see also page 15)		
SR8W	Bushing and chuck type strain relief for waterproof solution IP54		
BSP-*	Coloured boot, available in 10 resistor colours		

* color coding: 0 - Black, 1 - Brown, 2 - Red, 3 - Orange, 4 - Yellow, 5 - Green, 6 - Blue, 7 - Violet, 8 - Grey, 9 - White

Specification	PowerCon® Series	32 A PowerCon® Series	NanoCon® Series	MiniCon® Series	NeutriCon® Series
---------------	------------------	-----------------------	-----------------	-----------------	-------------------

Electrical

Number of contacts:	2 + PE	2 + PE	3	12 (1-12 modular system)	8 (1-8 modular system)
Rated current per contact:	20 A rms	32 A rms	2 A	3 A	7.5 A (solder), 5 A (crimp)
Rated voltage:	250 V ac	250 V ac	50 V ac	50 V ac	50 V ac
Dielectric strength:	4000 V dc	4000 V dc	1000 V dc	1000 V dc	1500 Vdc
Contact resistance:	≤ 3 mΩ	≤ 3 mΩ	≤ 12 mΩ	≤ 8 mΩ	≤ 5 mΩ
Insulation resistance after damp heat test (IEC 68-2-30):	> 100 MΩ	> 100 MΩ	> 1 GΩ	> 500 MΩ	> 500 MΩ

Mechanical

Retention method:	Quick lock	Quick lock	latch	Push-pull	Push-pull
Cable O.D. range:	5 - 15 mm	8 - 20 mm	3.4 mm max.	3 - 5 mm (grey chuck) 5 - 7 mm (white chuck) 2.5 - 6 mm (crimp version MSRC)	3 - 7 mm 3 - 3.8 mm (SR8A) 6 - 7 mm (SR8B)
Wiring:	Cable: screw type terminals or soldering 2.5 mm ² / 14 AWG	screw type terminals 2.5-6 mm ² / 14-10 AWG	0.2 mm ² / 24 AWG for solid wire	0.5 mm ² / 20 AWG for solder	1.0 mm ² / 18 AWG for solder
	Chassis: flat tabs for FASTON®		0.14 mm ² 26 AWG for stranded wire	0.22 mm ² 24 AWG for crimp	0.14 - 0.34 mm ² 22 - 26 AWG for crimp
Solderability complies with IEC 68-2-20:	•	•	•	•	•

Material

Housing cable connector:	PA 6 30% GR	PA 6 30% GR	CuSn4Pb4Zn4	ZnAl4Cu1 / CuZn39Pb3	ZnAl4Cu1 gal Ni or black chrome
Housing receptacle:	PA 6 30% GR	PA 6.6 25% GR	CuZn39Pb2	ZnAl4Cu1	ZnAl4Cu1, gal Ni or black chrome
Insert:	PA 6 30% GR	PA 6.6 25% GR	PETP	PA 6.6	PBTP 15% GR
Contacts:	CuZn39Pb3 / CuSn6	CuZn39Pb3 / CuSn0.2	CuZn35Pb2	CuZn35Pb2 (solder) CuZn39Pb3 (crimp) CuSn6	CuZn35Pb2 (solder) CuZn39Pb3 (crimp)
Contact surface:	4 μm / 20 μm Ag plated	4 μm Ag	0.5 μm Au	0.2 μm AuCo	0.3 μm Au hard alloy over 2 μm Ni
Chuck POM:	•	•	•	•	•

Environmental

Flammability UL 94 HB:	•	• plug housing	UL 94 V-0	UL 94 V-0	•
Flammability UL 94 V-0:	-	• socket housing + plug insert	-	-	-
Temperature range: -30°C to +80°C	•	•	•	•	•
Protection class (mated):	IP 20	IP 2X unmated	IP 40	IP 5X	IP5X
Safety Requirements EN/IC61984:	•	•	-	-	-

FASTON® is a trademark of AMP Inc.

Crimptool

Crimptool HX-CONTACT



DMC crimping tool AFM8
acc. M22520/2-01



MPOS-*



Modified DMC positioner (K155)
Contact positioner holds contact in
position when crimping.

Contact and connector assembly

Crimptool HX-R-BNC



Neutrik® HEX crimping tool



DIE-R-BNC-*



Neutrik® DIE's for various HEX sizes.

Neutricon® - Ordering Information Assembly Tools

		Cable O.D. / Wire	Crimptool	Die/Positioner	HEX-Size/Standard
SR8A	Strain relief	3 - 3.8 mm	HX-R-BNC	DIE-R-BNC-PJ	5.41 mm / IEC 803
SR8B	Strain relief	6 - 7 mm	HX-R-BNC	DIE-R-BNC-PS	7.01 mm / IEC 803
BC1	Female crimp contact	AWG 22 -26	HX-CONTACT	MPOS-BC1	No. 5 / M22520/2-01
PC1	Male crimp contact	AWG 22 -26	HX-CONTACT	MPOS-PC1	No. 5 / M22520/2-01

MiniCon® - Ordering Information Assembly Tools

		Cable O.D. / Wire	Crimptool	Die/Positioner	HEX-Size/Standard
MSRC	Crimp ferrule only	4.5 - 6 mm	HX-R-BNC	DIE-R-BNC-PDC*	6.47 mm / IEC 803
MSRC	Crimp ferrule & reduction ferrule 1	3.3 - 4.4 mm	HX-R-BNC	DIE-R-BNC-PDC*	6.47 mm / IEC 803
MSRC	Crimp ferrule & reduction ferrule 2	2.5 - 3.2 mm	HX-R-BNC	DIE-R-BNC-PDC*	6.47 mm / IEC 803
MBC	Female crimp contact	24 AWG/0.22 mm ²	HX-CONTACT	MPOS-MBC	No. 5 / M22520/2-01
MPC	Male crimp contact	24 AWG/0.22 mm ²	HX-CONTACT	MPOS-MPC	No. 5 / M22520/2-01

* DIE-R-BNC-PJ or PS also possible



Accessories

Content	Page
Circular Adapters	111
D Shape Adapters	112
Ordering Information	113
AES / EBU Digital Impedance Transformer Adapters	114
DMX Adapters	115
Feedthrough	115
Modules & Audio Transformers	116
Ordering Information	117
Goosenecks	118

NEUTRIK® ACCESSORIES

Various connector standards in the professional and semi-professional audio and video world lead constantly to interconnection problems.

Neutrik® made it as a rule to serve the customers' needs in all connector belongings and offers therefore a variety of problem solvers.

With our adapter series we have a solution for the most known interconnection difficulties and on top of this we offer modules of the most common connector types to fulfil specific needs beyond that.

Miniature balancing adapters are the answer to known noise and grounding problems and for customized designs we recommend our proven audio transformers in combination with our modules.

All our adapters and connectors are soldered with lead free ROHS compliant solder.

Neutrik® is proud of being ROHS compliant with all our products and on top of this we became „Sony Green Partner“ already in the year 2003.

Adapter



XLR connector



RCA phono socket



Jack with locking latch



BNC socket

Circular Adapters



NA2FP



NA2MPMM



NA3MJ



NA4FC-F

- Versatile, pre-wired and ready to use adapters to reliably interlock various connector systems
- Professional look and compact space saving design, based on the X Series (XLR worldwide accepted standard)
- Rugged diecast shell for best reliability

NA3FP



NA3FM



NA3FJ



NA2FBNC



Example drawing. Find more info on www.neutrik.com

Adapter



Phono socket



Speakon NL4MP



3 pole XLR male



Jack with locking latch

D Shape Adapters



NA2BBNC-D9B



NA2M-D2B-TX



NA4MP-J



NA4MP-MX

- Problem solvers for various intermating problems for professional and semi-professional applications
- Rugged aluminium extrusion housings for best reliability
- Colour coding on all RCA types

Miniature transformer balancing adapters NA2*-TX

- Audio Transformer 1:1 impedance ratio 200 : 200
- Low cost solution for unbalanced / balanced line conversion and passive DI applications, where no earth or gain switching is required.
- Source / Load impedance 600 / 10K
Max. input level @ 50Hz at 1% THD: -3dBu



NA2F-D0B-TX

NA2BBNC-D9B



NA4MP-J

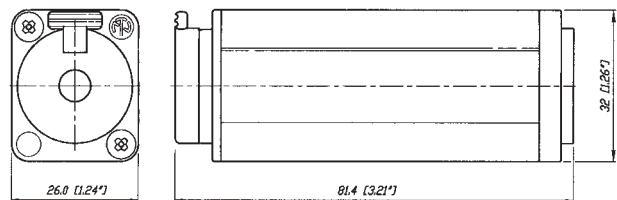

Example drawing. Find more info on www.neutrik.com

Circular Adapters

Part No.	Port 1	Port 2	Comments
NA2FBNC	3 pole XLR female	BNC socket	1)
NA2FP	3 pole XLR female	TS ²⁾ , 1/4" plug	1)
NA2FPMF	3 pole XLR female	RCA / phono socket	1)
NA2FPMM	3 pole XLR female	RCA / phono plug	1)
NA2MBNC	3 pole XLR male	BNC socket	1)
NA2MP	3 pole XLR male	TS ²⁾ , 1/4" plug	1)
NA2MPMF	3 pole XLR male	RCA / phono socket	1)
NA2MPMM	3 pole XLR male	RCA / phono plug	1)
NA3FF	3 pole XLR female	3 pole XLR female	gender conversion adapter
NA3FF-B	3 pole XLR female	3 pole XLR female	gender conversion, black plating
NA3FJ	3 pole XLR female	TRS ²⁾ , 1/4" jack	locking jack
NA3FM	3 pole XLR female	3 pole XLR male	extension adapter
NA3FMX	3 pole XLR female	3 pole XLR male	contacts 2 - 3 inverted
NA3FP	3 pole XLR female	TRS ²⁾ , 1/4" plug	
NA3JJ	stereo 1/4" jack	TRS ²⁾ , 1/4" jack	extension adapter, locking jack
NA3MJ	3 pole XLR male	TRS ²⁾ , 1/4" jack	locking jack
NA3MM	3 pole XLR male	3 pole XLR male	gender conversion adapter
NA3MM-B	3 pole XLR male	3 pole XLR male	gender conversion, black plating
NA3MP	3 pole XLR male	TRS ²⁾ , 1/4" plug	
NA4FC-F	Speakon® NL4FC	3 pole XLR female	speaker adapter ³⁾
NA4FC-M	Speakon® NL4FC	3 pole XLR male	speaker adapter ³⁾
NA4LJX	Speakon® NL4FX	TS ²⁾ , 1/4" jack	speaker adapter ³⁾
NA4MP-F	Speakon® NL4MP	3 pole XLR female	speaker adapter ³⁾
NA4MP-J	Speakon® NL4MP	TS ²⁾ , 1/4" jack	speaker adapter ³⁾
NA4MP-M	Speakon® NL4MP	3 pole XLR male	speaker adapter ³⁾
NA4MP-M-X	Speakon® NL4MP	Speakon® NL4MP	speaker adapter 1+ / 1- inverted ³⁾
NA5FF-B	5 pole XLR female	5 pole XLR female	gender conversion adapter, black plating
NA5MM-B	5 pole XLR male	5 pole XLR male	gender conversion adapter, black plating

D Shape Adapters

NA2BBNC-D4B	BNC socket	RCA / phono socket	colour coded yellow
NA2BBNC-D9B	BNC socket	RCA / phono socket	colour coded white
NA2F-D0B-TX	3 pole XLR female	RCA / phono socket	colour coded black ⁴⁾
NA2F-D2B-TX	3 pole XLR female	RCA / phono socket	colour coded red ⁴⁾
NA2F-J-TX	3 pole XLR female	1/4" jack	ground lifted ⁴⁾
NA2M-D0B-TX	3 pole XLR male	RCA / phono socket	colour coded black ⁴⁾
NA2M-D2B-TX	3 pole XLR male	RCA / phono socket	colour coded red ⁴⁾
NA2M-J-TX	3 pole XLR male	1/4" jack	ground lifted ⁴⁾
NE8FF	EtherCon®	EtherCon®	RJ45 coupler
NL4MMX	4 pole Speakon®	4 pole Speakon®	lockable coupler
NL8MM	8 pole Speakon®	8 pole Speakon®	lockable coupler

1) ... Wired according to IEC 268-12: pin 2 = signal, pin 1 and 3: connected to ground

2) ... TRS-Tip, Ring, Sleeve contact (stereo); TS-Tip, Sleeve contact (mono)

3) ... Detailed wiring info on www.neutrik.com

4) ... Unbalanced / balanced line conversion, 1:1 transformer 200 Ω : 200 Ω

Adapter



3 pole XLR female receptacle



3 pole cable connector



BNC chassis

AES / EBU Digital Impedance Transformer Adapters



NADITBNC-F



NADITBNC-FX



NADITBNC-MX

- Allow long cable runs for digital audio signals via low attenuation coax lines
- Match balanced to coaxial lines
- Match impedances 110 Ω to 75 Ω
- Simple use, passive units

NADITBNC-FX



Technical Data

Maximum voltage / Max. power:	5 Vp-p / 250mW
Frequency band:	0.1 MHz to 6 MHz
Insertion loss:	< 0.3 dB @ 0.1 MHz to 10 MHz
VSWR / Return loss:	< 1.1 / > 26.4 dB



NADITBNC-F

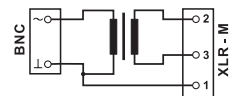

NADITBNC-M

Ordering Information

Part No.	Port 1	Port 2	Comments
	Input	Output	
NADITBNC-F	3 pole XLR female chassis	female BNC chassis	110 Ω XLR input and 75 Ω BNC output
NADITBNC-M	3 pole XLR male chassis	female BNC chassis	75 Ω BNC input and 110 Ω XLR output
NADITBNC-FX	3 pole XLR female cable con.	female BNC chassis	110 Ω XLR input and 75 Ω BNC output
NADITBNC-MX	3 pole XLR male cable con.	female BNC chassis	75 Ω BNC input and 110 Ω XLR output

Adapter



5 pole male connector



5 pole female connector



All metal housing

DMX Adapters

Feedthrough



NA3F5M



NA3F5M

NEW



NA3FDM



NA3MDF

- Compact XLR 3 to 5 pole adapters for lighting (DMX) applications
- Solve interconnection problems of the old (3-pole) and new (5-pole) DMX standard
- Enable usage of standard 3-pole microphone cable for DMX applications
- Based on the worldwide accepted standard XLR connectors
- Reliable and rugged diecast shell

- 3-pole XLR feedthrough adapter
- D-flange chassis mount
- Male to female and vice versa
- Utilizes XX-components



NA3F5M

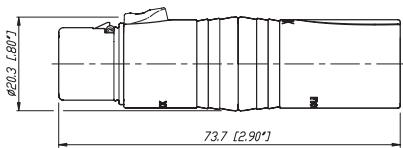

NA3MDF

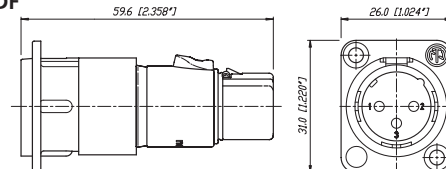

NA3FDM

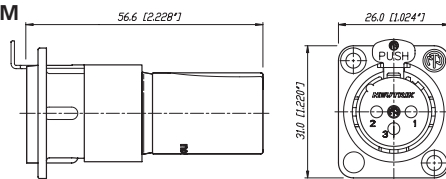

Ordering Information DMX Adapter

Part No.	Port 1	Port 2	Comments
NA3F5M	3 pole XLR female	5 pole XLR male	for DMX lighting applications
NA3M5F	3 pole XLR male	5 pole XLR female	for DMX lighting applications

Ordering Information Feedthrough

NA3FDM	3 pole XLR female	3 pole XLR male
NA3MDF	3 pole XLR male	3 pole XLR female



3 pole plug



SM2/2 switch



VM housing

Modules & Audio Transformers



NM3FXI



NM3P



KMX



SM2/2



NM3FD-B

- Multifunctional modules allow to design customized adapters to suit specific needs
- Based on the X Series connector system
- NTE transformers and switch can be built in
- Professional look, rugged diecast shell

Audio Transformer

- Professional audio transformers for multiple applications, as e.g. microphone or line inputs
- Very low distortion, excellent frequency response
- Cost effective cable version for free wiring
- Fully permalloy-shielded studio versions



NTE10-3



NTL1

Audio Transformer selection Guide

Part No.	Turns Ratio (prim : sec)	Impedance ratio	Source / load impedance in Ω	Max. Input level* @ 50 Hz, 1% THD [dBu]	Applications
NTE1	1 : 1	200 : 200	200 / 2k, (600 / 10k)	-3	General purpose, splitting, XLR inline
NTE4	1 : 4	200 : 3.2k	200 / 10 K	-7	Mic input step-up
NTE10/3	1 : 3	200 : 1.8k	200 / 10 K	-7	General purpose mic input step-up
	1 : 10	200 : 20k	200 / 50 K	-6	
NTL1	1 : 1	10k : 10k	600 / 10k	+19	Line input
NTM1	1 : 1	200 : 200	200 / 2k	+7	Mic input, splitting
NTM4	1 : 4	200 : 3.2k	200 / 10k	+9	Mic input step-up

* measured with typical source / load impedances

Wiring: NTE*... free wires, NTL / NTM*... PCB mount, shielded; Find detailed specifications on www.neutrik.com



Module Selection Guide

Connector module	Coupler / housing	Transformer / switch
NM3FXI XLR female M17x1 outside 	KM M 17x1 inside 	NTE1 1:1 
NM3MXI XLR male M17x1 outside 	KMX M 17x1 inside 	NTE4 1:4 
NM2P mono 1/4" plug M17x1 inside 	VM M 17x1 outside 	NTE10/3 1:3:10 
NM3P stereo 1/4" plug M17x1 inside 	VMX M 17x1 outside 	SM2/2 2x2 switch M17x1 outside 
NM3J stereo 1/4" jack M17x1 inside 	CM cable outlet M 17x1 inside 	
NMPMM RCA male M17x1 inside 	NA-Housing ¹⁾ black plated screws included 	
NMPMF RCA female M17x1 inside 		
NM3FD-B black plated D-Shape 		
NM3MD-B black plated D-Shape 		

1) ... Combinations possible with all D Shape connectors like e.g. NC3FD-L-1, NF2D, NBB75DSI, etc.

Example:





NM3FXI



KM



NTE1



SM2/2



KMX



NM3MXI

Goosenecks



3 pole XLR with securing ring



Flexible spiral



Integrated cable outlet

Goosenecks



GN18



GN36



GN50

- For flexible and secure mounting of microphones, lamps etc.
- Versatile, modular system allows various combinations
- Durable stainless steel spiral, no rust, no noise, non-reflective black finish
- Theft proof microphone connection on GNS version (securing ring and fixing screw)

Ordering Information

Part No.	Description
GN18	M17x1 inside thread at both ends (Ø 12 mm, 230 mm length)
GN36	M17x1 inside thread at both ends (Ø 13 mm, 360 mm length)
GN50	M17x1 inside thread at both ends (Ø 15 mm, 500 mm length)
Gooseneck sets:	
GNS18	Gooseneck set GN18, NC3FX-Spec., cable outlet, NAM5 adapter, M17x1 bolt thread
GNS36	Gooseneck set GN16, NC3FX-Spec., cable outlet, NAM5 adapter, M17x1 bolt thread
GNS50	Gooseneck set GN50, NC3FX-Spec., cable outlet, NAM5 adapter, M17x1 bolt thread
Accessories:	
NAM4	M17x1 outside thread, 5/8" 27 UNS inside thread ¹⁾
NAM5	3/8" inside thread, 5/8" 27 UNS outside thread ¹⁾
GF1	Panel-mounting kit: Flange Ø 63.5 mm including mounting bolt M17x1, 30 mm length ¹⁾
MSG	Mounting bolt M17x1, 30 mm length ¹⁾
¹⁾ ... Find detailed specifications on www.neutrik.com	

GNS Set consisting of:

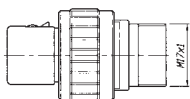

NC3FX-Spec

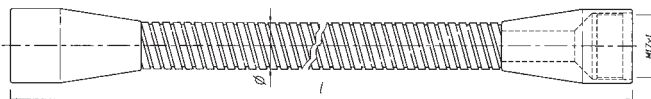

GN



Cable outlet



NAM5

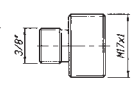

M17x1 bolt



Patch Panels

Content	Page
NPPA-Series - 96 Bantam (TT) Jacks	121
NPP-TB-Series - 48 B-Gauge Jacks	123
1/4" Patch Panel	125
MA 96 and XPM 96 Bantam Patchbays	127
LF 48 B-Gauge Patchbays	129
Technical Data	131
Ordering Information	132

Introduction

Patch Panels are central switching gears between audio equipments. They are used to switch and route analog and digital audio signals from and to equipments in recording or broadcast studios, OB vans, churches, theatres, stadiums, arenas, etc.

Neutrik® Patch Panels are available in a variety of jack types, wiring and grounding possibilities. Common versions accommodating Bantam TT, 1/4" A-gauge and longframe B-gauge jacks on the front rows are available. The mechanical size is designed to fit into 1U 19" standard racks. All Neutrik Patch Panels offer various normalling possibilities between top and bottom row.

All Neutrik® Patch Panels are able to handle digital audio signals acc. AES3, 48kHz sampling rate.

Audio Normalling

Audio Normalling is usually used with audio patch panels and is a wiring pattern in which a circuit path is established from one piece of audio equipment to another without the use of a patch cord. This pattern is then considered to be the „normal“ circuit path that is desired most of the time. If a patch cord is inserted, the normal circuit path is interrupted and rerouted to a different circuit path.

Normalled patch panels are most commonly found in vertical jack pairs: the top jack is designated as the source and the bottom jack is the destination.

Normalling example: HALF NORMALLED BOTTOM ROW

This is the most common configuration, very often called HALF NORMALLED. In this configuration internal normalling contacts

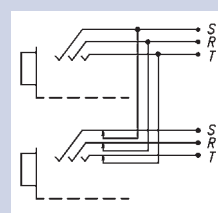

connect the top jack contact with the corresponding bottom jack contact. Inserting a plug in the bottom jack will interrupt this internal normalling connection, while inserting a patch cord into the top jack doesn't interrupt the circuit. (Can be used to monitor the normalling circuit)

Other versions of normalling are Half Normalled Top Row, Full Normalled, Parallel and Isolated.

" Easy Patch " Patch Panel



Robust front design



Easy assembly



Jack-pair



IDC terminals



Push terminals



ELCO connectors

NPPA-Series - 96 Bantam (TT) Jacks



NPPA-TT-PT

- Innovative and compact patching system (just 1U high) for 19" rack mounting
- Robustly housed in a black coated steel shell
- New high quality long life gold plated Neutrik® prewired double jacks with drastically improved contact integrity
- Available in all common normalling configurations (default HNB)
- Qualified for analog and digital signals acc. AES 3, 48 kHz sampling frequency
- Different choices of wiring

Dimensional Drawing



Design Criteria

All panels are fitted with high quality, long life Neutrik® NJ3TTA gold plated double contact jacks (2 x 48), featuring drastically improved contact integrity and are available with a wide choice of wiring terminations. The unit is finished off with a built in cable bar and two large channel ident strips for perfect management of the system.

The new generation of the Neutrik® "Easy-Patch" is easily programmable for any one of five configurations (standard is half normalised bottom row) and for the grounding system of your choice. Each individual pair of jacks can be changed

or reconfigured quickly and without fuss even while the panel is "on air". The NJ3TTA jacks offer also two contact points per terminal (TRS) with a special designed mechanism for the normalling contact. Simply remove the front panel to reveal the easy access jack. Remove, replace or reconfigure the jack and refix the panel.

The "Easy-Patch" is an innovative and compact patching system (just 1U high) for 19" rack mounting. Robustly housed in a black coated steel shell and featuring precision aluminium fittings it is built to last.

Configuration

The standard version of the NPPA Panel is delivered bottom row half normalised for each jack pair by default. Further patch versions are available with fully loaded jack-pairs as:

- Full Normalled
- Half Normalled
- Isolated
- Parallel

For individual normalling single pre-configured jack-pairs are offered.

NPPA-TT-IDC is equipped with jumper blocks for individual switching configurations of each jack channel.

Note: Take care when handling digital signals. Do not use parallel configuration and avoid other parallel paths when using half normalised configurations. Parallel paths may lead to mismatching.

Half Normalled Bottom



Half Normalled Top



Full Normalled

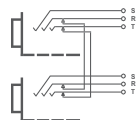

Parallel

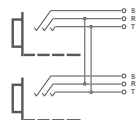

Isolated

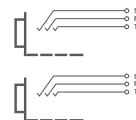

Grounding

The flexible grounding system provides the following versions:

- Individual: Each channel is individually grounded by its corresponding cable shield (default configuration).
- Group: Selected channel grounds are connected via the ground bus on the PCB using solder bridges and track cuts to form a group that is connected to one common cable shield.
- Central: All channel grounds (individual top and bottom row) are connected via the ground bus on the PCB using solder bridges and wired with only one cable shield.
- Chassis-Common: The same as central grounding but with the addition of the common ground bus (top and / or bottom rows) connected to the patch panel chassis by means of jumpers

Wiring Terminations

TT Patch Panels offer different choices of wiring:

- Spring loaded push terminals
- 56 pin Elco/Edac male connectors
- 90 pin Elco/Edac connectors
- 50 pin D-SUB connectors
- 25 pin D-SUB connectors
- IDC-Krone terminals
- Solder lugs

The spring loaded terminal blocks enable fast and easy wiring. No soldering and screwing necessary. Simply insert the stripped wire after pressing down the white key. Terminals accommodate stranded wires up to AWG 20 (0.5 mm²) and solid wires up to AWG 18 (0.75 mm²). Push terminals are gas tight connections.

For Pin assignment of ELCO / EDAC and D-SUB connectors please refer to website.

" Easy Patch " Patch Panel



Individual colour coding



Galvanized metal housing

NPP-TB-Series - 48 B-Gauge Jacks



NPP-TB-HN



NPP-TB + NPP-LB*

- Features 2 x 24 Neutrik® NJ6TB-V long frame 1/4" TRS jacks according to BPO 316 / MIL-P-641/3
- Very robust and compact galvanized metal housing
- Eye catching channel identification through coloured snap-on coding tabs
- Six easily programmable switching configurations
- Qualified for analog and digital signals acc. AES 3, 48 kHz sampling frequency
- With high quality long life gold plated Neutrik® jacks

Dimensional Drawing

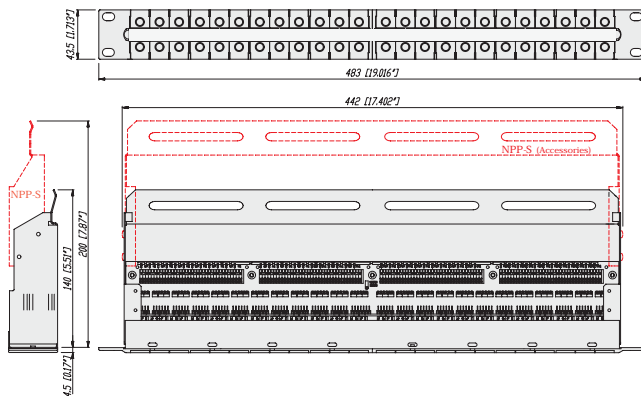

Design Criteria

The TB Patch Panel is a very robust and compactly designed Patch Panel for 19" rack mount (19" x 1U) with galvanized metal housing, a built-in cable bar on the rear for securing wires. There is a rear extension bar (NPP-S) available as an option for some panel types. On the front side we have an attractive additional lettering facility for each channel pair with a marking strip and individual snap-on colour coding plates.

The NPP is easily programmable for six switching configurations and for changing the flexible grounding system. All panels have the high quality long life gold plated Neutrik® NJ6TB-V Jack for the BPO / MIL style plugs. We have two variants of rear connection. The standard is equipped with spring loaded terminals strips and an optional version offers solder lugs.

Configuration

Due to the jumper blocks capability provided, the switching configurations available per jack channel are:

- Half Normalled Bottom Row
- Full Normalled
- Parallel
- Isolated

The TB Panel is delivered in a full normalled configuration for each jack channel. A non-configurable half normalled (" -HN") bottom row version with solder lugs is also available.

NOTE: Take care when handling digital signals. Do not use Parallel configuration and avoid other parallel paths with Half / Double Normalled configurations. Parallel paths may lead to mismatching.



Grounding

The flexible grounding system allows four possibilities to fit your needs:

- Individual: Each channel ground is separately connected with the corresponding cable shield (default configuration).
- Group: Some channel grounds are PCB connected by making soldering joints on the PCB and by cutting tracks respectively to form a group that is connected to one common cable shield.
- Central: All channel grounds are PCB connected by making soldering joints and wired with only one cable shield.
- Chassis-Common: Same as central grounding with additional connection of the common ground to the Patch Panel chassis by means of a jumper.

Wiring Terminations

TB Patch Panels are available with:

- Spring loaded push terminals (NPP-TB)
- Solder lugs (NPP-TB-HN)

The spring loaded terminal blocks are fast and easy to connect and disconnect the wires. No soldering and screwing necessary. Simply insert the stripped wire after pressing down the white key. Accommodates stranded wires up to AWG 20 (0.5 mm²) and solid wires up to AWG 18 (0.75 mm²).



Ruggedized metal housing



Imprinted grounding instruction



Module
NYS-SPCR1

1/4" Patch Panel



NYS-SPP-L1

- Individual grounding available for each channel separately
- Ruggedized metal housing
- Improved contact design minimises wear on mated plugs
- Economic and versatile designed 1/4" modular Patch Panel with 2 rows of jack sockets
- 48 balanced channels with fully PCB wired jack (24 vertical PC boards), 24 front pairs and corresponding 24 rear pairs
- Jack PC card contains 4 balanced 1/4" jacks with non-tarnishing contacts, is held securely in place without the use of nuts - no little pieces to drop, break or lose
- Easy to change configuration by just flipping individual PC board
- Normalling jack is coloured grey for easy identification
- 4 designation strips included for front and rear panel

Dimensional Drawing



Design Criteria

The NYS-SPP-L1 is a economical and remarkable sleek designed 1/4" modular Patch Panel for 19" rack mount (19" x 1U) with a reinforced metal housing. Each of it's 48 PCB wired balanced channels (24 front pairs and corresponding 24 rear pairs) can either be grounded separately or in groups of individually chooseable channel numbers (detailed information see below).

The PCBs are held securely in place by being clamped between the front and the rear panel, this grants an easy reconfiguration of the Patch Panel without the danger of loosing any small parts (e.g. nuts). The grey jack serves as an easy and distinguishable normalling identification.

Configuration

Standard configuration, when delivered, is Half Normalled bottom row. The configuration can easily be changed by just flipping the individual PCB. Inserting a plug into the

grey jack will always isolate the top against the bottom row. Alternative solution for send/return applications by use of NYS-SPCR1 module (see accessories below).

The following configurations are available:



Grounding

The flexible grounding system, applicable for each channel separately by simply attaching the loose supplied grounding clips to the grounding pad of the corresponding channel, offers the following alternatives:

- Individual (without grounding clip): Each channel ground (sleeve contact) is connected to the dedicated ground contact of the incoming 1/4" plug only. This is the standard configuration for delivery.
- Chassis common Ⓞ: The relevant channel grounds (sleeve contacts; top and bottom row) is connected to the ground flat tab via grounding clip and chassis.
- Chassis top Ⓜ: The dedicated top channel ground (sleeve contact) is connected to the ground flat tab via grounding clip and chassis.
- Chassis bottom Ⓝ: The dedicated bottom channel ground (sleeve contact) is connected to the ground flat tab via grounding clip and chassis.





Standard 4.4mm
bantam jack



Long frame jack
socket

MA 96 and XPM 96 Bantam Patchbays



- Robust designed patchbay to accept standard 4.4 mm Bantam jack connectors (acc. MIL-D-642/13)
- Fitted with 96 Rean die-cast jack sockets
- Constructed from rigid aluminium extrusion which includes 2 integral slots for designation strips
- 96 channels grouped in two row 12 x 8 stereo jacks
- XPM96 features traditional 2 row, 4 x 24 stereo jacks
- Available in 4 colours: black, silver, red or blue
- Suitable for audio, broadcast, data and industrial applications XPM96

Dimensional Drawing





Die-cast frame



Tinned tags

MAJ 501 Bantam Jack Socket



- 5-point Bantam jack socket (Tip, Ring, Sleeve, Tip Normal, Ring Normal)
- Rigid nickel plated die-cast frame, featuring considerable frame strength eliminating physical distortion when plug is inserted
- Nickel-silver spring contacts, palladium plated switch contacts
- Tinned tags for easy soldering

Termination



End Elevations

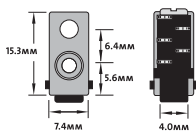

Plan Elevations



Circuit Detail

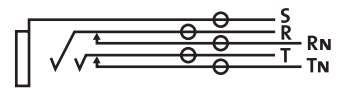



B-Gauge patchbay 48 way longframe

LF 48 B-Gauge Patchbays



- 48 way Longframe B-Gauge patchbay
- Accepts both European BPO 316 and US MIL-P-642/2 style phono plugs
- 2 rows of 24 LF501 jack connectors
- Jack designed from rigid nickel-plated die-cast aluminium with nickel-silver spring contacts
- Available in 4 colours: black, silver, red or blue
- Reliable support for connecting looms by steel lacing bar

Dimensional Drawing

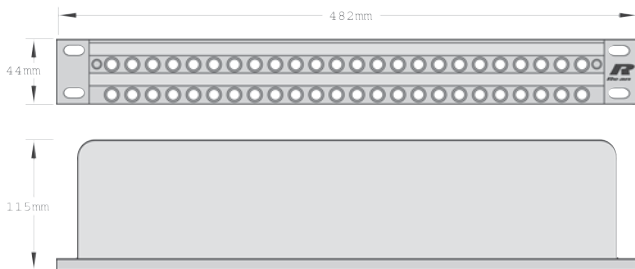



Solder lugs

LFJ 501 B-Gauge Jack Socket



- 5-point B-Gauge jack socket
- Nickel-silver spring contacts
- Palladium plated switch contacts
- Durable die-cast body with bright nickel plated nose
- Termination solder lugs

LFJ 501



Plan Elevations



Circuit Detail

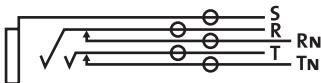

Specifications	NPPA Series	NPP-TB Series	NYS Series	MA 96 and XPM 96	LF 48 Series
----------------	-------------	---------------	------------	------------------	--------------

Electrical

Contact resistance:	< 20 mΩ	< 10 mΩ	< 10 mΩ	< 24 mΩ	< 20 mΩ
Switch contact resistance:	< 25 mΩ	< 15 mΩ	< 10 mΩ	< 26 mΩ	< 15 mΩ
Insulation resistance:	> 1 GΩ @ 500 V dc	●	●	●	●
Dielectric strength:	> 500 V ac	●	●	●	●
	> 1'000 V dc	●	●	-	-
Frequency range:	DC to > 50 MHz	●	●	●	●
Channel separation:	> 100 dB @ 10 kHz, 600 Ω terminated	●	●	●	●
	> 40 dB @ 6 MHz, 110 Ω terminated	●	●	●	●
AES / EBU Signals (digital) suitable:		●	●	●	●
Handles Phantom Power:		●	●	●	●

Mechanical

Life time:	> 20'000 cycles	-	-	-	●	●
	> 10'000 cycles	-	-	●	-	-
	> 5'000 cycles	●	●	-	-	-
Insertion force:	< 25 N	-	-	●	●	-
	< 20 N	-	●	-	-	-
	< 10 N	●	●	-	-	-
Withdrawal force:	> 10 N	●	●	●	●	●
	> 8 N	●	●	-	-	-
Dimensions:	482 x 44 mm (19" x 1U)	●	●	●	●	●
Depth:		178 mm (7")	140 mm (5.5")	64 mm (2.52")	110 mm (4.33")	115 mm (4.53")
Dimension Patch Box:	168 x 77 x 77 mm (6.0 x 3 x 3")					
Temperature range:	-30°C to +80°C	●	●	●	●	●
Mating plug:		4.4 mm (0.173") Bantam plug	B-Gauge 1/4" plug	A-Gauge 1/4" plug acc. EIA RS-453	4.4 mm (0.173") Bantam plug	Longframe B-Gauge plug
Groundin wiring	according flat tab for 3/16" FASTON® (4.8 x 0.8 mm)	MIL-P-642/13	BPO316/MIL-P-642/2	TEC60603-11	MIL-P-642/13	BPO316/MIL-P-642/2
		-	-	●	-	-

Materials

Housing:	Steel	Steel	Steel	anodised Al	anodised Al
Front panel:	anodised Al	Pocan B 3225	Steel	anodised Al	anodised Al
Lacing bar:	Brass	Steel	N / A	coated steel	coated steel
Jack housing:	PA 66 blend	PA 6.6 30% GR	ABS	diecast alloy	diecast Al
Jack contacts:	CuSn6	CuSn6	CuSn6	Ni-Silver	Ni-Silver
	Tribor® plated	Au plated	tin plated	(CuNi18Zn20)	(CuNi18Zn20)
Switch contacts:	Au plated	Au plated	Bronze, tin plated	Palladium plated	Palladium plated
Grounding clip:	-	-	CuSn6, SnCu plated	-	-

Operating Accessories



Labeling software:

Patchlabel is a program to Label Patch Panel designation strips.

Free Download of Patch Label Program (ZIP - 347 KB) on the Web "www.neutrik.com" section "Patch Panels".

Ordering Information

Part Number	Description
-------------	-------------

NPPA Series		Configuration*	Wiring	Grounding
NPPA-TT-PT**	2 x 48 jacks	half normalled bottom	288 push terminals	individual
NPPA-TT-PT-FN**	2 x 48 jacks	full normalled	288 push terminals	individual
NPPA-TT-PT-HNT**	2 x 48 jacks	half normalled top row	288 push terminals	individual
NPPA-TT-PT-I**	2 x 48 jacks	isolated	288 push terminals	individual
NPPA-TT-PT-P**	2 x 48 jacks	parallel	288 push terminals	individual
NPPA-TT-S**	2 x 48 jacks	half normalled bottom	288 solder terminals	individual
NPPA-TT-S-FN**	2 x 48 jacks	full normalled	288 solder terminals	individual
NPPA-TT-S-HNT**	2 x 48 jacks	half normalled top row	288 solder terminals	individual
NPPA-TT-S-I**	2 x 48 jacks	isolated	288 solder terminals	individual
NPPA-TT-S-P**	2 x 48 jacks	parallel	288 solder terminals	individual
NPPA-TT-PT-PH	2 x 48 jacks	half normalled bottom	288 Phoenix push terminals	individual
NPPA-TT-SD50	2 x 48 jacks	half normalled bottom	4 x 50 pole D-SUB	groups of 12 channels
NPPA-TT-SD25	2 x 25 jacks	half normalled bottom	10 x 25 pole D-SUB	groups of 12 channels
NPPA-TT-E56	2 x 48 jacks	half normalled bottom	6 x 56 pole ELCO male connectors	individual
NPPA-TT48-E56	2 x 24 jacks	half normalled bottom	3 x 56 pole ELCO male connectors	individual
NPPA-TT-E90	2 x 48 jacks	half normalled bottom	4 x 90 pole ELCO male connectors	individual
NPPA-TT-IDC	2 x 48 jacks	programmable by jumpers	288 IDC terminals (KRONE-Type)	individual

* fully loaded jack pairs only, to built patch panels with mixed configuration use pre-config jackpairs

** in case of need added normalling bars can be used to reconfigure up to 4 jackpairs

Pre-configured Jack-Pairs

NJ3TTA-4-HNB	blocks of 2 channels	half normalled bottom row	cover ident color: clear
NJ3TTA-4-HNT	blocks of 2 channels	half normalled top row	cover ident color: yellow
NJ3TTA-4-FN	blocks of 2 channels	full normalled	cover ident color: green
NJ3TTA-4-P	blocks of 2 channels	parallel	cover ident color: red
NJ3TTA-4-I	blocks of 2 channels	isolated	cover ident color: orange

Accessories

NPPA-S	Strain Relief bar
--------	-------------------

NPP-TB Series		Configuration	Wiring
NPP-TB	2 x 24 TB (BP0316/MIL-P-642/2) jacks	programmable for all commonly used configurations	push terminals
NPP-TB-HN	2 x 24 TB (BP0316/MIL-P-642/2) jacks	half Normalled Bottom Row	solder tags

Accessories

NPP-LB-**	Channel identification and status plates, pack of 100 per color, 9 different colors
NPP-C	Metal dust cover
NPP-S	A second rear extention bar for fix the very large cables.
NKTB*	Patch cord with NP3TB plugs. Available in black and red. Length: 30, 40, 60, 90 cm

** : 0 - Black, 1 - Brown, 2 - Red, 3 - Orange, 4 - Yellow, 5 - Green, 6 - Blue, 7 - Violet, 8 - Grey, 9 - White; Must be ordered in multiples of 100.

NYS SPPL

NYS-SPP-L1	1/4" Patch Panel, 2 x 24 channels, configuration half normalled, isolated, split
NYS-SPCR1	Send / Return module (Split Print)

Part Number	Description
-------------	-------------

Re'an Bantam Patchbays

MA96-1A	96 way, Red front panel - grouped 12 x 8
MA96-1D	96 way, Blue front panel - grouped 12 x 8
MA96-1O	96 way, Black front panel - grouped 12 x 8
MA96-1S	96 way, Silver front panel - grouped 12 x 8
XPM-96SS	96 way, Silver front panel - grouped 4 x 24
XPM-96SO	96 way, Black front panel - grouped 4 x 24

Bantam Jack Socket

MAJ-501	Standard Solder Tag
---------	---------------------

Re'an Longframe B-Gauge Patchbays

LF48-1A	48 way, Red front panel
LF48-1D	48 way, Blue front panel
LF48-1O	48 way, Black front panel
LF48-1S	48 way, Silver front panel
LFJ-501	Longframe B-Gauge jack socket, standard solder tag

Liechtenstein (Headquarters)

NEUTRIK AG
Im alten Riet 143
9494 Schaan
T +423 237 24 24
F +423 232 53 93
neutrik@neutrik.com

Great Britain

Neutrik (UK) Ltd.
Westridge Business Park
Cothey Way
Ryde, Isle of Wight PO33 1QT
T +44/1983/811 441
sales@neutrik.co.uk

Japan

Neutrik Limited
Yusen-Higashinonbashi-
Ekimae Bldg., 3-7-19
Higashinonbashi, Chuo-ku
Tokyo 103
T +81/3/3663 47 33
mail@neutrik.co.jp

Switzerland

Neutrik Zürich AG
Steinackerstrasse 35
8902 Urdorf
T +41/44/736 50 10
neutrik@neutrik.ch

**Germany/Netherlands/
Austria**

Neutrik Vertriebs GmbH
Felix-Wankel-Strasse 1
85221 Dachau
T +49/8131/28 08 90
info@neutrik.de

USA

Neutrik USA Inc.
195 Lehigh Avenue
Lakewood, NJ 08701-4527
T +1/732/901 94 88
info@neutrikusa.com

France

Neutrik France SARL
Rue du Parchamp, 13
92100 Boulogne-Billancourt
T +33/1/41 31 67 50
info@neutrik-france.com

Hong Kong

Neutrik Hong Kong LTD.
Workshop 14, 16 Floor, Wah
Wai Centre
Nr. 38-40 Au Pui Wan Street
Shatin, New Territories
T +852 2687 6055
neutrik@neutrik.com.hk