

## Base strip - MC 1,5/ 4-G-3,5 - 1844236

Please be informed that the data shown in this PDF Document is generated from our Online Catalog. Please find the complete data in the user's documentation. Our General Terms of Use for Downloads are valid (<http://download.phoenixcontact.com>)



Header, Nominal current: 8 A, Rated voltage (III/2): 160 V, Number of positions: 4, Pitch: 3.5 mm, Color: green, Contact surface: Tin, Assembly: Soldering

The figure shows a 10-position version of the product

### Product Features

- Versions with engagement noses for locking plugs with self-locking flanges
- Plug-in direction parallel and vertical to the PCB
- Low-profile pin strips with compact pitches
- Individual position coding by inserting coding profiles

### Key commercial data

package_quantity	250
GTIN	4017918113278

### Technical data

#### Dimensions

Length	9.2 mm
Pitch	3.5 mm
Dimension a	10.5 mm
Pin dimensions	0,8 x 0,8 mm
Hole diameter	1.2 mm

#### General

Range of articles	MC 1,5/...-G
Insulating material group	IIIa
Rated surge voltage (III/3)	2.5 kV
Rated surge voltage (III/2)	2.5 kV
Rated surge voltage (II/2)	2.5 kV
Rated voltage (III/3)	160 V
Rated voltage (III/2)	160 V
Rated voltage (II/2)	250 V
Connection in acc. with standard	EN-VDE
Nominal current $I_N$	8 A
Maximum load current	8 A
Insulating material	PBT

# Base strip - MC 1,5/ 4-G-3,5 - 1844236

## Technical data

### General

<b>Inflammability class according to UL 94</b>	V0
<b>Color</b>	green
<b>Number of positions</b>	4

## classifications

### eCl@ss

<b>eCl@ss 4.0</b>	272607xx
<b>eCl@ss 4.1</b>	27260701
<b>eCl@ss 5.0</b>	27260701
<b>eCl@ss 5.1</b>	27260701
<b>eCl@ss 6.0</b>	27260704
<b>eCl@ss 7.0</b>	27440402
<b>eCl@ss 8.0</b>	27440402

### ETIM

<b>ETIM 3.0</b>	EC001121
<b>ETIM 4.0</b>	EC002637
<b>ETIM 5.0</b>	EC002637

### UNSPSC

<b>UNSPSC 6.01</b>	30211810
<b>UNSPSC 7.0901</b>	39121409
<b>UNSPSC 11</b>	39121409
<b>UNSPSC 12.01</b>	39121409
<b>UNSPSC 13.2</b>	39121409

## approvals

CSA / UL Recognized / VDE Gutachten mit Fertigungsüberwachung / cUL Recognized / GOST / IECCEB CB Scheme / GOST / CCA / cULus Recognized /

### Approval details

		
<b>Usegroups</b>	<b>B</b>	<b>D</b>
Nominal voltage UN	300 V	300 V
Nominal current IN	8 A	8 A
mm <sup>2</sup> /AWG/kcmil		

# Base strip - MC 1,5/ 4-G-3,5 - 1844236

approvals

**UL Recognized**

Usegroups	B	D
Nominal voltage UN	300 V	300 V
Nominal current IN	8 A	8 A
mm <sup>2</sup> /AWG/kcmil		

**VDE Gutachten mit Fertigungsüberwachung**

Nominal voltage UN	160 V
Nominal current IN	8 A
mm <sup>2</sup> /AWG/kcmil	

**cUL Recognized**

Usegroups	B	D
Nominal voltage UN	300 V	300 V
Nominal current IN	8 A	8 A
mm <sup>2</sup> /AWG/kcmil		

**GOST**

**IECEE CB Scheme**

Nominal voltage UN	160 V
Nominal current IN	8 A
mm <sup>2</sup> /AWG/kcmil	

**CCA**

Nominal voltage UN	160 V
--------------------	-------

# Base strip - MC 1,5/ 4-G-3,5 - 1844236

## approvals

Nominal current IN	8 A
mm <sup>2</sup> /AWG/kcmil	



## accessories

### Labeled terminal marker

SK 3,5/2,8:FORTL.ZAHLEN - 0804073



---

### Coding element

CP-MSTB - 1734634



---

## accessories

MC 1,5/10-LWL 1,5-3,5 - 1841161



MC 1,5/10-LWL 2,3-3,5 - 1841187



# Base strip - MC 1,5/ 4-G-3,5 - 1844236

accessories

MC 1,5/10-LWL 4-3,5 - 1841200



## Drawings

Drilling diagram

Diagram

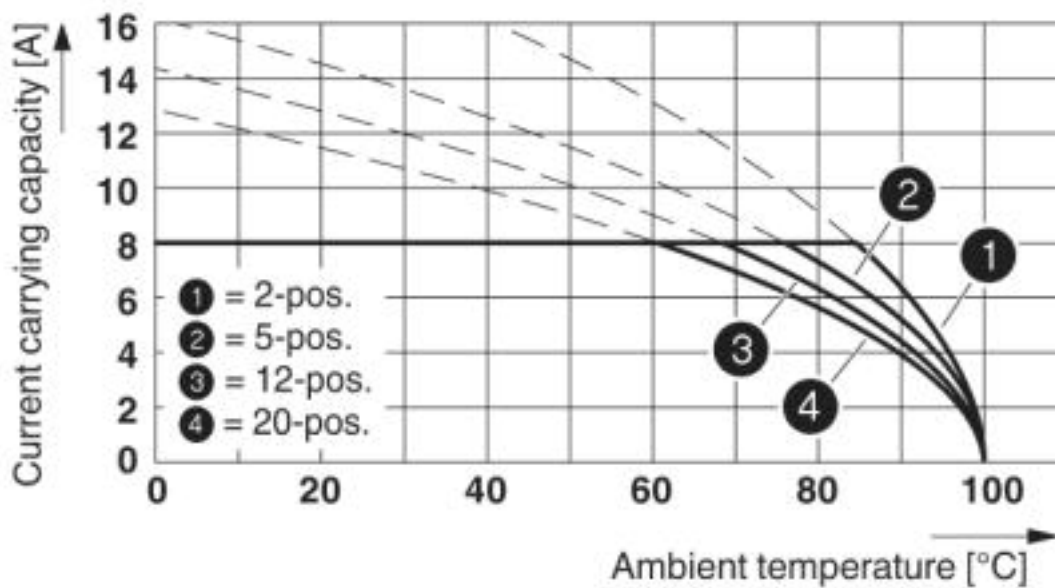

# Base strip - MC 1,5/ 4-G-3,5 - 1844236

Diagram

Plug: MCVR(W) 1,5/5-ST(F)-3,81(3,5)  
Header: MC(V) 1,5/5-G(F)-3,81(3,5)

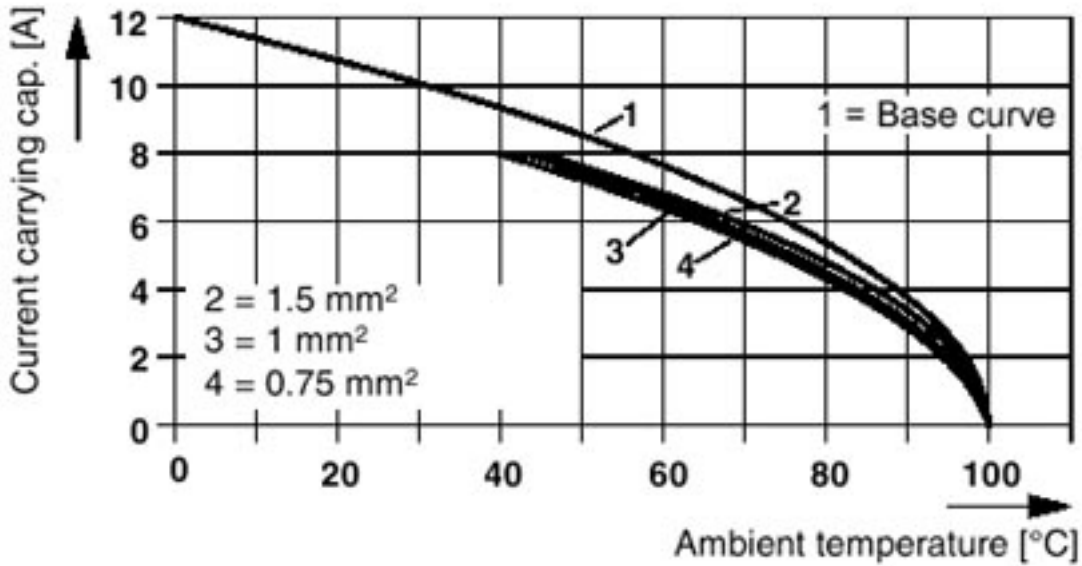

Diagram

Plug: MC 1,5/5-ST(F)-3,81(3,5)  
Header: MC(V) 1,5/5-G(F)-3,81(3,5)

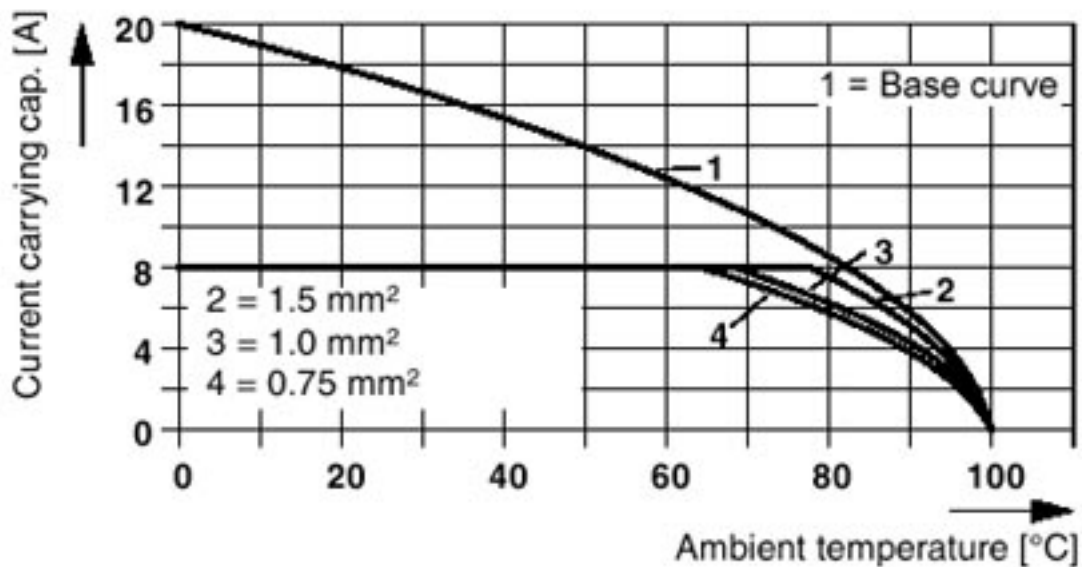

# Base strip - MC 1,5/ 4-G-3,5 - 1844236

Diagram

Plug: FRONT-MC 1,5/5-ST(F)-3,81(3,5)  
 Header: MC(V) 1,5/5-G(F)-3,81(3,5)

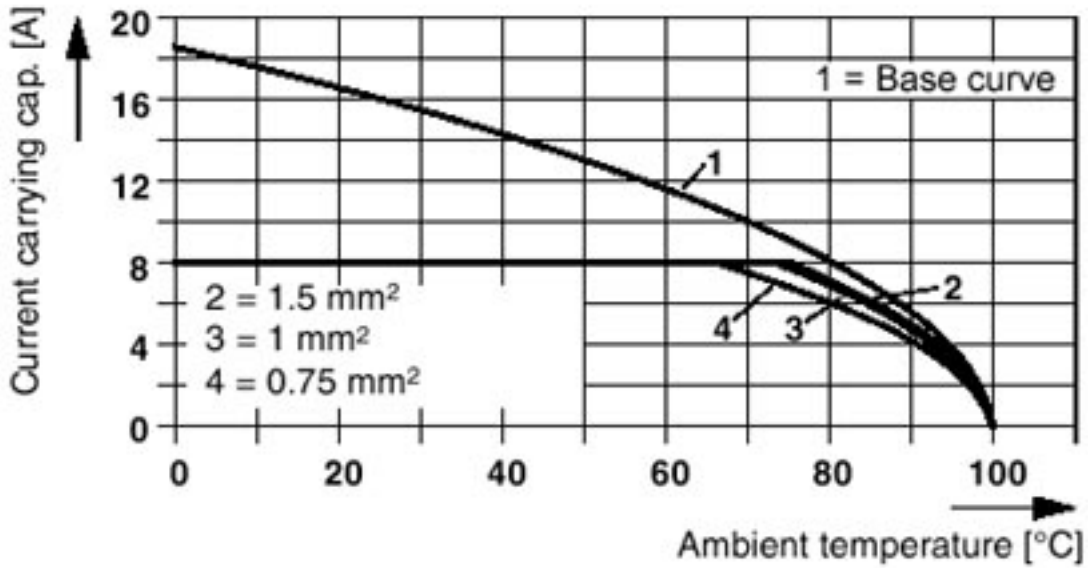

Diagram

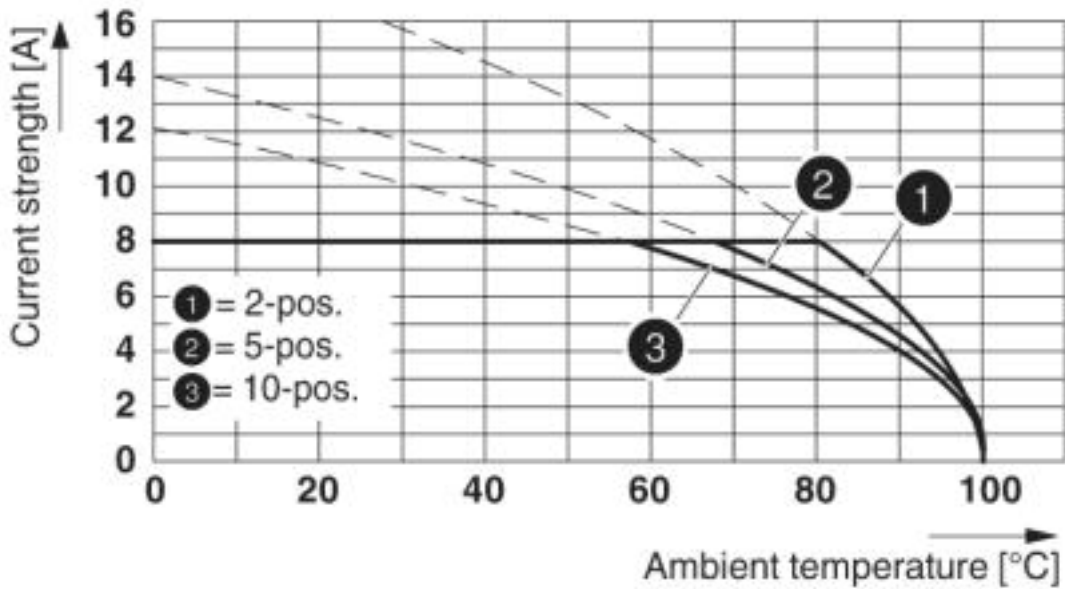

Type: TFMC 1,5/...-ST-3,5 with MC 1,5/...-G-3,5

Diagram

Type: MC 1,5/...-ST-3,5 with MC 1,5/...-G-3,5

# Base strip - MC 1,5/ 4-G-3,5 - 1844236

Dimensioned drawing

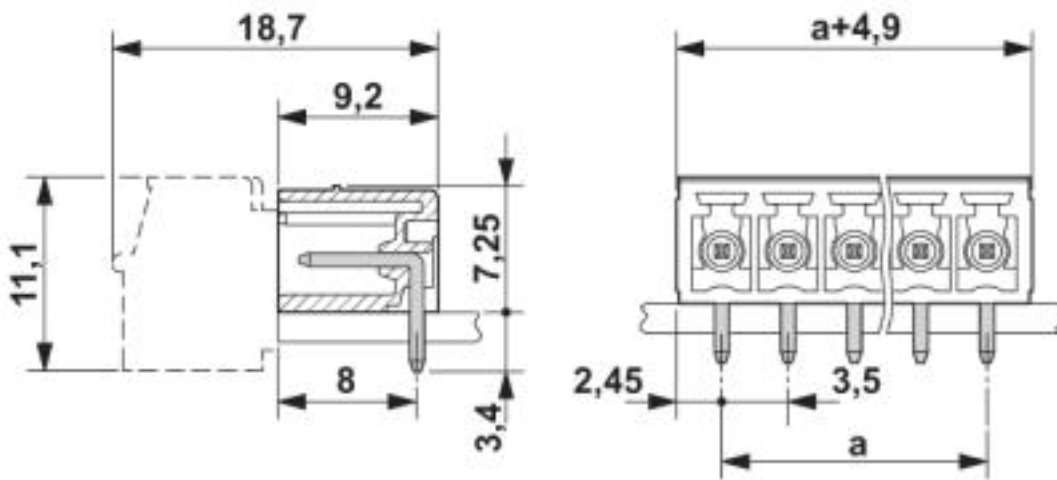

© Phoenix Contact 2013 - all rights reserved  
<http://www.phoenixcontact.com>