

PH CONNECTOR

2.0mm pitch/Disconnectable Crimp style connectors

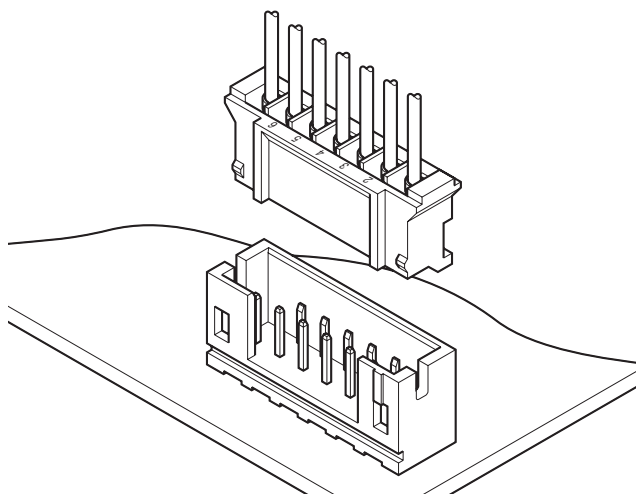

This is a thin, low-profile 2.0mm pitch connector 8.0mm in height after mounting and 4.5mm in width. It is designed to meet the demand for high-density connection of internal wires to printed circuit boards. It is compact, highly reliable and low in cost.

- **Reliable contact**
- **Fully shrouded header**
- **Printed circuit board retention mechanism**
- **Surface mount model (SMT)**

Specifications

- Current rating: 2A AC, DC (AWG #24)
- Voltage rating: 100V AC, DC
- Temperature range: -25°C to +85°C
(including temperature rise in applying electrical current)
- Contact resistance: Initial value/10m Ω max.
After environmental testing/20m Ω max.
- Insulation resistance: 1,000M Ω min.
- Withstanding voltage: 800V AC/minute
- Applicable wire: AWG #32 to #24
- Applicable PC board thickness: 0.8 to 1.6mm
- * Compliant with RoHS.
- * Refer to "General Instruction and Notice when using Terminals and Connectors" at the end of this catalog.
- * Contact JST for details.

Standards

- Ⓜ Recognized E60389
- Ⓢ Certified LR20812
- Ⓡ R75087

PC board layout and Assembly layout

〈Through-hole type (viewed from soldering side)〉

Top entry type

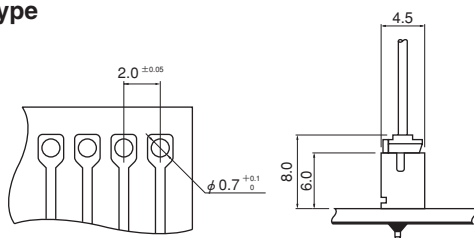

Side entry type

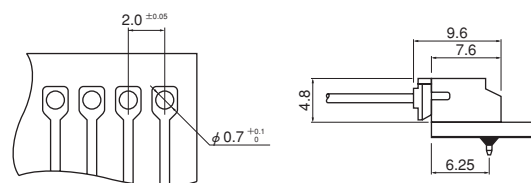

Note: 1. Tolerances are non-cumulative: ±0.05mm for all centers.

2. Hole dimensions differ according to the kind of PC board and piercing method. If PC boards made of hard material are used, the hole dimensions should be larger. The dimensions above should serve as a guideline. Contact JST for details.

〈SMT type (viewed from component side)〉

SM4 type

Top entry type

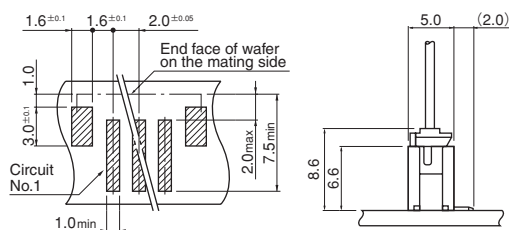

Side entry type

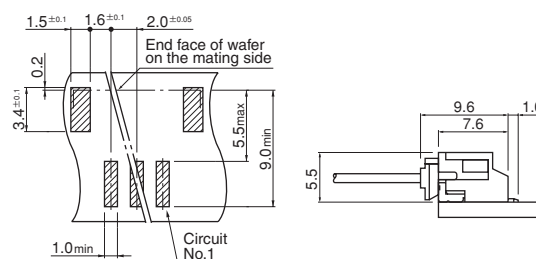

Note: 1. Tolerances are non-cumulative: ±0.05mm for all centers.

2. The dimensions above should serve as a guideline. Contact JST for details.

PH CONNECTOR

Contact

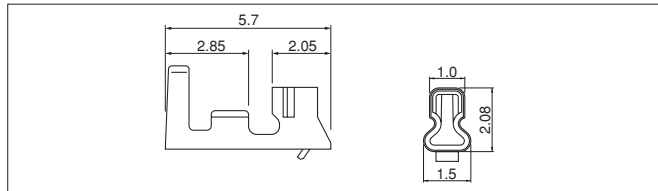

| Contact | Crimping machine | Applicator | | |
|----------------|------------------|------------------|------------------|----------------------------|
| | | Crimp applicator | Dies | Crimp applicator with dies |
| SPH-002T-P0.5S | AP-K2N | MKS-LS · MKS-L | MK/SPH-002-05S | APLMK SPH002-05S |
| | | *MKS-SC | SC/SPH-002-05S | APLSC SPH002-05S |
| SPH-002T-P0.5L | | MKS-LS · MKS-L | MK/SPH-002-05L | APLMK SPH002-05L |
| | | *MKS-SC | SC/SPH-002-05L | APLSC SPH002-05L |
| SPH-004T-P0.5S | MKS-L-10 | MK/SPH-004-05S | APLMK SPH004-05S | |
| | *MKS-SC-10 | SC/SPH-004-05S | APLSC SPH004-05S | |

Note: *Strip-crimp applicator

| Model No. | Applicable wire | | | Q'ty / reel |
|----------------|-----------------|-------|----------------------|-------------|
| | mm ² | AWG # | Insulation O.D. (mm) | |
| SPH-002T-P0.5S | 0.05 ~ 0.22 | 30~24 | 0.9~1.5 | 8,000 |
| SPH-002T-P0.5L | 0.08 ~ 0.22 | 28~24 | 0.8~1.5 | |
| SPH-004T-P0.5S | 0.032~0.08 | 32~28 | 0.5~0.9 | 10,000 |

Material and Finish

Phosphor bronze, tin-plated (reflow treatment)

RoHS compliance

Note:

- Contact JST for gold-plated products.
- SPH-002T-P0.5L is low-insertion force type contact, for easier insertion/withdrawal, which would be less resistant to the vibration. The crimp height is different from the standard.
- Contact JST for details.

Housing

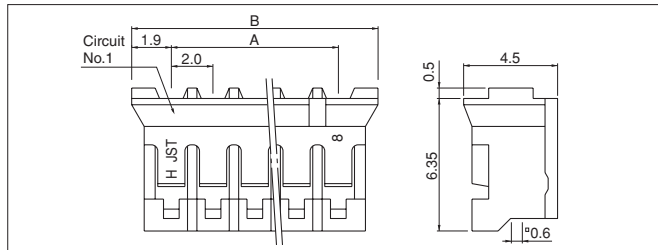

<For reference> As the color identification, the following alphabet shall be put in the underlined part. For availability, delivery and minimum order quantity, contact JST.

ex. **PHR-2-oo**

(blank)...natural (white)

BK...black R...red TR...tomato red BL...blue Y...yellow

L...lemon yellow M...green D...orange N...brown

P...purple PK...pink H...gray LE...light blue

FY...vivid yellow DPK...dark pink

| Circuits | Model No. | Dimensions (mm) | | Q'ty / box |
|----------|---------------|-----------------|------|------------|
| | | A | B | |
| 2 | PHR-2 | 2.0 | 5.8 | 1,000 |
| 3 | PHR-3 | 4.0 | 7.8 | 1,000 |
| 4 | PHR-4 | 6.0 | 9.8 | 1,000 |
| 5 | PHR-5 | 8.0 | 11.8 | 1,000 |
| 6 | PHR-6 | 10.0 | 13.8 | 1,000 |
| 7 | PHR-7 | 12.0 | 15.8 | 1,000 |
| 8 | PHR-8 | 14.0 | 17.8 | 1,000 |
| 9 | PHR-9 | 16.0 | 19.8 | 1,000 |
| 10 | PHR-10 | 18.0 | 21.8 | 1,000 |
| 11 | PHR-11 | 20.0 | 23.8 | 1,000 |
| 12 | PHR-12 | 22.0 | 25.8 | 1,000 |
| 13 | PHR-13 | 24.0 | 27.8 | 1,000 |
| 14 | PHR-14 | 26.0 | 29.8 | 1,000 |
| 15 | PHR-15 | 28.0 | 31.8 | 1,000 |
| 16 | PHR-16 | 30.0 | 33.8 | 1,000 |

Material

PA 66, UL94V-0, natural (white)

RoHS compliance

Through-hole type shrouded header

Top entry type

(2 circuits)

(3 circuits or more)

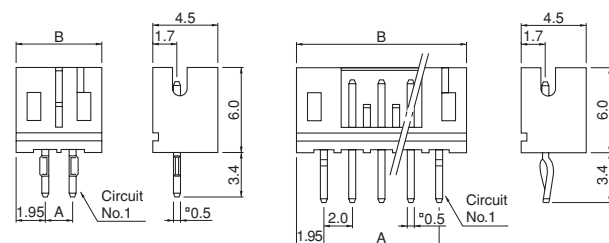

Side entry type

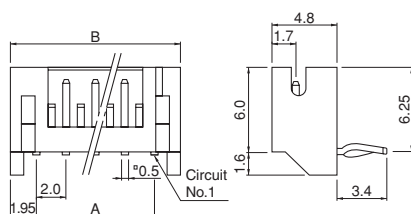

| Circuits | Model No. | | Dimensions (mm) | | Q'ty / box | |
|----------|--------------------|--------------------|-----------------|------|----------------|-----------------|
| | Top entry type | Side entry type | A | B | Top entry type | Side entry type |
| 2 | B2B-PH-K-S | S2B-PH-K-S | 2.0 | 5.9 | 1,000 | 1,000 |
| 3 | B3B-PH-K-S | S3B-PH-K-S | 4.0 | 7.9 | 1,000 | 1,000 |
| 4 | B4B-PH-K-S | S4B-PH-K-S | 6.0 | 9.9 | 1,000 | 500 |
| 5 | B5B-PH-K-S | S5B-PH-K-S | 8.0 | 11.9 | 1,000 | 500 |
| 6 | B6B-PH-K-S | S6B-PH-K-S | 10.0 | 13.9 | 1,000 | 500 |
| 7 | B7B-PH-K-S | S7B-PH-K-S | 12.0 | 15.9 | 500 | 500 |
| 8 | B8B-PH-K-S | S8B-PH-K-S | 14.0 | 17.9 | 500 | 250 |
| 9 | B9B-PH-K-S | S9B-PH-K-S | 16.0 | 19.9 | 500 | 250 |
| 10 | B10B-PH-K-S | S10B-PH-K-S | 18.0 | 21.9 | 500 | 250 |
| 11 | B11B-PH-K-S | S11B-PH-K-S | 20.0 | 23.9 | 500 | 250 |
| 12 | B12B-PH-K-S | S12B-PH-K-S | 22.0 | 25.9 | 400 | 250 |
| 13 | B13B-PH-K-S | S13B-PH-K-S | 24.0 | 27.9 | 250 | 250 |
| 14 | B14B-PH-K-S | S14B-PH-K-S | 26.0 | 29.9 | 250 | 250 |
| 15 | B15B-PH-K-S | S15B-PH-K-S | 28.0 | 31.9 | 250 | 200 |
| 16 | B16B-PH-K-S | S16B-PH-K-S | 30.0 | 33.9 | 250 | 200 |

Material and Finish

Post: Brass, copper-undercoated, tin-plated (reflow treatment)
Wafer: PA 66, UL94V-0, natural (white)

RoHS compliance

This product displays (LF)(SN) on a label.
<For reference> As the color identification, the following alphabet shall be put in the underlined part. For availability, delivery and minimum order quantity, contact JST.

ex. **B2B-PH-K-oo**

S...natural (white)

K...black R...red TR...tomato red

E...blue Y...yellow L...lemon yellow M...green

O...orange N...brown P...purple PK...pink H...gray

LE...light blue FY...vivid yellow (blank)...ivory

PH CONNECTOR

Through-hole type shrouded header <Low insertion force type>

Top entry type

(2 circuits)

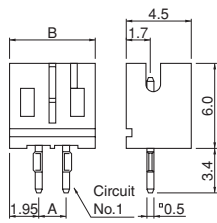

(3 circuits or more)

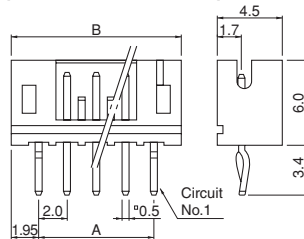

Side entry type

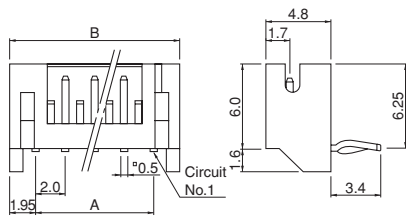

| Circuits | Model No. | | Dimensions (mm) | | Q'ty / box | |
|----------|-------------------|-------------------|-----------------|------|----------------|-----------------|
| | Top entry type | Side entry type | A | B | Top entry type | Side entry type |
| 2 | B2B-PH-KL | S2B-PH-KL | 2.0 | 5.9 | 1,000 | 1,000 |
| 3 | B3B-PH-KL | S3B-PH-KL | 4.0 | 7.9 | 1,000 | 1,000 |
| 4 | B4B-PH-KL | S4B-PH-KL | 6.0 | 9.9 | 1,000 | 500 |
| 5 | B5B-PH-KL | S5B-PH-KL | 8.0 | 11.9 | 1,000 | 500 |
| 6 | B6B-PH-KL | S6B-PH-KL | 10.0 | 13.9 | 1,000 | 500 |
| 7 | B7B-PH-KL | S7B-PH-KL | 12.0 | 15.9 | 500 | 500 |
| 8 | B8B-PH-KL | S8B-PH-KL | 14.0 | 17.9 | 500 | 250 |
| 9 | B9B-PH-KL | S9B-PH-KL | 16.0 | 19.9 | 500 | 250 |
| 10 | B10B-PH-KL | S10B-PH-KL | 18.0 | 21.9 | 500 | 250 |
| 11 | B11B-PH-KL | S11B-PH-KL | 20.0 | 23.9 | 500 | 250 |
| 12 | B12B-PH-KL | S12B-PH-KL | 22.0 | 25.9 | 400 | 250 |
| 13 | B13B-PH-KL | S13B-PH-KL | 24.0 | 27.9 | 250 | 250 |
| 14 | B14B-PH-KL | S14B-PH-KL | 26.0 | 29.9 | 250 | 200 |
| 15 | B15B-PH-KL | S15B-PH-KL | 28.0 | 31.9 | 250 | 200 |
| 16 | B16B-PH-KL | S16B-PH-KL | 30.0 | 33.9 | 250 | 200 |

Material and Finish

Post: Copper alloy, copper-undercoated, tin-plated (reflow treatment)
Wafer: PA 66, UL94V-0, gray

RoHS compliance This product displays (LF)(SN) on a label.

<For reference> As the color identification, the following alphabet shall be put in the underlined part. For availability, delivery and minimum order quantity, contact JST.

ex. **B2B-PH-KL-oo**
(blank)...gray
R...red E...blue S...natural (white)

SMT type shrouded header

Top entry type

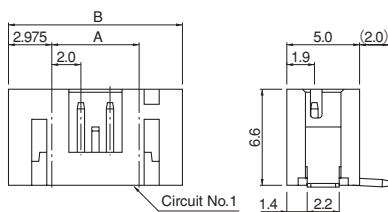

Side entry type

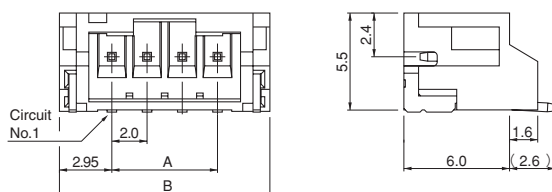

| Circuits | Model No. | | Dimensions (mm) | | | Q'ty / reel |
|----------|-----------------------|-----------------------|-----------------|----------------|-----------------|-------------|
| | Top entry type | Side entry type | A | B | | |
| | | | | Top entry type | Side entry type | |
| 2 | B2B-PH-SM4-TB | S2B-PH-SM4-TB | 2.0 | 7.95 | 7.9 | 1,000 |
| 3 | B3B-PH-SM4-TB | S3B-PH-SM4-TB | 4.0 | 9.95 | 9.9 | 1,000 |
| 4 | B4B-PH-SM4-TB | S4B-PH-SM4-TB | 6.0 | 11.95 | 11.9 | 1,000 |
| 5 | B5B-PH-SM4-TB | S5B-PH-SM4-TB | 8.0 | 13.95 | 13.9 | 1,000 |
| 6 | B6B-PH-SM4-TB | S6B-PH-SM4-TB | 10.0 | 15.95 | 15.9 | 1,000 |
| 7 | B7B-PH-SM4-TB | S7B-PH-SM4-TB | 12.0 | 17.95 | 17.9 | 1,000 |
| 8 | B8B-PH-SM4-TB | S8B-PH-SM4-TB | 14.0 | 19.95 | 19.9 | 1,000 |
| 9 | B9B-PH-SM4-TB | S9B-PH-SM4-TB | 16.0 | 21.95 | 21.9 | 1,000 |
| 10 | B10B-PH-SM4-TB | S10B-PH-SM4-TB | 18.0 | 23.95 | 23.9 | 1,000 |
| 11 | B11B-PH-SM4-TB | S11B-PH-SM4-TB | 20.0 | 25.95 | 25.9 | 1,000 |
| 12 | B12B-PH-SM4-TB | S12B-PH-SM4-TB | 22.0 | 27.95 | 27.9 | 1,000 |
| 13 | B13B-PH-SM4-TB | S13B-PH-SM4-TB | 24.0 | 29.95 | 29.9 | 1,000 |
| 14 | B14B-PH-SM4-TB | S14B-PH-SM4-TB | 26.0 | 31.95 | 31.9 | 1,000 |
| 15 | B15B-PH-SM4-TB | S15B-PH-SM4-TB | 28.0 | 33.95 | 33.9 | 1,000 |
| 16 | B16B-PH-SM4-TB | — | 30.0 | 35.95 | — | 1,000 |

Material and Finish

Post: Copper alloy, copper-undercoated, tin-plated (reflow treatment)
Wafer: PA, UL94V-0, natural (ivory)
Solder tab: Brass, copper-undercoated, tin-plated (reflow treatment)

RoHS compliance This product displays (LF)(SN) on a label.

Note: Contact JST for the top entry type headers with suction cap.

<For reference> As the color identification, the following alphabet shall be put in the underlined part. For availability, delivery and minimum order quantity, contact JST.

ex. **B2B-PH-SM4-oo-TB**
(blank)...natural (ivory)
R...red E...blue M...green L...lemon yellow K...black
DPK...dark pink