

Device terminal block - G 5/ 3 - 2716033

Please be informed that the data shown in this PDF Document is generated from our Online Catalog. Please find the complete data in the user's documentation. Our General Terms of Use for Downloads are valid (<http://download.phoenixcontact.com>)



Device terminal block, for direct mounting, 3-pos.

The illustration shows a combination of versions G 5/2, G 5/3 and G 5/4

Product Features

- Touch-proof shock protection

Key commercial data

package_quantity	50
GTIN	4017918061777

Technical data

General

Number of levels	1
Number of connections	6
Color	gray
Insulating material	PA
Inflammability class according to UL 94	V2

General

Maximum load current	32 A (with 4 mm ² conductor cross section)
Rated surge voltage	6 kV
Pollution degree	3
Surge voltage category	III
Insulating material group	I
Connection in acc. with standard	IEC 60947-7-1/IEC 60998
Nominal current I _N	32 A
Nominal voltage U _N	500 V
Number of positions	3

Dimensions

Width	31 mm
Length	22 mm
Height	24 mm

Device terminal block - G 5/ 3 - 2716033

Technical data

Connection data

Conductor cross section solid min.	0.2 mm ²
Conductor cross section solid max.	4 mm ²
Conductor cross section AWG/kcmil min.	24
Conductor cross section AWG/kcmil max	12
Conductor cross section stranded min.	0.2 mm ²
Conductor cross section stranded max.	4 mm ²
Min. AWG conductor cross section, stranded	24
Max. AWG conductor cross section, stranded	12
Conductor cross section stranded, with ferrule without plastic sleeve min.	0.25 mm ²
Conductor cross section stranded, with ferrule without plastic sleeve max.	4 mm ²
Conductor cross section stranded, with ferrule with plastic sleeve min.	0.25 mm ²
Conductor cross section stranded, with ferrule with plastic sleeve max.	2.5 mm ²
2 conductors with same cross section, solid min.	0.2 mm ²
2 conductors with same cross section, solid max.	1.5 mm ²
2 conductors with same cross section, stranded min.	0.2 mm ²
2 conductors with same cross section, stranded max.	1.5 mm ²
2 conductors with same cross section, stranded, TWIN ferrules with plastic sleeve, min.	0.5 mm ²
2 conductors with same cross section, stranded, TWIN ferrules with plastic sleeve, max.	1 mm ²
2 conductors with same cross section, stranded, ferrules without plastic sleeve, min.	0.25 mm ²
2 conductors with same cross section, stranded, ferrules without plastic sleeve, max.	1.5 mm ²
Connection method	Screw connection
Stripping length	8 mm
Internal cylindrical gage	A3
Screw thread	M3
Tightening torque, min	0.6 Nm
Tightening torque max	0.8 Nm

classifications

eCl@ss

eCl@ss 4.0	27141106
eCl@ss 4.1	27141106
eCl@ss 5.0	27141106
eCl@ss 5.1	27141106
eCl@ss 6.0	27141106
eCl@ss 7.0	27141106

Device terminal block - G 5/ 3 - 2716033

classifications

eCl@ss

eCl@ss 8.0	27141106
------------	----------

ETIM

ETIM 2.0	EC001284
ETIM 3.0	EC001284
ETIM 4.0	EC001284
ETIM 5.0	EC001284

UNSPSC

UNSPSC 6.01	30211811
UNSPSC 7.0901	39121410
UNSPSC 11	39121410
UNSPSC 12.01	39121410
UNSPSC 13.2	39121410

approvals

CSA / UL Recognized / cUL Recognized / GOST / GL / RS / PRS / NK / GOST / cULus Recognized /

Approval details

Nominal voltage UN	300 V
Nominal current IN	30 A
mm ² /AWG/kcmil	28-10

Nominal voltage UN	300 V
Nominal current IN	30 A
mm ² /AWG/kcmil	26-10

Nominal voltage UN	300 V
Nominal current IN	30 A

Device terminal block - G 5/ 3 - 2716033

approvals

mm ² /AWG/kcmil	26-10
----------------------------	-------

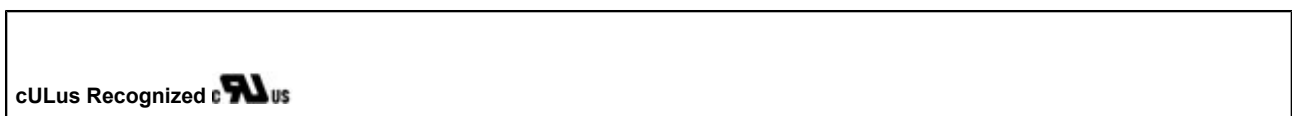
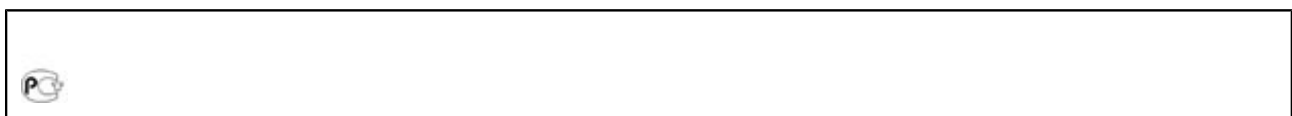
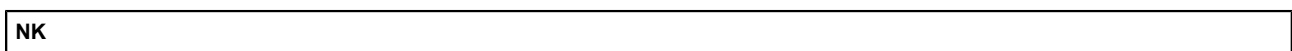
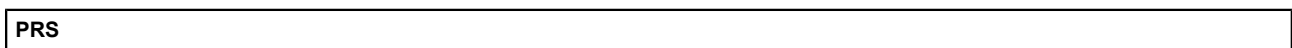
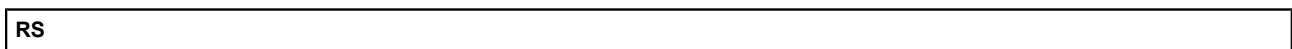

accessories

Terminal marking

BN WH - 1401404



Screwdriver tools

SZS 0,6X3,5 - 1205053



Device terminal block - G 5/ 3 - 2716033

accessories

Labeled terminal marker

WS-G5/3 - 2720032



Drawings

Dimensioned drawing

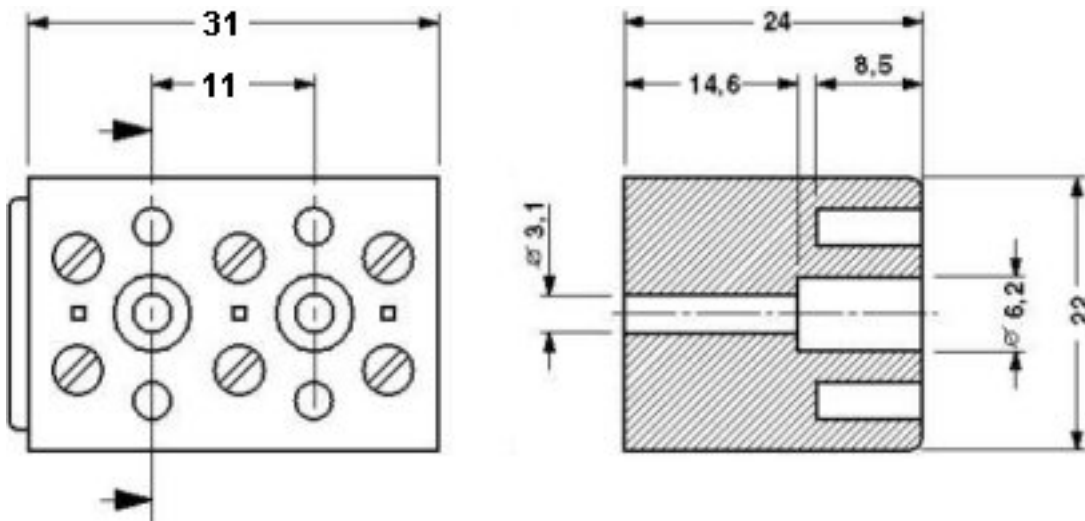

Device terminal block - G 5/ 3 - 2716033

Circuit diagram

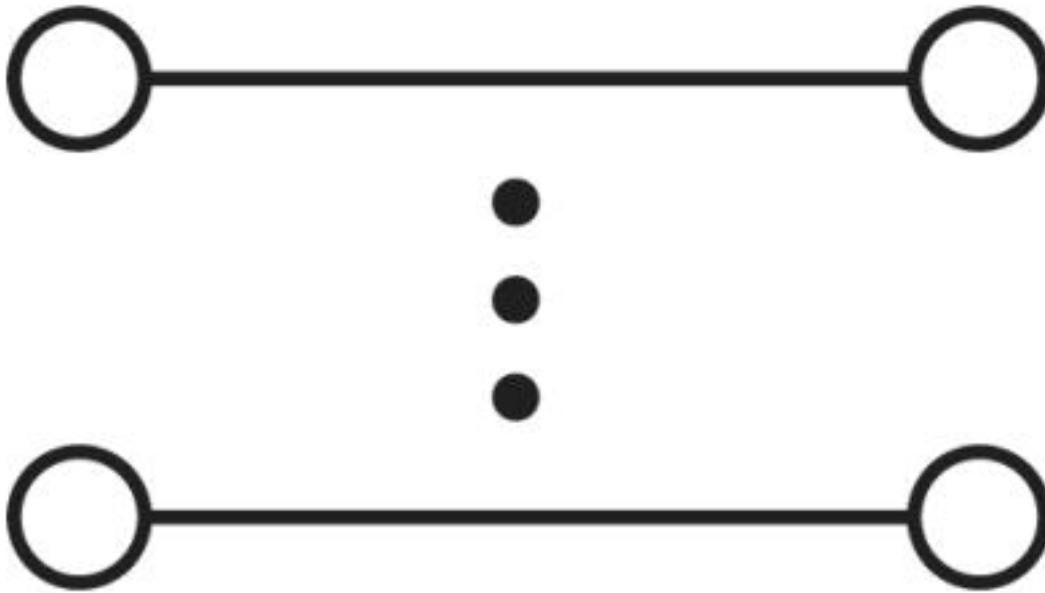

© Phoenix Contact 2013 - all rights reserved
<http://www.phoenixcontact.com>