

5

4

3

2

1

D

C

B

A

Hood lower part

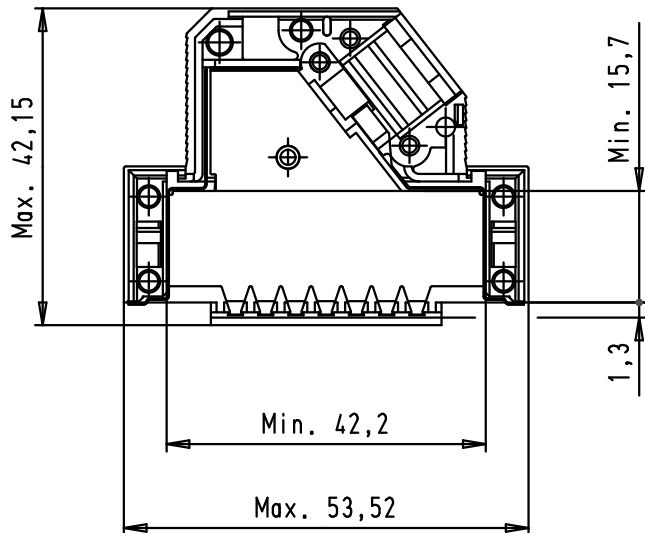
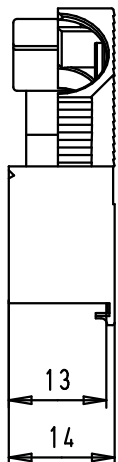

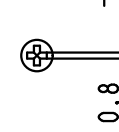
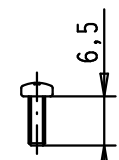
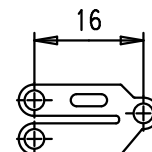
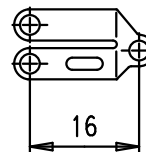
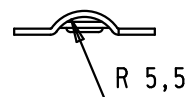
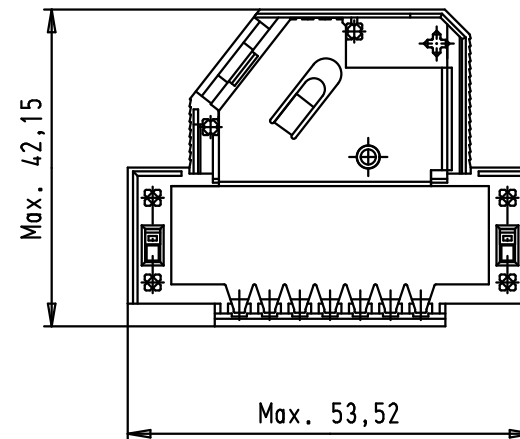
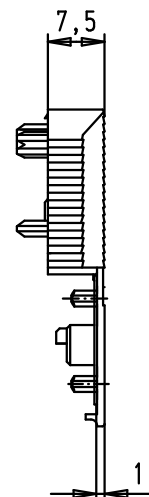

Hood upper part



Strain relief 1

Strain relief 2

Flathead screws

				Dot.	Name	 All Dim. in mm Orig. Size DIN A 4	D-Sub Hoods 25 Poles Shielded	Maßstab/ Scale 1:1
			Detail.	27/02/03	SH			
			Insp.					
			Stand.					
33806	26/09/06	PK	HARTING EURL F-95972 Paris				TB 09 67 025 0573	Blatt/ Page 1 / 1
31392	27/02/03	SH						
Mod.	Dot.	Name						
							Sub.	