

Assembly Instruction MHDTZK / MHD45ZK RA / RAHI

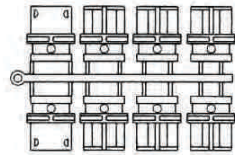
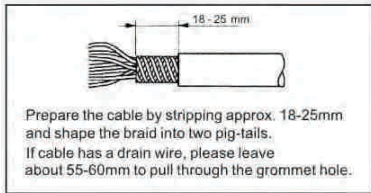

Select the ferrule halves that most closely match the diameter of the cable.
(The ferrule halves do not need to match)

Foil Cable

Insert the wire through the hole in one of the two ferrule halves as shown in Fig 1. Assemble the two halves around the cable and make sure that the insulation runs the full length of the ferrule, then complete as shown in Fig 2.

Loop the earth wire recess as shown, preferably in a "knot".
The earth wire can be insulated and extended to a contact on the connector if required.

Braided Cable

For heavily braided cables, pigtail the braid and turn it back over the ferrule as shown in Fig 3.

For light braided cables, pigtail the braid and turn it back over the ferrule in one direction only.

Place the assembly into the hood half as shown in Fig 4.

Complete the assembly by putting the second hood half over the assembly, and tighten with accompanied screw mounting set.
Recommended Torque is 150 - 200 Ncm

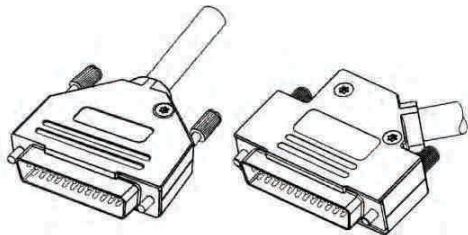
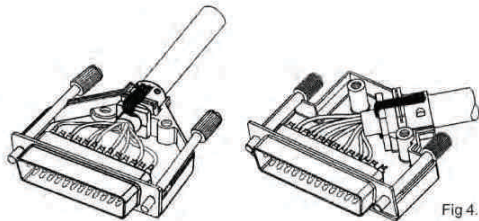
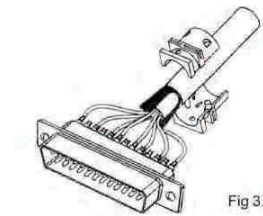
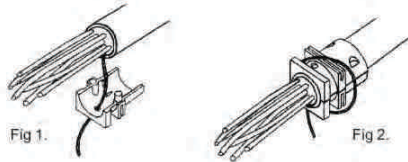

Assembly Instruction MHDTZK / MHD45ZK - ADK Series

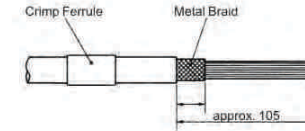

Prepare Cable as shown.
Slide Crimp Ferrule over Cable.

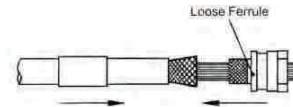

Put wires through and shape Metal Braid around Loose Ferrule.

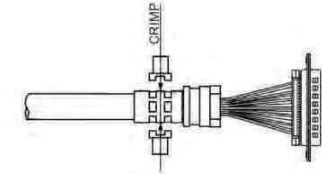

Crimp over the loose Crimp Ferrule.
Mount the Sub-D Connector.

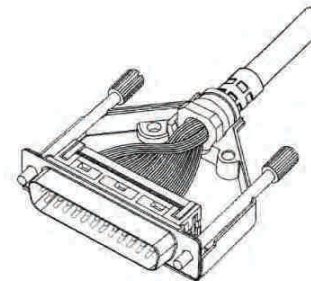

Place the assembly inside the metal cover.

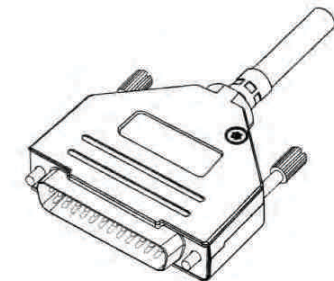

Close assembly by placing the upper Metal Part and screw together with accompanied screws.

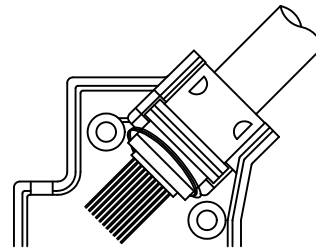
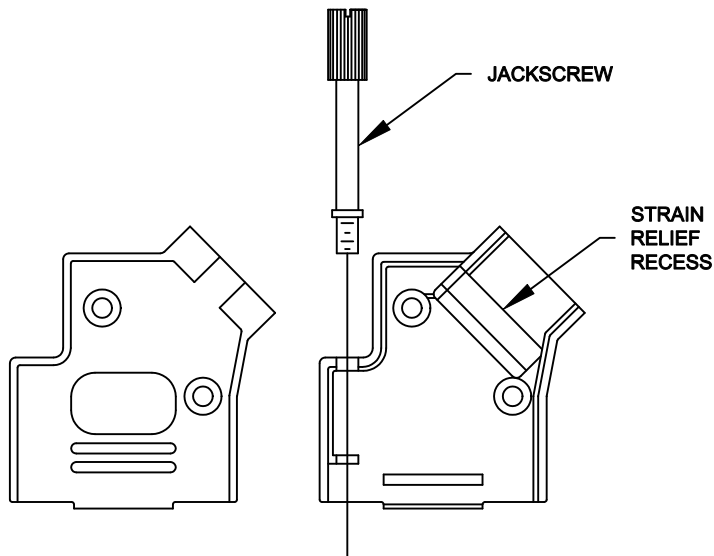

ITEM No. 2, 3 & 4

1. PREPARE CABLE AS REQUIRED TO ASSEMBLE TO THE CONNECTOR
2. CHOOSE THE STRAIN RELIEF HALVES THAT MOST CLOSELY MATCH THE CABLE O/D. THEY DO NOT NEED TO BE MATCHING HALVES
3. WRAP THE SHIELD/GROUND AROUND THE STRAIN RELIEF AS IN FIG. 2 OR FIG. 3 AND AS OUTLINED BELOW
4. PLACE THE CABLE ASSEMBLY/STRAIN RELIEF INTO THE APPROPRIATE RECESS IN ONE HALF OF THE DIE CAST HOOD. ENSURE THE STRAIN RELIEF IS PRESSED INTO THE STRAIN RELIEF RECESS AREA
5. SNAP THE JACKSCREWS INTO POSITION
6. PLACE THE OTHER HALF OF THE DIE CAST HOOD INTO PLACE AND TIGHTEN TOGETHER WITH THE ASSEMBLY SCREWS

FOIL CABLE

1. INSERT THE GROUND WIRE THROUGH HOLE IN ONE HALF OF THE STRAIN RELIEF AS SHOWN IN FIG 1. ASSEMBLE THE TWO HALVES OF THE STRAIN RELIEF AROUND THE CABLE MAKING SURE THAT THE CABLE INSULATION RUNS THROUGH THE FULL LENGTH OF THE STRAIN RELIEF, THEN COMPLETE AS IN FIG 2
2. LOOP THE GROUND WIRE AROUND THE GROUND WIRE RECESS AS SHOWN
3. PLACE THE ASSEMBLY INTO THE LOWER HALF OF THE HOOD MAKING SURE THAT THE GROUND WIRE IS SHOWING FROM UNDER THE CONTACT AREA OF THE STRAIN RELIEF ASSEMBLY AS IN FIG 2
4. THE GROUND WIRE CAN BE INSULATED AND EXTENDED TO A CONTACT ON THE CONNECTOR IF REQUIRED

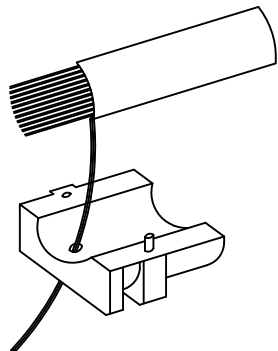

FIG. 1

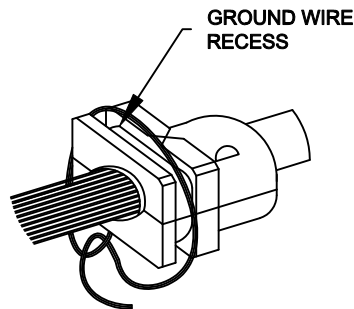

FIG. 2

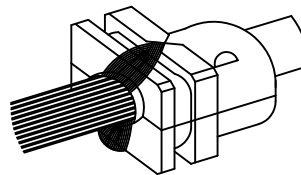

FIG. 3

BRADED CABLE

1. FOR HEAVILY BRAIDED CABLE, PIGTAIL THE BRAID INTO TWO BRAIDS, AND BRING IT BACK OVER THE ASSEMBLED STRAIN RELIEF. SEE FIG 3
2. FOR LIGHT BRAIDED CABLE, PIGTAIL THE BRAID INTO ONE BRAID, AND BRING IT BACK IN ONE DIRECTION ONLY
3. SLOT THE ASSEMBLY INTO THE HOOD AND COMPLETE THE HOOD ASSEMBLY

DIE CAST

THESE DRAWINGS AND SPECIFICATIONS ARE THE PROPERTY OF MH CONNECTORS LTD. AND SHALL NOT BE REPRODUCED, COPIED OR USED AS THE BASIS FOR THE MANUFACTURE OR SALE OF APPARATUS WITHOUT WRITTEN PERMISSION.

DRAWN P. JENKINS		DATE 03-23-12	
APPROVED D. CROFT		DATE 03-23-12	
SCALE NTS	SHEET 1	OF 1	REV: A



MH CONNECTORS LTD.

DRAWING No
MHD45ZK ASSEMBLY