



# Product Guide | 2008

**NEUTRIK**



# The Neutrik® Line

|  |  |  |  |                     |
|--|--|--|--|---------------------|
| <p><b>XLR<br/>Connectors</b></p>         |    |  |  | <p>P. 7 - 30</p>    |
| <p><b>Plugs<br/>&amp;<br/>Jacks</b></p>  |    |  |  | <p>P. 31 - 48</p>   |
| <p><b>Loudspeaker<br/>Connectors</b></p> |    |  |  | <p>P. 49 - 62</p>   |
| <p><b>Data<br/>Connectors</b></p>        |   |  |  | <p>P. 63 - 80</p>   |
| <p><b>BNC<br/>Connectors</b></p>         |  |  |  | <p>P. 81 - 93</p>   |
| <p><b>Circular<br/>Connectors</b></p>    |  |  |  | <p>P. 94 - 108</p>  |
| <p><b>Accessories</b></p>                |  |  |  | <p>P. 109 - 118</p> |
| <p><b>Patch Panels</b></p>               |  |  |  | <p>P. 119 - 133</p> |



## About Neutrik®

Neutrik® is an international corporation with three decades of know-how and experience in the manufacture of innovative electrical and electronic interconnection products and systems. The company was founded in 1975 as a two man operation with the idea to creating innovative products utilizing the latest in mechanical and electronic know-how and creativity. Today we are the world leader in the design, manufacture and marketing of audio, coaxial, power and circular connectors. Our main priority is to be „one step ahead“, i. e. to understand the future market needs before they become obvious and to accommodate demands before they occur.

From the beginning Neutrik has concentrated on the development of innovative audio connector products. Today Neutrik® leads the way in the professional audio market.

Our audio range includes XLR-connectors, plugs, jacks, speaker connectors, patch bays and fiber optic connection systems. Many patents granted, numerous patents pending and the many license agreements since our beginning in 1975, evidence Neutrik's innovation and creative achievements. No doubt, our customers have the confidence in having high quality products at an unsurpassed cost/performance ratio whenever they come across Neutrik®.

Neutrik's strength lies in it's ability to anticipate the needs of a dynamic marketplace, fast response through innovative designs, features and benefits based on customer feed-back as well application of state-of-the-art production technologies. Neutrik® is committed to excellence in innovation, total quality based on ISO 9001-2000, reliable customer relationship and effective marketing.

## Neutrik Group

The Neutrik® Group consists of strategically placed subsidiaries in the United States of America, Great Britain, Switzerland, France, Japan, China and Germany. A network of exclusive distributors in more than 80 countries worldwide provides worldwide sales, technical support and distribution. The corporate headquarters is located in Schaan in the Principality of Liechtenstein, where all operations such as management, R&D, logistics, manufacturing and finance are centered.

## Quality

For Neutrik®, quality is the utmost priority. Uncompromising selection of designs, materials and subcontractors as well as manufacturing technologies guarantee the highest level of quality. Neutrik® holds several approvals with manufacturing compliance organizations including UL, cUL, VDE, SEV, CSA. A sophisticated quality system is in place based on ISO 9001-2000 with full traceability of production runs and the supply chain.

## Customer Service

It is the Neutrik® philosophy to be customer-orientated and to stay in close contact with our customers all over the world, using an international network of subsidiaries, associated companies and distributors, Neutrik® takes care of consultation, sales and after-sales-service.



## Environmental – Compatibility

Neutrik® is committed to the preservation of environmental resources and that our products are developed and manufactured in an environmentally sound and acceptable manner considering health and safety excellence.

We comply with all relevant government laws and directions which relate to environmental protection. We support with all means available to us the preservation of natural resources by economizing the use of materials and by recycling waste. We develop products and processes which are safe, conserve energy and make use of materials which are at a minimum impact on the environment and, where possible, permit recycling.

All production methods are based on environmentally sound handling and the elimination of hazardous material. Some time before the amended EU Directive RoHS (Reduction of

Hazardous Substances) came into force on July 1st 2006, Neutrik® already complied with these requirements laid down therein and stopped using lead in the soldering process at the end of 2004. In addition Neutrik® conforms to the following EU Directives and regulations:

- EU 76/769/EEC
- EU 2000/53/EC
- EU 2002/95/EC (RoHS)
- EU 2002/96/EC (WEEE)
- Sony Technical Standard SS-00259 (Sony Green Partner)

## Neutrik® Part Number Guide

### NC3FAH1-B-0-D

|                            |                             |  |
|----------------------------|-----------------------------|--|
| <b>Packaging:</b>          | <b>D</b>                    | Cable connector: Bulk packed                                       |
|                            | <b>D</b>                    | Chassis connector: Disassembled Push latch                         |
| <b>Assembly:</b>           | <b>w/o</b>                  | Latch Lock   |
|                            | <b>-0</b>                   | Retention Spring   |
| <b>Retention:</b>          | <b>B</b>                    | Black shell, gold contacts   |
|                            | <b>BAG</b>                  | Black shell, silver contacts                                       |
| <b>Shell:</b>              | <b>0</b>                    | Separate ground contact connected to shell, male only              |
|                            | <b>1</b>                    | Pin 1 & Panel & Shell connected, no separate ground contact        |
|                            | <b>2</b>                    | Separate ground contact connected to shell & panel, separate Pin 1 |
|                            | <b>E</b>                    | Additional ground contacts   |
|                            | <b>w/o number</b>           | No ground / Shell contact (except 4 / 5 pole), female only         |
| <b>Grounding:</b>          | <b>H</b>                    | Horizontal PCB mount   |
|                            | <b>HL</b>                   | Lateral left PCB mount   |
|                            | <b>HR</b>                   | Lateral right PCB mount  |
|                            | <b>L</b>                    | Solder Cups  |
|                            | <b>V</b>                    | Verticale PCB mount  |
|                            | <b>Y</b>                    | IDC for wires (no ground)  |
|                            | <b>M3</b>                   | Mounting holes with M3 thread                                      |
|                            | <b>M25</b>                  | Mounting holes with M2.5 thread                                    |
|                            | <b>-</b>                    | Not applicable   |
|                            | <b>Series:</b>              | <b>A, AA, B, BA, D, DL, DLX, MPR, P, PX, RX, X, XX</b>             |
| <b>Termination:</b>        | <b>F</b>                    | Female   |
|                            | <b>M</b>                    | Male   |
| <b>Gender:</b>             | <b>3, 4, 5, 6, 7, 8, 12</b> |  |
| <b>Number of Contacts:</b> | <b>3, 4, 5, 6, 7, 8, 12</b> |  |
| <b>Connector Type:</b>     | <b>A</b>                    | Adapter  |
|                            | <b>AC</b>                   | PowerCon®  |
|                            | <b>B</b>                    | BNC  |
|                            | <b>C</b>                    | XLR  |
|                            | <b>D</b>                    | Dummy Plug   |
|                            | <b>E</b>                    | RJ45   |
|                            | <b>F</b>                    | RCA / CINCH  |
|                            | <b>J (MJ, RJ, SJ)</b>       | Jack   |
|                            | <b>K</b>                    | Cable Assemblies   |
|                            | <b>L</b>                    | Loudspeaker  |
|                            | <b>M</b>                    | Modules  |
|                            | <b>O</b>                    | Fiber Connector  |
|                            | <b>P</b>                    | Plugs  |
|                            | <b>PP</b>                   | Patch Panel  |
|                            | <b>R</b>                    | Circular Connector   |
|                            | <b>T</b>                    | Transformer  |



## XLR Connectors

## Content

## Page

|                            |    |  |    |
|----------------------------|----|--|----|
| Cable Connectors:          |    | Receptacles:   |    |
| XX Series .....            | 9  | A Series .....   | 17 |
| EMC-XLR Series .....       | 9  | AA Series .....  | 17 |
| RX Series .....            | 10 | B Series .....   | 18 |
| XX-HE .....                | 10 | BA Series .....  | 18 |
| XX-14 Serie .....          | 11 | A/B Series 5 pole switch .....   | 19 |
| XX Crimp Series .....      | 11 | D Series .....   | 19 |
| XX Crystal Series .....    | 12 | DL Series .....  | 20 |
| ConvertCon .....           | 12 | DLX Series .....   | 20 |
| X Series .....             | 13 | DLX Crimp Series .....   | 21 |
| X-HD Series .....          | 13 | EMC Series .....   | 21 |
| XCC Series .....           | 14 | MPR-HD Series .....  | 22 |
| FXS Series .....           | 14 | Feedthrough .....  | 22 |
| FX-SPEC Series .....       | 14 | P Series .....   | 23 |
| Technical Data .....       | 15 | Combo Series .....   | 23 |
| Ordering Information ..... | 16 | Combo A Series .....   | 24 |
|                            |    | Accessories .....  | 25 |
|                            |    | Technical Data .....   | 26 |
|                            |    | Ordering Information A/AA Series .....   | 27 |
|                            |    | Ordering Information B/BA Series .....   | 28 |
|                            |    | Ordering Information D/DL/DLX/DLX Crimp/EMX/P/<br>MPR-HD /Combo / Combo A Series ..... | 29 |
|                            |    | Panel Cutouts, Assembly Tools .....  | 30 |

## Introduction

The XLR connector series is probably together with the Speakon® series Neutrik's most known product range and has been due to the simple but striking concept one of the most important keys to our great success.

We introduced the first XLR version more than 25 years ago, meanwhile it became the worldwide accepted standard.

XLR connectors are widely used in various applications of the audio and lighting world. Whether microphone connectors, lighting DMX connectors or any other type of sound equipment, the XLR is ubiquitous throughout the entertainment industry.

Key features are:

- Reliable and robust
- Easy to assemble, simple to use
- Excellent cable protection and retention
- Colour coding
- Available in 3 to 7 pole

Our commitment to design and manufacture real world connectors solutions for the entertainment industry has made us the undisputed world leader in XLR connectors.





# XLR Cable Connectors



Ergonomic latch design



Neutrik hologram



Inside view



Circumferential ground shield contact

## XX Series



NC3FXX



NC6MXX-B

- The next generation of the worldwide accepted standard
- Unique cage type female contact - increases conductivity
- Female contact with "solder stop" for ease soldering
- Male connector without locking "window" - more robust housing, increases durability
- Improved chuck type strain relief - increases retention force and makes assembly easier and faster
- New ground contact - excellent contact integrity between chassis and cable connector
- Customized branding using translucent ring
- Sleek and ergonomic design - valuable and handy
- Unique hologram – guarantees genuineness and protects against counterfeits
- Internal thread on shell is well protected against any damage.

### NC\*FXX

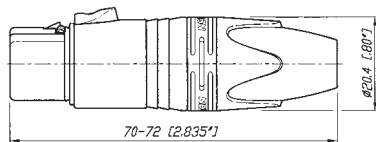

### NC\*MXX

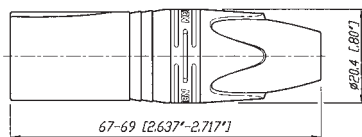

\* ... 3 - 7 contacts

## EMC-XLR Series



NC3FXX-EMC



NC3MXX-EMC

- 3-pole male / female XLR cable connector with integrated capacitive shield to shell connection to avoid RF-interference and LF-noise
- 360° shield contact on female connector ensures best possible shielding and chassis contact
- Patent pending

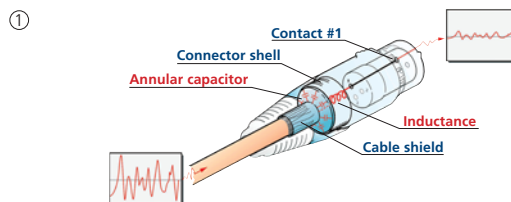

- ① Design guarantees a continuous RF-shield connection but avoids ground loops (no LF-shield connection)
- ② Circular capacitor enables low-inductive shield connection to connector housing
- ③ Cable shield - PIN 1 connection includes EMI suppression bead (blocks high frequencies)

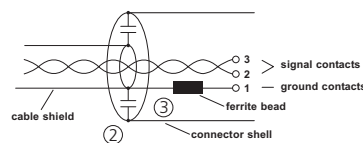

# XLR Cable Connectors



Right angle male connector



High temperature resistant insulator



Velour chromium housing

## RX Series



NC3FRX-BAG



Outlet position

- Right angle version of the XX Series - only 20 mm wide
- Extra slim right-angle connector
- Neutrik chuck type strain relief
- 5 selectable cable outlet positions

## XX-HE Series



NC3FXX-HE



NC3MXX-HE

- Exclusive version of standard XX Series
- Valuable velour chromium plating
- Extra high temperature resistant insulator material
- Machined female contacts
- Flammability UL 94V-0

### NC\*FRX



### NC\*MRX



\* ... 3 - 7 contacts

### NC3FXX-HE



### NC3MXX-HE





Large cable outlet

## XX-14 Series

**NEW**



NC3FXX-14

NC3MXX-14-BAG

- 3 pin XX Series with extra large boot
- Accommodates cable O.D. up to 9.6 mm
- Available in bulk pack only

## XX Crimp Series

**NEW**



NC3FXX-BAG-HA

NC3MXX-HA

- 3 pin XX Series with crimp contacts
- Accommodates wire size AWG 26 - 23 or 0.14 – 0.25 mm<sup>2</sup>
- Utilize standard B-type crimp tool (acc. IEC 60352-2)
- Absolute leadfree and solderless connection:
  - RoHs compliance
  - health and eco-friendly
- Fast and easy assembly
- Gas-tight connection offers a constant contact resistance
- Ideal solution for field and on-site termination

NC3FXX-14

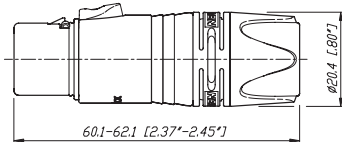

NC3MXX-14



NC3FXX-HA



NC3MXX-HA



# XLR Cable Connectors

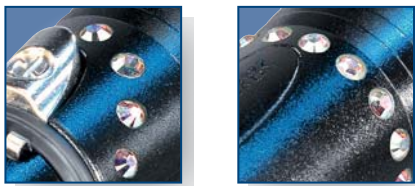

Crystal stones



ConvertCon male - female

## XX Crystal XLR

**NEW**



NC3FXX-B-CRYSTAL



NC3MXX-B-CRYSTAL

- XLR XX Series made with CRYSTALLIZED™ – Swarovski Elements
- Fancy, noble, valuable, attractive package - an eye-catcher

## ConvertCon

**NEW**



NC3FM-C-B



NC3FM-C

- World's first unisex XLR
- Male and female cable connector in one housing
- Easy selectable gender – converted by sliding housing back and forth
- Substitute adapters, ideal as an emergency kit



Convert male - female and vice versa

NC3FXX-B-CRYSTAL

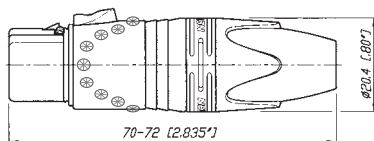

NC3MXX-B-CRYSTAL

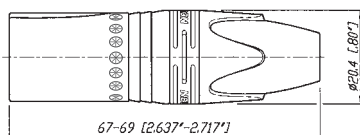

NC3FM-C: Position Female

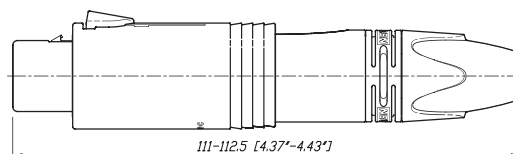

NC3FM-C: Position Male

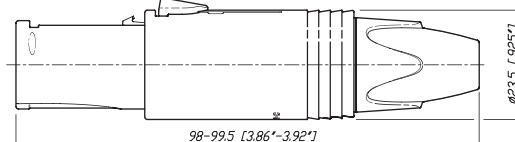

# XLR Cable Connectors

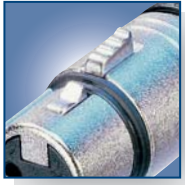

Female locking



Male metal locking window



Rubber sealing protection



Metal bushing

## X Series



NC3FX



NC3MX + BSX-5

- The worldwide accepted XLR connector standard
- Rugged diecast shell
- Compact design (shortest available XLR cable connector)
- Time saving assembly – 4 parts only, no screws
- Neutrik unique chuck type strain relief
- Gold or silver plated contacts
-  UL Recognized components
- Available in 3 - 7 pin configuration

## X-HD Series



NC5FX-HD



NC4MX-HD

- "Heavy duty" cable connectors for outdoor use
- All metal design, male stainless steel
- NC\*FX-HD mates with NC\*MPR-HD chassis connector and NC\*MX-HD
- Dust and water protected according IP 65 in mated condition
- Available in 3 - 5 pin configuration
- Metal bushing including O-ring

### NC\*FX

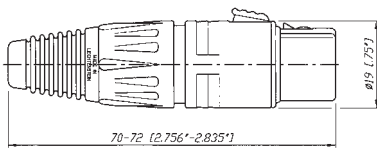

### NC\*MX

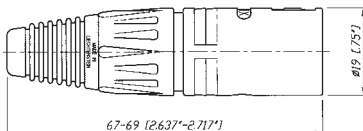

\* ... 3 - 7 contacts

### NC\*FX-HD

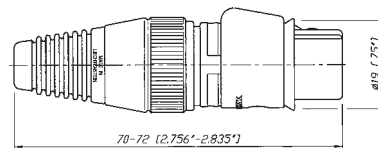

### NC\*MX-HD

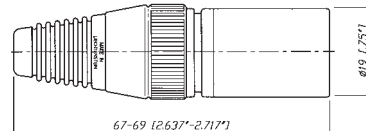

\* ... 3 - 5 contacts

# XLR Cable Connectors



Coding ring



Switch activating ring



Locking ring

## XCC Series



NC3FXCC

- 3 pole cable connector with a circumferential shield contact for best EMI protection
- Featuring a coaxial ground spring and coaxial hex crimp ferrule at the cable entrance for proper and reliable transition of the cable shield to the shell
- Zebra coding ring to indicate digital AES signals included

## FXS Series



NC3FXS

- FX connector with noiseless ON-OFF switch short-circuiting contacts 2 + 3
- For use on a microphone without switch

## FX-SPEC Series



NC3FX-SPEC

- Solid female cable connector with locking ring for highest security of connection
- Uninterrupted EMI protection
- Protects against accidental disconnects
- Thief-proof, grub screw secure connector onto microphone or gooseneck
- Eliminates movement and noise

NC3FXCC



NC3FXS



NC3FX-SPEC

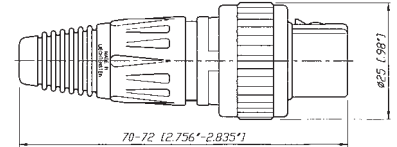

NC3MXCC



# Technical Data

| Specification                       |   | XX & XX-14 & CRYSTAL | EMC Series | X Series | XCC Series   | X-HD Series | FXS Series | XX-HE Series | FX-SPEC Series | RX Series | XX Crimp Series | Convert-Con Series |
|-------------------------------------|---|----------------------|------------|----------|--------------|-------------|------------|--------------|----------------|-----------|-----------------|--------------------|
| <b>Electrical</b>                   |   |                      |            |          |              |             |            |              |                |           |                 |                    |
| Number of contacts                  |   | 3 - 7 <sup>1)</sup>  | 3          | 3 - 7    | 3            | 3 - 5       | 3          | 3            | 3              | 3 - 7     | 3               | 3                  |
| Contact resistance                  | ≤ 3 mΩ  | ●                    | ●          | ●        | ●            | ●           | ●          | ●            | ●              | ●         | ●               | ●                  |
| Insulation resistance               | - initial:                                    | ●                    | ●          | ●        | ●            | ●           | ●          | ●            | ●              | ●         | ●               | ●                  |
|                                     | - after damp heat test:                       | ●                    | ●          | ●        | ●            | ●           | ●          | ●            | ●              | ●         | ●               | ●                  |
| Dielectric strength                 | 1500 V dc                                     | ●                    | ●          | ●        | ●            | ●           | ●          | ●            | ●              | ●         | ●               | ●                  |
| Cable shield-shell connection       | choosable                                     | ●                    | -          | ●        | -            | ●           | -          | ●            | ●              | ●         | ●               | ●                  |
|                                     | determined                                    | -                    | capacitive | -        | crimp        | -           | -          | -            | -              | -         | -               | -                  |
| Shielding effectiveness             | > 55 dB @ 1.3 GHz                             | -                    | ●          | -        | ●            | -           | -          | -            | -              | -         | -               | -                  |
| Lossy ferrite bead on PIN 1         |   | -                    | ●          | -        | -            | -           | -          | -            | -              | -         | -               | -                  |
| Rated current per contact @ 35°C    |   |                      |            |          |              |             |            |              |                |           |                 |                    |
|                                     | 3 pole: 16 A                                  | ●                    | 5 A        | ●        | ●            | ●           | ●          | ●            | ●              | ●         | 1 A             | ●                  |
|                                     | 4 pole: 10 A                                  | ●                    | -          | ●        | -            | ●           | -          | -            | -              | ●         | -               | -                  |
|                                     | 5, 6 pole: 7.5 A                              | ●                    | -          | ●        | -            | ●           | -          | -            | -              | ●         | -               | -                  |
|                                     | 7 pole: 5 A                                   | ●                    | -          | ●        | -            | -           | -          | -            | -              | ●         | -               | -                  |
| Capacitance between contacts        |   |                      |            |          |              |             |            |              |                |           |                 |                    |
|                                     | 3 pole: ≤ 4 pF                                | ●                    | ●          | ●        | ●            | ●           | ●          | ●            | ●              | ●         | ●               | ●                  |
|                                     | 4, 5, 6 pole: ≤ 7 pF                          | ●                    | -          | ●        | -            | ●           | -          | -            | -              | ●         | -               | -                  |
|                                     | 7 pole: ≤ 9 pF                                | ●                    | -          | ●        | -            | -           | -          | -            | -              | ●         | -               | -                  |
| Rated Voltage                       | 50 V ac                                       | ●                    | ●          | ●        | ●            | ●           | ●          | ●            | ●              | ●         | ●               | ●                  |
| <b>Mechanical</b>                   |   |                      |            |          |              |             |            |              |                |           |                 |                    |
| Lifetime > 1'000 cycles             |   | ●                    | ●          | ●        | ●            | ●           | ●          | ●            | ●              | ●         | ●               | ●                  |
| Insertion / withdrawal force ≤ 20 N |   | ●                    | ●          | ●        | ●            | ●           | ●          | ●            | ●              | ●         | ●               | ●                  |
| Cable O.D. range                    | 3.5 - 8.0 mm                                  | ● <sup>2)</sup>      | ●          | ●        | 5.4 - 6.2 mm | ●           | ●          | ●            | ●              | ●         | ●               | ●                  |
| Max. wire size                      | 3 pole: 2.5 mm <sup>2</sup> / AWG 14          | ●                    | AWG 20     | ●        | ●            | ●           | ●          | ●            | ●              | ●         | -               | ●                  |
|                                     | 4 pole: 1.5 mm <sup>2</sup> / AWG 16          | ●                    | -          | ●        | -            | ●           | -          | -            | ●              | ●         | -               | -                  |
|                                     | 5, 6, 7 pole: 1.0 mm <sup>2</sup> / AWG 18    | ●                    | -          | ●        | -            | ●           | -          | -            | -              | ●         | -               | -                  |
| Crimp tool:                         | 6.5 mm Hex die (size "E" acc. to IEC 60803)   | -                    | -          | -        | ●            | -           | -          | -            | -              | -         | B-crimp         | -                  |
| Crimp XX:                           | 0.14 - 0.25 mm <sup>2</sup> / AWG 26 - 23     | -                    | -          | -        | -            | -           | -          | -            | -              | -         | ●               | -                  |
| <b>Material</b>                     |   |                      |            |          |              |             |            |              |                |           |                 |                    |
| Shell                               | Zinc diecast (ZnAl4Cu1)                       | ●                    | ●          | ●        | ●            | -           | ●          | ●            | ●              | ●         | ●               | ●                  |
|                                     | (gal Ni or black Cr)                          | ●                    | gal Ni     | -        | ●            | -           | ●          | velour Cr    | ●              | ●         | ●               | ●                  |
|                                     | Stainless steel                               | -                    | -          | -        | -            | ●           | -          | -            | -              | -         | -               | -                  |
| Insert                              | Polyamide PA 6.6 30% GR                       | ●                    | ●          | ●        | ●            | ●           | ●          | ●            | ●              | ●         | ●               | ●                  |
| Contacts                            | - female 3 pole: Bronze (CuSn8)               | ●                    | ●          | ●        | ●            | ●           | ●          | ●            | ●              | ●         | ●               | ●                  |
|                                     | - female 4 - 7 pole & male: Brass (CuZn39Pb3) | ●                    | ●          | ●        | ●            | ●           | -          | ●            | -              | ●         | -               | -                  |
| Contact surface                     | Silver gal 2 μm Ag                            | ●                    | Au         | ●        | ●            | Au          | ●          | ●            | Au             | ●         | ●               | ●                  |
|                                     | or Gold gal 0.2 μm Au hard alloy over 2 μm Ni | -                    | -          | -        | -            | -           | -          | -            | -              | -         | -               | -                  |
| Latch lock                          | St3K32 (latch) / Ck 67 (spring)               | -                    | -          | ●        | ●            | ●           | ●          | -            | ●              | -         | -               | -                  |
|                                     | Zinc diecast (ZnAl4Cu1)                       | ●                    | ●          | -        | -            | -           | -          | ●            | -              | ●         | ●               | ●                  |
| Strain-relief clamp                 | POM   | ●                    | ●          | ●        | ●            | ●           | ●          | ●            | ●              | ●         | ●               | ●                  |
| Bushing                             | PA / PU                                       | ●                    | ●          | ●        | ●            | PU          | PU         | ●            | ●              | ●         | ●               | ●                  |
| Circumferential ground spring       | Bronze (CuSn6), Ni plated                     | -                    | ●          | -        | ●            | -           | -          | -            | -              | -         | -               | -                  |
| Crimp ferrule                       | Brass (CuZn39Pb3), Ni plated                  | -                    | -          | -        | ●            | -           | -          | -            | -              | -         | -               | -                  |
| Coding ring                         | Polyamide PA 6 15% GR                         | -                    | -          | -        | ●            | -           | -          | -            | -              | -         | -               | -                  |
| Sealing jacket                      | EPDM  | -                    | -          | -        | -            | ●           | -          | -            | -              | -         | -               | -                  |
| Securing ring                       | Brass (CuZn39Pb3)                             | -                    | -          | -        | -            | -           | -          | -            | ●              | -         | -               | -                  |
| <b>Environmental</b>                |   |                      |            |          |              |             |            |              |                |           |                 |                    |
| Operating temperature               | -30°C to +80°C                                | ●                    | ●          | ●        | ●            | ●           | ●          | ●            | ●              | ●         | ●               | ●                  |
| Flammability                        | UL 94 HB                                      | ●                    | ●          | ●        | ●            | ●           | ●          | V-0          | ●              | ●         | ●               | ●                  |
| Protection class                    | IP 40   | ●                    | ●          | ●        | ●            | IP 65       | ●          | ●            | ●              | ●         | ●               | ●                  |
| Solderability complies with IEC     | 68-2-20                                       | ●                    | ●          | ●        | ●            | ●           | ●          | ●            | ●              | ●         | ●               | ●                  |
| Manufacturing Standard IEC          | 61076-2-103                                   | ●                    | ●          | ●        | ●            | ●           | ●          | ●            | ●              | ●         | ●               | ●                  |

XX-14, CRYSTAL: <sup>1)</sup> ... 3 pole <sup>2)</sup> ... Cable O.D. max. 9.6mm

## Ordering Information for Cable Connectors

| Female                   | Male                     | Shell             | Contact - plating | 3 pole | 4 pole | 5 pole | 6 pole | 7 pole |
|--------------------------|--------------------------|-------------------|-------------------|--------|--------|--------|--------|--------|
| <b>XX Series</b>         |                          |                   |                   |        |        |        |        |        |
| NC*FXX                   | NC*MXX                   | Nickel            | Silver            | ●      | ●      | ●      | ●      | ●      |
| NC*FXX-B                 | NC*MXX-B                 | Black Cr          | Gold              | ●      | ●      | ●      | ●      | ●      |
| NC*FXX-BAG               | NC*MXX-BAG               | Black Cr          | Silver            | ●      | ●      | ●      | ●      | ●      |
| NC3FXX-**-D <sup>1</sup> | NC3MXX-**-D <sup>1</sup> | Nickel / Black Cr | Silver / Gold     | ●      | -      | -      | -      | -      |
| NC6FSXX <sup>2</sup>     | NC6MSXX <sup>2</sup>     | Nickel            | Silver            | -      | -      | -      | ●      | -      |
| NC6FSXX-B <sup>2</sup>   | NC6MSXX-B <sup>2</sup>   | Black Cr          | Gold              | -      | -      | -      | ●      | -      |
| NC6FSXX-BAG <sup>2</sup> | NC6MSXX-BAG <sup>2</sup> | Black Cr          | Silver            | -      | -      | -      | ●      | -      |
| <b>XX-EMC Series</b>     |                          |                   |                   |        |        |        |        |        |
| NC3FXX-EMC               | NC3MXX-EMC               | Nickel            | Gold              | ●      | -      | -      | -      | -      |
| NC3FXX-EMC-B             | -                        | Black Cr          | Gold              | ●      | -      | -      | -      | -      |
| <b>RX Series</b>         |                          |                   |                   |        |        |        |        |        |
| NC*FRX                   | NC*MRX                   | Nickel            | Silver            | ●      | ●      | ●      | ●      | ●      |
| NC*FRX-B                 | NC*MRX-B                 | Black Cr          | Gold              | ●      | ●      | ●      | ●      | ●      |
| NC*FRX-BAG               | NC*MRX-BAG               | Black Cr          | Silver            | ●      | ●      | ●      | ●      | ●      |
| <b>XX-HE Series</b>      |                          |                   |                   |        |        |        |        |        |
| NC3FXX-HE                | NC3MXX-HE                | Velour Chromium   | Gold              | ●      | -      | -      | -      | -      |
| <b>XX-14 Series</b>      |                          |                   |                   |        |        |        |        |        |
| NC3FXX-14-D              | NC3MXX-14-D              | Nickel            | Silver            | ●      | -      | -      | -      | -      |
| NC3FXX-14-B-D            | NC3MXX-14-B-D            | Black Cr          | Gold              | ●      | -      | -      | -      | -      |
| NC3FXX-14-BAG-D          | NC3MXX-14-BAG-D          | Black Cr          | Silver            | ●      | -      | -      | -      | -      |
| <b>XX Crimp Series</b>   |                          |                   |                   |        |        |        |        |        |
| NC3FXX-HA                | NC3MXX-HA                | Nickel            | Gold              | ●      | -      | -      | -      | -      |
| NC3FXX-HA-BAG            | NC3MXX-HA-BAG            | Black Cr          | Silver            | ●      | -      | -      | -      | -      |
| <b>ConvertCon Series</b> |                          |                   |                   |        |        |        |        |        |
|                          | NC3FM-C                  | Nickel            | Gold              | ●      | -      | -      | -      | -      |
|                          | NC3FM-C-B                | Black Cr          | Gold              | ●      | -      | -      | -      | -      |
| <b>Crystal XLR</b>       |                          |                   |                   |        |        |        |        |        |
| NC3FXX-B-CRYSTAL         | NC3MXX-B-CRYSTAL         | Black Cr          | Gold              | ●      | -      | -      | -      | -      |
| <b>X Series</b>          |                          |                   |                   |        |        |        |        |        |
| NC*FX                    | NC*MX                    | Nickel            | Silver            | ●      | ●      | ●      | ●      | ●      |
| NC*FX-B                  | NC*MX-B                  | Black Cr          | Gold              | ●      | ●      | ●      | ●      | ●      |
| NC*FX-BAG                | NC*MX-BAG                | Black Cr          | Silver            | ●      | ●      | ●      | ●      | ●      |
| NC3FX-**-D <sup>1</sup>  | NC3MX-**-D <sup>1</sup>  | Nickel / Black Cr | Silver / Gold     | ●      | -      | -      | -      | -      |
| NC6FSX <sup>2</sup>      | NC6MSX <sup>2</sup>      | Nickel            | Silver            | -      | -      | -      | ●      | -      |
| NC6FSX-B <sup>2</sup>    | NC6MSX-B <sup>2</sup>    | Black Cr          | Gold              | -      | -      | -      | ●      | -      |
| NC6FSX-BAG <sup>2</sup>  | NC6MSX-BAG <sup>2</sup>  | Black Cr          | Silver            | -      | -      | -      | ●      | -      |
| <b>X-HD Series</b>       |                          |                   |                   |        |        |        |        |        |
| NC*FX-HD                 | NC*MX-HD                 | Nickel            | Gold              | ●      | ●      | ●      | -      | -      |
| NC3FX-HD-B               | NC3MX-HD-B               | Metal Black       | Gold              | ●      | -      | -      | -      | -      |
| <b>XCC Series</b>        |                          |                   |                   |        |        |        |        |        |
| NC3FXCC                  | NC3MXCC                  | Nickel            | Gold              | ●      | -      | -      | -      | -      |
| <b>FXS Series</b>        |                          |                   |                   |        |        |        |        |        |
| NC3FXS                   | -                        | Nickel            | Gold              | ●      | -      | -      | -      | -      |
| NC3FXS-B                 | -                        | Black Cr          | Gold              | ●      | -      | -      | -      | -      |
| <b>FX-SPEC Series</b>    |                          |                   |                   |        |        |        |        |        |
| NC3FX-SPEC               | -                        | Black Cr          | Gold              | ●      | -      | -      | -      | -      |

Detailed information on page 21 and 26.

\* ..... Number of Contacts

\*\* ..... Nickel or Black

-D<sup>1</sup> .... Bulk packed, to be ordered in multiples of 100 pcs.

<sup>2</sup> ..... Switchcraft Equivalent





# XLR Chassis Connectors



Colored coding ring



Lateral right PCB mount



Locking release tab



Ground contact tab

## A Series



NC3FAH-0



NC3MAV

- Smallest XLR receptacles, highest packing density
- Plastic housing, steel retention lug
- Various grounding options
- "Tulip" type female contact design with high contact pressure
- Selective gold plated contact and PCB termination area for best conductivity and solderability
- Plastic housing flammability UL 94V-0

## AA Series



NC3FAAV2



NC3MAAH-1

- Front panel cutout and PCB layout 100% compatible to the A Series
- Most cost-effective series
- "Tulip" type female contact design with high contact pressure
- Selective gold plated contact and PCB termination area for best conductivity and solderability
- Plastic housing flammability UL 94 HB

NC5FAV

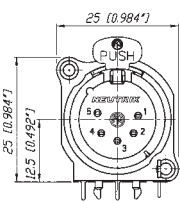

NC5FAH

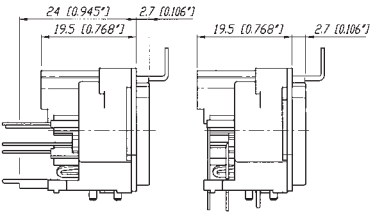

NC3MAV-0

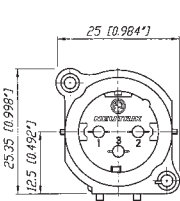

NC5MAH

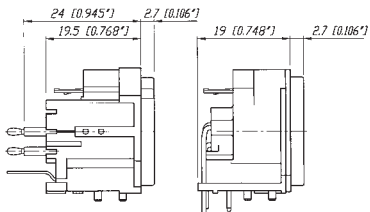

NC3FAAH

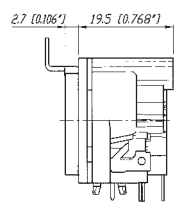

NC3FAAV-0

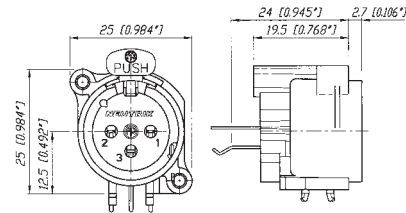

### Grounding Options (A / AA / B / BA Series):

Female:

- 1 ... Pin 1 & Panel & Shell connected, no separate ground contact
  - 2 ... Separate ground contact connected to shell & panel, separate Pin 1
- w/o number: No ground / Shell contact (except 4 / 5 pole)

Male:

- w/o number: Separate ground contact connected to shell & panel, separate Pin 1
- 0 ... Separate ground contact, connected to shell, separate Pin 1
  - 1 ... Pin 1 & Panel & Shell connected, no separate ground contact

# XLR Chassis Connectors



Circumferential metal ring



Front panel grounding



Tear drop contact design

## B Series



NC3FBV



NC3MBV

- Same as A Series with exception of a metal mounting flange enabling continuous circumferential ground contact to chassis for best EMC and RF protection
- Fastening with B-screw

## BA Series



NC3FBAV2



NC3MBAH

- More economical version of B Series with modified metal flange
- Fastening with A-screw
- 3, 4 and 5 pole version

NC3FBY



NC3FBH1

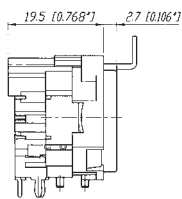
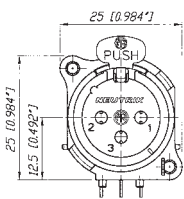

NC3FBAV

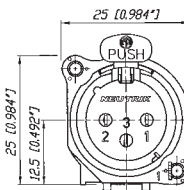
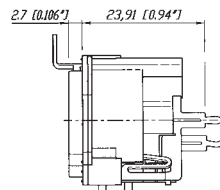

NC3FBAH

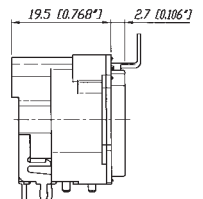

NC3MBH

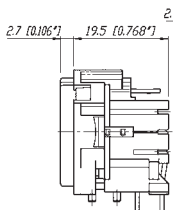

NC3MBV

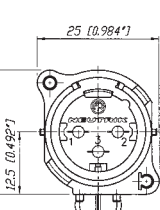
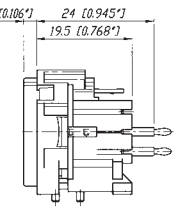

NC3MBAV

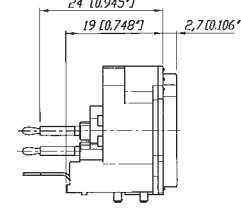
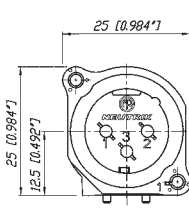

NC3MBAH

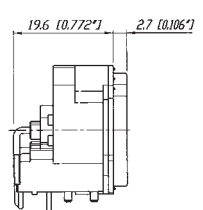



Incorporated switch



Insert removable



## A/B Series 5-pole switch



NC5FAV-SW



NC5MAV-SW

- A and B Series 5 pole connector with additional switch
- Normally open, normally closed (NO - NC) contact
- Switch activated by mating XLR cable connector
- Available in 5 pole, 3 or 4 pole on request

Inserting (Schematic):



NC5FAV-SW



NC5MBV-SW



## D Series



NC3FD-H



NC3MD-V

- "D" Shape metal shell
- Optimal RF protection using 3 shield contacts
- Horizontal and vertical PCB mount with separate ground contact
- Mounting holes with M3 threads available
- 2 piece connector, insert is removable from shell
- Front locked / unlocked insert
- Special version with screw termination

NC3FD-V / NC3FD-H

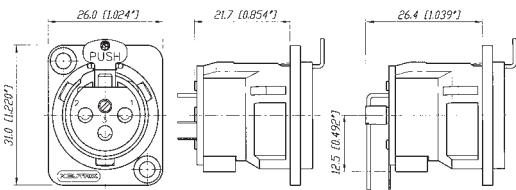

NC3MD-V / NC3MD-H

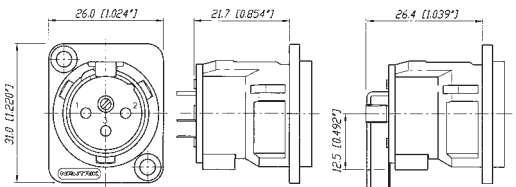



Locking release tab



Horizontal PCB mount



Ground shielding

## DL Series



NC3FD-L-1



NC4MDM3-H



NC3FD-LX-HE



NC5MD-LX

- Unified "D" metal shell
- Solder cups on 3 - 7 pole version
- Additional PCB mount on 4 and 5 pole
- Front and rear mountable
- High End "-HE" version available with machined female contacts, temperature resistant insulator and valuable velour chromium plating

NC3FD-L-1

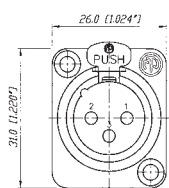

NC\*FDM3-H

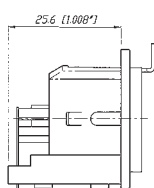
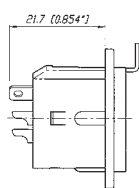

NC3MD-L-1

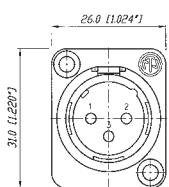

NC\*MDM3-H

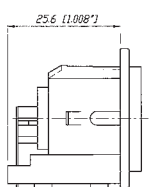
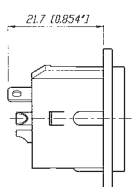

\* ... 3 - 5 contacts

## DLX Series

- Next generation of the popular DL Series with greater functionality
- All metal housing works in combination with a new duplex ground contact yielding the best RF protection and ground conductivity in a chassis mount XLR
- Male connector's retention bar replaces plastic design with all metal version
- Unique cage type female contacts on 3 pole version for increased conductivity
- Machined male and female contacts on four to seven pin versions
- D-style housing provides installation compatibility with industry standard D mounting dimensions

NC3FD-LX



NC\*MD-LX

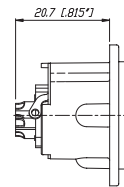

\* ... 3 - 7 contacts





Crimp type contact



Circumferential ground spring

## DLX Crimp Series

## EMC Series

**NEW**



NC3FD-LX-HA



NC3MD-LX-BAG-HA



NC3FDX-EMC-SPEC

- 3 pole DLX Series with crimp contacts
- Accommodates wire size AWG 26 - 23 or 0.14 – 0.25 mm<sup>2</sup>
- Utilize standard B-type crimp tool (acc. IEC 60352-2)
- Absolute leadfree and solderless connection:
  - RoHs compliance
  - health and eco-friendly
- Fast and easy assembly
- Gas-tight connection offers a constant contact resistance
- Ideal solution for field and on-site termination

- 3 pole female XLR chassis connector with integrated capacitive shield to shell connection to avoid RF-interference and LF-noise
- 360° shield contact on female connector ensures best possible shielding and chassis contact
- D flange chassis for panel mount applications
- Includes the locking nut of the NC3FX-SPEC for secure fastening of a gooseneck for instance
- Special flange for large openings available
- Patent pending

Detailed information of RF-shielding see page 9 - EMC cable-connector.

NC3FD-LX-HA



NC3MD-LX-HA



NC3FDX-EMC-SPEC





Sealing Gasket



Through hole fastening

## MPR-HD Series



NC3MPR-HD



NC5MPR-HD

- IP 65 - in combination with NC\*FX-HD cable connectors
- Perfect for outdoor applications
- Sealing gasket for water tight panel mount
- Gold plated contacts



NC5MPR-HD

NC5FX-HD

NC3MPR-HD

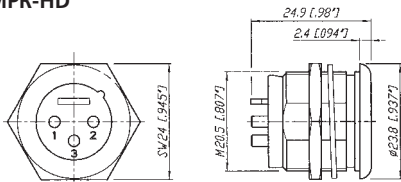

\* ... 3 - 5 contacts

## P Series



NC3FP-1



NC6MP-B

- Smallest available traditional style hard wiring receptacles with large solder cups
- Compatible with Switchcraft DxM, DxM; Cannon XLRx31, XLRx32
- 6 pole version available with Switchcraft contact arrangement (NC6FSP-1, NC6MSP)

NC3FP-1



NC3MP





Front end design



Solder termination

## Combo Series



NCJ9FI-V



NCJ10FI-S

- Combined XLR receptacle and 1/4" phone jack
- Attractive "front end" design
- Saves rack space by combining 2 connectors in one housing
- Horizontal or vertical PCB mounting or hard wire soldering
- Fully normalised
- Stereo or mono version
- Very low conductor capacitance, therefore suitable for digital audio
- Fastening: Self-tapping Plastite® screws with thread 2.9 x 1.06 and tri-rondular configuration (A screw)
- Front dimension: 30 x 27 mm



XLR receptacle or 1/4" phone jack

NCJ10FI-H

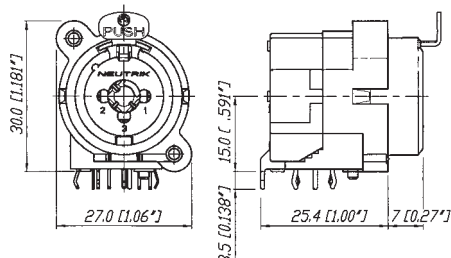



Horizontal PCB mount



Vertical PCB mount



Hologram

## Combo A Series

**NEW**



NCJ6FA-V



NCJ6FA-H-0



NCJ6FA-V-0

- Combined 3 pole XLR receptacle and 1/4" phone jack for balanced mic and line or instrument inputs in one XLR housing
- Dramatic space saving - 15% over the predecessor Combo
- Two connectors in one housing - substantial cost, material and labour saving
- Horizontal and vertical PCB mount available
- 3 pole female XLR combined with stereo TRS jack
- Very low conductor capacitance - ideal for digital audio
- Front panel cut-out compatible with Neutrik XLR A Series
- Branded with unique hologram - guarantees genuine and authentic Neutrik product

NCJ6FA-V

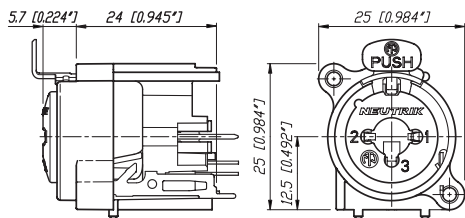

NCJ6FA-H

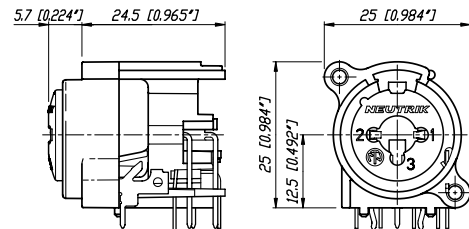



## Colour Coded Accessories

| Part No.                      | Description   | Black | Brown | Red | Orange | Yellow | Green | Blue | Violet | Grey | White |
|-------------------------------|---|-------|-------|-----|--------|--------|-------|------|--------|------|-------|
|                               |   | 0     | 1     | 2   | 3      | 4      | 5     | 6    | 7      | 8    | 9     |
| <b>XLR Cable Connectors</b>   |   |       |       |     |        |        |       |      |        |      |       |
| BSX-*                         | Coloured bushing for X Series                                     |       |       |     |        |        |       |      |        |      |       |
| BXX-*                         | Coloured bushing for XX Series                                    |       |       |     |        |        |       |      |        |      |       |
| XCR-*                         | Coloured coding ring for X Series                                 |       |       |     |        |        |       |      |        |      |       |
| XXR-*                         | Coloured coding ring for XX Series                                |       |       |     |        |        |       |      |        |      |       |
| <b>XLR Chassis Connectors</b> |   |       |       |     |        |        |       |      |        |      |       |
| ACRF-*                        | Coloured ring for female 4 + 5 pole A Series and 3 pole BA Series |       |       |     |        |        |       |      |        |      |       |
| ACRM-*                        | Coloured ring for male 4 + 5 pole A Series and 3 pole BA Series   |       |       |     |        |        |       |      |        |      |       |
| DSS-*                         | Lettering plate for D Series                                      |       |       |     |        |        |       |      |        |      |       |

## Accessories

### XLR Cable Connectors



|        |   |
|--------|---|
| BXX-CR | Bushing with translucent coding ring                |
| XCCR   | Coding ring for X Series digital signals            |
| XXCR   | Translucent coding ring for XX Series for XX Series |

### XLR Chassis Connectors



|             |  |
|-------------|--|
| A-Screw-1-8 | Plastite® screw 2.9 x 8                                |
| B-Screw-1-8 | TAPTITE® screw 2.5 x 8                                 |
| DBA         | Dummy-plate for D Series panel cut outs                |
| FDR1        | Round panel mounting flange for NC3FDX-EMC-SPEC        |
| HA-3FXX     | Set of 50 female spare contacts for crimp XLR          |
| HA-3MXX     | Set of 50 male spare contacts for crimp XLR            |
| MFD         | M3 mounting frame for D-size chassis                   |
| NDF         | Dummy plug for female XLR chassis connector            |
| NDM         | Dummy plug for male XLR chassis connectors             |
| SC*         | Rubber sealing cap for female and male XLR receptacles |



|      |  |
|------|--|
| SCD* | Rubber sealing cover for female and male D Series                                  |
| SCDR | Rear end protection cover for D-size chassis connectors                            |
| SCDX | Hinged cover seals D-size chassis connectors, IP42 rated                           |
| SFAV | Rubber frame for A / B Series to mount between front plate and rear vertical print |

## Specification

A   AA   B   BA   D   DL/DLX   DLX   MPR-HD   P   Combo   A  
Series   Series   Series   Series   Series   Series   Crimp   Series   Series   Series   Combo

### Electrical

|                              |                          |       |   |       |   |   |        |        |        |             |          |         |
|------------------------------|--------------------------|-------|---|-------|---|---|--------|--------|--------|-------------|----------|---------|
| Number of contacts           |                          | 3 - 5 | 3 | 3 - 5 | 3 | 3 | 3 - 7  | 3      | 3 - 5  | 3 - 7 (6**) | 5 - 10   | 3 / 3   |
| Contact resistance           | ≤ 6 mΩ                   | ●     | ● | ●     | ● | ● | ●      | ●      | ●      | ●           | ≤ 10 mΩ  | ≤ 10 mΩ |
| Insulation resistance        | - initial:               | ●     | ● | ●     | ● | ● | ●      | ●      | ●      | ●           | ●        | ●       |
|                              | - after damp heat test:  | ●     | ● | ●     | ● | ● | ●      | ●      | ●      | ●           | > 500 MΩ | ●       |
| Dielectric strength          | 1500 V dc                | ●     | ● | ●     | ● | ● | ●      | ●      | ●      | ●           | ●        | ●       |
| Rated voltage                | 50 V ac                  | ●     | ● | ●     | ● | ● | ●      | ●      | ●      | ●           | ●        | ●       |
| Rated current per contact    | 3 pole: 6 A              | ●     | ● | ●     | ● | ● | 16 A   | 1 A    | 16 A   | 16 A        | -        | 3 A     |
|                              | 4 pole: 6 A              | ●     | - | ●     | - | - | 10 A   | -      | 10 A   | 10 A        | -        | -       |
|                              | 5, 6 pole: 3 A           | ●     | - | ●     | - | - | 7.5 A  | -      | 7.5 A  | 7.5 A       | -        | -       |
|                              | 7 pole: 5 A              | -     | - | -     | - | - | ●      | -      | -      | ●           | -        | -       |
|                              | Combo XLR + Jack contact | 7.5 A | - | -     | - | - | -      | -      | -      | -           | -        | ●       |
| Capacitance between contacts | 3 pole: ≤ 7 pF           | ●     | ● | ●     | ● | - | ≤ 4 pF | ≤ 4 pF | ≤ 4 pF | ≤ 4 pF      | ≤ 2 pF   | ≤ 2 pF  |
|                              | 4, 5, 6 pole: ≤ 7 pF     | ●     | - | ●     | - | - | ●      | -      | ●      | ●           | -        | -       |
|                              | 7 pole: ≤ 9 pF           | -     | - | -     | - | - | ●      | -      | -      | ●           | -        | -       |
|                              |                          |       |   |       |   |   |        |        |        |             |          |         |

### Mechanical

|                              |  |   |   |   |   |   |   |   |   |   |         |         |
|------------------------------|--|---|---|---|---|---|---|---|---|---|---------|---------|
| Lifetime                     | > 1'000 mating cycles                  | ● | ● | ● | ● | ● | ● | ● | ● | ● | ●       | ●       |
| Insertion / withdrawal force | ≤ 20 N                                 | ● | ● | ● | ● | ● | ● | ● | ● | ● | ● 25 N  | ●       |
| Retention method             | - standard: latch lock                 | ● | ● | ● | ● | ● | ● | ● | ● | ● | ● (XLR) | ● (XLR) |
|                              | - "0" Version: ≥ 20 N separating force | ● | ● | ● | ● | ● | ● | ● | ● | ● | ● 25 N  | ● 25 N  |

### Material

|                     |  |                             |   |   |   |   |   |   |   |           |   |   |
|---------------------|--|-----------------------------|---|---|---|---|---|---|---|-----------|---|---|
| Insert              | Polyamide  | PA 6.6 30% GR               | ● | ● | ● | ● | ● | ● | ● | ●         | ● | ● |
| Shell               | Zinc diecast   | ZnAl4Cu1                    | - | - | - | - | ● | ● | ● | ●         | - | - |
|                     |  | (gal Ni or black Cr plated) | - | - | - | - | ● | ● | ● | Ni plated | ● | - |
| Ring                | Zinc diecast   | ZnAl4Cu1                    | - | - | ● | ● | - | - | - | -         | - | - |
| Contacts            | - female   | 3 pole: Bronze CuSn6        | ● | ● | ● | ● | ● | ● | ● | -         | ● | ● |
|                     |  | 4 - 5 pole: Bronze CuSn6    | ● | - | ● | - | - | - | - | -         | - | - |
|                     |  | 4 - 7 pole: Brass CuZn39Pb3 | - | - | - | - | - | ● | - | -         | ● | - |
|                     | - male:  | Brass CuZn35Pb2             | ● | ● | ● | ● | ● | ● | ● | ●         | - | - |
| Contact surface     | gal 0.2 μm AuCo over 2 μm NiP15 (Tribor®)            |                             | ● | ● | ● | ● | - | - | - | -         | ● | ● |
|                     | gal 2 μm Ag or gal 0.2 μm Au hard alloy over 2 μm Ni |                             | - | - | - | - | ● | ● | ● | Au        | ● | - |
| Latch lock & spring |  | Ck 67 steel, treated        | ● | ● | ● | ● | ● | ● | ● | -         | ● | ● |

### Environmental

|                                 |                |        |   |        |       |     |     |     |       |   |   |   |
|---------------------------------|----------------|--------|---|--------|-------|-----|-----|-----|-------|---|---|---|
| Operating temperature           | -30°C to +80°C | ●      | ● | ●      | ●     | ●   | ●   | ●   | ●     | ● | ● | ● |
| Protection class                | IP 40          | ●      | ● | ●      | ●     | ●   | ●   | ●   | IP 65 | ● | ● | ● |
| Flammability                    | UL 94 HB       | ●      | ● | ●      | -     | ●   | ●   | ●   | ●     | ● | ● | ● |
|                                 | UL 94 V-0      | 3 pole | - | 3 pole | ●     | -   | -   | -   | -     | - | - | - |
| Solderability complies with IEC | 68-2-20        | ●      | ● | ●      | ●     | ●   | ●   | ●   | ●     | ● | ● | ● |
| Mounting screw                  |                | A      | A | 1)     | A     | -   | -   | -   | -     | - | A | A |
| Colour coding                   |                | ACR-*  | - | -      | ACR-* | DSS | DSS | DSS | -     | - | - | - |

(4 + 5 pole only)

1) .... B Series 3 pole connectors > B-screw, 4 & 5 pole versions > A-screw

\*\* .... P Series male 3 - 6 pole



## Ordering Information for Receptacles

| Female      | Male      | Shell         | Contact | 3 pole | 4 pole         | 5 pole         | Female     | Male      | Shell         | Contact | 3 pole |  |
|-------------|-----------|---------------|---------|--------|----------------|----------------|------------|-----------|---------------|---------|--------|--|
| A Series    |           |               |         |        |                |                | AA Series  |           |               |         |        |  |
| NC*FAH-D    |           | Black Plastic | Gold    | -      | ● <sup>⓪</sup> | ● <sup>⓪</sup> | NC3FAAH    | NC3MAAH   | Black Plastic | Gold    | ●      |  |
|             | NC*MAH    | Black Plastic | Gold    | ●      | ●              | ●              | NC3FAAH-0  |           | Black Plastic | Gold    | ●      |  |
| NC*FAH-0    |           | Black Plastic | Gold    | ●      | ● <sup>⓪</sup> | ● <sup>⓪</sup> | NC3FAAH1   | NC3MAAH-1 | Black Plastic | Gold    | ●      |  |
|             | NC3MAH-0  | Black Plastic | Gold    | ●      | -              | -              | NC3FAAH1-0 |           | Black Plastic | Gold    | ●      |  |
| NC3FAHL-0   |           | Black Plastic | Gold    | ●      | -              | -              |            | NC3MAAH-0 | Black Plastic | Gold    | ●      |  |
| NC3FAHR-0   |           | Black Plastic | Gold    | ●      | -              | -              | NC3FAAH2   |           | Black Plastic | Gold    | ●      |  |
| NC3FAH1-D   | NC3MAH-1  | Black Plastic | Gold    | ●      | -              | -              | NC3AAH2-0  |           | Black Plastic | Gold    | ●      |  |
| NC3FAH1-0   |           | Black Plastic | Gold    | ●      | -              | -              | NC3FAAV    | NC3MAAV   | Black Plastic | Gold    | ●      |  |
| NC3FAHL1-D  |           | Black Plastic | Gold    | ●      | -              | -              | NC3FAAV-0  |           | Black Plastic | Gold    | ●      |  |
|             | NC3MAHL   | Black Plastic | Gold    | ●      | -              | -              | NC3FAAV1   | NC3MAAV-1 | Black Plastic | Gold    | ●      |  |
| NC3FAHL1-0  |           | Black Plastic | Gold    | ●      | -              | -              | NC3FAAV1-0 |           | Black Plastic | Gold    | ●      |  |
| NC3FAHR1-D  |           | Black Plastic | Gold    | ●      | -              | -              |            | NC3MAAV-0 | Black Plastic | Gold    | ●      |  |
|             | NC3MAHR   | Black Plastic | Gold    | ●      | -              | -              | NC3FAAV2   |           | Black Plastic | Gold    | ●      |  |
| NC3FAHR1-0  |           | Black Plastic | Gold    | ●      | -              | -              | NC3FAAV2-0 |           | Black Plastic | Gold    | ●      |  |
| NC3FAH2-D   |           | Black Plastic | Gold    | ●      | -              | -              |            |           |               |         |        |  |
| NC3FAH2-0   |           | Black Plastic | Gold    | ●      | -              | -              |            |           |               |         |        |  |
| NC3FAHR2-D  |           | Black Plastic | Gold    | ●      | -              | -              |            |           |               |         |        |  |
| NC3FAHR2-0  |           | Black Plastic | Gold    | ●      | -              | -              |            |           |               |         |        |  |
| NC*FAV-D    |           | Black Plastic | Gold    | -      | ● <sup>⓪</sup> | ● <sup>⓪</sup> |            |           |               |         |        |  |
|             | NC*MAV    | Black Plastic | Gold    | ●      | ●              | ●              |            |           |               |         |        |  |
| NC*FAV-0    |           | Black Plastic | Gold    | ●      | ● <sup>⓪</sup> | ● <sup>⓪</sup> |            |           |               |         |        |  |
|             | NC3MAV-0  | Black Plastic | Gold    | ●      | -              | -              |            |           |               |         |        |  |
| NC3FAV1-D   | NC3MAV-1  | Black Plastic | Gold    | ●      | -              | -              |            |           |               |         |        |  |
| NC3FAV1-0   |           | Black Plastic | Gold    | ●      | -              | -              |            |           |               |         |        |  |
| NC3FAV2-D   |           | Black Plastic | Gold    | ●      | -              | -              |            |           |               |         |        |  |
| NC3FAV2-0   |           | Black Plastic | Gold    | ●      | -              | -              |            |           |               |         |        |  |
| NC3FAY-D    | NC3MAY    | Black Plastic | Gold    | ●      | -              | -              |            |           |               |         |        |  |
| NC3FAY-0    |           | Black Plastic | Gold    | ●      | -              | -              |            |           |               |         |        |  |
| NC5FAV-SW-D | NC5MAV-SW | Black Plastic | Gold    | -      | -              | ●              |            |           |               |         |        |  |

A Series - D version come with disassembled Push latch, version with assembled latch omit -D.

AA Series comes with Push Latch assembled.

A / AA Series rear mount only, all PCB mount except Y version = IDC

⓪... Grounding Option "2"

0... Retention Spring

## Grounding Options

### A / AA Series and B / BA Series

#### Female

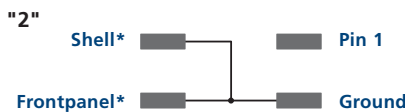

#### Male

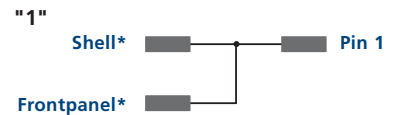
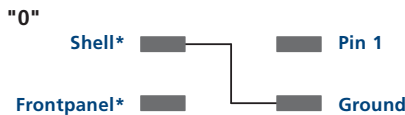
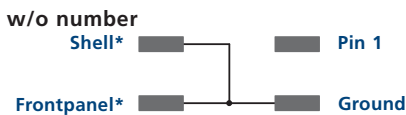

Shell\* ... Contact to shell of mating connector

Frontpanel\* ... Connection to frontpanel by fastening screw

## Ordering Information for Receptacles

| Female      | Male         | Flange      | Contact | 3 pole | Female     | Male        | Flange    | Contact     | 3 pole | 4 pole | 5 pole |
|-------------|--------------|-------------|---------|--------|------------|-------------|-----------|-------------|--------|--------|--------|
| B Series    |              |             |         |        | BA Series  |             |           |             |        |        |        |
|             | NC*MBH       | Metal       | Gold    | ●      | NC3FBAH1-D |             | Metal     | Gold        | ●      | -      | -      |
|             | NC*MBH-B     | Black Metal | Gold    | ●      |            | NC3MBAH     | Metal     | Gold        | ●      | -      | -      |
|             | NC*MBH-M25   | Black Metal | Gold    | ●      | NC3FBAH1-0 |             | Metal     | Gold        | ●      | -      | -      |
|             | NC*MBH-B-M25 | Black Metal | Gold    | ●      |            | NC3MBAH-0   | Metal     | Gold        | ●      | -      | -      |
| NC3FBH1-D   |              | Metal       | Gold    | ●      | NC3FBAH2-D |             | Metal     | Gold        | ●      | -      | -      |
| NC3FBH1-B-D |              | Black Metal | Gold    | ●      |            | NC3MBAH-1   | Metal     | Gold        | ●      | -      | -      |
| NC3FBH1-M25 |              | Metal       | Gold    | ●      | NC3FBAH2-0 |             | Metal     | Gold        | ●      | -      | -      |
| NC3FBHL1-D  |              | Metal       | Gold    | ●      | NC3FBAV1-D |             | Metal     | Gold        | ●      | -      | -      |
|             | NC3MBHL      | Metal       | Gold    | ●      |            | NC3MBAV     | Metal     | Gold        | ●      | -      | -      |
| NC3FBHR1-D  |              | Metal       | Gold    | ●      |            | NC3MBAV-0   | Metal     | Gold        | ●      | -      | -      |
| NC3FBH2-D   |              | Metal       | Gold    | ●      | NC3FBAV2-D |             | Metal     | Gold        | ●      | -      | -      |
| NC3FBH2-B-D |              | Black Metal | Gold    | ●      |            | NC3MBAV-1   | Metal     | Gold        | ●      | -      | -      |
| NC3FBHR2-D  |              | Metal       | Gold    | ●      | NC3FBAV2-0 |             | Metal     | Gold        | ●      | -      | -      |
|             | NC3MBHR      | Metal       | Gold    | ●      |            | NC*FBH-D    |           | Metal       | Gold   | -      | ● ●    |
|             | NC*MBV       | Metal       | Gold    | ●      |            |             | NC*MBH    | Metal       | Gold   | -      | ● ●    |
|             | NC*MBV-B     | Black Metal | Gold    | ●      |            | NC*FBH-B-D  |           | Black Metal | Gold   | -      | ● ●    |
|             | NC*MBV-M25   | Metal       | Gold    | ●      |            |             | NC*MBH-B  | Black Metal | Gold   | -      | - ●    |
|             | NC*MBV-B-M25 | Metal       | Gold    | ●      |            | NC*FBV-D    |           | Metal       | Gold   | -      | ● ●    |
| NC3FBV1-D   |              | Metal       | Gold    | ●      |            |             | NC*MBV    | Metal       | Gold   | -      | ● ●    |
| NC3FBV1-B-D |              | Black Metal | Gold    | ●      |            | NC*FBV-B-D  |           | Black Metal | Gold   | -      | ● ●    |
| NC3FBV1-M25 |              | Metal       | Gold    | ●      |            |             | NC*MBV-B  | Black Metal | Gold   | -      | - ●    |
| NC3FBV2-D   |              | Metal       | Gold    | ●      |            | NC5FBV-SW-D | NC5MBV-SW | Metal       | Gold   | -      | - ●    |
| NC3FBV2-B-D |              | Black Metal | Gold    | ●      |            |             |           |             |        |        |        |
| NC3FBY-D    | NC3MBY       | Metal       | Gold    | ●      |            |             |           |             |        |        |        |
| NC3FBY-B-D  | NC3MBY-B     | Black Metal | Gold    | ●      |            |             |           |             |        |        |        |
| NC3FBH1-E-D | NC3MBV-E     | Metal       | Gold    | ●      |            |             |           |             |        |        |        |
| NC3FBH2-E-D |              | Metal       | Gold    | ●      |            |             |           |             |        |        |        |
|             | NC3MBH-E     | Metal       | Gold    | ●      |            |             |           |             |        |        |        |

B / BA Series - D version come with disassembled Push latch, version with assembled latch omit -D.

B / BA Series rear mount only, all PCB mount except Y version = IDC



## Ordering Information for Receptacle

Female Male Shell Contact 3 4 5 6 7  
pole pole pole pole pole

### D Series

|                 |               |          |        |   |   |   |   |   |
|-----------------|---------------|----------|--------|---|---|---|---|---|
| NC3FD-V         | NC3MD-V       | Nickel   | Silver | ● | - | - | - | - |
| NC3FD-V-B       | NC3MD-V-B     | Black Cr | Gold   | ● | - | - | - | - |
| NC3FD-V-BAG     | NC3MD-V-BAG   | Black Cr | Silver | ● | - | - | - | - |
| NC3FDM3-V       | NC3MDM3-V     | Nickel   | Silver | ● | - | - | - | - |
| NC3FDM3-V-B     | NC3MDM3-V-B   | Black Cr | Gold   | ● | - | - | - | - |
| NC3FD-H         | NC3MD-H       | Nickel   | Silver | ● | - | - | - | - |
| NC3FD-H-B       | NC3MD-H-B     | Black Cr | Gold   | ● | - | - | - | - |
| NC3FD-H-BAG     | NC3MD-H-BAG   | Black Cr | Silver | ● | - | - | - | - |
| NC3FDM3-H-D     | NC3MDM3-H     | Nickel   | Silver | ● | - | - | - | - |
| NC3FDM3-H-B-D   | NC3MDM3-H-B   | Black Cr | Gold   | ● | - | - | - | - |
| NC3FDM3-H-BAG-D | NC3MDM3-H-BAG | Black Cr | Gold   | ● | - | - | - | - |

### DL Series

|                  |                |           |        |   |   |   |   |   |
|------------------|----------------|-----------|--------|---|---|---|---|---|
| NC*FD-L-1        | NC*MD-L-1      | Nickel    | Silver | ● | ● | ● | ● | ● |
| NC*FD-L-B-1      | NC*MD-L-B-1    | Black Cr  | Gold   | ● | ● | ● | ● | ● |
| NC*FD-L-BAG-1    | NC*MD-L-BAG-1  | Black Cr  | Silver | ● | ● | ● | ● | - |
| NC*FDM3-L-1-D    | NC*MDM3-L-1    | Nickel    | Silver | ● | ● | ● | - | - |
| NC3FDM3L-BAG-1-D | NC3MDM3L-BAG-1 | Black Cr  | Silver | ● | - | - | - | - |
| NC3FD-L-1-HE     | NC3MD-L-1-HE   | Velour Cr | Gold   | ● | - | - | - | - |
| NC*FDM3-H-D      | NC*MDM3-H      | Nickel    | Silver | - | ● | ● | ● | - |
| NC*FDM3-H-B-D    | NC*MDM3-H-B    | Nickel    | Silver | - | ● | ● | ● | - |
| NC*FDM3-H-BAG-D  | NC*MDM3-H-BAG  | Black Cr  | Silver | - | ● | ● | ● | - |
| NC3FD-S-1-B      | NC3MD-S-1-B    | Black Cr  | Silver | ● | - | - | - | - |

### DLX Series

|              |              |           |        |   |   |   |   |   |
|--------------|--------------|-----------|--------|---|---|---|---|---|
| NC*FD-LX     | NC*MD-LX     | Nickel    | Silver | ● | ● | ● | ● | ● |
| NC*FD-LX-B   | NC*MD-LX-B   | Black Cr  | Gold   | ● | ● | ● | ● | ● |
| NC*FD-LX-BAG | NC*MD-LX-BAG | Black Cr  | Silver | ● | ● | ● | - | - |
| NC*FD-LX-M3  | NC*MD-LX-M3  | Nickel    | Silver | ● | ● | ● | - | - |
| NC3FD-LX-HE  | NC3MD-LX-HE  | Velour Cr | Gold   | ● | - | - | - | - |

### DLX Crimp Series

|                 |                 |          |        |   |   |   |   |   |
|-----------------|-----------------|----------|--------|---|---|---|---|---|
| NC3FD-LX-HA     | NC3MD-LX-HA     | Nickel   | Silver | ● | - | - | - | - |
| NC3FD-LX-HA-BAG | NC3MD-LX-HA-BAG | Black Cr | Gold   | ● | - | - | - | - |

### EMC XLR

|                 |          |      |   |   |   |   |   |
|-----------------|----------|------|---|---|---|---|---|
| NC3FDX-EMC-SPEC | Black Cr | Gold | ● | - | - | - | - |
|-----------------|----------|------|---|---|---|---|---|

### Accessories

|       |   |
|-------|---|
| FDR-1 | Black round panel mounting flange with screws for larger panel cut-outs |
|-------|---|

Female Male Shell Contact 3 4 5 6 7  
pole pole pole pole pole

### P Series

|             |           |          |        |   |   |   |   |
|-------------|-----------|----------|--------|---|---|---|---|
| NC*FP-1     | Nickel    | Silver   | ●      | ● | ● | ● | ● |
|             | NC*MP     | Nickel   | Silver | ● | ● | ● | ● |
| NC*FP-B-1   | Black Cr  | Gold     | ●      | ● | ● | ● | ● |
|             | NC*MP-B   | Black Cr | Gold   | ● | ● | ● | ● |
| NC*FP-BAG-1 | Black Cr  | Silver   | ●      | ● | ● | ● | - |
|             | NC*MP-BAG | Black Cr | Silver | ● | ● | ● | - |

### MPR-HD Series

|   |           |        |      |   |   |   |   |   |
|---|-----------|--------|------|---|---|---|---|---|
| - | NC*MPR-HD | Nickel | Gold | ● | ● | ● | - | - |
|---|-----------|--------|------|---|---|---|---|---|

### Combo A Series

|            |               |      |   |   |   |      |      |      |      |
|------------|---------------|------|---|---|---|------|------|------|------|
|            |               |      |   |   |   | 5    | 6    | 9    | 10   |
|            |               |      |   |   |   | pole | pole | pole | pole |
| NCJ6FA-H   | Black plastic | Gold | - | ● | - | -    | -    | -    | -    |
| NCJ6FA-H-0 | Black plastic | Gold | - | ● | - | -    | -    | -    | -    |
| NCJ6FA-V   | Black plastic | Gold | - | ● | - | -    | -    | -    | -    |
| NCJ6FA-V-0 | Black plastic | Gold | - | ● | - | -    | -    | -    | -    |

### Combo Series

|            |               |      |   |   |   |   |   |
|------------|---------------|------|---|---|---|---|---|
| NCJ*FI-H   | Black plastic | Gold | ● | ● | ● | ● | ● |
| NCJ*FI-H-0 | Black plastic | Gold | ● | ● | ● | ● | ● |
| NCJ*FI-S   | Black plastic | Gold | ● | ● | ● | ● | ● |
| NCJ*FI-S-0 | Black plastic | Gold | ● | ● | ● | ● | ● |
| NCJ*FI-V   | Black plastic | Gold | ● | ● | ● | ● | ● |
| NCJ*FI-V-0 | Black plastic | Gold | ● | ● | ● | ● | ● |

### Contact #

|           |   |   |   |   |   |   |    |    |    |   |    |
|-----------|---|---|---|---|---|---|----|----|----|---|----|
|           | 1 | 2 | 3 | T | R | S | TN | RN | SN | G | GN |
| NCJ5FI-*  | x | x | x | x |   | x |    |    |    | x |    |
| NCJ6FI-*  | x | x | x | x | x | x |    |    |    | x |    |
| NCJ9FI-*  | x | x | x | x | x | x | x  | x  | x  | x | x  |
| NCJ10FI-* | x | x | x | x | x | x | x  | x  | x  | x | x  |

## Panel Cutouts

A / AA / B / BA Series    D / DL / DLX Series    P Series Female    P Series Male    Combo    MPR Series



## Assembly Tools

**HTXP** Hand tool to tighten the XX and PX-bushing

**BTXX** Assembly fixture to tightening the XX-bushing



**HX-R-BNC** Crimp tool for XCC Series

**DIE-R-BNC-PT** Crimp die for XCC Series (6.5 mm HEX)



**HX-R-HA** Hand crimp tool incl. dies & locator for Crimp XLR





## Plugs & Jacks

## Content

## Page

|  |    |  |    |
|--|----|--|----|
| Plugs:   |    | Jacks:                                     |    |
| 1/4" Phone Plug - PX Series .....              | 33 | Locking 1/4" Cable and Chassis Jacks ..... | 39 |
| 1/4" Phone Plug - Silent Plug .....            | 34 | 1/4" Vertical Jacks .....                  | 40 |
| 1/4" Phone Plug - Crystal Plug .....           | 35 | M Jacks .....                              | 41 |
| 1/4" Professional Phone Plugs - P Series ..... | 35 | Slim Jacks .....                           | 42 |
| MIL/B-Gauge Type Phone Plugs .....             | 35 | Stacking Jacks .....                       | 43 |
| 0.173" Bantam Type Miniature Plugs .....       | 36 | Technical Data .....                       | 44 |
| 3.5 mm Right-Angle Stereo Plug .....           | 36 | Ordering Information .....                 | 45 |
| Technical Data .....                           | 37 | RCA Series .....                           | 47 |
| Accessories .....                              | 37 | Technical Data .....                       | 48 |
| Ordering Information .....                     | 38 |  |    |

## Introduction

The Neutrik® plug and jack program offers a wide range of professional phone connectors including 1/4", 3.5 mm, MIL/B-gauge style and TT or bantam style plugs. The jack range offers an exceptional "slim" 1/4" PCB jack that is almost 20% smaller than most other designs. The heavy duty M line combines a wide range of options such as three different nose forms and four styles of contacts including 3 PCB and one solder tab. It also includes a 1/4" chassis and cable jack line with the secure locking feature, well known from the XLR range. All jacks are manufactured from strong high-grade thermoplastics and are available in all common versions which make them suitable for audio and industrial applications.

The plug line features:

- Mono (TS) and Stereo (TRS) plugs
- Straight and right-angle versions
- Rugged diecast shell in nickel or black chromium
- Nickel or gold plated contacts
- Chuck type strain relief
- Precision machined plugfinger without rivets
- Coloured boots and rings for coding
- True 3.5 mm stereo plug
- Silent Plug for instrument (guitar) applications

All plugs and jacks are specified to IEC 60603-11 and EIA RS-453 or the respective MIL standard.

Neutrik® also offers a special jack version which is a combined 3 pole XLR receptacle and a 1/4" phone jack for balanced mic or line inputs in one XLR shell. This "one for two" panel mount offers substantial cost, labour and material savings. For more information on the Combo products see page 20 or visit our website at [www.neutrik.com](http://www.neutrik.com).





Neutrik brand



Anti-kink bushing



Chuck type strain relief

## 1/4" Phone Plug - PX and PRX Series



NP2X



NP3X-B



NP3X + PXR-5



NP2RX-B

- Slim 1/4" plug with million fold proven chuck type strain relief
- Precision machined one piece contacts - no rivets
- Sleek attractive design for best handling convenience
- 14.5 mm only in diameter (right angle 15.4 mm) - serves highest packing density of 15.88 mm jack pitch
- Nickel or gold plugfinger in mono (TS) and stereo (TRS)

NP3X

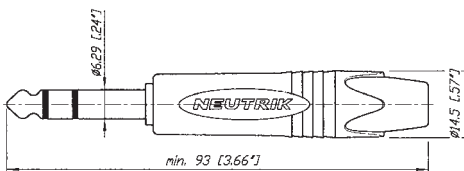

NP2RX

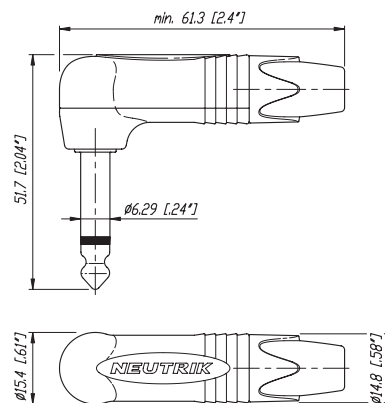

15.88 mm jack pitch:





Moving magnet



Right angle plug

**Attention!**

Use only for instrument (guitar) applications.  
Connecting an amplifier output may blow your amp!

## 1/4" Phone Plug - Silent Plug

**NEW**



NP2X-AU-SILENT



NP2RX-AU-SILENT

- Avoid pops and squeals
- Hermetically sealed switching contacts
- Lifetime beyond 10'000 mating cycles
- Slim right-angle plug with industry proven and reliable chuck type cable strain relief
- Sleek attractive design for convenient handling and connections
- Rubber overlay on straight housing for best shock-protection and reliability

**Detail Silent Switch:**



**REED SWITCH**

- Cannot corrode or pollute
- No wear, constant contact resistance
- Decoupled from switching mechanism

**Design Criteria**

The Silent Plug automatically mutes (shorts) an instrument (guitar) cable to avoid pops and squeals when changing the instrument (guitar) under load.

The integrated silent switch (pat. pending) is based on REED-technology and guarantees a lifetime beyond 10'000 mating cycles.

**NP2X-AU-SILENT**

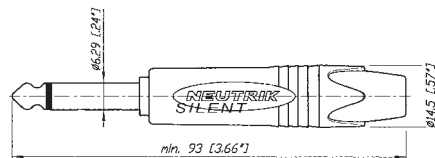

# Plugs



Crystal stones



The standard of professional phone plugs



B-Gauge type

## Crystal Plug

**NEW**



NP2X-B-CRYSTAL

- PX Series made with CRYSTALLIZED™ – Swarovski Elements
- Fancy, noble, valuable, attractive package - an eye-catcher

## 1/4" Professional Plugs



NP2C + BSP-3

- Available in mono (TS) or stereo (TRS)
- Meets EIA / IEC standards
- Unique plug finger design without rivets
- Sturdy diecast metal shell
- Excellent Neutrik® chuck type strain relief

## MIL/B-Gauge Type Plugs



NP3TB-R

NP3CM-B

- 1/4" "B-Gauge" and "MIL" Type Plugs
- All metal design, chuck type strain relief, no rivets
- Meet all prevailing standards
- Available as plug fingers only for overmolding

NP2X-B-CRYSTAL



NP3C



NP3TB-B

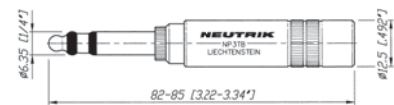

NP3CM-B



# Plugs



Bantam plug



Dual bantam plug



Gold plated contacts



Easy connector assembly

## 0.173" Bantam Type Miniature Plugs



NP3TT-1-B



NP3TT-2

- Very robust ergonomic design
- Gold contact version in combination with the NJ3TTA jack eliminates contact problems due to corrosion or dirt
- The single plug NP3TT-P and the dual bantam plug NP3TT-2 are made for assembling with a standard HEX crimping tool as used with coax cables
- Solder termination for T + R, crimp termination for sleeve contact

NP3TT-1



NP3TT-P

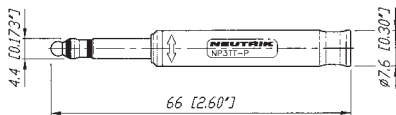

## 3.5 mm Right-Angle Stereo Plug



NTP3RC

- The only available 3.5 mm plug with chuck type strain relief
- All metal housing - reliable and robust
- Easy to assemble, simple to use
- Slim design - space saving
- Excellent cable protection
- All Nickel or black housing, available with gold plated contacts

NTP3RC

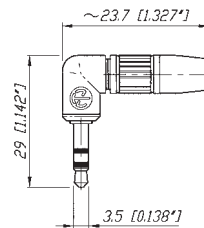

| Specifications | 1/4" Phone Plugs<br>SILENT & CRYSTAL | MIL / B-gauge Type | 0.173" Bantam Type | 3.5 mm Stereo Plugs |
|----------------|--------------------------------------|--------------------|--------------------|---------------------|
|----------------|--------------------------------------|--------------------|--------------------|---------------------|

## Electrical

|                                   |                             |   |   |   |   |
|-----------------------------------|-----------------------------|---|---|---|---|
| Rated current:                    | depends on mating connector | • | • | • | • |
| Contact resistance:               | depends on mating connector | • | • | • | • |
| Insulation resistance: - initial: | > 2 GΩ                      | • | • | • | • |
| - after damp heat test:           | ≥ 1 GΩ                      | • | • | • | • |
| Dielectric strength               | 1 kV dc                     | • | • | • | • |

## Mechanical

|                                |                  |       |                |         |         |
|--------------------------------|------------------|-------|----------------|---------|---------|
| Lifetime > 1'000 mating cycles |                  | •     | •              | •       | •       |
| Wiring:                        | solder terminals | •     | •              | •       | •       |
| Wire size                      | mm <sup>2</sup>  | 1     | 1 (NP3CM: 0.5) | 0.25    | 0.22    |
|                                | AWG              | 18    | 18 (NP3CM: 20) | 24      | 24      |
| Cable O.D.:                    | mm               | 4 - 7 | 4 - 7          | 4.8 max | 2 - 4.5 |

## Materials

|  |   |   |  |  |
|--|---|---|--|--|
| Shell:   | Zinc diecast<br>(ZnAl4Cu1) Ni or<br>black Cr plated | Brass<br>(CuZn39Pb3)<br>black or red coated | Brass (CuZn39Pb3)<br>2 μm Ni (Su) plated<br>PA 6 30 % GR | Zinc diecast<br>(ZnAl4Cu1) Ni or<br>black Cr plated<br>PA 6.6 15% GR |
| Insulation: Polyamide (PA 6.6 30 % GR)                   | •   | •   | •  | •  |
| Contacts: Brass (CuZn39Pb3)<br>2 μm Ni (Su) or Au plated | •   | • or Brass                                  | • (Tip: CuSn6)<br>2 μm TRIBOR® (NiP-AuCo)                | •  |
| Chuck:   | POM   | POM   | -  | POM  |
| Bushing:   | POM + PU  | -   | -  | CuZn39Pb3 + PU<br>(Ni or black Chrome)                               |
| Rubber shell-overlay:                                    | EPDM  | -   | -  | -  |

## Environmental

|  |   |   |   |   |
|--|---|---|---|---|
| Temperature range: -20 °C to +65 °C      | • | • | • | • |
| Solderability: Complies with IEC 68-2-20 | • | • | • | • |

## Accessories



BSP-\*



BPX-\*



PXR-\*



BSTT-\*



BSTP-\*



PCR-\*

|        |   |        |  |
|--------|---|--------|--|
| BSP-*  | Coloured bushing for NP*C Series                      | BSTP-* | Coloured sleeves for NP3TT-P Series    |
| BPX-*  | Coloured bushing for NP*X Series                      | PXR-*  | Coloured marking rings for NP*X Series |
| BPX-L  | Large bushing for NP*X Series up to 8.0 mm cable O.D. | PCR-*  | Coloured marking rings for NP*C Series |
| BSTT-* | Coloured sleeves for NP3TT Series                     |        |  |

\*: 0 - Black, 1 - Brown, 2 - Red, 3 - Orange, 4 - Yellow, 5 - Green, 6 - Blue, 7 - Violet, 8 - Grey, 9 - White; Must be ordered in multiples of 100.

## Assembly tool

|              |  |
|--------------|--|
| HX-TT-1      | Assembly and crimp tool for NP3TT-1/AU     |
| HX-R-BNC     | HEX crimp tool for NP3TT-P*                |
| DIE-R-BNC-PJ | HEX crimp die for NP3TT-P* (5.4 mm)        |
| HTXP         | Hand tool to tighten the PX and XX-bushing |
| HT-PXS       | Hand tool to hold shell of PX Plug         |

# Ordering Information

| Part Number | Shell | Contacts | Standards<br>Compatibility | Remarks |
|-------------|-------|----------|----------------------------|---------|
|-------------|-------|----------|----------------------------|---------|

## 1/4" Professional Phone Plugs - PX and PRX Series

|          |           |          |        |                           |  |
|----------|-----------|----------|--------|---------------------------|--|
| NP2X     | NP2RX     | Nickel   | Nickel | IEC 60603-11 / EIA RS-453 | Mono plug, black bushing, chuck type strain relief   |
| NP2X-BAG | NP2RX-BAG | Black Cr | Nickel | ●                         | Mono plug, black bushing, chuck type strain relief   |
| NP2X-B   | NP2RX-B   | Black Cr | Gold   | ●                         | Mono plug, black bushing, chuck type strain relief   |
| NP3X     | NP3RX     | Nickel   | Nickel | ●                         | Stereo plug, black bushing, chuck type strain relief |
| NP3X-BAG | NP3RX-BAG | Black Cr | Nickel | ●                         | Stereo plug, black bushing, chuck type strain relief |
| NP3X-B   | NP3RX-B   | Black Cr | Gold   | ●                         | Stereo plug, black bushing, chuck type strain relief |
| *-D      |           |          |        |                           | Bulk packed to be ordered in multiples of 100        |

## SILENT Guitar Plug

|                 |                |      |                         |  |
|-----------------|----------------|------|-------------------------|--|
| NP2X-AU-SILENT  | Rubber overlay | Gold | IEC 60603-11/EIA RS-453 | Mono plug , chuck-type strain relief, silent switch            |
| NP2RX-AU-SILENT | red coated     | Gold | IEC 60603-11/EIA RS-453 | right angle mono plug, chuck-type strain relief, silent switch |

## Crystal Plug

|                |          |      |                         |  |
|----------------|----------|------|-------------------------|--|
| NP2X-B-CRYSTAL | Black Cr | Gold | IEC 60603-11/EIA RS-453 | Mono plug, black bushing, chuck type strain relief, equipped with CRYSTALLIZED™ – Swarovski Elements |
|----------------|----------|------|-------------------------|--|

## 1/4" Professional Phone Plugs - PC Series

|               |                        |                  |                         |  |
|---------------|------------------------|------------------|-------------------------|--|
| NP2C          | Nickel                 | Nickel           | IEC 60603-11/EIA RS-453 | Mono plug, black bushing, chuck type strain relief   |
| NP2C-BAG      | Black Cr               | Nickel           | ●                       | Mono plug, black bushing, chuck type strain relief   |
| NP2C/B        | Black Cr               | Gold             | ●                       | Mono plug, black bushing and gold contacts, chuck type strain relief   |
| NP3C          | Nickel                 | Nickel           | ●                       | Stereo plug, black bushing, chuck type strain relief   |
| NP3C-BAG      | Black Cr               | Nickel           | ●                       | Stereo plug, black bushing, chuck type strain relief   |
| NP3C/B        | Black Cr               | Gold             | ●                       | Stereo plug, black bushing and gold contacts, chuck type strain relief   |
| NP2C-BAG-T-AU | Black Cr               | Nickel + T: Gold | ●                       | Mono plug, black bushing with gold tip, chuck type strain relief   |
| NP2C-T10AA    | Nickel                 | Nickel           | ●                       | Mono plug, red bushing, with built-in 1:10 transformer to convert microphone levels to guitar inputs, chuck type strain relief |
| NP2RCS        | Nickel + black plastic | Nickel           | ●                       | Mono right-angle plug, black bushing, chuck type strain relief   |
| NP3RCS        | Nickel + black plastic | Nickel           | ●                       | Stereo right-angle plug, black bushing, chuck type strain relief   |
| NP*C-D        |                        |                  |                         | Bulk packed to be ordered in multiples of 100  |

## MIL/B-gauge Type Phone Plugs

|         |       |        |                |  |
|---------|-------|--------|----------------|--|
| NP3TB-B | Black | Nickel | B-GAUGE BP0316 | 1/4" B-Gauge plug, chuck type strain relief                |
| NP3TB-R | Red   | Nickel | ●              | 1/4" B-Gauge plug, chuck type strain relief                |
| NP3TM-B | Black | Nickel | MIL-P-642/2    | 1/4" MIL plug , chuck type strain relief                   |
| NP3TM-R | Red   | Nickel | ●              | 1/4" MIL plug , chuck type strain relief                   |
| NP2CM-B | Black | Brass  | MIL-P-642/4    | Mono 1/4" MIL plug, chuck type strain relief               |
| NP2CM-R | Red   | Brass  | ●              | Mono 1/4" MIL plug, chuck type strain relief               |
| NP3CM-B | Black | Brass  | MIL-P642/5A    | Stereo 5.23 mm (0.206") MIL plug, chuck type strain relief |
| NP3CM-R | Red   | Brass  | ●              | Stereo 5.23 mm (0.206") MIL plug, chuck type strain relief |

## 0.173" Bantam Type Miniature Plugs

|              |                        |        |              |   |
|--------------|------------------------|--------|--------------|---|
| NP3TT-1-B    | Nickel + black plastic | Nickel | MIL-P-642/13 | 4.4 mm (0.173") Bantam plug with solder contacts, black sleeve      |
| NP3TT-1-R    | Nickel + red plastic   | Nickel | ●            | 4.4 mm (0.173") Bantam plug with solder contacts, red sleeve        |
| NP3TT-AU-B   | Nickel + black plastic | Gold   | ●            | 4.4 mm (0.173") Bantam plug with solder contacts, black sleeve      |
| NP3TT-AU-R   | Nickel + red plastic   | Gold   | ●            | 4.4 mm (0.173") Bantam plug with solder contacts, red sleeve        |
| NP3TT-P-B    | Black plastic          | Nickel | ●            | 4.4 mm (0.173") Bantam plug with solder contacts, black sleeve      |
| NP3TT-P-R    | Red plastic            | Nickel | ●            | 4.4 mm (0.173") Bantam plug with solder contacts, red sleeve        |
| NP3TT-P-AU-B | Black plastic          | Gold   | ●            | 4.4 mm (0.173") Bantam plug with solder contacts, black sleeve      |
| NP3TT-P-AU-R | Red plastic            | Gold   | ●            | 4.4 mm (0.173") Bantam plug with solder contacts, red sleeve        |
| NP3TT-2      | Black plastic          | Nickel | ●            | 4.4 mm (0.173") Twin Bantam plug with solder contacts, black sleeve |

## 3.5 mm Right-Angle Stereo Plug

|          |          |        |              |  |
|----------|----------|--------|--------------|--|
| NTP3RC   | Nickel   | Nickel | IEC 60603-11 | 3.5 mm audio plug with chuck and bushing |
| NTP3RC-B | Black Cr | Gold   | IEC 60603-11 | 3.5 mm audio plug with chuck and bushing |



# Locking Jacks



1/4" cable jack with locking



Release latch

## Locking 1/4" Cable Jacks



NJ3FC6



NJ3FC6-BAG

- Securely locking cable jack
- Mates with all mono or stereo plugs specified to EIA RS-453
- Extremely robust and reliable
- Excellent Neutrik cable retention
- Coloured boots available in 10 colours
- For cable O.D. up to 8 mm

## Locking 1/4" Chassis Jacks



NJ3FP6C



NJ3FP6C-BAG

- Mates with all mono or stereo plugs specified to EIA RS-453
- Dimensionally compatible with D Series (31 x 26 mm)
- Securely locking chassis jack
- Solder terminals
- Special version with black plastic shell
- Choice of grounding option

### NJ3FC6



### NJ3FP6C





Snapping cap



Solder tags

## 1/4" Vertical Jacks



NJ\*FD-V



NJ6TB-V



- Quick Cap Fixing System reduces assembly time drastically through snapping mounting cap
- Retention force is provided by a special spring element, independent from contacts
- All common circuits available
- Two versions for mating of plugs acc. to EIA RS-453 (NJ\*FD-V) or B-gauge BP0316 (NJ\*TB-V)

### NJ\*FD-V

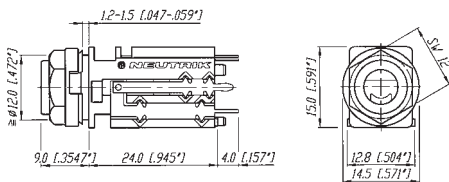

\* ... 2, 3, 5, 6





Half threaded nose



Chrome ferrule



Plastic nut

## M Jacks



NMJ4HHD2



NMJ2HC-S



NMJ6HFD2

- Wide body and extremely durable contacts
- Available in all common versions:
  - mono
  - stereo
  - switched
  - unswitched
- Hardwire and PCB version
- Nose type in
  - half threaded
  - fully threaded
  - chrome ferrule
- Full threaded and chrome nose M Jacks are supplied with washer and fixing nut
- Mounting hardware for half threaded nose must be ordered separately
- Fascia appearance in plastic or chrome

### NMJ6HHD2



### NMJ4HC-S

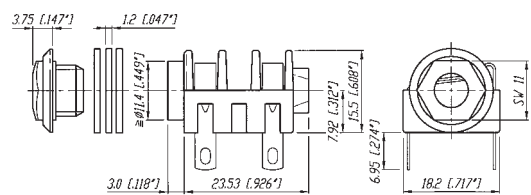

### NMJ6HFD2

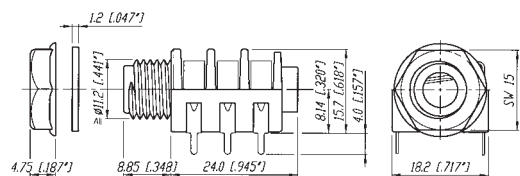

### NRJ-NUT-B



### NRJ-WB (washer)



# Horizontal PCB Jacks



Half threaded nose



Chrome nose



Chassis ground contact



Gold plated contact

## Slim Jacks



NRJ4HH-1



NRJ6HF-1



NRJ6HM-1-AU



NRJ-NUT-B



NRJ-NUT-MK



NRJ-NUT-MS



NRJ-NUT-MN  
(Metal Nose only)

- High board packing densities
- Nose type in
  - half thread
  - fully threaded
  - metal
- Meeting the requirements of EMC rules through efficient chassis grounding system
- Retention spring ensures optimum grip on inserted plugs, avoiding the chance of lost connection
- All Slim line jacks have PCB horizontal mount pins
- Mounting nuts in different versions available - must be ordered separately

NRJ-NUT-B



NRJ-NUT-MK

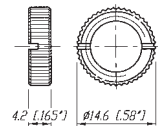

NRJ-NUT-MS

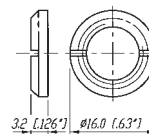

NRJ-NUT-MN  
(Metal Nose only)

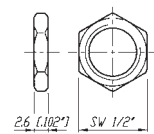

NRJ4HH-1



NRJ4HF-1



NRJ6HM-1

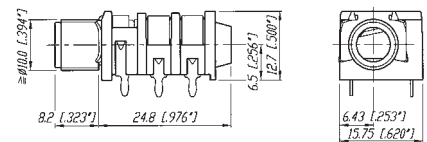

# PCB Mount Stacking Jacks



Plane nose



Quick fix nose

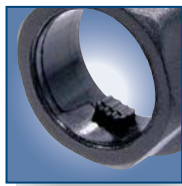

Quick fix nut



Fully threaded nose

## Stacking Jacks



NSJ8HC



NSJ12HL



NSJ12HH-1



NSJ12HF-1

- Mono and stereo dual slim jack socket for PCB mounting with switch contacts
- Mounting method by either two quick fix or threaded nuts or one single center screw
- Highest board packing density as two jacks are in a single footprint, fit in 1 RU
- Version in fully and half threaded nose, full nose and quick-fit

NSJ8HC

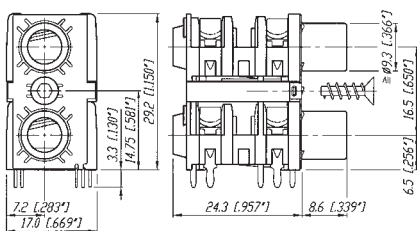

NSJ12HL

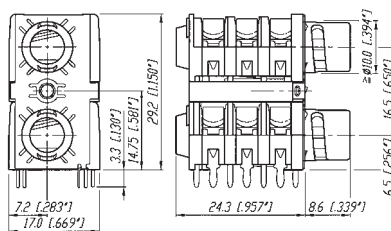

NSJ-NUT-B  
(Quick fix nut)

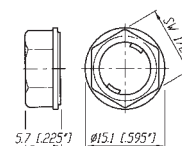

NSJ12HH-1

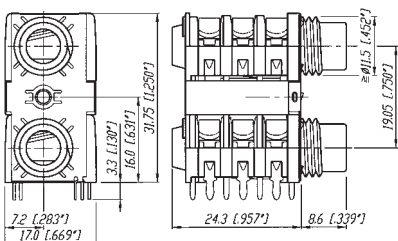

NSJ12HF-1

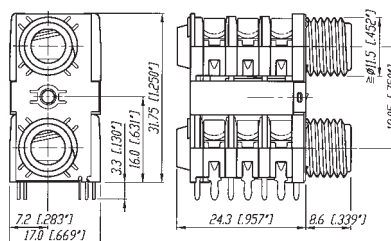

NRJ-NUT-B

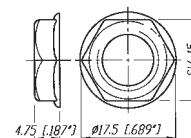

## Specifications

|  | Vertical Jack | Locking Cable & Chassis Jack | M Jack | Slim Jack | Stacking Jack |
|--|---------------|------------------------------|--------|-----------|---------------|
|--|---------------|------------------------------|--------|-----------|---------------|

## Electrical

|                               |                  |               |        |              |              |              |
|-------------------------------|------------------|---------------|--------|--------------|--------------|--------------|
| Contact resistance            | - initial:       | < 10 mΩ       | < 6 mΩ | < 15 mΩ      | < 10 mΩ      | -            |
|                               | - Top row:       | -             | -      | -            | -            | < 15 mΩ      |
|                               | - Bottom row:    | -             | -      | -            | -            | < 10 mΩ      |
| Switch contact resistance:    | - for silver:    | -             | -      | < 30 mΩ      | < 25 mΩ      | -            |
|                               | - for gold:      | < 15 mΩ       | -      | -            | < 10 mΩ      | -            |
|                               | - Top row:       | -             | -      | -            | -            | < 15 mΩ      |
|                               | - Bottom row:    | -             | -      | -            | -            | < 10 mΩ      |
| Insulation resistance:        | ≥ 1GΩ @ 500 V dc | ●             | ●      | ●            | ●            | ●            |
| Dielectric strength           | 1 kV dc          | ●             | ●      | ●            | ●            | ●            |
| Rated current:                |                  | 3 A           | 10 A   | 3 A          | 3 A          | 3 A          |
| Rated switch contact current: |                  | 0.25 A @ 12 V | N/A    | 0.5 A @ 50 V | 0.5 A @ 50 V | 0.5 A @ 50 V |

## Mechanical

|  |                              |   |                 |                 |                 |                 |
|--|------------------------------|---|-----------------|-----------------|-----------------|-----------------|
| Lifetime                                 | > 10'000 cycles              | ●                                       | ●               | ●               | ●               | ●               |
| Insertion / withdrawal force:            | < 10 N / > 8 N               | < 20 N / > 20N                          | < 20 N / > 10 N | < 20 N / > 10 N | < 20 N / > 10 N | < 20 N / > 10 N |
| Cap opening torque:                      | 25 N cm / 9.84 N in          | -                                       | -               | -               | -               | -               |
| Locking force:                           |                              | > 80 N                                  | -               | -               | -               | -               |
| Wire size:                               |                              | 1 mm <sup>2</sup> / 18 AWG <sup>Ⓞ</sup> | -               | -               | -               | -               |
| Cable O.D. (FC6 only)                    |                              | 3.5 - 8.0 mm                            | -               | -               | -               | -               |
| Solderability complies with IEC 68-2-20: |                              | ●                                       | ●               | ●               | ●               | ●               |
| Standard Compatibility:                  |                              |   |                 |                 |                 |                 |
| EIA RS 453 + IEC 60603-11                | NJ*FD                        | ●                                       | ●               | ●               | ●               | ●               |
| B-GAUGE BPO 316, MIL-J-641/3             | NJ*TB                        | -                                       | -               | -               | -               | -               |
| Panel thickness:                         | 1.2 - 1.5 mm [0.047 - 0.06"] | -                                       | -               | -               | -               | -               |
|  | - Full nose type:            | -                                       | -               | < 3.0 mm        | < 3.0 mm        | -               |
|  | - Half nose type:            | -                                       | -               | < 1.0 mm        | < 1.0 mm        | -               |
|  | - Chrome nose:               | -                                       | -               | < 4.7 mm        | -               | -               |
|  | - NSJ*HL:                    | -                                       | -               | -               | -               | 1.0 - 1.6 mm    |
|  | - NSJ*HC:                    | -                                       | -               | -               | -               | > 1.0 mm        |

## Material

|                             |                |  |               |                         |                   |
|-----------------------------|----------------|--|---------------|-------------------------|-------------------|
| Shell / Handle:             | PA 6.6 30% GR  | ZnAl4Cu1<br>Ni plated or<br>black coated | PA 6.6 15% GR | PA 6 15% GR             | PA 6 15% GR       |
|                             | - FP6P:        | PA 6.6 30% GR                            | -             | -                       | -                 |
| Insulation:                 |                | PA 6.6 30% GR                            | -             | -                       | -                 |
| Contacts:                   | CuSn6          | CuBe2/CuZn37 (ground)                    | Ni-Silver     | CuSn6                   | CuSn6             |
| Contact surface:            | 0.2 μm Au      | 2 μm Ag                                  | -             | gal 2 μm Ag / 0.2 μm Au | gal 2 μm Ag       |
| Cap / Nut / Washer:         | POM            | -  | PA 6.6 15% GR | PA 6.6 15% GR           | PA 6.6 15% GR     |
| Ring Nut:                   | -              | -  | -             | Brass (Ni plated)       | Brass (Ni plated) |
| Chuck:                      | -              | POM                                      | -             | -                       | -                 |
| Bushing:                    | -              | PA 6.6 15% GR + PUR                      | -             | -                       | -                 |
| Temperature range:          | -25°C to +70°C | ●  | ●             | ●                       | ●                 |
| Ⓞ... max. for soldering tag |                |  |               |                         |                   |

## Circuits:



| Part Number | Shell | Contacts | Terminations | Standards Compatibility | Remarks |
|-------------|-------|----------|--------------|-------------------------|---------|
|-------------|-------|----------|--------------|-------------------------|---------|

## Slim Jack

### PCB Mount Sockets - Switched

|             |                 |        |                          |                         |  |
|-------------|-----------------|--------|--------------------------|-------------------------|--|
| NRJ3HF-1    | Black/Plastic   | Silver | Horizontal PCB soldering | IEC 60603-11/EIA RS 453 | Mono, full threaded nose, chassis ground contact                         |
| NRJ4HF      | ●               | ●      | ●                        | ●                       | Mono, full threaded nose   |
| NRJ4HF-1    | ●               | ●      | ●                        | ●                       | Mono, full threaded nose, chassis ground contact                         |
| NRJ6HF      | ●               | ●      | ●                        | ●                       | Stereo, full threaded nose   |
| NRJ6HF-1    | ●               | ●      | ●                        | ●                       | Stereo, full threaded nose, chassis ground contact                       |
| NRJ4HH      | ●               | ●      | ●                        | ●                       | Mono, half threaded nose   |
| NRJ4HH-1    | ●               | ●      | ●                        | ●                       | Mono, half threaded nose, chassis ground contact                         |
| NRJ6HH      | ●               | ●      | ●                        | ●                       | Stereo, half threaded nose   |
| NRJ6HH-1    | ●               | ●      | ●                        | ●                       | Stereo, half threaded nose, chassis ground contact                       |
| NRJ6HF-AU   | ●               | Gold   | ●                        | ●                       | Stereo, full threaded nose, gold plated contacts                         |
| NRJ6HF-1-AU | ●               | Gold   | ●                        | ●                       | Stereo, full threaded nose, chassis ground contact, gold plated contacts |
| NRJ6HH-AU   | ●               | Gold   | ●                        | ●                       | Stereo, half threaded nose, gold plated contacts                         |
| NRJ-NUT-B   | ●               | -      | -                        | -                       | Hexagonal black plastic nut  |
| NRJ-NUT-R   | Red/Plastic     | -      | -                        | -                       | Hexagonal red plastic nut  |
| NRJ-NUT-MK  | Metal/Ni plated | -      | -                        | -                       | Metal ring nut, knurled  |
| NRJ-NUT-MS  | Metal/Ni plated | -      | -                        | -                       | Metal ring nut   |

### PCB Mount Sockets - Switched with Metal Nose

|             |               |        |                          |                         |   |
|-------------|---------------|--------|--------------------------|-------------------------|---|
| NRJ4HM-1    | Black/Plastic | Silver | Horizontal PCB soldering | IEC 60603-11/EIA RS 453 | Mono, metal threaded nose                         |
| NRJ4HM-1-AU | ●             | Gold   | ●                        | ●                       | Mono, metal threaded nose, gold plated contacts   |
| NRJ6HM-1    | ●             | Silver | ●                        | ●                       | Stereo, metal threaded nose                       |
| NRJ6HM-1-AU | ●             | Gold   | ●                        | ●                       | Stereo, metal threaded nose, gold plated contacts |
| NRJ-NUT-MN  | Metal         | -      | -                        | -                       | Hexagonal metal nut (for metal nose jack only)    |

## Stacking Jack

|           |                    |        |                          |                         |                        |
|-----------|--------------------|--------|--------------------------|-------------------------|------------------------|
| NSJ8HL    | Polyamid PA 6.6 GR | Silver | Horizontal PCB soldering | IEC 60603-11/EIA RS 453 | Mono, quick fix nose   |
| NSJ12HL   | ●                  | ●      | ●                        | ●                       | Stereo, quick fix nose |
| NSJ8HC    | ●                  | ●      | ●                        | ●                       | Mono, full nose        |
| NSJ12HC   | ●                  | ●      | ●                        | ●                       | Stereo, full nose      |
| NSJ12HF-1 | ●                  | ●      | ●                        | ●                       | Full threaded nose     |
| NSJ12HH-1 | ●                  | ●      | ●                        | ●                       | Half threaded nose     |
| NSJ-NUT-B | Black/Plastic      | -      | -                        | -                       | Quick fix nut          |

All Slim jacks are for PCB mount only.

Mounting nuts must be ordered separately, except for Stacking Jack type NSJ8HL and NSJ12HL.

### Ordering Key:

|              |                         |           |                      |
|--------------|-------------------------|-----------|----------------------|
| <b>NRJ*H</b> | NEUTRIK Jack Horizontal | *         | number of contacts:  |
| <b>H</b>     | half threaded nose      | <b>2</b>  | mono unswitched      |
| <b>F</b>     | full threaded nose      | <b>4</b>  | mono switched        |
| <b>L</b>     | quick fix nose          | <b>6</b>  | stereo switched      |
| <b>M</b>     | metal threaded nose     | <b>8</b>  | mono stacking jack   |
| <b>C</b>     | plane nose              | <b>12</b> | stereo stacking jack |
| <b>-1</b>    | chassis ground contact  |           |                      |

**Nose:**

**-H**



**-F**



**-M**



**-L**



**-C**

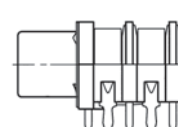

# Ordering Information

| Part Number | Shell | Contacts | Terminations | Standards Compatibility | Remarks |
|-------------|-------|----------|--------------|-------------------------|---------|
|-------------|-------|----------|--------------|-------------------------|---------|

## 1/4" Locking Jack

|             |               |        |                |                         |                 |
|-------------|---------------|--------|----------------|-------------------------|-----------------|
| NJ3FC6      | Nickel        | Silver | Wire soldering | IEC 60603-11/EIA RS 453 | Cable Jack      |
| NJ3FC6-BAG  | Black         | ●      | ●              | ●                       | ●               |
| NJ3FP6C     | Nickel        | ●      | ●              | ●                       | Chassis Jack    |
| NJ3FP6C-B   | Black         | Gold   | ●              | ●                       | ●               |
| NJ3FP6C-BAG | Black         | Silver | ●              | ●                       | ●               |
| NJ3FP6F-P   | Nickel        | ●      | ●              | ●                       | ●               |
| NJ3FP6P-BAG | Black/Plastic | ●      | ●              | ●                       | Plastic Chassis |

## Accessories

|       |   |   |      |  |   |
|-------|---|---|------|--|---|
| DSS-* | Lettering plate, coloured plastic                       |  | NDJ  | Dummy-plug for 1/4" chassis jack                 |          |
| SCDR  | Rear end protection cover for locking 1/4" chassis jack |  | SCDX | Hinged cover seals 1/4" chassis jack, IP42 rated |  Example |

## 1/4" Vertical Jack

|         |               |      |                        |                            |   |
|---------|---------------|------|------------------------|----------------------------|---|
| NJ2FD-V | Black/Plastic | Gold | Vertical PCB soldering | IEC 60603-11/EIA RS 453    | Non-switching Mono Jack (T/S)                           |
| NJ3FD-V | ●             | ●    | ●                      | ●                          | Non-switching Stereo Jack (T/R/S)                       |
| NJ5FD-V | ●             | ●    | ●                      | ●                          | 2 x switching (normalling) Stereo jack (T/TN/R/RN/S)    |
| NJ6FD-V | ●             | ●    | ●                      | ●                          | 3 x switching (normalling) Stereo jack (T/TN/R/RN/S/SN) |
| NJ6TB-V | ●             | ●    | ●                      | B-Gauge BPO316 Mil-J-641/3 | 3 x switching (normalling) Stereo jack (T/TN/R/RN/S/SN) |

## M Jack

|          |               |        |                          |                         |   |
|----------|---------------|--------|--------------------------|-------------------------|---|
| NMJ2HF-S | Black/Plastic | Silver | Horizontal PCB soldering | IEC 60603-11/EIA RS 453 | Mono, unswitched, full threaded nose, solder tags                       |
| NMJ3HF-S | ●             | ●      | ●                        | ●                       | Stereo, unswitched, full threaded nose, solder tags                     |
| NMJ4HF-S | ●             | ●      | ●                        | ●                       | Mono, switched, full threaded nose, solder tags                         |
| NMJ2HC-S | ●             | ●      | ●                        | ●                       | Mono, unswitched, Chrome ferrule, solder tags                           |
| NMJ4HC-S | ●             | ●      | ●                        | ●                       | Mono, switched, Chrome ferrule, solder tags                             |
| NMJ4HFD2 | ●             | ●      | ●                        | ●                       | Mono, switched, full threaded nose, PCB mount                           |
| NMJ4HFD3 | ●             | ●      | ●                        | ●                       | Mono, switched, full threaded nose, offset PCB mount                    |
| NMJ4HCD2 | ●             | ●      | ●                        | ●                       | Mono, switched, Chrome ferrule, PCB mount,                              |
| NMJ4HHD2 | ●             | ●      | ●                        | ●                       | Mono, switched, half threaded nose, PCB mount, without nut and washer   |
| NMJ6HF-S | ●             | ●      | ●                        | ●                       | Stereo, switched, full threaded nose, solder tags                       |
| NMJ6HC-S | ●             | ●      | ●                        | ●                       | Stereo, switched, Chrome ferrule, solder tags                           |
| NMJ6HCD2 | ●             | ●      | ●                        | ●                       | Stereo, switched, Chrome ferrule, PCB mount                             |
| NMJ6HHD2 | ●             | ●      | ●                        | ●                       | Stereo, switched, half threaded nose, PCB mount, without nut and washer |
| NMJ6HFD2 | ●             | ●      | ●                        | ●                       | Stereo, switched, full threaded nose, PCB mount                         |
| NMJ6HFD3 | ●             | ●      | ●                        | ●                       | Stereo, switched, full threaded nose, offset PCB mount                  |
| NMJ6HCD3 | ●             | ●      | ●                        | ●                       | Stereo, switched, Chrome ferrule, offset PCB mount                      |
| NMJ6HFD4 | ●             | ●      | ●                        | ●                       | Stereo, switched, full threaded nose, tear drop PCB mount               |

Full threaded and Chrome nose M-Jacks are supplied with fixing nut and washers. Mounting hardware for half threaded nose must be ordered separately.

## Ordering Key:

|              |                           |                                  |
|--------------|---------------------------|----------------------------------|
| <b>NMJ*H</b> | NEUTRIK M Jack Horizontal | * number of contacts:            |
| <b>H</b>     | half threaded nose        | <b>2</b> mono unswitched         |
| <b>F</b>     | fully threaded nose       | <b>3</b> stereo unswitched       |
| <b>C</b>     | chrome nose               | <b>4</b> mono switched           |
| <b>-S</b>    | solder tag                | <b>5</b> stereo switched (T/S)   |
| <b>D2</b>    | PCB pins 02               | <b>6</b> stereo switched (T/R/S) |
| <b>D3</b>    | PCB pins 03               |                                  |
| <b>D4</b>    | PCB pins 04               |                                  |





Gold plated contacts



Soft-touch surface



Phono socket

## Profi® RCA Series

**NEW**



NF2C

- Makes ground before signal contact and breaks signal before ground
- No more disturbing noise and broken speaker cones
- Precisely machined to our demanding quality standards
- Neutrik unique chuck type strain relief
- Gold plated contacts
- Sleek barrel with soft touch surface and coloured shrink sleeve
- Improved ground solder lug for ease soldering

NF2C



## Phono Socket



NF2D-4



NF2D-B-6

- Makes ground before signal contact and breaks signal before ground
- No more disturbing noise and broken speaker cones
- Precisely machined to our demanding quality standards
- Gold plated contacts

NF2D-\*



\* available in 9 colours see page 48

| Specification | Profi® | Phono Socket |
|---------------|--------|--------------|
|---------------|--------|--------------|

## Electrical

|                             |                     |           |          |
|-----------------------------|---------------------|-----------|----------|
| Rated current per contact:  | 16 A rms continuous | ●         | ●        |
| Rated insulation voltage:   | 50 V ac             | ●         | ●        |
| Contact resistance:         |                     | > 100 GΩ  | < 5 GΩ   |
| Dielectric strength:        |                     | 1500 V dc | 500 V dc |
| Capacitance (pin to shell): |                     | 7 pf      | 9 pf     |

## Mechanical

|                            |                                   |   |   |
|----------------------------|-----------------------------------|---|---|
| Life time (mating cycles): | > 5000                            | ● | ● |
| Cable O.D. range:          | 3.0 - 7.3 mm                      | ● | - |
| Wiring:                    | soldering                         | ● | ● |
| Max. wire size :           | 2.5 mm <sup>2</sup> / 14 AWG      | ● | - |
| Cable anchoring:           | Neutrik® chuck type strain relief | ● | - |
| Solderability:             | complies with IEC 68-2-20         | ● | ● |

## Material

|                  |                             |   |   |
|------------------|-----------------------------|---|---|
| Housing:         | Brass (CuZn39Pb3)           | ● | - |
|                  | Zinc diecast (ZnAlCu1)      | - | ● |
| Insert:          | PBTP 20% GR                 | ● | - |
| Contacts:        | Brass (CuZn39Pb3)           | ● | ● |
| Contact plating: | 5 μm Au plated over 5 μm Ni | ● | ● |
| Chuck:           | Polyacetal (POM)            | ● | - |

## Environment

|                    |                |   |   |
|--------------------|----------------|---|---|
| Temperature range: | -30°C to +80°C | ● | ● |
| Protection class:  | IP 40          | ● | ● |
| Flammability:      | UL 94 HB       | ● | ● |

## Ordering Information

### Phono Profi®

|         |  |
|---------|--|
| NF2C-B2 | Professional "phono Plug" (RCA or CINCH type), two plugs with red and black coding, two strain relief chucks for a second cable diameter |
|---------|--|

### Phono (RCA) Socket

|   |   |
|---|---|
| NF2D-*  | Chassis Phono (RCA) socket in D Shape housing       |
| NF2D-B-*  | Chassis Phono (RCA) socket in black D Shape housing |
| * color coding: 0 - Black, 1 - Brown, 2 - Red, 3 - Orange, 4 - Yellow, 5 - Green, 6 - Blue, 7 - Violet, 8 - Grey, 9 - White |   |

## Accessories

|      |  |
|------|--|
| NDP  | Dummy plug for phone socket  |
| SCL  | Plastic sealing cover to protect the connector sockets against dust and moisture |
| SCDX | Hinged cover seals D-size chassis connectors, IP54 rated                         |





# Loudspeaker Connectors

## Content

## Page

|  |    |  |    |
|--|----|--|----|
| Speakon® SPX Series 4 Pole Cable Connector .....         | 51 | Speakon® STX Series Cable Connector .....  | 58 |
| Speakon® FC Series, 2, 4 and 8 Pole Cable Connector .... | 53 | Speakon® STX Series Chassis Connector..... | 59 |
| Speakon® Adapter .....                                   | 54 | Technical Data .....                       | 61 |
| Speakon® Chassis Connector .....                         | 55 | Wiring .....                               | 62 |
| Speakon® Combo .....                                     | 57 |  |    |

## Introduction

The Neutrik® Speakon® Series, in the Pro Audio industry often called "The loudspeaker connector", became the state of the art for speaker and amplifier connections.

Invented by Neutrik® as a result of various customer requests, the first Speakon® had been introduced in 1987. The pro audio market realized very quickly the advantages of this completely new connection system. The design has been optimized for loudspeaker applications with an outstanding cost-performance ratio.

As market leader for speaker connections we are proud to offer an all-embracing product line for the specific needs of this market today. Latest designs as the STX series or the Speakon® Combo also meet the demands of niche applications or extremely rough conditions and complete the product range.

## Integrated Design

Neutrik's aim to be distinctively recognizable is realized by the technological head start on the one hand as well as both patent and trademark protection on the other hand.



To draw a clear line between Neutrik® and competition products we give our customer the possibility to easily identify the original.

Therefore all of our new products as the SPX and the STX series are designed according the protected integrated design. (EU-Pat.: DM/057 379, US-Pat. Pending, CHINA-Pat.: 0230519 2.2/193.0/194.9/195.7)



## Features & Benefits

Today's Speakon® series is a result of a continuous product improvement process. The principal idea has been kept and optimized with material and design modifications over the years.

A traditional Speakon® stands for:

- Reliable and robust, easy and fast to assemble
- 2, 4 and 8-pole cable and chassis connectors in various versions
- Optimal "Quick Lock" system for speaker applications
- Neutrik® proven and unique chuck type cable strain relief
- Outstanding cost-performance ratio
- Defacto standard
- Meets all Worldwide Safety requirements (IEC, UL, ...)

Beyond that, the latest designs as the SPX and STX series offer:

- Up to 50 Amps current rating
- Only 3 parts with 1 piece strain relief design for even easier assembly
- Convertable right-angle version
- Weatherproof and extremely robust all metal design
- Complete system, 4 pole female chassis and male cable connector



Quick lock



Chuck type strain relief



Right angle conversion



## Speakon® SPX Series 4 Pole Cable Connector



NL4FX



NL4FRX

### Features

- Up to 50 A current rating
- Only 3 parts, easy to assemble
- High Impact Materials

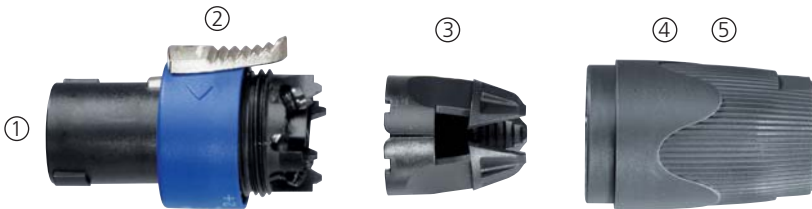

- ① Easy and extremely precise locking system "Quick Lock"
- ② Improved grip on latch
- ③ 1 piece strain relief, chuck for 6 to 14.5 mm cable O.D.
- ④ Color coding possible
- ⑤ Integrated design guaranties "Made by Neutrik®"

### Improved SPX-Series screw contacts! (Wire position after assembly.)



- ① Progressive clamping as wire is pushed forward
- ② Acts as screw locking device due to side forces
- ③ Large combi drive - M4 screw
- ④ Wire size 1.5 - 4 mm<sup>2</sup> (AWG 12) for 6 mm<sup>2</sup> (AWG 10) remove screw & solder
- ⑤ Pull out force > 300 N @ 80 cNm
- ⑥ Gas tight connection

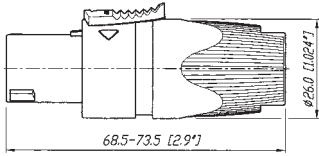

NL4FX

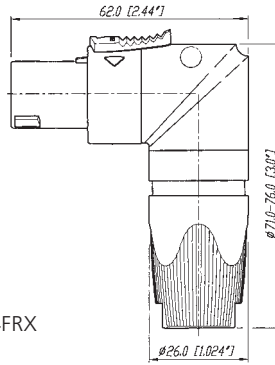

NL4FRX

## Design Criteria

This second generation of Speakon® connectors features higher current rating for the operation of high power speakers and amplifiers carrying more than 1000 Watts. Only 3 parts make it fast and easy to assemble with a more reliable

performance. Our unique design makes it possible to change easily and quickly from a straight connector to the right-angle version, even without disconnecting the cable.

## Assembly

Prepare cable as shown.



### HINT:

For easy wiring especially of thick cables, first screw on the inner contacts 1+ and 2+ and afterwards the outer contacts 1- and 2- !  
Use screwdriver Pozidrive #1 only.



## Ordering Information

|         |  |
|---------|--|
| NL4FX   | Cable Connector with chuck and bushing             |
| NL4FX-2 | Cable Connector with chuck and red bushing         |
| NL4FX-4 | Cable Connector with chuck and yellow bushing      |
| NL4FX-5 | Cable Connector with chuck and green bushing       |
| NL4FX-9 | Cable Connector with chuck and white bushing       |
| NL4FRX  | Right-angle Cable Connector with chuck and bushing |

## Accessories



LCR-\*



LRX

|       |  |
|-------|--|
| LCR-* | Coloured coding rings for the right-angle version of the SPX Series. Available in blue (Standard), white, red, green and yellow.               |
| LRX   | Right-angle Speakon® Conversion Kit for changing the straight connector into a right-angel version without removing the cable from the insert. |



Locking ring



Quick lock



## Speakon® FC Cable Connector Series



NL2FC

**NEW**



NL4FC



NL8FC

- 4 pole - Branded with unique hologram - guarantees genuine and authentic Neutrik product
- Up to 30 A rms current rating
- Glass reinforced materials for housing and inserts
- Unique Neutrik® chuck type strain relief
- Precise keyway for secure mating
- Accurate twist lock latching system
- 4 pole in new design with more ergonomic latch

### Keying:



NL2FC

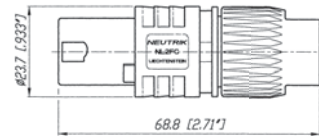

NL4FC



NL8FC



## Ordering Information

|             |   |
|-------------|---|
| NL2FC       | 2 pole Cable Connector with locking ring, integrated cable clamp, intermates with 4-pole chassis connector and makes contact with +1/-1 |
| NL4FC       | 4 pole Cable Connector with latch lock  |
| NL8FC       | 8 pole Cable Connector with latch lock  |
| Accessories |   |
| BSL-*       | Coloured bushing for NL4FC  |



1/4" Jack adapter



Extension coupler

## Speakon® Adapter



NA4LJ



NL4MMX



NL8MM

### NL4MMX

Features permanent secure connection on a Speakon® cable connector using 2<sup>nd</sup> lock.



Secure Lock!

### NL4MMX + NL4FX (locked on the cable)

Changes gender to male when permanently locked on the cable.



### NA4LJ



ø6,35 [1/4"]



78.0 [3.071"]

### NL4MMX



25.5 [1.0"]



50.0 [1.97"]

### NL8MM



38.0 [1.496"]



79.6 [3.134"]

## Ordering Information

|        |   |
|--------|---|
| NA4LJ  | Adapter from Speakon® Cable Connector to 2 pole 1/4" Jack, wiring: +1 to TIP and -1 to SLEEVE |
| NL4MMX | 4 pole lockable coupler to extend two 4-pole cables   |
| NL8MM  | 8 pole coupler to extend two 8-pole cables  |



Reinforced locking area



Nickel housing



3/16" flat tabs



Vertical PCB mount



## Speakon® Chassis Connector



NL2MP



NL4MD-H-1



NL4MD-H-3



NL4MPR



NL8MPR

- Standard version up to 30 A rms, ultra high current version up to 50 A audio current
- Glass reinforced materials
- Precise keyway for secure mating
- Accurate twist lock latching system
- Metal front plate (8-pole) or metal insert in locking area (2 & 4-pole)
- Various mounting and wiring possibilities
- "Air tight design", optimized for speaker applications
- D or G panel cutouts to be easily mounted on audio industry standard panels
- 4 pole branded with unique hologram

### NL4MD-V



### NL4MD-H



### NL4MP

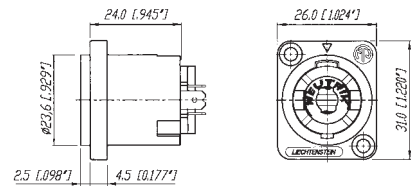

### NL4MPR

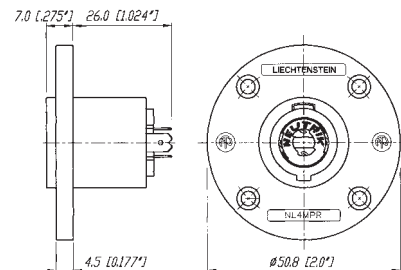

### NL8MPR

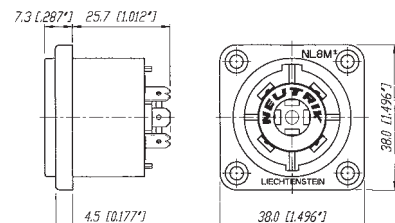

## Ordering Information

Flange layout:

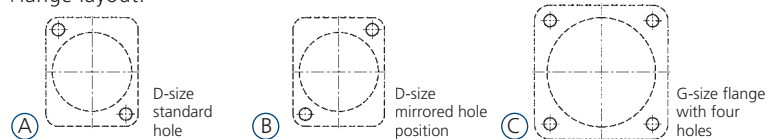

Hole layout:

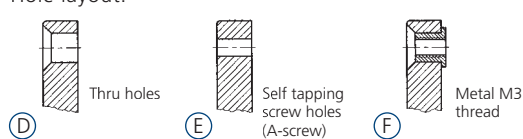

|             | Pole | Flange size          | Flange layout | Hole layout | Color        | Wiring           | Remarks  |
|-------------|------|----------------------|---------------|-------------|--------------|------------------|--|
| NL2MP       | 2    | D-size               | A             | D           | black        | 3/16" flat tabs* | Does not intermate with 4-pole cable connector |
| NL2MD-H     | 2    | D-size               | A             | D           | black        | horizontal PCB   | Does not intermate with 4-pole cable connector |
| NL2MD-V     | 2    | D-size               | A             | D           | black        | vertical PCB     | Does not intermate with 4-pole cable connector |
| NL4MP       | 4    | D-size               | A             | D           | black        | 3/16" flat tabs* |  |
| NL4MP-1     | 4    | D-size               | A             | E           | grey         | 3/16" flat tabs* |  |
| NL4MP-2     | 4    | D-size               | B             | E           | black        | 3/16" flat tabs* |  |
| NL4MP-3     | 4    | D-size               | A             | E           | black        | 3/16" flat tabs* |  |
| NL4MP-M3    | 4    | D-size               | A             | F           | black        | 3/16" flat tabs* |  |
| NL4MD-H     | 4    | D-size               | A             | E           | grey         | horizontal PCB   |  |
| NL4MD-H-1   | 4    | D-size               | A             | D           | black        | horizontal PCB   |  |
| NL4MD-H-2   | 4    | D-size               | B             | E           | black        | horizontal PCB   |  |
| NL4MD-H-3   | 4    | D-size               | A             | E           | black        | horizontal PCB   |  |
| NL4MD-V     | 4    | D-size               | A             | D           | black        | vertical PCB     |  |
| NL4MD-V-1   | 4    | D-size               | A             | E           | grey         | vertical PCB     |  |
| NL4MD-V-2   | 4    | D-size               | B             | E           | black        | vertical PCB     |  |
| NL4MP-ST    | 4    | D-size               | A             | D           | black        | screw terminal   |  |
| NL4MP-UC    | 4    | D-size               | A             | D           | black        | 1/4" flat tabs*  | Ultra high current, up to 40 A rms             |
| NL4MPR      | 4    | round G-size flange  | C             | D           | black        | 3/16" flat tabs* |  |
| NL8MD-V     | 8    | square G-size flange | C             | D           | Ni           | vertical PCB     |  |
| NL8MD-V-BAG | 8    | square G-size flange | C             | D           | black chrome | vertical PCB     |  |
| NL8MD-V-1   | 8    | square G-size flange | C             | E           | Ni           | vertical PCB     |  |
| NL8MPR      | 8    | square G-size flange | C             | D           | Ni           | 3/16" flat tabs* |  |
| NL8MPR-BAG  | 8    | square G-size flange | C             | D           | black chrome | 3/16" flat tabs* |  |
| NLT4MP      | 4    | square G-size flange | C             | D           | nickel       | 1/4" flat tabs*  |  |
| NLT4MP-BAG  | 4    | square G-size flange | C             | D           | black chrome | 1/4" flat tabs*  |  |
| NLT4MD-V    | 4    | square G-size flange | C             | E           | nickel       | vertical PCB     |  |
| NLT4FP      | 4    | square G-size flange | C             | D           | nickel       | solder contacts  |  |
| NLT4FP-BAG  | 4    | square G-size flange | C             | D           | black chrome | solder contacts  |  |
| NLT8MP      | 8    | square G-size flange | C             | D           | nickel       | 1/4" flat tabs*  |  |
| NLT8MP-BAG  | 8    | square G-size flange | C             | D           | black chrome | 1/4" flat tabs*  |  |

\*: flat tabs to be used with FASTON® connectors or to solder the wire (FASTON® is a trademark of AMP Inc.)

## Accessories



|             |  |
|-------------|--|
| A-Screw-1-8 | Black self tapping PLASTITE® screw 2.9 x 8 for rear panel mount                                      |
| BSL-*       | Coloured bushing for NL4FC   |
| NLFASTON    | FASTON® receptacle for tabs with "positiv lock" for use with NL4MP, NL4MPR, NL8MPR, Pack of 100 pcs. |
| MFD         | M3 mounting frame for D-size chassis   |
| NDL         | Dummy plug for 2 & 4 Pole chassis connector  |
| SCL         | Plastic sealing cover to protect the connectors against dust and moisture                            |
| SCDR        | Rear end protection cover for D-size chassis connectors  |
| SCDX        | Hinged cover seals D-size chassis connectors, IP42 rated   |





PCB solder pins



Locking key



## Speakon® Combo



NLJ2MD-V



Combines a Speakon® and 1/4" Phone Jack - one for two

- D-size flange
- Compatible PCB layout and panel mount to NL4MD-V-1 (NL4MD-H)
- Cost saving - combines two connectors in one housing
- Mates with all 2, 4-pole Speakon® and 1/4" Phone Plugs
- PA-wiring: 1+ is connected to TIP, 1- to the SLEEVE

NLJ2MD-V

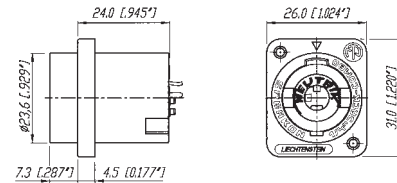

## Ordering Information

|          |  |
|----------|--|
| NLJ2MD-V | 2 pole Chassis Connector, vertical PCB mount   |
| NLJ2MD-H | 2 pole Chassis Connector, horizontal PCB mount |

## Assessories

|             |   |
|-------------|---|
| A-Screw-1-8 | Black self tapping Plastite® screw 2.9 x 8 for rear panel mount           |
| SCL         | Plastic sealing cover to protect the connectors against dust and moisture |
| SCDX        | D-size hinged cover   |
| MFD         | M3 mounting frame for D-size chassis                                      |



Reinforced locking



Latch lock



XL-solder contacts

## Speakon® STX Series Cable Connectors



NLT4FX-BAG



NLT4MX



NLT8FX

### Features

- Up to 50 A current rating
- Only 3 parts, easy to assemble
- All metal housing
- IP 54 sealing gasket



- ① Easy and extremely precise locking system "Quick Look", reinforced with metal
- ② Improved grip on latch
- ③ 1 piece strain relief, chuck for cables from 9 to 16 mm O.D.
- ④ Extreme rugged "Touring Approved"
- ⑤ Rubber sealing boot
- ⑥ Integrated Design guarantees "Made by Neutrik®"
- ⑦ X-large solder contacts for up to 6 mm<sup>2</sup> (AWG 10) wires

NLT4FX

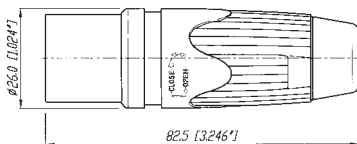

NLT8FX





Robust metal housing



XL-solder contacts

## Speakon® STX Series Chassis Connectors



NLT4FP-BAG



NLT4MP



NLT4MD-V



NLT8MP-BAG

- Extremely robust metal housing designed for harsh and demanding environment
- Weatherproof design features sealing gaskets
- 4 type range - also male cable connector and female receptacle on 4-pole version
- All-metal housing makes the STX Series rugged and durable
- Weatherproof built-in gasket meets IP 54 protection class (4 pole)
- Ideal product for touring applications and harsh environments
- Best electrical performance up to 50 Amps audio current
- Uses precise "Quick Lock" system
- Mates with all currently available Speakon® products
- 4 pole version has UL Recognized components, CSA listed

### NLT4FP

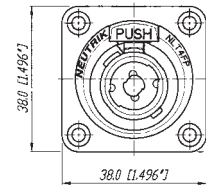
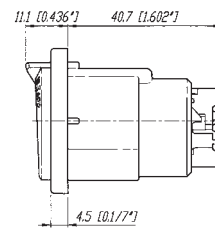

### NLT4MP

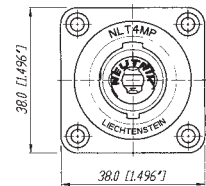
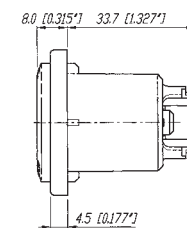

### NLT8MP

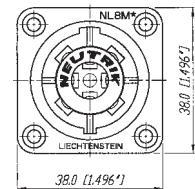
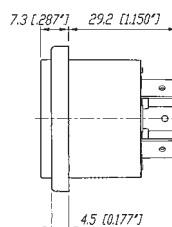

## Design Criteria

The new Speakon® STX Series is the next generation of 4 & 8 pole Speakon® connectors especially designed for loudspeaker - amplifier applications in harsh and demanding environment such as professional touring.

The STX Series features a metal housing which is extremely

rugged and durable; built-in gaskets make it weatherproof. This new series offers beside the female cable connector and male receptacle now also a 4 pole male cable and female chassis connector.

## Ordering Information

### Cable Connectors

|            |  |
|------------|--|
| NLT4FX     | 4 pole female cable connector, nickel metal housing, chuck and bushing       |
| NLT4FX-BAG | 4 pole female cable connector, black-chrome metal housing, chuck and bushing |
| NLT4MX     | 4 pole male cable connector, nickel metal housing, chuck and bushing         |
| NLT4MX-BAG | 4 pole male cable connector, black-chrome metal housing, chuck and bushing   |
| NLT8FX     | 8 pole female cable connector, nickel metal housing, chuck and bushing       |
| NLT8FX-BAG | 8 pole female cable connector, black-chrome metal housing, chuck and bushing |

### Receptacles

|            |  |
|------------|--|
| NLT4FP     | 4 pole female chassis connector, nickel metal housing, solder contacts       |
| NLT4FP-BAG | 4 pole female chassis connector, black-chrome metal housing, solder contacts |
| NLT4MP     | 4 pole male chassis connector, nickel metal housing, 1/4" flat tabs*         |
| NLT4MP-BAG | 4 pole male chassis connector, black-chrome metal housing, 1/4" flat tabs*   |
| NLT4MD-V   | 4 pole male chassis connector, nickel metal housing, PCB contacts            |
| NLT8MP     | 8 pole male chassis connector, nickel metal housing, 1/4" flat tabs*         |
| NLT8MP-BAG | 8 pole male chassis connector, black-chrome metal housing, 1/4" flat tabs*   |

\*: flat tabs to be used with FASTON® connectors or to solder the wire (FASTON® is a trademark of AMP Inc.)

## Accessories



A-Screw-1-8



SCNLT



Example: SCNLT + NL4MP



SCL



NDL

|             |  |
|-------------|--|
| A-Screw-1-8 | Black self tapping Plastite® screw 2.9 x 8 for rear panel mount  |
| SCNLT       | Gasket for NLT4MP<br>(To make a cabinet with an Amphenol EP cutout airtight, the rubber scaling covers the entire hole.) |
| SCL         | Plastic sealing cover to protect the connectors against dust and moisture  |
| NDL         | Dummy plug for 4 Pole chassis connector  |

| Specification | SPX<br>Series<br>Cable Con. | STX<br>Series<br>Cable Con. | Speakon®<br>FC<br>Cable Con. | Speakon®<br>Chassis +<br>Combo | Adapter | STX<br>Series<br>Chassis |
|---------------|-----------------------------|-----------------------------|------------------------------|--------------------------------|---------|--------------------------|
|---------------|-----------------------------|-----------------------------|------------------------------|--------------------------------|---------|--------------------------|

## Electrical

|                                       |                                  |       |         |         |         |       |         |
|---------------------------------------|----------------------------------|-------|---------|---------|---------|-------|---------|
| Number of contacts:                   | 4                                | 4 + 8 | 2, 4, 8 | 2, 4, 8 | 2, 4, 8 | 4 + 8 |         |
| Rated current per contact:            | 40 A rms continuous              | ●     | ●       | 30 A    | 30 A    | 15 A  | ●       |
|                                       | 50 A audiosignal, duty cycle 50% | ●     | ●       | 40 A    | 40 A    | 30 A  | ●       |
| Combo:                                | 15 A rms continuous              | -     | -       | -       | ●       | -     | -       |
| Rated insulation voltage:             | 250 V ac                         | ●     | ●       | ●       | ●       | ●     | ●       |
| Contact resistance after lifetime:    | < 2 mΩ                           | ●     | ●       | ≤ 3     | ≤ 3     | ≤ 3   | ●       |
| Insulation resistance after dampheat: | > 1 GΩ                           | ●     | > 10 GΩ | ●       | ●       | ●     | > 10 GΩ |
| Dielectric strength:                  | 4 kV peak                        | ●     | ●       | ●       | ●       | ●     | ●       |
| 1/4" Jack:                            | 1.5 kV peak                      | -     | -       | -       | -       | ●     | -       |

## Mechanical

|                               |  |                |                |                |        |   |   |
|-------------------------------|--|----------------|----------------|----------------|--------|---|---|
| Locking System:               | Quick lock (latch)                         | ●              | ●              | ●              | ●      | ● | ● |
| Life time (mating cycles):    | > 5'000                                    | ●              | ●              | ●              | ●      | ● | ● |
| Cable O.D. range:             | mm   |                |                |                |        |   |   |
| 2 Pole                        |  | -              | -              | 6 - 10         | -      | - | - |
| 4 Pole                        |  | 7 - 14,5       | -              | 5 - 15         | -      | - | - |
| 8 Pole                        |  | -              | 8 - 20         | 8 - 20         | -      | - | - |
| Wiring:                       | screw type terminals                       | 4 mm² (AWG 12) | -              | 4 mm² (AWG 12) | ● (ST) | - | - |
|                               | soldering                                  | 6 mm² (AWG 10) | 6 mm² (AWG 10) | 4 mm² (AWG 12) | ●      | - | ● |
|                               | flat tabs for 3/16" FASTON® (4.8 x 0.5 mm) | -              | -              | -              | ●      | - | - |
|                               | flat tabs for 1/4" FASTON® (6.3 x 0.8 mm)  | -              | -              | -              | ● (UC) | - | ● |
|                               | PCB-version                                | -              | -              | -              | ●      | ● | ● |
| Insertion / withdrawal force: | Combo Jack: ≤ 20 N / > 10 N                | -              | -              | -              | -      | ● | - |
| Cable retention force:        | ≥ 220 N*                                   | ●              | ●              | ●              | -      | - | - |
| Solderability:                | complies with IEC 68-2-20                  | ●              | ●              | ●              | ●      | ● | ● |

\*: subject to cable O.D. and material

## Material

|                  |                         |   |   |   |        |   |        |
|------------------|-------------------------|---|---|---|--------|---|--------|
| Housing:         | Polyamide PA 6 30% GR   | - | - | ● | ●      | ● | -      |
|                  | PBTP 20% GR             | ● | - | - | -      | - | -      |
|                  | Zinc diecast (ZnAlCu1)  | - | ● | - | -      | - | ●      |
| Insert:          | Polyamide PA 6 30% GR   | - | ● | - | -      | ● | ●      |
|                  | PBTP 20% GR             | ● | - | ● | -      | - | -      |
| Contacts:        | Brass (CuZn39Pb3)       | ● | ● | ● | -      | - | -      |
|                  | Bronze (CuSn6)          | - | - | - | ●      | ● | -      |
|                  | Spring copper           | - | ● | - | ● (UC) | - | ●      |
| Contact plating: | 4 μm Ag                 | ● | ● | ● | ●      | ● | ●      |
| Locking Element: | Zinc diecast (ZnAl4Cu1) | ● | ● | ● | -      | - | ● (FP) |
| Chuck:           | Polyacetal (POM)        | ● | ● | ● | -      | - | -      |
| Bushing:         | Polyamide (PA 6 15% GR) | ● | ● | ● | -      | - | -      |

## Environment

|                      |                             |   |        |   |   |   |        |
|----------------------|-----------------------------|---|--------|---|---|---|--------|
| Temperature range:   | -30°C to +80°C              | ● | ●      | ● | ● | ● | ●      |
| Protection class:    | IP 54 (mated condition)     | - | ●      | - | - | - | ●      |
|                      | IP 52 (8-pole, mated cond.) | - | ●      | - | - | - | ●      |
| Flammability:        | UL94HB                      | ● | ●      | ● | ● | ● | ●      |
| Safety Requirements: | EN/IEC 61984                | ● | ●      | ● | ● | ● | ●      |
| Approvals:           | UL-Recognized, CSA listed   | ● | 4 pole | ● | ● | ● | 4 pole |

## Wiring Suggestion

Positive signal on speaker pin "+" produces positive wave-form from driver (moves cone outwardly)

"+" = In phase (high) "-" = Ground (out of phase, low)  
Lower numbers for lower frequencies.

|                              | AMPLIFIER   | CABLE   | SPEAKER   |
|------------------------------|---|---|---|
| <b>Stereo ("HiFi")</b>       | one NL4MP socket<br>left channel pins 1+/1-<br>right channel pins 2+/2-   | NL4FC on amplifier end, four conductor cable splits into two pairs with NL4FX on each end | one NL4MP per speaker<br>left speaker pins 1+/1-<br>right speaker pins 2+/2-  |
| <b>POWER ("PA") Standard</b> | three NL4MP sockets<br>"A" socket:<br>left channel pins 1+/1-<br>"B" socket:<br>right channel pins 1+/1-                                    | a two-conductor cable for each channel with NL4FX on both ends                            | NL4MP pins 1+ to speaker coil "+"<br>NL4MP pins 1- and 2+ to speaker coil "-"   |
| <b>Bridged mono</b>          | "M" socket:<br>left channel pins 1+/1-<br>right channel pins 2+/2-  | a special two-conductor cable, on both ends wired to pin 1+/2+ of NL4FX                   | NL4MP pin 1+ to speaker coil "+"<br>NL4MP pins 1- and 2+ to speaker coil "-"  |
| <b>Bi-Amp</b>                | one NL4MP socket<br>low frequency pins 1+/1-<br>high frequency pins 2+/2-   | a four-conductor cable on both ends wired to pins 1+/1-, 2+/2- of NL4FX                   | one NL4MP socket<br>low frequency pins 1+/1-<br>high frequency pins 2+/2-   |
| <b>4 Way System</b>          | one NL8MPR socket<br>low frequency pins 1+/1-<br>low mid frequency pins 2+/2-<br>high mid frequency pins 3+/3-<br>high frequency pins 4+/4- | an eight-conductor cable wired on both ends to pins 1+/1-, 2+/2-, 3+/3-, 4+/4- of NL8FC   | one NL8MPR socket<br>low frequency pins 1+/1-<br>low mid frequency pins 2+/2-<br>high mid frequency pins 3+/3-<br>high frequency pins 4+/4- |





## Data Connectors

## Content

## Page

|  |    |   |    |
|--|----|---|----|
| OpticalCon® - Cable Connector Assembly ..... | 65 | EtherCon® - CAT6 .....                              | 77 |
| OpticalCon® - Chassis Connector .....        | 66 | Technical Data EtherCon® - CAT6 .....               | 78 |
| OpticalCon® - Coupler .....                  | 66 | Ordering Information EtherCon® - CAT6 .....         | 78 |
| Technical Data OpticalCon® .....             | 68 | USB and Firewire Adapter .....                      | 79 |
| Ordering Information OpticalCon® .....       | 70 | Technical Data USB and Firewire Adapter .....       | 80 |
| EtherCon® - Cable Carrier .....              | 72 | Ordering Information USB and Firewire Adapter ..... | 80 |
| EtherCon® - Receptacles .....                | 73 |   |    |
| Technical Data EtherCon® .....               | 75 |   |    |
| Ordering Information EtherCon® .....         | 76 |   |    |

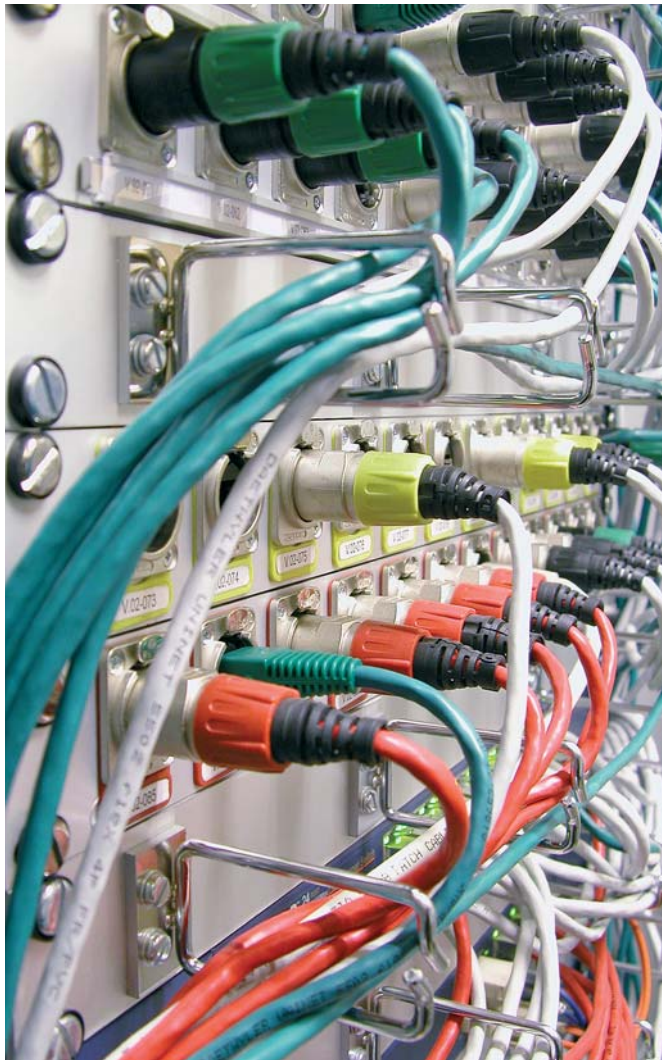

## Introduction

Neutrik's data connector range copes with the increasing demand of digital connections in the professional audio and entertainment industry. Digitalization in the audio business for networking and computerized controls requires also reliable and rugged interconnection systems. Neutrik® early understood this trend and realized Pro Audio proof connector systems based on standard digital interconnection products like fiber optic, Ethernet, USB or Firewire. The Neutrik® data connector line fulfils the stringent requirements of the Pro Audio market and offers ruggedized and reliable optical and RJ45 cable and chassis connectors as well as USB and Firewire panel mount connectors.

Example of EtherCon® RJ45 Data Connector.



## Design Criteria

During the past few years signal digitalization found its way into the Pro Audio & Entertainment business, revolutionizing equipment and applications. Nowadays one fiber optic cable can transmit hundreds of channels, is light and easy to pass, and avoids grounding problems or noises.

The weak spot has been again the connector. Fragile fiber optic network connectors like the ST, SC, LC etc. are optimized for a one time permanent connection but can not meet the rough requirements of the entertainment industry. Military extended beam lens coupling connectors are very expensive and have the disadvantage of an extensive attenuation increase.

Neutrik®, as Pro Audio & Video technology leader when it comes to connectors, kept up with the time and developed a suitable fiber optic connection system - the OpticalCon®.

The system is based on a standardized optical LC-Duplex connection but eliminates its weakness and guarantees a safe and rugged connection.

Because of the compatibility with conventional LC connectors it offers the choice of using a cost effective LC connector as a permanent connection (e.g. patch cable) or our rugged OpticalCon® cable connector for mobile applications. The system enables a run of up to 4 copper wires for power supply or any data signal, a special SMPTE-version has been optimized for broadcast applications and offers an additional ground-shell contact. The chassis connector acts as "feed through" and guarantees a simple installation by simply connecting a conventional LC-Duplex connector (e.g. with a permanent installation cable) on the rear.

The cable connector comes pre-assembled onto a choice of mobile field cables, currently 5 types and their variations (Multimode, Singlemode, APC) can be offered in any length.



Rugged metal housing



Cable drum

## Cable Connector Assembly

**NEW  
IP65**



NKO2M-4S75

- Ruggedized and dirt protected fiber optic connection system
- Waterproof acc. to IP65
- Cable connector comes pre-assembled with a choice of five mobile field cables
- Range of cables include rugged hybrid (fiber + 4 copper wires), robust and lightweight mobile field cable with 2 multi- or singlemode fibers, a 4 pole Y-split and a SMPTE type cable
- Accommodates standard optical LC-Duplex connectors
- Cable connector features rugged all metal housing and heavy duty cable retention
- Excellent dust and dirt protection due to automatic sealing shutter with silicone gasket
- Reliable Push-Pull locking mechanism
- Easy to clean, no tools required
- Cable packed in case, on drum or air spool
- Field repairable

### NKO2M-4S75\*

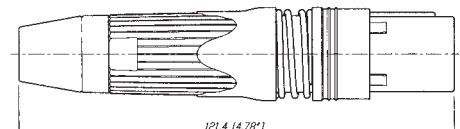



Rear LC connection



Sealed housing



Coloured coding to identify fiber mode



## Chassis Connector

**NEW**  
IP65



NO2-4FDW

- Designed as feedthrough with automatic sealing shutter
- Shutter with silicone gasket protects optical connection from dust and dirt
- Waterproof acc. to IP65 ingress protection
- Rubber sealing gasket (black, blue, green)
- Accommodates standard LC connectors on the rear for simple installation
- Connection on the front side either by rugged OpticalCon® or standard LC connector
- Colour coding to identify fiber mode
  - Multimode – black
  - Singlemode PC – blue
  - Singlemode APC – green

## Coupler

**NEW**  
IP65



NAO2S-4S75W

- OpticalCon® coupler (adapter) in „D“ size housing for cable extensions
- Available in three versions - LC-Duplex multi and single mode (PC and APC) all with 4 copper wires

NAO2M-4S75W

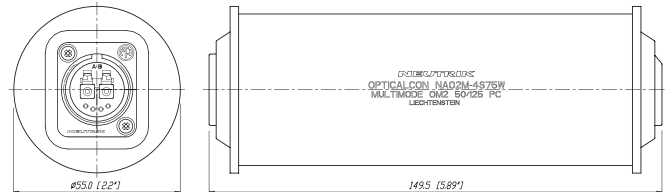

NO2-4FDW

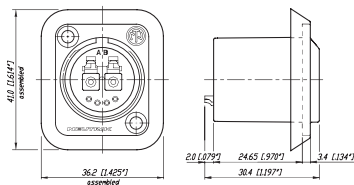

## Features and Benefits

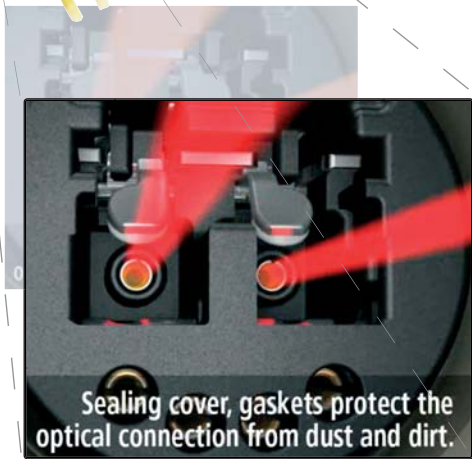

## Technical Data OpticalCon® Connectors

| Optical                       |                         |  | Cable Connector | Chassis Connector     |
|-------------------------------|-------------------------|--|-----------------|-----------------------|
| Optical connector             |                         |  | LC-Duplex       | LC-Duplex Feedthrough |
| Fiber                         |                         | Multimode, Singlemode PC, Singlemode APC | ●               | ●                     |
| Insertion loss                |                         | < 0.5 dB / connection                    | ●               | ●                     |
| Mechanical                    |                         |  |                 |                       |
| Insertion / withdrawal force  |                         | < 45 N                                   | ●               | ●                     |
| Lifetime                      |                         | > 1'000 cycles                           | ●               | ●                     |
| Cable retention force         | 2M-4S75                 | 500 N                                    | ●               | -                     |
|                               | 2S/2M                   | 500 N                                    | ●               | -                     |
|                               | SMPTE                   | 350 N                                    | ●               | -                     |
|                               | 4 MY                    | 300 N                                    | ●               | -                     |
| Electrical                    |                         |  |                 |                       |
| Number of electrical contacts |                         |  | 4               | 4 (5)                 |
| Rated current                 |                         | 6 A                                      | NKO2M-4S75*     | ●                     |
|                               |                         | 10 A (contact 1+4)                       | NKO2S(A)-SMPTE* | ●                     |
| Contact resistance            |                         | < 7 mΩ                                   | ●               | ●                     |
| Insulation resistance         | - initial:              | > 10 GΩ                                  | ●               | ●                     |
|                               | - after damp heat test: | > 1 GΩ                                   | ●               | ●                     |
| Dielectric strength           |                         | 1500 V dc                                | ●               | ●                     |
| Rated voltage                 |                         | 50 V ac                                  | ● <sup>1</sup>  | ● <sup>1</sup>        |
| Material                      |                         |  |                 |                       |
| Shell                         | Zinc diecast (ZnAl4Cu1) | (hard Nickel or Ruthenium plating)       | ●               | ●                     |
| Insert / Insulation           |                         | Polyamid PA 6, PBT 30% GR, PBT 50% GR    | ●               | ●                     |
| Contacts                      | - male:                 | Brass (CuZn39Pb3)                        | ●               | -                     |
|                               | - female:               | Bronze (CuSn6)                           | -               | ●                     |
| Contact surface               |                         | Gold (gal 0.2 μm Au over 2 μm Ni)        | ●               | ●                     |
| Strain relief                 |                         | POM (brass)                              | ●               | -                     |
| Bushing                       |                         | ZnAl4Cu1                                 | ●               | -                     |
| Boot                          |                         | EPDM, rubber boot                        | ●               | -                     |
| Slit sleeve                   |                         | ceramics                                 | -               | ●                     |

### Environmental

|   |                |                      |   |   |
|---|----------------|----------------------|---|---|
| Operating temperature                   | -25°C to +75°C | flammability UL94 HB | ● | ● |
| Solderability complies with IEC 68-2-20 |                |                      | ● | ● |

<sup>1</sup> ... Not compatible to SMPTE 304M standard. Suitable for indoor (studio) camera links considering specific conditions acc. to IEC 60664-1 like pollution degree 1, overvoltage category 1 and rated voltage. For detailed information ask for the White Paper "OpticalCon @ SMPTE Indoor Applications".

## Technical Data Fiber Cables

|                   |           | 2M         | 2S        | 2SA       | 4MY        | 2M-4S75    | 2S-S1      | 2SA-S1     |
|-------------------|-----------|------------|-----------|-----------|------------|------------|------------|------------|
| Attenuation:      | @ 850 nm  | 3 dB/km    |           |           | 3.5 dB/km  | 2.5 dB/km  |            |            |
|                   | @ 1300 nm | 1 dB/km    |           |           | 1.5 dB/km  | 0.7 dB/km  |            |            |
|                   | @ 1310 nm |            | 0.5 dB/km | 0.5 dB/km |            |            | 0.45 dB/km | 0.45 dB/km |
|                   | @ 1550 nm |            | 0.5 dB/km | 0.5 dB/km |            |            | 0.5 dB/km  | 0.5 dB/km  |
| Bandwidth:        | @ 850 nm  | 500 MHz-km |           |           | 500 MHz-km | 500 MHz-km |            |            |
|                   | @ 1300 nm | 500 MHz-km |           |           | 500 MHz-km | 500 MHz-km |            |            |
|                   | @ 1310 nm |            |           |           |            |            |            |            |
|                   | @ 1550 nm |            |           |           |            |            |            |            |
| Refraction index: | @ 850 nm  | 1.468      |           |           | 1.468      | 1.482      |            |            |
|                   | @ 1300 nm | 1.468      |           |           | 1.468      | 1.477      |            |            |
|                   | @ 1310 nm |            | 1.458     | 1.458     |            |            | 1.468      | 1.468      |
|                   | @ 1550 nm |            | 1.458     | 1.458     |            |            | 1.468      | 1.468      |



## Technical Data Mobile Fiber Cables



|                     | 2M           | 2S            | 2SA            | 4MY           |
|---------------------|--------------|---------------|----------------|---------------|
| Number of Fibers    | 2            | 2             | 2              | 4             |
| Fiber type          | Multimode    | Singlemode    | Singlemode     | Multimode     |
| Core diameter       | 50 µm        | 9 µm          | 9 µm           | 50 µm         |
| Cladding diameter   | 125 µm       | 125 µm        | 125 µm         | 125 µm        |
| Copper wires        | -            | -             | -              | -             |
| Outer shield        | -            | -             | -              | -             |
| Strength member     | -            | -             | -              | -             |
| Cable retention     | Aramid yarn  | Aramid yarn   | Aramid yarn    | Aramid yarn   |
| Overall diameter    | 5 mm         | 5 mm          | 5 mm           | 9.5 mm        |
| Jacket              | PUR          | PUR           | PUR            | PUR           |
| Optical connector   | LC-Duplex    | LC-Duplex     | LC-Duplex      | 2 x LC-Duplex |
| Type                | Multimode    | Singlemode PC | Singlemode APC | Multimode     |
| Colour              | black, matte | black, matte  | black, matte   | black, matte  |
| Min. bending radius | 4 cm         | 4 cm          | 4 cm           | 10 cm         |
| Weight              | 23 kg/km     | 23 kg/km      | 23 kg/km       | 103 kg/km     |
| Wiring              |              |               |                |               |

## Technical Data Mobile Hybrid Cables



|                     | 2M-4S75                           | 2S-S1               | 2SA-S1              |
|---------------------|-----------------------------------|---------------------|---------------------|
| Number of Fibers    | 2                                 | 2                   | 2                   |
| Fiber type          | Multimode                         | Singlemode          | Singlemode          |
| Core diameter       | 50 µm                             | 9 µm                | 9 µm                |
| Cladding diameter   | 125 µm                            | 125 µm              | 125 µm              |
| Copper wires        | 4 x AWG 18 (0.75mm <sup>2</sup> ) | 2 x AWG 24 + AWG 16 | 2 x AWG 24 + AWG 16 |
| Outer shield        | -                                 | Copperbraid-Tinned  | Copperbraid-Tinned  |
| Strength member     | GFK                               | Stainless Steel     | Stainless Steel     |
| Cable retention     | Aramid yarn                       | Crimp type          | Crimp type          |
| Overall diameter    | 8.9 mm                            | 9.2 mm              | 9.2 mm              |
| Jacket              | PUR                               | PVC                 | PVC                 |
| Optical connector   | LC-Duplex                         | LC-Duplex           | LC-Duplex           |
| Type                | Multimode                         | Singlemode PC       | Singlemode APC      |
| Colour              | black, matte                      | black, matte        | black, matte        |
| Min. bending radius | 10 cm                             | 10 cm               | 10 cm               |
| Weight              | 78 kg/km                          | 118 kg/km           | 118 kg/km           |
| Wiring              |                                   |                     |                     |

## Ordering Information

### Coding of Mobile Cables

Find a convenient OpticalCon® part number generator on [www.neutrik.com](http://www.neutrik.com)

**N K O 2 M - 4 S 7 5 - R - 1 F - 1 5 0** (Example)

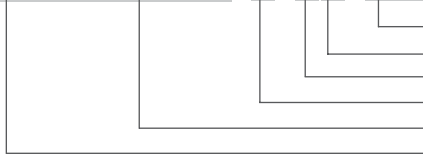

Length [m]

Gender: No suffix ... Male-Male; F ... Male-Female

Packaging 0 to 4

Plating: No suffix ... hard Nickel; R ... Ruthenium

Cable (Assembled)

Neutrik® Optical Cable

### Gender

Male-Male



Standard product (two cable ends)

Male-Female



wired chassis connector for cable extension (one cable end)

### Cable

Field cable + copper

2 pole field cable

SMPTE cable

4 pole Y-split cable

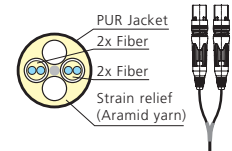
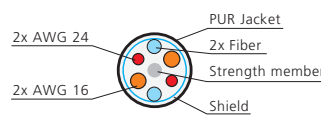
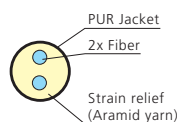
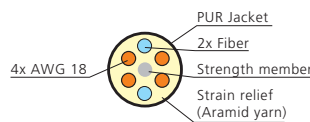

|                        | Field cable + copper  | 2 pole field cable | SMPTE cable          | 4 pole Y-split cable |
|------------------------|-----------------------|--------------------|----------------------|----------------------|
| Multimode PC (black)   | 2M-4S75 <sup>2)</sup> | 2M                 | -                    | 4MY <sup>1) 2)</sup> |
| Singlemode PC (blue)   | -                     | 2S                 | 2S-S1 <sup>2)</sup>  | -                    |
| Singlemode APC (green) | -                     | 2SA                | 2SA-S1 <sup>2)</sup> | -                    |

<sup>1)</sup> ...Gender: Male-male only (no suffix)

### Packaging

0 ... Airspool



1 ... OpticalCon Case



2 ... Drum Schill GT310



3 ... Drum Schill GT380



4 ... Drum Schill HT582



<sup>2)</sup> ...Packaging "2" not possible

### Chassis Connectors

| Chassis Connectors | Colour | Plating     | Fiber | Solder contacts | Shell ground contact |
|--------------------|--------|-------------|-------|-----------------|----------------------|
| NO2-4FDW           | *      | hard Nickel | 2 x   | 4 x             | -                    |
| NO2-4FDW-R         | *      | Ruthenium   | 2 x   | 4 x             | -                    |
| NO2-4FDW-1         | *      | hard Nickel | 2 x   | 4 x             | 1 x                  |
| NO2-4FDW-1-R       | *      | Ruthenium   | 2 x   | 4 x             | 1 x                  |

\* ... Coloured labeling to indicate the fiber mode included.

### Coupler

| Coupler      | Colour (fiber mode) | Plating | Fiber                    | Copper wire              |
|--------------|---------------------|---------|--------------------------|--------------------------|
| NAO2M-4S75W  | black               | black   | LC-Duplex Multimode PC   | 4 x 0.75 mm <sup>2</sup> |
| NAO2S-4S75W  | blue                | black   | LC-Duplex Singlemode PC  | 4 x 0.75 mm <sup>2</sup> |
| NAO2SA-4S75W | green               | black   | LC-Duplex Singlemode APC | 4 x 0.75 mm <sup>2</sup> |



## Accessories



NDO



SCDR



SCDX



Field repair toolkit

|                      |   |
|----------------------|---|
| NDO                  | Dummy plug for OpticalCon chassis connector                               |
| SCDR                 | Rear end protection cover for D-size chassis connectors                   |
| SCDX                 | Hinged cover seals D-size chassis connectors, IP42 rated                  |
| Field repair toolkit | find more details on <a href="http://www.neutrik.com">www.neutrik.com</a> |

## OpticalCon® Wiring and hook up suggestion

In order to achieve uniform and compatible systems we recommend to follow the hook up suggestions of the ISO / IEC 11801 which defines channel A (right) as input and B (left) as output.

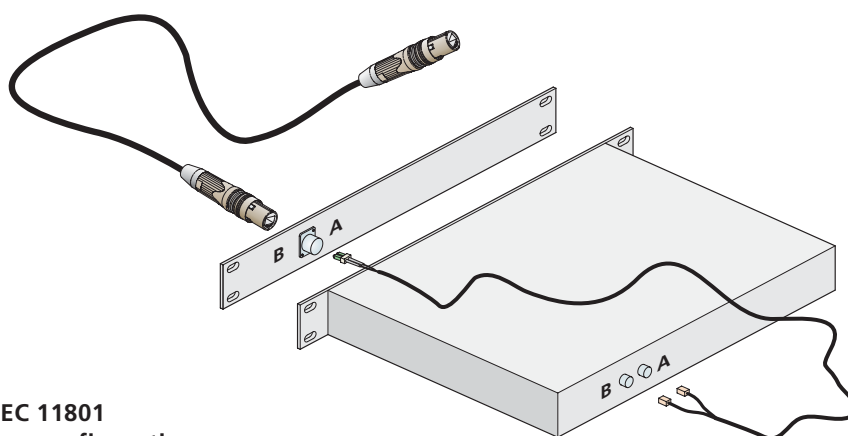

### Extract of the ISO / IEC 11801 Patch cord termination configuration

It is recommended that connection of patch cords and equipment cords to the duplex adapter be made by means of a duplex connector assembly.

Optical fibre patch cords, whether they are used for cross-connection or interconnection to equipment, shall be of a cross-over orientation such that Position A goes to Position B on one optical fibre, and Position B goes to Position A on the other optical fibre of the optical fibre pair (Figure 17). Each end of the optical fibre patch cord shall be identified to indicate Position A and Position B if the connector can be separated into its simplex components. For alternate connector designs utilising latches, the latch defines the positioning in the same manner as the keys.

For simplex connectors, the connector that plugs into the receiver shall be considered Position A, and the connector that plugs into the transmitter shall be considered Position B.



Figure 17 - Optical

Legend:



= Connector



= Position "A"



= Position "B"

Note: Shading for clarification only

## Ruggedized RJ45 Data Connector

Ethercon® provides solutions for data transfer in harsh and demanding applications. These connectors are especially applicable for Ethernet networking in audio, commercial, entertainment, live stage production, DMX lighting, industrial and outdoor internet access environments.

The Ethercon® series offers male cable carriers, assembled female receptacles, feedthrough jacks, cable coupler and shielded versions with or without illumination possibilities by LEDs. The male cable end offers a rugged diecast metal shell as a carrier for pre-assembled RJ45 plugs, which does not require the re-termination of the cable assembly. Female chassis receptacles are based on the current Neutrik® "A & B" series as well the "D" series of XLR receptacles with secure latching system - a feature not found on other RJ45 receptacles. Terminations include horizontal and vertical PCB or IDC. Colour coding is available for both the cable carriers and the receptacles for ease of identification.

Neutrik® Ethercon® receptacles comply with CAT5e (IDC versions) or Class D (PCB versions), shielded or unshielded according to TIA / EIA 586B and ISO / EC 11801 standard.

### EtherCon chassis overview

|                    | Class D   | CAT 5e                 | CAT 6                |
|--------------------|---|------------------------|----------------------|
|                    | Fastethernet<br>10/100 Base-T                   | Gigabit<br>1000 Base-T | 10 Gigabit<br>(IP54) |
| <b>PCB mount</b>   | NE8FAV<br>NE8FBV<br>NE8FDV<br>NE8FAH<br>NE8FBH* | NE8FDH-C5E             |                      |
| <b>IDC</b>         |   | NE8FAV-Y*<br>NE8FDV-Y* | NE8FDY-C6            |
| <b>Feedthrough</b> |   | NE8FDP<br>NE8FF        |                      |



Rugged diecast shell



Bushing

## Cable Carriers



NE8MC + BSE\*



NE8MC-1 + BSE\*

- The RJ45 system for harsh and demanding environment
- Cable connector carrier accepts the most common RJ45 plugs
- Cable carrier has rugged diecast shell and unique chuck type strain relief
- NE8MC-1 version with weatherproof Collinox plating and O-ring gasket
- Protects Ethernet connections in a variety of commercial type applications and is designed to prevent breakage of the fragile components of standard RJ45 connectors
- Cable carrier does not include RJ45 plug

### NE8MC

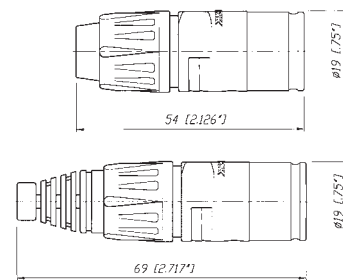

### NE8MC-1

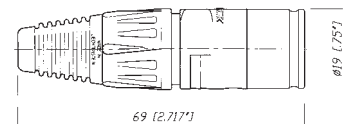





Horizontal PCB



Vertical PCB



IDC Terminals

## Receptacles



NE8FAV + ACRF-2



NE8FBH



NE8FAV-YK



NE8FDV



NE8FDV-Y110-B



NE8FDH-C5E

- "A / B" and "D" sized receptacles available in vertical and horizontal PCB or IDC terminations
- Accommodates NE8MC carriers or any standard RJ45 Plug
- D-versions with unified metal flange equal to "D" series- XLR, Speakon®, PowerCon® and BNC Bulkhead

- Receptacles comply with Class D (PCB versions) or CAT 5e (IDC versions and NE8FDH-C5E) according to TIA / EIA 568B and ISO / IEC 11801 standard
- D-versions mountable from the front or rear of the panel
- Version with screw domes to fix connector onto PCB securely (NE8FAV-SD)

NE8FAV

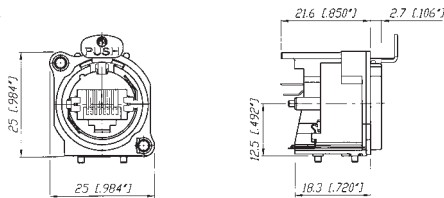

NE8FAV-SD

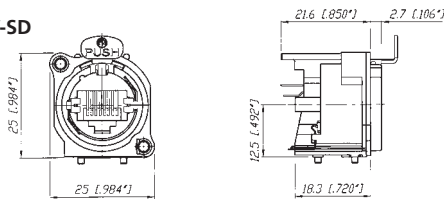

NE8FBH

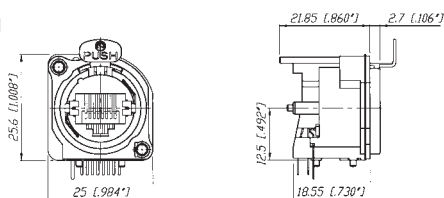

NE8FAV-YK

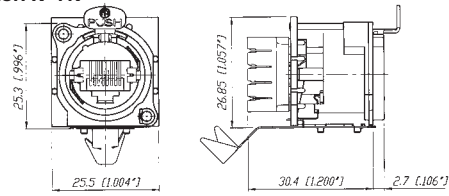

NE8FAV-Y110

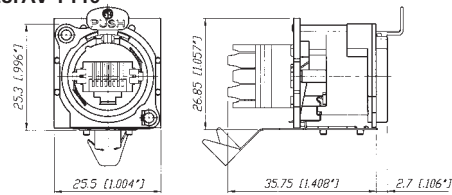

NE8FDV

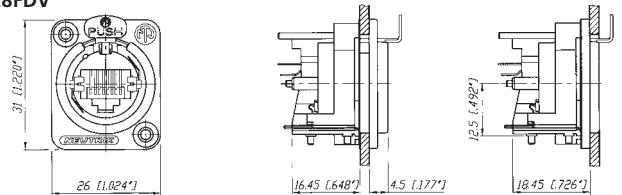



Completely closed housing



Light pipe



NE8FDP rear side



Locking latch

## Shielded & Lighted



NE8FBH-S



NE8FBH-LED

- Comprehensive shielding granted by completely closed metal housing
- Improves EMC performance of appliance even in unmated condition
- Lighted version offers in addition various illuminating indication possibilities by means of two separate light pipes
- Light pipes illuminated by standard 3 mm LEDs - to be mounted on PCB by customer

## Feedthrough



NE8FDP



NE8FF

- Feedthrough as panel mount receptacle and as cable coupler
- NE8FDP feedthrough connector in D series housing for use in patchfields - rear side accommodates standard RJ45 plug
- NE8FF coupler (adapter) for cable to cable mating - use with NE8MC carriers or any standard RJ45 plugs

### NE8FBH-S

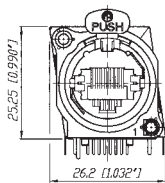

### NE8FBH-LED

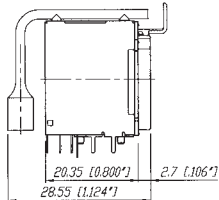
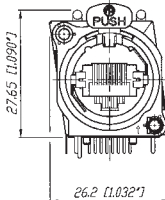

### NE8FDP

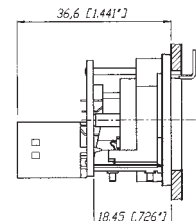

### NE8FF



| Specification                                       |   | NE8MC*<br>Cable Con. | NE8FA/B*<br>(A + B Series) | NE8FD*<br>(D Series) |
|---|---|----------------------|----------------------------|----------------------|
| <b>Electrical</b>                                   |   |                      |                            |                      |
| Number of contacts                                  |   | - <sup>1)</sup>      | 8                          | 8                    |
| Rated current per contact                           | > 1.5 A   | - <sup>1)</sup>      | ●                          | ●                    |
| Rated voltage                                       | < 50 V ac   | - <sup>1)</sup>      | ●                          | ●                    |
| Contact resistance                                  | < 10 mΩ   | - <sup>1)</sup>      | ●                          | ●                    |
| Insulation resistance                               | > 500 MΩ  | - <sup>1)</sup>      | ●                          | ●                    |
| Dielectric strength                                 | > 1'000 V ac rms                                  | - <sup>1)</sup>      | ●                          | ●                    |
| Frequency bandwidth                                 | 1 - 100 MHz                                       | - <sup>1)</sup>      | ●                          | ●                    |
| Transmission class acc. TIA / EIA 568B or IEC 11801 | CAT 5e  | - <sup>1)</sup>      | ●                          | ● NE8FDH-C5E         |
|   | Class D   | - <sup>1)</sup>      | PCB Versions               | PCB Versions         |
|   |   |                      |                            | NE8FDV               |
| <b>Mechanical</b>                                   |   |                      |                            |                      |
| Retention method                                    | latch lock  | ●                    | ●                          | ●                    |
| Life time (mating cycles)                           | > 1'000 mating cycles                             | ●                    | ●                          | ●                    |
|   | > 200 mating cycles                               | -                    | -                          | SE8FD                |
| Insertion / withdrawal force                        | ≤ 20 N  | ●                    | ●                          | ●                    |
| Cable O.D. range                                    | 3.5 - 8 mm  | ●                    | -                          | -                    |
| Wire size   | AWG 26 - 20                                       | - <sup>1)</sup>      | NE8*-Y*                    | NE8*-Y*              |
| Panel thickness                                     | max. 3 mm / 0.12"                                 | -                    | ●                          | 4 mm / 0.16"         |
| <b>Material</b>                                     |   |                      |                            |                      |
| Housing   | PBT D202G30                                       | -                    | ●                          | ●                    |
|   | Zinc diecast (ZnAlCu1, gal Ni / bl Cr / Collinox) | ●                    | -                          | -                    |
| B / D-flange  | Zinc diecast (ZnAlCu1, gal Ni / bl Cr)            | -                    | ●                          | ●                    |
| Strain relief clamp                                 | POM   | ●                    | -                          | -                    |
|   | CuZn35Pb2, Tin plated                             | -                    | NE8*-Y*                    | NE8*-Y*              |
| Contacts  | Bronze (CuSn6)                                    | - <sup>1)</sup>      | ●                          | ●                    |
| Contact surface                                     | Au (gal 0.2 μm over Ni plating)                   | - <sup>1)</sup>      | ●                          | ●                    |
| Locking Element                                     | Ck 67 steel, treated                              | -                    | ●                          | ●                    |
| Bushing   | Polyamide (PA 6 15% GR)                           | ●                    | -                          | -                    |
| Boot  | Polyamide (PA 6)                                  | ●                    | -                          | -                    |
| Sealing gasket                                      | EPDM  | -                    | -                          | SE8FD                |
| <b>Environment</b>                                  |   |                      |                            |                      |
| Operating Temperature                               | -30°C to +80°C                                    | ●                    | ●                          | ●                    |
|   | -20°C to +60°C                                    | -                    | -                          | SE8FD                |
| Protection class                                    | IP54  | -                    | -                          | SE8FD                |
| Flammability  | UL94 HB   | ●                    | ●                          | ●                    |
| Solderability complies with IEC 68-2-20             |   | -                    | PCB Version                | PCB Version          |
| Mating screw  |   | -                    | A screw                    | E screw              |
| Colour coding                                       |   | BSE-* / BSX-*        | ACRF-*                     | DSS-*                |

<sup>1)</sup>...Specs depend on type of RJ45 plugs used

## Ordering Information

### Cable Connector

|            |  |
|------------|--|
| NE8MC      | Cable housing with chuck and bushing (two antikink boots, one up to 5 mm and one up to 8 mm cable O.D.) (standard bushing in black, 9 different coding colours on request)                 |
| NE8MC-B    | Black chromium housing with chuck and bushing (two antikink boots, one for 5 mm and one for 8 mm cable O.D.) (standard bushing in black, 9 different coding colours on request)            |
| NE8MC-1    | Cable housing with chuck and X-series bushing, Collinox plating and O-ring gasket (perfect for waterproof applications) (standard bushing in black, 9 different coding colours on request) |
| NE8MC-B-1  | Black chromium housing with chuck and X-series bushing (standard bushing in black, 9 different coding colours on request)  |
| IMPORTANT: | Cable connectors do not include RJ 45 plug. RJ 45 cable assembly must be provided by end-user!   |

| Receptacle                                       | A-shape (all plastic) | B-shape (Nickel ring) | D-shape       |
|--|-----------------------|-----------------------|---------------|
| Horizontal PCB                                   | NE8FAH                | NE8FBH                |               |
| Vertical PCB                                     | NE8FAV                | NE8FBV                | NE8FDV        |
| Vertical PCB with additional screw domes         | NE8FAV-SD**           |                       |               |
| IDC terminals                                    | NE8FAV-YK**           |                       | NE8FDV-YK**   |
| IDC 110 punch down terminals                     | NE8FAV-Y110**         |                       | NE8FDV-Y110** |
| Horizontal PCB with metal housing (shielded)     |                       | NE8FBH-S              |               |
| Horizontal PCB in CAT5e                          |                       |                       | NE8FDH-C5e    |
| Horizontal PCB with metal housing and light pipe |                       | NE8FBH-LED            |               |

\*\* ... includes 2 mounting screws

### Feedthrough

|        |   |
|--------|---|
| NE8FDP | Receptacle (includes 2 mounting screws) |
| NE8FF  | Coupler                                 |

### Accessories

|  |  |   |   |   |  |   |   |
|--|--|---|---|---|--|---|---|
|                             |     |  |  |  |  |  |  |
| A screw  | E screw  | E screw Nickel  | ACRF-*  | DSS-*   | BSE-*  | BSX-*   | SCDX  |
| A-Screw  | Mounting screw for A / B -shape (black self-tapping PLASTITE® screw 2.9 x 8, panhead)  |   |   |   |  |   |   |
| E-Screw  | Mounting screw for D-shape (black self-tapping PLASTITE® screw 2.9 x 12, countersunk)  |   |   |   |  |   |   |
| E-Screw-Ni   | Mounting screw for D-shape (Nickel self-tapping PLASTITE® screw 2.9 x 12, countersunk) |   |   |   |  |   |   |
| ACRF-*   | Coloured coding rings for A-shape receptacles (Box of 100 pcs.)                        |   |   |   |  |   |   |
| BSE-*  | Coloured boot for cable connector carrier (Box of 100 pcs.)                            |   |   |   |  |   |   |
| BSX-*  | Coloured bushing for NE8MC-1 and NE8MC-B-1 cable connectors                            |   |   |   |  |   |   |
| DSS-*  | Lettering plate for D series, coloured plastic   |   |   |   |  |   |   |
| SCDX   | Hinged cover seals D-size chassis connectors, IP42 rated                               |   |   |   |  |   |   |
| *: 0 - Black, 1 - Brown, 2 - Red, 3 - Orange, 4 - Yellow, 5 - Green, 6 - Blue, 7 - Violet, 8 - Grey, 9 - White |  |   |   |   |  |   |   |

### Waterproof kit for EtherCon® D-Series

|   |  |
|---|--|
|  |  |
| Waterproof assembly kit - SE8FD   |  |
| SE8FD   | Waterproof kit, IP 54, consists of push, gasket, frontplate<br>Suitable for all NE8FD*, perfect in combination with NE8MC-1 (with Collinox plating and sealing gasket) |



D-shape metal shell



Closed shielding



Push Pull locking



IP65 in mated condition

## CAT6 Receptacles



NE8FDY-C6



NE8FDY-C6-B

## CAT6 Patch Cable



NKE6S-\*

- CAT6 compliant - data rate up to 10 GBit/s
- IP 65 rated - with dust and waterproof resistant sealing
- Push Pull mating design provides secure locking system
- Shielded system - high noise immunity and EMI protection
- IDC contacts offer gas-tight termination
- Ready made patch cables with rugged diecast cable carrier and unique chuck-type strain relief

NE8FDY-C6

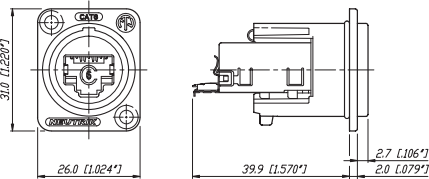

NKE6S-\*

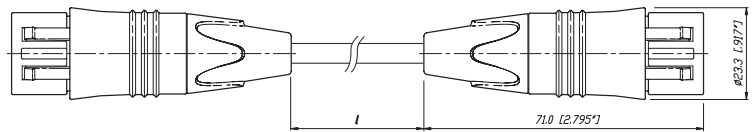

NKE6S-\*-WOC

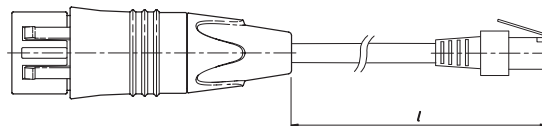

## Design Criteria

The ruggedized RJ45 CAT6 connection system, provides solutions for high bandwidth data transfer in harsh and demanding environments. This series offers additional headroom for high performance Fast Ethernet 100BaseT and Gigabit Ethernet 1000BaseT connectivity in audio, lighting, live stage and industrial environments and even guarantees to be prepared for future 10 Gbit applications (true CAT6). The EtherCon CAT6 series offers a D-shape panel connector with metal housing and secure latching system. Tool-free IDC termination makes cable assembly easy and fast. The preassembled CAT6 patch cables use a shielded S/FTP cable with cable plug carrier offering a robust metal shell and Push-Pull locking system. Integrated sealing rings make the system dust and waterproof to IP 65 rating.

### Features & Benefits:

- CAT6 performance – fast data transmission and high bandwidth applications
- CAT6 specifications according TIA / EIA 568B, ISO / IEC 11801, EN 50173
- Shielded system - high noise immunity and EMI protection
- Push Pull mating - secure and proven locking system
- D-shape metal panel connector
- Ground lead jumper on panel connector with selectable grounding option
- IDC termination without tool
- Ready made patch cables with rugged cable carrier and unique chuck-type strain relief
- Dust and waterproof according IP 65

## Technical Data

| Electrical                  | Receptacle |             | Patch cable |             | Materials            | Receptacle     |                | Patch cable    |                |
|-----------------------------|------------|-------------|-------------|-------------|----------------------|----------------|----------------|----------------|----------------|
|                             | Receptacle | Patch cable | Receptacle  | Patch cable |                      | Receptacle     | Patch cable    | Receptacle     | Patch cable    |
| Number of contacts:         | 8          | 8           | 8           | 8           | Housing:             | Zinc diecast   | Zinc diecast   | Zinc diecast   | Zinc diecast   |
| Rated current per contact:  | 1.5 A      | 1.5 A       | 1.5 A       | 1.5 A       | Adapter:             | Polyamide PA 6 | Polyamide PA 6 | Polyamide PA 6 | Polyamide PA 6 |
| TIA / EIA rating:           | CAT6       | CAT6        | CAT6        | CAT6        | Strain relief clamp: | -              | POM            | -              | POM            |
| Input to output resistance: | < 200 mΩ   | < 200 mΩ    | < 200 mΩ    | < 200 mΩ    | Contacts:            | Bronze CuSn    | Bronze CuSn    | Bronze CuSn    | Bronze CuSn    |
| Insulation resistance:      | > 500 MΩ   | > 500 MΩ    | > 500 MΩ    | > 500 MΩ    | Contact surface:     | Gold           | Gold           | Gold           | Gold           |
| Dielectric strength:        | 1 kV dc    | 1 kV dc     | 1 kV dc     | 1 kV dc     | Bushing:             | -              | PU /PA         | -              | PU /PA         |
| NEXT (250 MHz):             | 48.7 dB    | 48.7 dB     | 48.7 dB     | 48.7 dB     |                      |                |                |                |                |
| Attenuation (250 MHz):      | 0.1 dB     | 0.1 dB      | 0.1 dB      | 0.1 dB      |                      |                |                |                |                |

### Mechanical

|                            |                                 |                        |                |
|----------------------------|---------------------------------|------------------------|----------------|
| Retention method:          | Push-Pull                       | Operating temperature: | -10°C to +60°C |
| Life time (mating cycles): | > 1'000                         | Storage temperature:   | -40°C to +70°C |
| Wire size:                 | 0.5 - 0.65 mm (AWG 24 - AWG 22) | Flammability:          | UL94HB         |
| Stranded wire:             | AWG 26 / 7 - 22 / 7             | Protection class:      | IP 65          |

### Environmental

## Ordering Information

### Patch Cable

|             |   |
|-------------|---|
| NKE6S-*     | Standard lengths: 0.5, 1, 3, 5, 10 m  |
| NKE6S-*-WOC | Equipped on one side with metal shell, standard lengths: 0.5, 1, 3, 5, 10 m<br>Custom length in meter steps on request. |

### Receptacle

|             |   |
|-------------|---|
| NE8FDY-C6   | EtherCon CAT6 with Nickel D-shell       |
| NE8FDY-C6-B | EtherCon CAT6 with Black Chrome D-shell |

# USB and Firewire Adapter



D-shape metal housing



USB type B



D-shape metal housing



IEE 1394 receptacle

## USB



NAUSB

- Ideal for audio networking and integration of computer-based equipment into audio systems
- USB gender changer type A-B (B-A)
- Reversible insert offering type A or B on front or rear end
- Universally accepted standard D-shape housing

## Firewire



NA1394-6-B

- Ideal for audio networking and integration of digital equipment into audio systems
- Firewire feedthrough with 6-pole IEEE 1394 receptacle at both ends
- Universally accepted standard D-shape housing

NAUSB



NA1394-6



## Technical Data

| Mechanical                      |                         | USB                    | Firewire  |
|---------------------------------|-------------------------|------------------------|-----------|
| Insertion / withdrawal force    | < 35 N / > 10 N         | •                      | •         |
| Lifetime                        | > 1'500 cycles          | •                      | •         |
| Electrical                      |                         |                        |           |
| Rated current                   | 1.5 A                   | •                      | •         |
| Contact resistance              | < 30 mΩ (mated pair)    | •                      | •         |
| Insulation resistance           |                         | > 1 GΩ                 | > 100 MΩ  |
| Dielectric withstanding voltage | 500 V ac (1 min)        | •                      | •         |
| Rated voltage                   |                         | < 30 V ac              | < 40 V dc |
| Material                        |                         |                        |           |
| Shell                           | Zinc diecast (ZnAl4Cu1) | Nickel or black Chrome | •         |
| Insert / Insulation             |                         | Polyamid PA 6          | •         |
| Contacts                        |                         | Brass (CuZn39Pb3)      | -         |
| Contact finish                  |                         | Gold                   | •         |
| Shell finish                    |                         | Nickel                 | •         |
| Environmental                   |                         |                        |           |
| Operating temperature           | -25°C to +85°C          | •                      | •         |
| Flammability                    | UL94 V-0                | •                      | •         |

## Ordering Information

### USB

|         |  |
|---------|--|
| NAUSB   | USB A – USB B Adapter (reversible), Nickel housing |
| NAUSB-B | USB A – USB B Adapter (reversible), black housing  |

### Firewire

|             |   |
|-------------|---|
| NA 1394-6   | 6-pole Firewire Adapter (IEEE 1394), Nickel housing |
| NA 1394-6-B | 6-pole Firewire Adapter (IEEE 1394), black housing  |

## Accessories



DSS-\*



SCM



SCDX

|       |   |
|-------|---|
| DSS-* | Lettering plate for D series, coloured plastic                                      |
| SCM   | Plastic sealing cover to protect the Firewire connectors against dust and moisture. |
| SCDX  | Hinged cover seals D-size chassis connectors, IP42 rated                            |

\*: 0 - Black, 1 - Brown, 2 - Red, 3 - Orange, 4 - Yellow, 5 - Green, 6 - Blue, 7 - Violet, 8 - Grey, 9 - White





## **BNC Connectors**

## Content

## Page

|                                  |    |                                |    |
|----------------------------------|----|--------------------------------|----|
| Rear Twist Cable Connectors..... | 83 | Connector to Cable Guide ..... | 90 |
| Push Pull Cable Connectors.....  | 85 | Chassis Connectors .....       | 92 |
| Accessories .....                | 87 | Technical Data .....           | 93 |
| Cable to Connector Guide .....   | 88 |                                |    |

# NEUTRIK® 75 Ω BNC Connectors

Neutrik® offers a variety of 75 Ω cable and chassis BNC connectors. The Push-Pull and RearTwist® cable connectors are easy to handle in high density applications such as video patchbays and switches, provide a tactile and fast assembly and offer colour coding as a standard. All parts of our BNC series are precisely machined to our high quality standards.

## True 75 Ω HDTV Connectors

With the introduction of HD signals the impedance of BNC connectors becomes more important than ever. Every deviate impedance has a negative influence on the „return loss“ / „VSWR“ (Voltage Standing Wave Ratio) which are important measurements for reflected signals in a transmission line. Especially on high frequencies - as they occur when transmitting HD signals (typical transmission @ 2.25 GHz) - an impedance mismatch results in a lot of return loss.

Neutrik's BNC connectors feature a true 75 Ω design that meet the stringent requirements of HDTV and sustain a consistent impedance at high frequencies up to 3 GHz. To achieve this result every Neutrik® BNC connector has been adapted to the measurements of a small group of cables, this guarantees the best possible performance and a little return loss.

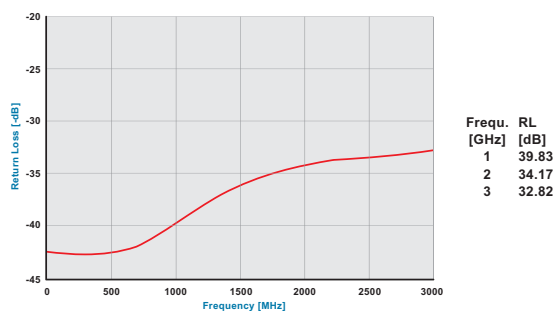

The higher the frequencies the more pronounced is the „skin effect“, which means that the energy moves to the outside of the conductor. Therefore the plating of outer and center contact is more important than on audio connectors with low frequencies - both contacts of our BNC connectors are gold plated.

## Neutrik BNC's - enhanced high frequency shielding!

In times of rising frequencies the connector shielding becomes to an important value in order to avoid EMI problems and crosstalking. Neutrik BNC's take this fact into account and has been equipped with an optimized ground contact design for maximum shielding effectiveness.



Gold plated ground contact with improved shielding effectiveness optimized for high frequency HDTV signal up to 3 GHz.

# Rear Twist Cable Connectors



Bayonet locking



Gold plated contacts



Female cable jack

## Rear Twist® (Standard, Large & Tiny) and Cable Jacks



NBTC75BLI4



NBNC75BLP7



NBNB75GLP9



NBTB75CFI4

- "Rear Twist® Principle" locking/unlocking using the easily accessible soft touch boot (Patent DE 100 48507)
- Ideal for recessed bulkheads where access to the "head" of the connector might be an issue. These connectors turn from the back and not the front.
- True 75  $\Omega$  design meets the stringent HDTV / DVD requirements
- Snug-fit center pin insert provides tactile feedback
- Shield and jacket crimp technology prevents the problem of an exposed grounding braid on cable assemblies
- Excellent cable protection and retention
- Large version for RG 11 cable
- Precise Swiss machined brass parts for outstanding durability
- Accessories include color coded boots in 10 standard colours, crimp tool and dies
- Sleek female cable jack e.g. for Y-cables
- Mountable panel version of cable jack for fixed installations



## Features & Benefits

- Screen and cable jacket crimp instead of screen crimp only.  
Grooved inner surface holds the cable jacket to prevent tearing braids.

- Gold plated ground contact with improved shielding effectiveness optimized for high frequency HDTV signal up to 3 GHz.

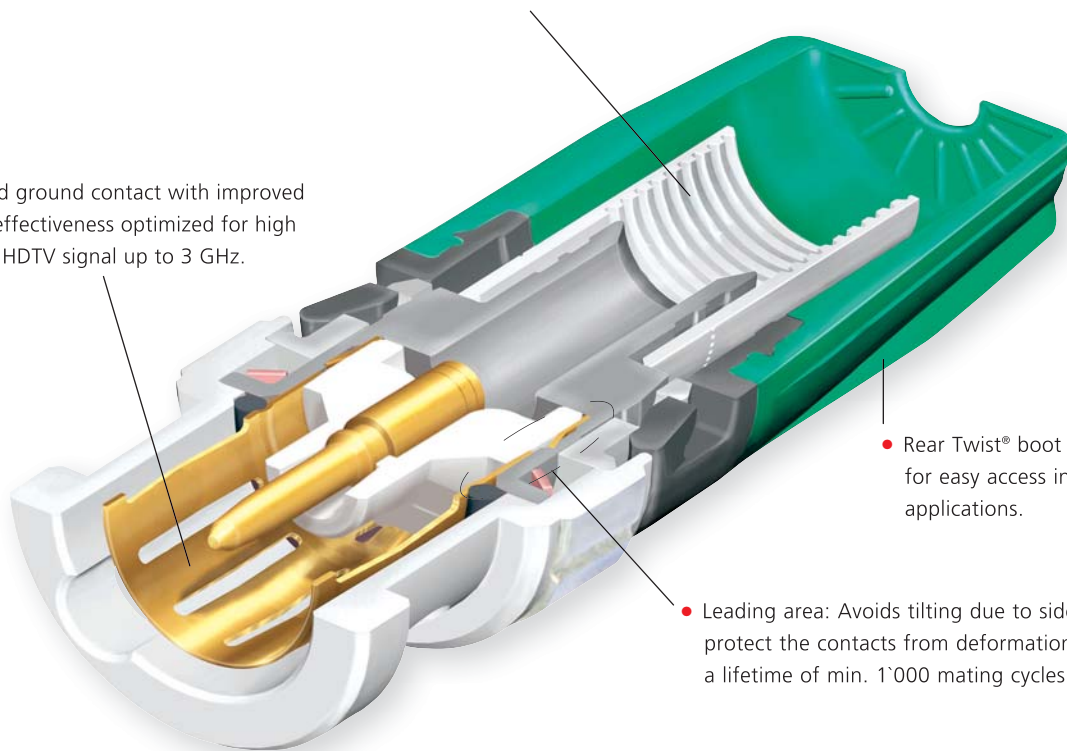

- Rear Twist® boot in 10 colours for easy access in high density applications.

- Leading area: Avoids tilting due to side forces to protect the contacts from deformation. Guarantees a lifetime of min. 1'000 mating cycles!



Neutrik BNC:  
no tilting due to side pull



Other BNC



Push Pull locking



Gold plated contacts

## Push Pull Cable Connectors



NBNC75PTS11



NBNC75PNS7



NBNC75PIE9



NBNC75PLS9

- Unique Push-Pull locking system is ideal for ultra high density applications, patching, etc.
- True 75  $\Omega$  design meets the stringent HDTV / DVD requirements
- Excellent return loss / VSWR data
- Precision machined parts
- Assembly is fast and easy and requires only a standard center contact crimp after cable preparation
- Reusable due to screw lock strain relief
- Snug-fit center pin insert provides tactile feedback
- Only pin crimp, this eliminates the need of different crimp dies and facilitates field repair
- Innovative screw lock cable retention for easy assembly
- Accessories include colour coded boots in 10 standard and 3 translucent colours



## Features & Benefits

- Push Pull sleeve in various colours for easy access in high density applications.
- Neutrik® chuck type strain relief offers flexibility and field repair.
- Gold plated ground contact with improved shielding effectiveness optimized for high frequency HDTV signal up to 3 GHz.
- Leading area: Avoids tilting due to side forces to protect the contacts from deformation. Guarantees a lifetime of min. 1'000 mating cycles!
- Push Pull locking mechanism for convenient handling, perfect for patching applications.



# Accessories



BNC tool case equipped with  
 - HX-R-BNC  
 - PT-BNC: Plier tool  
 - CS-BNC: Stripping tool

CAS-BNC-T

Note: Dies have to be ordered separately.

Crimp tool, frame



HX-R-BNC

Crimp tool die for pin and shield for HX-R-BNC



DIE-R-BNC-\*

## Boots, tools, ...



BST-BNC-\*

Standard boot for the Rear Twist® BNCs in black, 9 different colours available.



BS-BNC-\*

Boot for Push-Pull BNCs in black, 9 different colours available, as well as 3 translucent variants.



HX-BNC

Crimp tool, frame. (heavy duty)



DIE-BNC-\*

Crimp tool die for pin and shield for HX-BNC.



HT-BNC

Spanner tool for the Push-Pull BNCs.



DSS

Lettering plate for D Shape bulkheads.



SCF

Rubber sealing cover to protect the connector against dust and moisture



SCDX

Hinged cover seals D-size chassis connectors, IP42 rated

### Crimp die assignment for HX-BNC

| Crimp die  | Hex crimp<br>mm |      | Hex crimp<br>inch |       | Center pin<br>mm<br>(square crimp) |
|------------|-----------------|------|-------------------|-------|------------------------------------|
|            | A               | B    | A                 | B     |                                    |
| DIE-BNC-CS | 4.06            | 7.01 | 0.160             | 0.276 | 1.6                                |
| DIE-BNC-JD | 5.41            | 4.53 | 0.213             | 0.178 | 1.6                                |
| DIE-BNC-PG | 6.47            | 5.00 | 0.255             | 0.197 | 1.6                                |
| DIE-BNC-U  | 7.36            | -    | 0.290             | -     | 1.6                                |
| DIE-BNC-UG | 7.36            | 5.00 | 0.290             | 0.197 | 1.6                                |
| DIE-BNC-Y  | 8.23            | -    | 0.324             | -     | 1.6                                |

### Crimp die assignment for HX-R-BNC

| Crimp die     | Hex crimp<br>mm |      |      | Hex crimp<br>inch |       |       | Center pin<br>mm<br>(square crimp) |
|---------------|-----------------|------|------|-------------------|-------|-------|------------------------------------|
|               | A               | B    | C    | A                 | B     | C     |                                    |
| DIE-R-BNC-PDC | 6.47            | 4.53 | 4.06 | 0.255             | 0.178 | 0.160 | 1.6                                |
| DIE-R-BNC-PG  | 6.47            | 5.00 | -    | 0.255             | 0.197 | -     | 1.6                                |
| DIE-R-BNC-PJ  | 6.47            | 5.41 | -    | 0.255             | 0.213 | -     | 1.6                                |
| DIE-R-BNC-PS  | 6.47            | 7.01 | -    | 0.255             | 0.276 | -     | 1.6                                |
| DIE-R-BNC-PU  | 6.47            | 7.36 | -    | 0.255             | 0.290 | -     | 1.6                                |
| DIE-R-BNC-PY  | 6.47            | 8.23 | -    | 0.255             | 0.324 | -     | 1.6                                |
| DIE-R-BNC-Z   | 9.73            | -    | -    | 0.383             | -     | -     | 1.75<br>(Hex crimp)                |

# Cable to Connector Guide

|   | Push Pull   | Rear Twist  | Rear Twist Tiny | Cable Jack Tiny | Cable Jack Panel | Hex Crimp in mm |
|---|-------------|-------------|-----------------|-----------------|------------------|-----------------|
| <b>Belden</b>                               |             |             |                 |                 |                  |                 |
| 1277R, 1278R, 1279R                         |             |             | NBTC75BNN5      |                 |                  | 4.53            |
| 1406B, 1407B, 1417B                         |             |             | NBTC75BVV5      |                 |                  | 5.00            |
| 1426A                                       | NBNC75PLS9  | NBNC75BLP9  |                 |                 | NBNB75GLP9       | 6.47            |
| 1505A (ANH)                                 | NBNC75PLS9  | NBNC75BLP9  |                 |                 | NBNB75GLP9       | 6.47            |
| 1505F                                       | NBNC75PLS9  | NBNC75BJP9  |                 |                 |                  | 6.47            |
| 1506A                                       | NBNC75PIE9  | NBNC75BIJ9  |                 |                 |                  | 5.41            |
| 1520A, 1521A, 1522A, 179DT                  |             |             | NBTC75BFI4      | NBTB75CFI4      |                  | 4.06            |
| 1694A (ANH)                                 | NBNC75PTS11 | NBNC75BTU11 |                 |                 |                  | 7.36            |
| 1694F                                       | NBNC75PTS11 | NBNC75BTY11 |                 |                 |                  | 8.23            |
| 1695A                                       | NBNC75PQS11 | NBNC75BQP11 |                 |                 |                  | 6.47            |
| 1855A                                       | NBNC75PDE6  | NBNC75BDD6  |                 |                 |                  | 4.53            |
| 1865A                                       |             |             | NBTC75BXX6      |                 |                  | 5.00            |
| 1855ENH                                     | NBNC75PFE7  | NBNC75BFG7  |                 |                 |                  | 5.00            |
| 7731A (ANH)                                 |             | NBLC75BVZ17 |                 |                 |                  | 9.73            |
| 8218  |             |             | NBTC75BXX5      |                 |                  | 5.00            |
| 8241  | NBNC75PNS7  | NBNC75BLP7  |                 |                 |                  | 6.47            |
| 8241F                                       | NBNC75PLS9  | NBNC75BLP9  |                 |                 | NBNB75GLP9       | 6.47            |
| 8281  |             | NBNC75BXY9  |                 |                 |                  | 8.23            |
| 8281F                                       |             | NBNC75BYY9  |                 |                 |                  | 8.23            |
| 9221  |             |             | NBTC75BLI4      |                 |                  | 4.06            |
| <b>CANARE</b>                               |             |             |                 |                 |                  |                 |
| L-4CFB                                      | NBNC75PLS9  | NBNC75BLP9  |                 |                 | NBNB75GLP9       | 6.47            |
| L-5CFB                                      |             | NBNC75BYY11 |                 |                 |                  | 8.23            |
| LV-61S                                      | NBNC75PNS7  | NBNC75BLP7  |                 |                 |                  | 6.47            |
| LV-77S                                      |             | NBNC75BYY9  |                 |                 |                  | 8.23            |
| V(3-5)-3C                                   | NBNC75PGE7  | NBNC75BGG7  |                 |                 |                  | 5.00            |
| V(3-5)-4CFB                                 | NBNC75PLE9  | NBNC75BJJ9  |                 |                 |                  | 5.41            |
| V(3-5)-5C                                   | NBNC75PVS9  | NBNC75BRS9  |                 |                 |                  | 7.01            |
| V(3-5)-5CFB                                 | NBNC75PVS11 | NBNC75BWS11 |                 |                 |                  | 7.01            |
| L-1.5C2VS                                   |             |             | NBTC75BLI4      |                 |                  | 4.06            |
| <b>COMMSCOPE</b>                            |             |             |                 |                 |                  |                 |
| 2065V                                       | NBNC75PIE9  | NBNC75BIJ9  |                 |                 |                  | 5.41            |
| 2279V                                       | NBNC75PQS11 | NBNC75BQP11 |                 |                 |                  | 6.47            |
| 5563  | NBNC75PNS7  | NBNC75BLP7  |                 |                 |                  | 6.47            |
| 5565  | NBNC75PLS9  | NBNC75BLP9  |                 |                 | NBNB75GLP9       | 6.47            |
| 5765  | NBNC75PTS11 | NBNC75BTU11 |                 |                 |                  | 7.36            |
| 7536 (03-05)                                |             |             | NBTC75BXX6      |                 |                  | 5.00            |
| 7538  | NBNC75PDE6  | NBNC75BDD6  |                 |                 |                  | 4.53            |
| <b>CANFORD</b>                              |             |             |                 |                 |                  |                 |
| SDV, SDM                                    | NBNC75PFE7  | NBNC75BFG7  |                 |                 |                  | 5.00            |
| SDV-L, SDV-F                                | NBNC75PVS11 | NBNC75BWS11 |                 |                 |                  | 7.01            |
| SDV-HD                                      |             | NBLC75BVZ17 |                 |                 |                  | 9.73            |
| SDV-F-HD                                    |             | NBNC75BWU13 |                 |                 |                  | 7.36            |
| <b>DRAKA MULTIMEDIA CABLE</b>               |             |             |                 |                 |                  |                 |
| 0.31 / 1.45 AF, 753-1304(2), 755-1302       |             |             | NBTC75BFI4      | NBTB75CFI4      |                  | 4.06            |
| 0.41 / 1.9 AF, 753-1104, 755-1103, 755-1101 |             |             | NBTC75BNN5      | NBTB75CNN5      |                  | 4.53            |
| 0.51 / 2.3 Dz, 757-1001, VADN 7243          |             | NBTC75BVX6  |                 |                 |                  | 5.00            |
| 0.6 / 2.8 AF, 0.6 L / 2.8 AF                | NBNC75PFE7  | NBNC75BFG7  |                 |                 |                  | 5.00            |
| 0.6 / 3.7, 0.6L / 3.7                       | NBNC75PNS7  | NBNC75BLP7  |                 |                 |                  | 6.47            |
| 0.6 / 3.7 Dz                                | NBNC75PNS7  | NBNC75BLS7  |                 |                 |                  | 7.01            |
| 0.8 / 3.7 AF, 755-801(803, 804)             | NBNC75PLS9  | NBNC75BLP9  |                 |                 | NBNB75GLP9       | 6.47            |
| 0.8 / 4.9 Dz                                |             | NBNC75BXY9  |                 |                 |                  | 8.23            |
| 1.0 / 4.8 AF, 755-901/5                     | NBNB75PTS11 | NBNC75BUU11 |                 |                 | NBNB75GUU11      | 7.36            |
| 1.2L / 4.8Dz, 1.2L / 4.95AF                 |             | NBNC75BWU13 |                 |                 |                  | 7.36            |
| 1.4 / 6.6 AF                                |             | NBLC75BSX14 |                 |                 |                  | 9.73            |
| 1.6 / 7.3AF                                 |             | NBLC75BVZ17 |                 |                 |                  | 9.73            |





# Cable to Connector Guide

|                             | Push Pull   | Rear Twist  | Rear Twist Tiny | Cable Jack Tiny | Cable Jack Panel | Hex Crimp in mm |
|-----------------------------|-------------|-------------|-----------------|-----------------|------------------|-----------------|
| <b>GEPCO</b>                |             |             |                 |                 |                  |                 |
| VPM2000                     | NBNC75PLS9  | NBNC75BLP9  |                 |                 | NBNB75GLP9       | 6.47            |
| VSD2001                     | NBNC75PTS11 | NBNC75BTU11 |                 |                 |                  | 7.36            |
| <b>SUHNER</b>               |             |             |                 |                 |                  |                 |
| G02233                      |             |             | NBTC75BFI4      | NBTB75CFI4      |                  | 4.06            |
| G04233D                     | NBNC75PNS7  | NBNC75BLS7  |                 |                 |                  | 7.01            |
| S02223                      |             |             | NBTC75BLI4      |                 |                  | 4.06            |
| S04233, S04263              | NBNC75PLS9  | NBNC75BLP9  |                 |                 | NBNB75GLP9       | 6.47            |
| S05133-07                   | NBNC75PTS11 | NBNC75BTU11 |                 |                 |                  | 7.36            |
| S05163-02                   | NBNC75PTS11 | NBNC75BTU11 |                 |                 |                  | 7.36            |
| <b>OTHERS</b>               |             |             |                 |                 |                  |                 |
| AT&T 735                    |             |             | NBTC75BSS5      |                 |                  | 4.53            |
| COMM-TEC RGBHV              |             |             | NBTC75BSS5      |                 |                  | 4.53            |
| Argosy (Dranka) Image 360   |             | NBNC75BFG7  |                 |                 |                  | 5.00            |
| Argosy (Dranka) Image 720   |             | NBNC75BLP9  |                 |                 |                  | 6.47            |
| Argosy (Dranka) Image 1000  | NBNC75PTS11 | NBNC75BUU11 |                 |                 | NBNB75GUU11      | 7.36            |
| BBC PSF 1/3*                | NBNC75PNS7  | NBNC75BLS7  |                 |                 |                  | 7.01            |
| BESCA France - Bengat       |             |             | NBTC75BNS4      |                 |                  | 4.53            |
| CAE MC75                    |             |             | NBTC75BLI5      | NBTB75CLI5      |                  | 4.06            |
| CAE MC75.39                 |             |             | NBTC75BVX6      |                 |                  | 5.00            |
| CAE KX6A                    | NBNC75PNS7  | NBNC75BLP7  |                 |                 |                  | 6.47            |
| CAE VCB75                   | NBNC75PNS9  | NBNC75BNP9  |                 |                 |                  | 6.47            |
| CAE VCB 100                 |             | NBNC75BXU13 |                 |                 |                  | 7.36            |
| Cordial CVI 3-7             | NBNC75PFE7  | NBNC75BFG7  |                 |                 |                  | 4.53            |
| Cordial CVI 06-28           | NBNC75PFE7  | NBNC75BFG7  |                 |                 |                  | 5.00            |
| Cordial CVI (CVM) 06-37     | NBNC75PNS7  | NBNC75BLP7  |                 |                 |                  | 6.47            |
| COVID CVD 1300-1500         |             |             | NBTC75BLI5      | NBTB75CLI5      |                  | 4.06            |
| Eupen 705 CRT 5V-HS         | NBNC75PTS11 | NBNC75BTS11 |                 |                 |                  | 7.36            |
| Extron BNC-5HR              |             |             | NBTC75BNN5      | NBTB75CNN5      |                  | 4.53            |
| Extron BNC-5RC              | NBNC75PGE7  | NBNC75BFG7  |                 |                 |                  | 5.00            |
| Helix 734                   | NBNC75PNS9  | NBNC75BNP9  |                 |                 |                  | 6.47            |
| Helix 735                   |             |             | NBTC75BSS5      |                 |                  | 4.53            |
| Hirschmann KOKA 712Cu       | NBNC75PTS9  | NBNC75BTS9  |                 |                 |                  | 6.47            |
| Kansai 0.5M3C-2V            | NBNC75PGE7  |             |                 |                 |                  | -               |
| Kansai 3C-5S                | NBNC75PFE6  | NBNC75BFH6  |                 |                 |                  | 5.00            |
| KLOTZ                       |             |             |                 |                 |                  |                 |
| V06/28, VMXx75Y             | NBNC75PFE7  | NBNC75BFG7  |                 |                 |                  | 5.00            |
| V06/37                      | NBNC75PNS7  | NBNC75BLP7  |                 |                 |                  | 6.47            |
| V10/48                      | NBNC75PTS11 | NBNC75BUU11 |                 |                 | NBNB75GUU11      | 7.36            |
| V16/72                      |             | NBLC75BVZ17 |                 |                 |                  | 9.73            |
| KROSCHU (341 270, 341 280)  |             |             | NBTC75BLI4      |                 |                  | 4.06            |
| Nexans                      |             |             |                 |                 |                  |                 |
| HF 75 0.6/2.9 02YS(ST)CH    |             | NBNC75BFG7  |                 |                 |                  | 5.00            |
| HF 75 1.6/7.2 02Y(ST)C(ST)H |             | NBNC75BVZ17 |                 |                 |                  | 9.73            |
| HF 75 0.6/3.7 2YCY          |             | NBNC75BLP7  |                 |                 |                  | 6.47            |
| RG11                        |             | NBLC75BVZ17 |                 |                 |                  | 9.73            |
| RG59B/U                     | NBNC75PNS7  | NBNC75BLP7  |                 |                 |                  | 6.47            |
| RG179B/U                    |             |             | NBTC75BLI4      |                 |                  | 4.06            |
| SOMMER                      |             |             |                 |                 |                  |                 |
| 600-0051 (M/L/S)            | NBNC75PNS7  | NBNC75BLP7  |                 |                 |                  | 6.47            |
| 600-0054 (M/L/S)            | NBNC75PNS7  | NBNC75BLP7  |                 |                 |                  | 6.47            |
| 600-0101M                   | NBNC75PFE7  | NBNC75BFG7  |                 |                 |                  | 5.00            |
| 600-0104M                   | NBNC75PFE7  | NBNC75BFG7  |                 |                 |                  | 5.00            |
| 600-162(F)                  | NBNC75PLS9  | NBNC75BLP9  |                 |                 |                  | 6.47            |
| 600-025* -03 (05)           |             |             | NBTC75BLI5      | NBTB75CLI5      |                  | 4.06            |
| 600-0701                    |             |             | NBTC75BLI5      | NBTB75CLI5      |                  | 4.06            |
| 600-020* -03 (05)           |             |             | NBTC75BLI5      | NBTB75CLI5      |                  | 4.06            |
| 600-0451                    | NBNC75PLS9  | NBNC75BLP9  |                 |                 | NBNB75GLP9       | 6.47            |
| 600-0751                    |             |             | NBTC75BVX6      |                 |                  | 5.00            |
| Wisi MK 99A                 | NBNC75PVS12 | NBNC75BWS12 |                 |                 |                  | 7.01            |
| ZNK CM14B                   |             |             | NBTC75BFI4      | NBTB75CFI4      |                  | 4.06            |

\* Registered trademark of BBC

# Connector to Cable Guide

|   | Pin crimp<br>mm (square) | Hex crimp<br>mm | Inner<br>Conductor | Insulator | Cable O.D. |
|---|--------------------------|-----------------|--------------------|-----------|------------|
| <b>PUSH PULL</b>                              |                          |                 |                    |           |            |
| NBNC75PDE6                                    | 1.6                      | N/A             | < 0.6              | < 2.65    | 4.0 - 5.0  |
| NBNC75PFE6                                    | 1.6                      | N/A             | < 0.6              | < 2.85    | 4.0 - 5.0  |
| NBNC75PFE7                                    | 1.6                      | N/A             | < 0.7              | < 2.85    | 4.0 - 5.0  |
| NBNC75PGE7                                    | 1.6                      | N/A             | < 0.7              | < 3.2     | 4.0 - 5.0  |
| NBNC75PIE9                                    | 1.6                      | N/A             | < 0.9              | < 3.5     | 4.0 - 5.0  |
| NBNC75PLE9                                    | 1.6                      | N/A             | < 0.9              | < 3.65    | 4.0 - 5.0  |
| NBNC75PLS9                                    | 1.6                      | N/A             | < 0.9              | < 3.65    | 6.0 - 7.0  |
| NBNC75PNS7                                    | 1.6                      | N/A             | < 0.7              | < 3.75    | 6.0 - 7.0  |
| NBNC75PNS9                                    | 1.6                      | N/A             | < 0.9              | < 3.75    | 6.0 - 7.0  |
| NBNC75PQS11                                   | 1.6                      | N/A             | < 1.1              | < 4.3     | 6.0 - 7.0  |
| NBNC75PTS9                                    | 1.6                      | N/A             | < 0.9              | < 4.6     | 6.0 - 7.0  |
| NBNC75PTS11                                   | 1.6                      | N/A             | < 1.1              | < 4.6     | 6.0 - 7.0  |
| NBNC75PVS9                                    | 1.6                      | N/A             | < 0.9              | < 4.9     | 6.0 - 7.0  |
| NBNC75PVS11                                   | 1.6                      | N/A             | < 1.1              | < 4.9     | 6.0 - 7.0  |
| NBNC75PVS12                                   | 1.6                      | N/A             | < 1.2              | < 4.9     | 6.0 - 7.0  |
| <b>REAR TWIST</b>                             |                          |                 |                    |           |            |
| NBLC75BVZ17                                   | 1.75 (Hex crimp)         | 9.73            | < 1.7              | < 8.0     | < 10.4     |
| NBLC75BSX14                                   | 1.75 (Hex crimp)         | 9.73            | < 1.4              | < 6.6     | < 9.5      |
| NBNC75BDD6                                    | 1.6                      | 4.53            | < 0.6              | < 2.8     | < 4.3      |
| NBNC75BFG7                                    | 1.6                      | 5.00            | < 0.7              | < 3.1     | < 4.7      |
| NBNC75BFH6                                    | 1.6                      | 5.00            | < 0.6              | < 3.1     | < 4.9      |
| NBNC75BGG7                                    | 1.6                      | 5.00            | < 0.7              | < 3.2     | < 4.7      |
| NBNC75BIJ9                                    | 1.6                      | 5.41            | < 0.9              | < 3.6     | < 5.3      |
| NBNC75BIJ9                                    | 1.6                      | 5.41            | < 0.9              | < 3.8     | < 5.3      |
| NBNC75BJP9                                    | 1.6                      | 6.47            | < 0.9              | < 3.8     | < 6.3      |
| NBNC75BLP7                                    | 1.6                      | 6.47            | < 0.7              | < 3.8     | < 6.3      |
| NBNC75BLP9                                    | 1.6                      | 6.47            | < 0.9              | < 3.8     | < 6.3      |
| NBNC75BLS7                                    | 1.6                      | 7.01            | < 0.7              | < 3.8     | < 6.9      |
| NBNC75BNP9                                    | 1.6                      | 6.47            | < 0.9              | < 4.1     | < 6.3      |
| NBNC75BQP11                                   | 1.6                      | 6.47            | < 1.1              | < 4.5     | < 6.3      |
| NBNC75BRS9                                    | 1.6                      | 7.01            | < 0.9              | < 4.8     | < 6.9      |
| NBNC75BTS9                                    | 1.6                      | 7.01            | < 0.9              | < 4.7     | < 6.9      |
| NBNC75BTS11                                   | 1.6                      | 7.01            | < 1.1              | < 4.7     | < 6.9      |
| NBNC75BTU11                                   | 1.6                      | 7.36            | < 1.1              | < 4.7     | < 7.3      |
| NBNC75BUU11                                   | 1.6                      | 7.36            | < 1.1              | < 4.7     | < 7.3      |
| NBNC75BTY11                                   | 1.6                      | 8.23            | < 1.1              | < 4.7     | < 8.0      |
| NBNC75BWS11                                   | 1.6                      | 7.01            | < 1.1              | < 5.1     | < 6.9      |
| NBNC75BWS12                                   | 1.6                      | 7.01            | < 1.2              | < 5.1     | < 6.9      |
| NBNC75BWU13                                   | 1.6                      | 7.36            | < 1.4              | < 5.1     | < 7.3      |
| NBNC75BXU13                                   | 1.6                      | 7.36            | < 1.4              | < 5.1     | < 7.3      |
| NBNC75BXY9                                    | 1.6                      | 8.23            | < 0.9              | < 5.1     | < 8.0      |
| NBNC75BYY9                                    | 1.6                      | 8.23            | < 0.9              | < 5.2     | < 8.0      |
| NBNC75BYY11                                   | 1.6                      | 8.23            | < 1.1              | < 5.2     | < 8.0      |
| <b>REAR TWIST TINY</b>                        |                          |                 |                    |           |            |
| NBTC75BFI4                                    | 1.6                      | 4.06            | < 0.4              | < 1.6     | < 2.9      |
| NBTC75BLI4                                    | 1.6                      | 4.06            | < 0.4              | < 1.8     | < 2.9      |
| NBTC75BLI5                                    | 1.6                      | 4.06            | < 0.5              | < 1.8     | < 2.9      |
| NBTC75BNN5                                    | 1.6                      | 4.53            | < 0.5              | < 2.0     | < 3.1      |
| NBTC75BNS4                                    | 1.6                      | 4.53            | < 0.4              | < 2.0     | < 3.5      |
| NBTC75BSS5                                    | 1.6                      | 4.53            | < 0.5              | < 2.3     | < 3.4      |
| NBTC75BVV5                                    | 1.6                      | 5.00            | < 0.5              | < 2.5     | < 3.8      |
| NBTC75BVX6                                    | 1.6                      | 5.00            | < 0.6              | < 2.5     | < 4.0      |
| NBTC75BXX5                                    | 1.6                      | 5.00            | < 0.5              | < 2.6     | < 4.0      |
| NBTC75BXX6                                    | 1.6                      | 5.00            | < 0.6              | < 2.6     | < 4.0      |
| <b>CABLE JACKS (TINY &amp; PANEL VERSION)</b> |                          |                 |                    |           |            |
| NBTB75CFI4                                    | 1.6                      | 4.06            | < 0.4              | < 1.6     | < 2.9      |
| NBTB75CNS5                                    | 1.6                      | 4.53            | < 0.5              | < 2.0     | < 3.1      |
| NBTB75CLI5                                    | 1.6                      | 4.06            | < 0.5              | < 1.8     | < 2.9      |
| NBNB75GLP9                                    | 1.6                      | 6.47            | < 0.9              | < 3.8     | < 6.3      |
| NBNB75GUU11                                   | 1.6                      | 7.36            | < 1.1              | < 4.9     | < 7.3      |
| NBNB75ILP9                                    | 1.6                      | 6.47            | < 0.9              | < 3.8     | < 6.3      |
| NBNB75IUU11                                   | 1.6                      | 7.36            | < 1.1              | < 4.9     | < 7.3      |



## Cable Type

Belden 1855A; CommScope 7538  
 Kansai 3C-5S  
 Belden 1855ENH; Cordial CVI 06-28, CVI 3-7; Canford SDM, SDV-LFH; Draka 0.6/2.8 AF, 0.6L/2.8 AF; Sommer 600-0101M, 600-0104M, KLOTZ V06/28, VMXx75Y  
 Canare V(3-5)-3C; Extron BNC-5RC  
 Belden 1506A; CommScope 2065V  
 Canare V(3-5)-4CFB  
 Belden 1505A (ANH), Belden 1505F; 8241F; CommScope 5565; Canare L-4CFB; Draka 0.8/3.7 AF, 755-801 (803,804); Gepco VPM2000; Suhner S04263; Sommer 600-0451, 600-162(F), 804  
 Belden 8241; BBC PSF 1/3, CAE KX6A; CommScope 5563; Cordial CVI (CVM) 06-37; Suhner G04233D; Canare LV-61S; RG59B/U; Draka 0.6/3.7, 0.6/3.7 Dz, 0.6L/3.7;  
 Sommer 600-0051 (M,L,S), 600-0054 (M,L,S), KLOTZ V06/37  
 CAE VCB75; Helix 734  
 Belden 1695A; CommScope 2279V  
 Hirschmann KOKA 712Cu  
 Belden 1694A (ANH), 1694F; CommScope 5765; Draka 1.0/4.8 AF, 755-901/5, Argosy (Draka) Image 1000; Eupen 705 CRT 5V-HS; Gepco VSD2001; Suhner S05133-07 S05163-02, KLOTZ V10/48  
 Canare V(3-5)-5C  
 Canare V(3-5)-5CFB; Canford SDV-F, SDV-L  
 Wisi MK 99A

Belden 7731A (ANH); Canford SDV-HD; Draka 1.6/7.3AF; KLOTZ V16/72; RG11; Nextans HF 75 1.6/7.2 02Y(ST)C(ST)H  
 Draka 1.4 / 6.6 AF  
 Belden 1855A; CommScope 7538  
 Argosy (Draka) Image 360; Belden 1855ENH; Canford SDM, SDV-S-LFH; Cordial CVI 06-28, CVI 3-7; Draka 0.6/2.8 AF, 0.6L/2.8 AF; Extron BNC-5RC;  
 Sommer 600-0101M, 600-0104M, KLOTZ V06/28, VMXx75Y; Nexans HF 75 0.6/2.9 02YS(ST)CH  
 Kansai 3C-5S  
 Canare V(3-5)-3C  
 Belden 1506A; CommScope 2065V  
 Canare V(3-5)-4CFB  
 Belden 1505F  
 Belden 8241; CAE KX6A; Canare LV-61S; Cordial CVI (CVM) 06-37; CommScope 5563; Draka 0.6/3.7, 0.6L/3.7 ; RG59B/U; Sommer 600-0051 (M,L,S), 600-0054 (M,L,S),  
 KLOTZ V06/37; Nextans HF 75 0.6/3.7 2YCY  
 Argosy (Draka) Image 720; Belden 1505A (ANH), 8241F; Canare L-4CFB; CommScope 5565; Draka 0.8/3.7 AF, 755-801 (803, 804); Gepco VPM2000; Suhner S0426;  
 Sommer 600-0451, 600-162(F)  
 BBC PSF 1/3; Draka 0.6/3.7 Dz, 755-801 (803, 804); Suhner G04233D (PTT 6010)  
 CAE VCB75; Helix 734  
 Belden 1695A; CommScope 2279V  
 Canare V(3-5)-5C  
 Hirschmann KOKA 712Cu  
 Eupen 705 CRT 5V-HS  
 Belden 1694A (ANH); CommScope 5765; Gepco VSD2001; Suhner S05163-02, 05133-07  
 Belden 1694A; CommScope 5765; Gepco VSD2001; Suhner S05163-02, 05133-07; Argosy (Draka) Image 1000  
 Belden 1694F  
 Canare V(3-5)-5CFB; Canford SDV-L, SDV-F  
 Wisi MK 99A  
 Canford SDV-F-HD; Draka 1.2L/4.8Dz, 1.2L/4.95AF  
 CAE VCB 100  
 Belden 8281; Draka 0.8/4.9Dz  
 Belden 8281F; Canare LV-77S  
 Canare L-5CFB

Belden 1520A, 1521A, 1522A, 179DT; Draka 0.31/1.45 AF, 753-1304(2), 755-1302; Suhner G02233, ZNK CM14B  
 Canare L-1.5C2VS; Suhner S02223; Kroschu (341 270, 341 280); RG 179 B/U; Sommer 600-025-03 (05)  
 CAE MC75; Procom; Sommer 600-0701, 600-20-03 (05), 600-025-03 (05)  
 Belden 1277R, 1278R, 1279R; Draka 0.41/1.9AF, 753-1104, 755-1103; Extron BNC-5 HR(P) (Bulk), BNC-5RC  
 TESCA France - Bengat  
 AT&T 735; CommTech RGBHV  
 Belden 1406B, 1407B, 1417B  
 CAE NC75.39; Draka 755-1001 (0.51/2.3Dz), 757-1001; Sommer 600-0751; VADN 7243  
 Belden 8218  
 Belden 1865A; CommScope 7536

Belden 1520A, 1521A, 1522A, 179DT; Draka 0.31/1.45 AF, 753-1304(2), 755-1302; Suhner G02233; ZNK CM14B  
 Draka 0.41/1.9 AF, 753-1104, 755-1101; 755-1103; Extron BNC 5 HR(P) (Bulk)  
 CAE MC75; Sommer 600-0701, 600-20-03 (05), 600-025-03 (05)  
 Belden 1505A, 8241F; Canare L-4CFB; CommScope 5565; Draka 0.8/3.7 AF, 755-801 (803, 804); Gepco VPM2000; Suhner S04263; Sommer 600-0451  
 Draka 1.0/4.8AF, 755-901/5, Argosy (Draka) Image 1000, KLOTZ V10/48  
 Belden 1505A, 8241F; Canare L-4CFB; CommScope 5565; Draka 0.8/3.7 AF, 755-801 (803, 804); Gepco VPM2000; Suhner S04263; Sommer 600-0451  
 Draka 1.0/4.8AF, 755-901/5, Argosy (Draka) Image 1000, KLOTZ V10/48



D-shape metal housing



Gold plated center pin

## Bulkhead Jacks



NBB75FI



NBB75DFG



NBB75DFGB



NBB75SI

- True 75  $\Omega$  design meets the stringent HDTV / DVD requirements
- Isolated or grounded versions
- "D" shaped housing (provides flush mounting and protection of the jacks from damage) or single feed through mountings
- Gold plated center contact

**NBB75DFG**

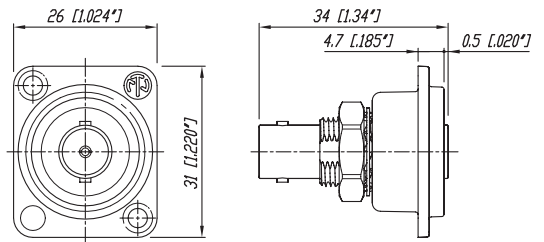

**NBB75FI**

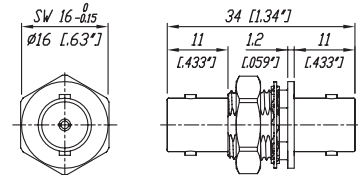

## Ordering Information

|  | Nickel housing | Black housing |
|--|----------------|---------------|
| Bulkhead jack, D-shape housing, feed through, grounded     | NBB75DFG       | NBB75DFGB     |
| Bulkhead jack, D-shape housing, feed through, isolated     | NBB75DFI       | NBB75DFIB     |
| Bulkhead jack, D-shape housing, solder version, grounded   | NBB75DSG       | NBB75DSGB     |
| Bulkhead jack, D-shape housing, solder version, isolated   | NBB75DSI       | NBB75DSIB     |
| Bulkhead jack, feed through, grounded                      | NBB75FG        |               |
| Bulkhead jack, feed through, isolated                      | NBB75FI        |               |
| Bulkhead jack, solder version, including isolation washers | NBB75SI        |               |



# Technical Specifications

| Specifications |  | Rear Twist® & Rear Twist Large & Cable Jack Panel | Rear Twist® Tiny & Cable Jack Tiny | Push Pull | Bulkheads |
|----------------|--|---|------------------------------------|-----------|-----------|
|----------------|--|---|------------------------------------|-----------|-----------|

## Electrical

|                                 |                               |   |                              |   |                              |
|---------------------------------|-------------------------------|---|------------------------------|---|------------------------------|
| Impedance                       | 75 Ω                          | • | •                            | • | •                            |
| Rated voltage                   | 500 V ac rms                  | • | 250 V ac rms                 | • | •                            |
| Insulation resistance           | > 5 GΩ                        | • | •                            | • | •                            |
| Dielectric withstanding voltage | 1500 V ac rms                 | • | 750 V ac rms                 | • | •                            |
| VSWR / Return Loss              | ≤ 1.050 / > 32 dB up to 1 GHz | • | ≤ 1.10 / > 26 dB up to 1 GHz | • | ≤ 1.03 / > 37 dB up to 1 GHz |
|                                 | ≤ 1.065 / > 30 dB up to 2 GHz | • | ≤ 1.14 / > 24 dB up to 2 GHz | • | ≤ 1.05 / > 32 dB up to 2 GHz |
|                                 | ≤ 1.100 / > 26 dB up to 3 GHz | • | ≤ 1.22 / > 20 dB up to 3 GHz | • | ≤ 1.08 / > 28 dB up to 3 GHz |
| Inner contact resistance        | ≤ 3 mΩ (initial)              | • | •                            | • | •                            |
| Outer contact resistance        | ≤ 2 mΩ (initial)              | • | •                            | • | •                            |

## Mechanical

|  |                          |                   |                |                          |            |
|--|--------------------------|-------------------|----------------|--------------------------|------------|
| Cable anchoring                        | Jacket crimping          | •                 | •              | Neutrik® chuck principle | N / A      |
| Cable O.D. range<br>- Rear Twist Large | mm                       | 4.0 - 7.7<br>10.3 | 2.5 - 3.8<br>- | 4.0 - 8.0<br>-           | N / A<br>- |
|  | Center contact retention | > 30 N            | •              | •                        | -          |
| Engagement force                       | < 25 N                   | •                 | •              | < 20 N                   | •          |
| Lifetime                               | 1'000 mating cycles      | •                 | •              | •                        | •          |

## Environmental

|                      |   |   |   |                |       |
|----------------------|---|---|---|----------------|-------|
| Temperature range    | -30°C to +85°C                          | • | • | -30°C to +40°C | •     |
| Solderability        | Complies with IEC 68-2-20               | • | • | •              | N / A |
| Contact crimpability | Complies with IEC 60803 and IEC 60352-2 | • | • | •              | N / A |

## Materials

|   |       |       |       |       |
|---|-------|-------|-------|-------|
| Shell: Brass (CuZn39Pb3), OPTALLOY coated                           | •     | •     | •     | •     |
| PA6 (Push Pull only)  | N / A | N / A | •     | N / A |
| D-Shape housing: Zinc diecast (ZnAl4Cu1) gal Ni or black Cr plating | N / A | N / A | N / A | •     |
| Ground contact:   |       |       |       |       |
| Bronze (CuSn6), 0.2 μm AuCo over 2 μm NiP15                         | •     | •     | •     | -     |
| Brass (CuZn39Pb3), OPTALLOY coated                                  | -     | -     | -     | •     |
| Center contact:   |       |       |       |       |
| Brass (CuZn35Pb2), 0.2 μm AuCo or                                   | •     | •     | •     | -     |
| Brass (CuZn39Pb3), 0.2 μm AuCo                                      | -     | -     | -     | •     |
| Insulator: Teflon PTFE  | •     | •     | •     | •     |
| Chuck: Polyacetal POM   | N / A | N / A | •     | N / A |
| Insulation Shell: Polyacetal POM                                    | N / A | N / A | N / A | •     |

## Center Contact:

| I.D. in mm | Materials         | Plating   | Coding Ring (# of rings on base of contact) |
|------------|-------------------|-----------|---|
| 0.4        | Brass (CuZn39Pb3) | 2 μm AuCo | 0   |
| 0.5        | •                 | •         | 5   |
| 0.6        | •                 | •         | 1   |
| 0.7        | •                 | •         | 2   |
| 0.9        | •                 | •         | 3   |
| 1.1        | •                 | •         | 6   |
| 1.2        | •                 | •         | 4   |
| 1.7        | •                 | •         | 0   |

## Production

The professional entertainment industry depends on reliable components - night in, night out. Neutrik® - the world's leading manufacturer of professional connector systems - sets the standards in technical reliability, warranty and durability. Availability of products as well as technical support and

excellent service are to be understood as priority objectives. Besides cutting-edge precision, functionality and design make the difference and build the basis for our complex demand for high quality standards.

To realize our innovative product ideas and to meet the requirements of our customers we make use of all possibilities which modern R&D and production technologies can offer. Neutrik has developed and proven its own automated manufacturing methods. The professional mechanics of the automation department work with state-of-the-art technologies like video control systems and robotics.

Together with the systematic quality control the high precision robotic production processes ensures continuous quality and efficient delivery of goods to the right place at the right time.

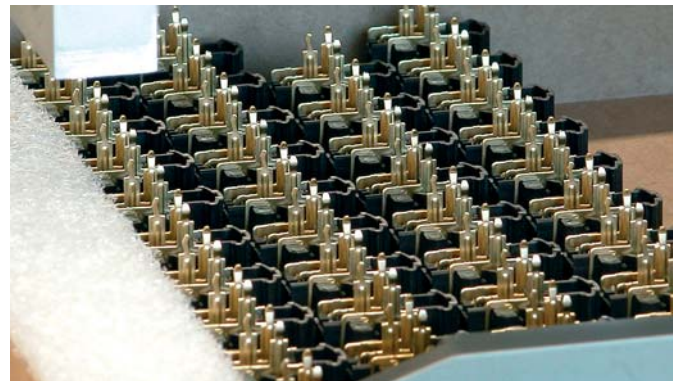
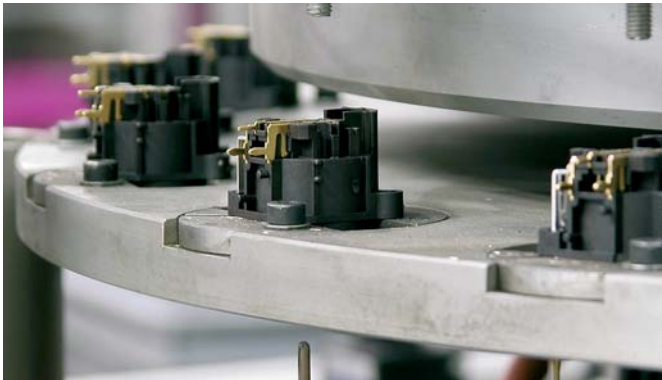



## Circular Connectors

| Content                       | Page |
|-------------------------------|------|
| PowerCon® Series .....        | 97   |
| PowerCon® 32 Amp Series ..... | 99   |
| NanoCon® Series .....         | 100  |
| MiniCon Series .....          | 102  |
| Neutricon® Series .....       | 104  |
| Technical Data .....          | 106  |
| Assembly Tools .....          | 107  |

## Introduction

The Neutrik® circular connector program is a range of metal, multi-pole connectors specifically designed for industrial applications. These series provide a variety of male and female cable connectors and receptacles that can be terminated by soldering and crimping or to printed circuit boards. An easy to use and reliable quick-lock system ensures a perfect connection and cannot be released accidentally. The circular connectors offer Neutrik® unique chuck type strain relief and reinforced housing for robust dependability.

The Neutrik® industrial connector range also features a unique power connector for single phase applications up to 32 Amps.

Further features are:

- Number of contacts is 1 to 12
- Self-locking system
- Robust all-metal housing
- Front or rear mounting
- Chuck and crimp type strain relief
- Gold plated contacts
- Solder or crimp termination
- Printed circuit board mounting
- Excellent shielding (crimp type strain relief)

The main areas of applications are in the measurement, test and control, automotive and machine tool industry as well as medical technique.







New quick lock



Neutrik hologramm

## PowerCon® - Locking 3 Pole Power Connectors

**NEW**



NAC3FCA



NAC3MPA

**NEW**



NAC3FCB



NAC3MPB

- Lockable 3 pole equipment (AC) connector with contacts for line, neutral and pre-mating safety ground
- High current capacity, rated at 20A / 250V ac.  
Colour coded for easy identification, PowerCon® offers power-in (blue) and power-out (grey) versions with different keying to avoid the possibility of intermating
- Fast and easy locking system
- Extremely robust and reliable
- Excellent cable retention
- UL, cUL recognized components (file no. E 135070)  
VDE certified (Reg. No. 6360),  
SEV approved (No. 96.1 10096)
- New latch design for easier handling and secure locking
- Branded with unique hologram - guarantees genuine and authentic Neutrik product

### NAC3FCA(B)

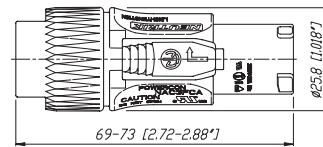

### NAC3MPA(B)

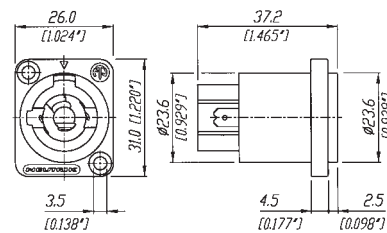

### NAC3MM

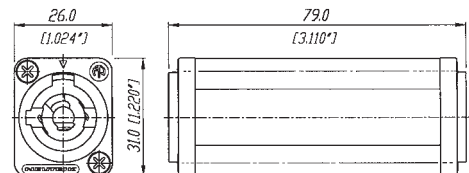

## Ordering Information

|         |   |
|---------|---|
| NAC3FCA | Cable connector, quick lock with securing lever, A-type for power inlet, screw terminals  |
| NAC3MPA | Air tight chassis connector, A-type for power inlet, flat tab terminals                   |
| NAC3FCB | Cable connector, quick lock with securing lever, B-type for power outlet, screw terminals |
| NAC3MPB | Air tight chassis connector, B-type for power outlet, flat tab terminals                  |
| NAC3MM  | Coupler for linking cables (couples NAC3FCA to NAC3FCB)                                   |

## Accessories



|          |  |
|----------|--|
| NDL      | Dummy plug for PowerCon 20 A chassis connector   |
| NLFASTON | FASTON® receptacle for tabs with "positiv lock" for use with NL4MP, NL4MPR, NL8MPR, Pack of 100 pcs. |
| SCL      | Plastic sealing cover to protect the connectors against dust and moisture                            |
| SCDR     | Rear end protection cover for D-size chassis connectors  |
| SCDX     | Hinged cover seals D-size chassis connectors, IP42 rated   |

## Accessories

With the two non-interchangeable types of connectors (A type and B type) it is impossible to produce a short circuit. Mating connectors (combination) are identified by mechanical keyways and by color.



### ATTENTION

The technical data of the PowerCon® connectors refer to connectors without breaking capacity, meaning connecting devices not to be engaged and disengaged in normal use when live or under load.



Robust metal housing



Screw-type terminals

## PowerCon® 32 Amp Connectors



NAC3FC-HC



NAC3MP-HC

- Locking single phase AC appliance coupler
- High current capacity (32 A rated)
- Fast and easy locking system
- Excellent cable handling and protection
- Extremely robust and reliable
- 250 V ac, 32 Amp single-phase (for ambient temperatures up to 35°C)
- Premating contact for protective earth
- Locking system to prevent unintentional disengagement
- Cable O.D. Range: 8 - 20 mm
- Wiring with screw-type terminals for wires 2.5 to 6.0 mm<sup>2</sup> (AWG 14 - 10)

### NAC3FC-HC

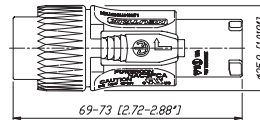

### NAC3MP-HC





Connector locking



PCB receptacle

## NanoCon® - 3 Pole Subminiature Connectors



NP3F-H



NSC3F



NR3M-S

- World's smallest circular lockable multipole connector
- Robust metal housing with gold plated contacts
- Male and female receptacles for vertical or horizontal PCB mount or solder termination
- Cable connector and receptacle with interchangeable male and female inserts
- Reliable and versatile in applications like medical equipment, control systems, sensors or audio applications such as miniature and wireless microphones and portable mixers
- Pre-mating contact 1

NSC3F(M)

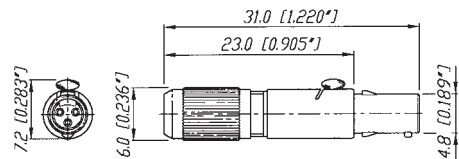

NR3F(M)-S



NP3F(M)-H

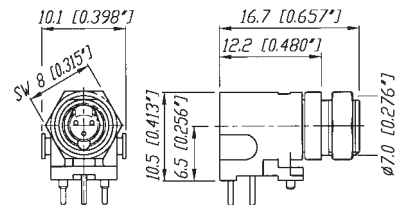

M 1:1



## Ordering Information

| Female |   | Male   |   |
|--------|---|--------|---|
| NSC3F  | Cable connector, chuck principle, solder contacts | NSC3M  | Cable connector, chuck principle, solder contacts |
| NR3F-S | Receptacle panel mount, solder contacts           | NR3M-S | Receptacle panel mount, solder contacts           |
| NP3F-H | Receptacle horizontal PCB mount                   | NP3M-H | Receptacle horizontal PCB mount                   |
| NP3F-V | Receptacle vertical PCB mount                     | NP3M-V | Receptacle vertical PCB mount                     |



NP3F-H  
NP3M-H

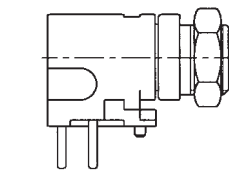

NR3F-S

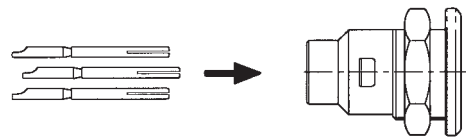

NP3F-V  
NP3M-V

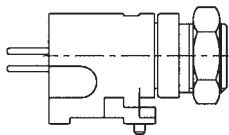

NR3M-S



### Contact Arrangement





Push Pull locking



Gold solder contacts

## MiniCon - 12 Pole Miniature Connectors



MSCM12



MRF12



MMC\* (modular system)

- Up to 12 pole miniature connector
- Complete set or modular system
- Push-pull self-locking system
- Precisely machined, rugged all metal design
- Fully loaded male and female receptacles for horizontal or vertical PCB mount
- Gold plated contacts, crimp or solder
- Special crimp type strain relief establishes an ideal coaxial connection of the cable shield to the connector shell for best EMC shielding

### MPF(M)12-V

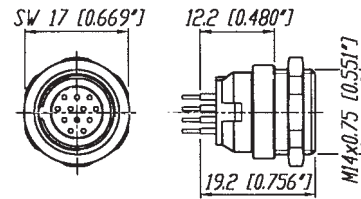

### MRF(M)12

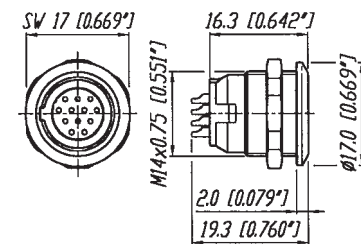

### MSCF(M)12 (+MSRC)

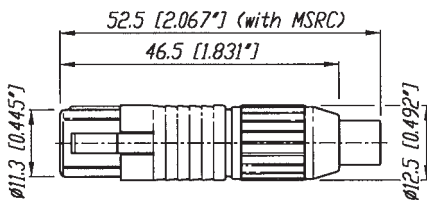

### MPF(M)12-H

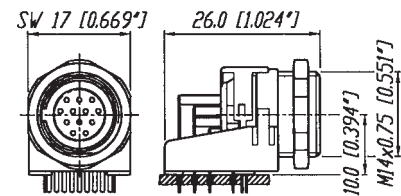

## Ordering Information for complete MiniCon set

Complete set (consisting of housing, insert, 12 contacts and chuck for cable connector)

| Female  |   | Male    |   |
|---------|---|---------|---|
| MSCF12  | Cable connector, chuck principle, solder contacts | MSCM12  | Cable connector, chuck principle, solder contacts |
| MRF12   | Receptacle panel mount, solder contacts           | MRM12   | Receptacle panel mount, solder contacts           |
| MPF12-H | Receptacle horizontal PCB mount                   | MPM12-H | Receptacle horizontal PCB mount                   |
| MPF12-V | Receptacle vertical PCB mount                     | MPM12-V | Receptacle vertical PCB mount                     |

MSCF(M)12



MPF(M)12-V

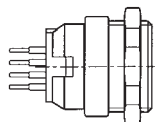

MPF(M)12-H



## Ordering Information for modular MiniCon system



### Modular system

| Female |  | Male |  |
|--------|--|------|--|
| MFI    | Insert for cable connector   | MMI  | Insert for cable connector                         |
| MBC    | Crimp contacts for cable connector and receptacle  | MPC  | Crimp contacts for cable connector and receptacle  |
| MBS    | Solder contacts for cable connector and receptacle   | MPS  | Solder contacts for cable connector and receptacle |
| MRF    | Receptacle housing and insert pre-assembled  | MRM  | Receptacle housing and insert pre-assembled        |
| MMC    | Cable connector extension, incl. chuck (for male and female)                                     |      |  |
| MSC    | Cable connector housing, incl. chuck (for male and female)                                       |      |  |
| MSRC   | Set of strain relief crimp version (tools see page 107, crimp ferrule & reduction ferrule 1 + 2) |      |  |



Push Pull locking



All metal housing

## Neutricon® - Versatile Circular Connectors



ORP8F-Ni



OSC8F



ORP8M

- Complete set or modular system for any desirable configuration
- Contact configuration can be selected from 1 to 8 contacts
- Special crimp type strain relief establishes an ideal circumferential connection of the cable shield to the connector shell as required by best EMC working practice
- Precise and robust all metal housing absorbs vibration forces and protects contact inserts
- Easy, fast and screwless assembly
- Push-pull self-locking system

### OSC8F / OSC8M

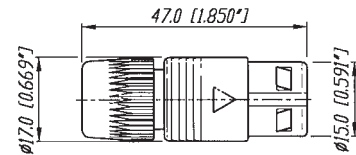

### MODULAR SYSTEM

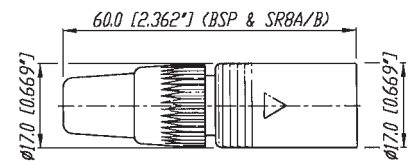

MC8 + SR8A/B + insert

### Polarization

**Housing:** Two variants of metal polarizing guides (90° and 180°).

Coding 90°



Coding 180°



**Insert:** The male and female insert can be assembled in all three housings.

### ORP8F / ORP8M

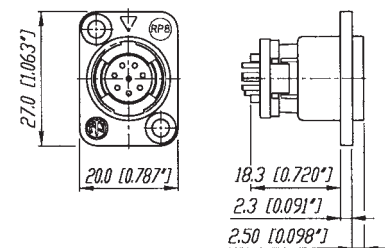



## Ordering Information for complete Neutricon set

Complete set (consisting of housing, insert, 8 contacts and chuck for cable connector)

|          |  |
|----------|--|
| OSC8F    | Female cable connector, chuck principle, black housing, solder contacts  |
| OSC8F-Ni | Female cable connector, chuck principle, nickel housing, solder contacts |
| OSC8M    | Male cable connector, chuck principle, black housing, solder contacts    |
| OSC8M-Ni | Male cable connector, chuck principle, nickel housing, solder contacts   |
| ORP8F    | Female panel mount receptacle, black housing, solder contacts            |
| ORP8F-Ni | Female panel mount receptacle, nickel housing, solder contacts           |
| ORP8M    | Male panel mount receptacle, black housing, solder contacts              |
| ORP8M-Ni | Male panel mount receptacle, nickel housing, solder contacts             |

## Ordering Information for modular Neutricon system

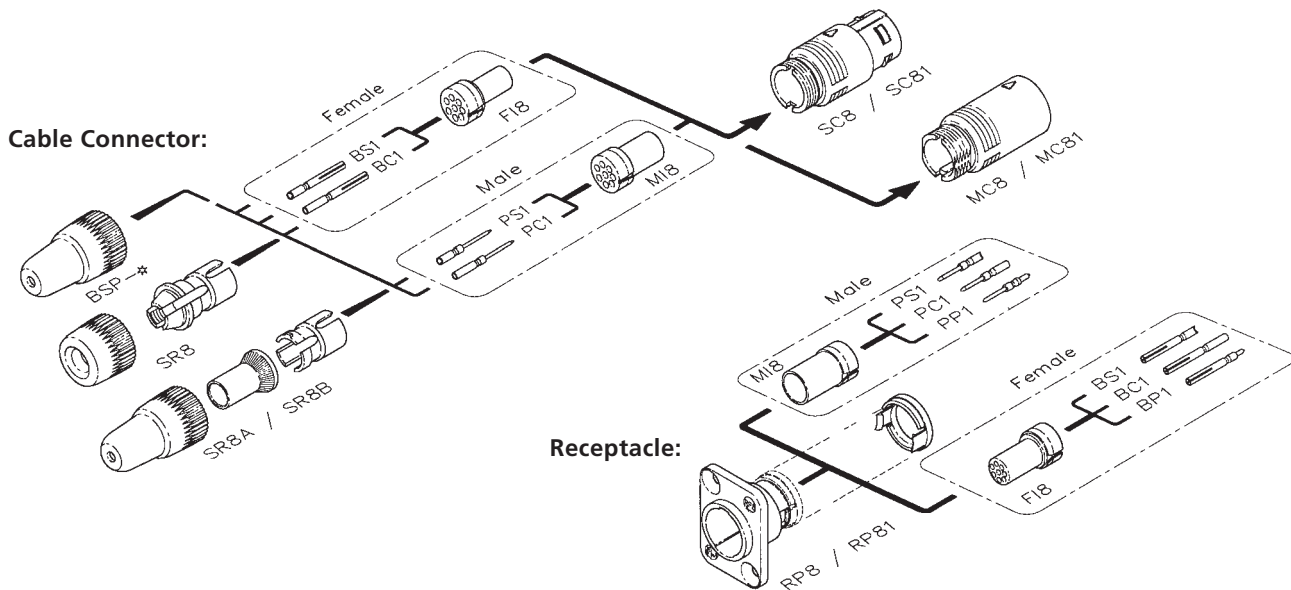

### Modular system

| Female  |   | Male    |  |
|---------|---|---------|--|
| FI8     | Insert for cable connector and receptacle   | MI8     | Insert for cable connector and receptacle        |
| BS1     | Solder contact  | PS1     | Solder contact                                   |
| BC1     | Crimp contact   | PC1     | Crimp contact                                    |
| BP1     | PCB contact   | PP1     | PCB contact                                      |
| SC8     | Cable housing, black coated, 180° coding  | MC8     | Mating cable housing, black coated, 180° coding  |
| SC8-Ni  | Cable housing, nickel coated, 180° coding   | MC8-Ni  | Mating cable housing, nickel coated, 180° coding |
| SC81    | Cable housing, black coated, 90° coding   | MC81    | Mating cable housing, black coated, 90° coding   |
| SC81-Ni | Cable housing, nickel coated, 90° coding  | MC81-Ni | Mating cable housing, nickel coated, 90° coding  |
| SC8W    | Cable housing, black coated, 180° coding, waterproof multipin connector according IP54                |         |  |
| RP8     | Receptacle, black coated, 180° coding   |         |  |
| RP8-Ni  | Receptacle, nickel coated, 180° coding  |         |  |
| RP81    | Receptacle, black coated, 90° coding  |         |  |
| RP81-Ni | Receptacle, nickel coated, 90° coding   |         |  |
| SR8     | Bushing and chuck type strain relief (standard)   |         |  |
| SR8A    | Crimp type strain relief for cable O.D. 3 - 3.8 mm (Hex crimp 5.41 mm acc. IEC 803, see also page 15) |         |  |
| SR8B    | Crimp type strain relief for cable O.D. 6 - 7 mm (Hex crimp 7.01 mm acc. IEC 803, see also page 15)   |         |  |
| SR8W    | Bushing and chuck type strain relief for waterproof solution IP54                                     |         |  |
| BSP-*   | Coloured boot, available in 10 resistor colours   |         |  |

\* color coding: 0 - Black, 1 - Brown, 2 - Red, 3 - Orange, 4 - Yellow, 5 - Green, 6 - Blue, 7 - Violet, 8 - Grey, 9 - White

| Specification | PowerCon® Series | 32 A PowerCon® Series | NanoCon® Series | MiniCon® Series | NeutriCon® Series |
|---------------|------------------|-----------------------|-----------------|-----------------|-------------------|
|---------------|------------------|-----------------------|-----------------|-----------------|-------------------|

## Electrical

|   |           |           |           |                          |                             |
|---|-----------|-----------|-----------|--------------------------|-----------------------------|
| Number of contacts:                                       | 2 + PE    | 2 + PE    | 3         | 12 (1-12 modular system) | 8 (1-8 modular system)      |
| Rated current per contact:                                | 20 A rms  | 32 A rms  | 2 A       | 3 A                      | 7.5 A (solder), 5 A (crimp) |
| Rated voltage:  | 250 V ac  | 250 V ac  | 50 V ac   | 50 V ac                  | 50 V ac                     |
| Dielectric strength:                                      | 4000 V dc | 4000 V dc | 1000 V dc | 1000 V dc                | 1500 Vdc                    |
| Contact resistance:                                       | ≤ 3 mΩ    | ≤ 3 mΩ    | ≤ 12 mΩ   | ≤ 8 mΩ                   | ≤ 5 mΩ                      |
| Insulation resistance after damp heat test (IEC 68-2-30): | > 100 MΩ  | > 100 MΩ  | > 1 GΩ    | > 500 MΩ                 | > 500 MΩ                    |

## Mechanical

|  |  |   |  |  |  |
|--|--|---|--|--|--|
| Retention method:                        | Quick lock   | Quick lock  | latch  | Push-pull  | Push-pull  |
| Cable O.D. range:                        | 5 - 15 mm  | 8 - 20 mm   | 3.4 mm max.                                      | 3 - 5 mm (grey chuck)<br>5 - 7 mm (white chuck)<br>2.5 - 6 mm (crimp version MSRC) | 3 - 7 mm<br>3 - 3.8 mm (SR8A)<br>6 - 7 mm (SR8B)     |
| Wiring:                                  | Cable: screw type terminals or soldering<br>2.5 mm <sup>2</sup> / 14 AWG | screw type terminals<br>2.5-6 mm <sup>2</sup> / 14-10 AWG | 0.2 mm <sup>2</sup> / 24 AWG for solid wire      | 0.5 mm <sup>2</sup> / 20 AWG for solder  | 1.0 mm <sup>2</sup> / 18 AWG for solder              |
|  | Chassis: flat tabs for FASTON®   |   | 0.14 mm <sup>2</sup><br>26 AWG for stranded wire | 0.22 mm <sup>2</sup><br>24 AWG for crimp   | 0.14 - 0.34 mm <sup>2</sup><br>22 - 26 AWG for crimp |
| Solderability complies with IEC 68-2-20: | •  | •   | •  | •  | •  |

## Material

|                          |                        |                     |             |  |   |
|--------------------------|------------------------|---------------------|-------------|--|---|
| Housing cable connector: | PA 6 30% GR            | PA 6 30% GR         | CuSn4Pb4Zn4 | ZnAl4Cu1 / CuZn39Pb3                             | ZnAl4Cu1<br>gal Ni or black chrome      |
| Housing receptacle:      | PA 6 30% GR            | PA 6.6 25% GR       | CuZn39Pb2   | ZnAl4Cu1   | ZnAl4Cu1,<br>gal Ni or black chrome     |
| Insert:                  | PA 6 30% GR            | PA 6.6 25% GR       | PETP        | PA 6.6   | PBTP 15% GR                             |
| Contacts:                | CuZn39Pb3 / CuSn6      | CuZn39Pb3 / CuSn0.2 | CuZn35Pb2   | CuZn35Pb2 (solder)<br>CuZn39Pb3 (crimp)<br>CuSn6 | CuZn35Pb2 (solder)<br>CuZn39Pb3 (crimp) |
| Contact surface:         | 4 μm / 20 μm Ag plated | 4 μm Ag             | 0.5 μm Au   | 0.2 μm AuCo                                      | 0.3 μm Au hard alloy over 2 μm Ni       |
| Chuck POM:               | •                      | •                   | •           | •  | •                                       |

## Environmental

|                                   |       |                                |           |           |      |
|-----------------------------------|-------|--------------------------------|-----------|-----------|------|
| Flammability UL 94 HB:            | •     | • plug housing                 | UL 94 V-0 | UL 94 V-0 | •    |
| Flammability UL 94 V-0:           | -     | • socket housing + plug insert | -         | -         | -    |
| Temperature range: -30°C to +80°C | •     | •                              | •         | •         | •    |
| Protection class (mated):         | IP 20 | IP 2X unmated                  | IP 40     | IP 5X     | IP5X |
| Safety Requirements EN/IC61984:   | •     | •                              | -         | -         | -    |

FASTON® is a trademark of AMP Inc.

## Crimptool

### Crimptool HX-CONTACT



DMC crimping tool AFM8  
acc. M22520/2-01



### MPOS-\*



Modified DMC positioner (K155)  
Contact positioner holds contact in  
position when crimping.

## Contact and connector assembly

### Crimptool HX-R-BNC



Neutrik® HEX crimping tool



### DIE-R-BNC-\*



Neutrik® DIE's for various HEX sizes.

## Neutricon® - Ordering Information Assembly Tools

|      |                      | Cable O.D. / Wire | Crimptool  | Die/Positioner | HEX-Size/Standard   |
|------|----------------------|-------------------|------------|----------------|---------------------|
| SR8A | Strain relief        | 3 - 3.8 mm        | HX-R-BNC   | DIE-R-BNC-PJ   | 5.41 mm / IEC 803   |
| SR8B | Strain relief        | 6 - 7 mm          | HX-R-BNC   | DIE-R-BNC-PS   | 7.01 mm / IEC 803   |
| BC1  | Female crimp contact | AWG 22 -26        | HX-CONTACT | MPOS-BC1       | No. 5 / M22520/2-01 |
| PC1  | Male crimp contact   | AWG 22 -26        | HX-CONTACT | MPOS-PC1       | No. 5 / M22520/2-01 |

## MiniCon® - Ordering Information Assembly Tools

|      |                                     | Cable O.D. / Wire           | Crimptool  | Die/Positioner | HEX-Size/Standard   |
|------|-------------------------------------|-----------------------------|------------|----------------|---------------------|
| MSRC | Crimp ferrule only                  | 4.5 - 6 mm                  | HX-R-BNC   | DIE-R-BNC-PDC* | 6.47 mm / IEC 803   |
| MSRC | Crimp ferrule & reduction ferrule 1 | 3.3 - 4.4 mm                | HX-R-BNC   | DIE-R-BNC-PDC* | 6.47 mm / IEC 803   |
| MSRC | Crimp ferrule & reduction ferrule 2 | 2.5 - 3.2 mm                | HX-R-BNC   | DIE-R-BNC-PDC* | 6.47 mm / IEC 803   |
| MBC  | Female crimp contact                | 24 AWG/0.22 mm <sup>2</sup> | HX-CONTACT | MPOS-MBC       | No. 5 / M22520/2-01 |
| MPC  | Male crimp contact                  | 24 AWG/0.22 mm <sup>2</sup> | HX-CONTACT | MPOS-MPC       | No. 5 / M22520/2-01 |

\* DIE-R-BNC-PJ or PS also possible





## Accessories

| Content  | Page |
|--|------|
| Circular Adapters .....                                | 111  |
| D Shape Adapters .....                                 | 112  |
| Ordering Information .....                             | 113  |
| AES / EBU Digital Impedance Transformer Adapters ..... | 114  |
| DMX Adapters .....                                     | 115  |
| Feedthrough .....                                      | 115  |
| Modules & Audio Transformers .....                     | 116  |
| Ordering Information .....                             | 117  |
| Goosenecks .....                                       | 118  |

## NEUTRIK® ACCESSORIES

Various connector standards in the professional and semi-professional audio and video world lead constantly to interconnection problems.

Neutrik® made it as a rule to serve the customers' needs in all connector belongings and offers therefore a variety of problem solvers.

With our adapter series we have a solution for the most known interconnection difficulties and on top of this we offer modules of the most common connector types to fulfil specific needs beyond that.

Miniature balancing adapters are the answer to known noise and grounding problems and for customized designs we recommend our proven audio transformers in combination with our modules.

All our adapters and connectors are soldered with lead free ROHS compliant solder.

Neutrik® is proud of being ROHS compliant with all our products and on top of this we became „Sony Green Partner“ already in the year 2003.

# Adapter



XLR connector



RCA phono socket



Jack with locking latch



BNC socket

## Circular Adapters



NA2FP



NA2MPMM



NA3MJ



NA4FC-F

- Versatile, pre-wired and ready to use adapters to reliably interlock various connector systems
- Professional look and compact space saving design, based on the X Series (XLR worldwide accepted standard)
- Rugged diecast shell for best reliability

NA3FP



NA3FM

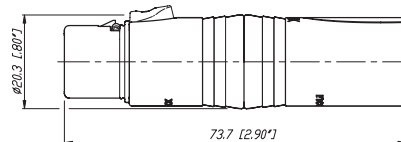

NA3FJ



NA2FBNC

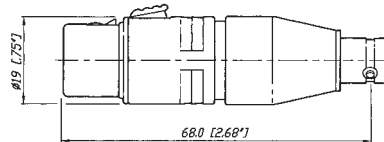

Example drawing. Find more info on [www.neutrik.com](http://www.neutrik.com)

# Adapter



Phono socket



Speakon NL4MP



3 pole XLR male



Jack with locking latch

## D Shape Adapters



NA2BBNC-D9B



NA2M-D2B-TX



NA4MP-J



NA4MP-MX

- Problem solvers for various intermating problems for professional and semi-professional applications
- Rugged aluminium extrusion housings for best reliability
- Colour coding on all RCA types

### Miniature transformer balancing adapters NA2\*-TX

- Audio Transformer 1:1 impedance ratio 200 : 200
- Low cost solution for unbalanced / balanced line conversion and passive DI applications, where no earth or gain switching is required.
- Source / Load impedance 600 / 10K  
Max. input level @ 50Hz at 1% THD: -3dBu



NA2F-D0B-TX

NA2BBNC-D9B



NA4MP-J



Example drawing. Find more info on [www.neutrik.com](http://www.neutrik.com)



## Circular Adapters

| Part No.  | Port 1            | Port 2                        | Comments                                       |
|-----------|-------------------|-------------------------------|--|
| NA2FBNC   | 3 pole XLR female | BNC socket                    | 1)   |
| NA2FP     | 3 pole XLR female | TS <sup>2)</sup> , 1/4" plug  | 1)   |
| NA2FPMF   | 3 pole XLR female | RCA / phono socket            | 1)   |
| NA2FPMM   | 3 pole XLR female | RCA / phono plug              | 1)   |
| NA2MBNC   | 3 pole XLR male   | BNC socket                    | 1)   |
| NA2MP     | 3 pole XLR male   | TS <sup>2)</sup> , 1/4" plug  | 1)   |
| NA2MPMF   | 3 pole XLR male   | RCA / phono socket            | 1)   |
| NA2MPMM   | 3 pole XLR male   | RCA / phono plug              | 1)   |
| NA3FF     | 3 pole XLR female | 3 pole XLR female             | gender conversion adapter                      |
| NA3FF-B   | 3 pole XLR female | 3 pole XLR female             | gender conversion, black plating               |
| NA3FJ     | 3 pole XLR female | TRS <sup>2)</sup> , 1/4" jack | locking jack                                   |
| NA3FM     | 3 pole XLR female | 3 pole XLR male               | extension adapter                              |
| NA3FMX    | 3 pole XLR female | 3 pole XLR male               | contacts 2 - 3 inverted                        |
| NA3FP     | 3 pole XLR female | TRS <sup>2)</sup> , 1/4" plug |  |
| NA3JJ     | stereo 1/4" jack  | TRS <sup>2)</sup> , 1/4" jack | extension adapter, locking jack                |
| NA3MJ     | 3 pole XLR male   | TRS <sup>2)</sup> , 1/4" jack | locking jack                                   |
| NA3MM     | 3 pole XLR male   | 3 pole XLR male               | gender conversion adapter                      |
| NA3MM-B   | 3 pole XLR male   | 3 pole XLR male               | gender conversion, black plating               |
| NA3MP     | 3 pole XLR male   | TRS <sup>2)</sup> , 1/4" plug |  |
| NA4FC-F   | Speakon® NL4FC    | 3 pole XLR female             | speaker adapter <sup>3)</sup>                  |
| NA4FC-M   | Speakon® NL4FC    | 3 pole XLR male               | speaker adapter <sup>3)</sup>                  |
| NA4LJX    | Speakon® NL4FX    | TS <sup>2)</sup> , 1/4" jack  | speaker adapter <sup>3)</sup>                  |
| NA4MP-F   | Speakon® NL4MP    | 3 pole XLR female             | speaker adapter <sup>3)</sup>                  |
| NA4MP-J   | Speakon® NL4MP    | TS <sup>2)</sup> , 1/4" jack  | speaker adapter <sup>3)</sup>                  |
| NA4MP-M   | Speakon® NL4MP    | 3 pole XLR male               | speaker adapter <sup>3)</sup>                  |
| NA4MP-M-X | Speakon® NL4MP    | Speakon® NL4MP                | speaker adapter 1+ / 1- inverted <sup>3)</sup> |
| NA5FF-B   | 5 pole XLR female | 5 pole XLR female             | gender conversion adapter, black plating       |
| NA5MM-B   | 5 pole XLR male   | 5 pole XLR male               | gender conversion adapter, black plating       |

## D Shape Adapters

|             |                   |                    |                                  |
|-------------|-------------------|--------------------|----------------------------------|
| NA2BBNC-D4B | BNC socket        | RCA / phono socket | colour coded yellow              |
| NA2BBNC-D9B | BNC socket        | RCA / phono socket | colour coded white               |
| NA2F-D0B-TX | 3 pole XLR female | RCA / phono socket | colour coded black <sup>4)</sup> |
| NA2F-D2B-TX | 3 pole XLR female | RCA / phono socket | colour coded red <sup>4)</sup>   |
| NA2F-J-TX   | 3 pole XLR female | 1/4" jack          | ground lifted <sup>4)</sup>      |
| NA2M-D0B-TX | 3 pole XLR male   | RCA / phono socket | colour coded black <sup>4)</sup> |
| NA2M-D2B-TX | 3 pole XLR male   | RCA / phono socket | colour coded red <sup>4)</sup>   |
| NA2M-J-TX   | 3 pole XLR male   | 1/4" jack          | ground lifted <sup>4)</sup>      |
| NE8FF       | EtherCon®         | EtherCon®          | RJ45 coupler                     |
| NL4MMX      | 4 pole Speakon®   | 4 pole Speakon®    | lockable coupler                 |
| NL8MM       | 8 pole Speakon®   | 8 pole Speakon®    | lockable coupler                 |

1) ... Wired according to IEC 268-12: pin 2 = signal, pin 1 and 3: connected to ground

2) ... TRS-Tip, Ring, Sleeve contact (stereo); TS-Tip, Sleeve contact (mono)

3) ... Detailed wiring info on [www.neutrik.com](http://www.neutrik.com)

4) ... Unbalanced / balanced line conversion, 1:1 transformer 200 Ω : 200 Ω

# Adapter



3 pole XLR female receptacle



3 pole cable connector



BNC chassis

## AES / EBU Digital Impedance Transformer Adapters



NADITBNC-F



NADITBNC-FX



NADITBNC-MX

- Allow long cable runs for digital audio signals via low attenuation coax lines
- Match balanced to coaxial lines
- Match impedances 110 Ω to 75 Ω
- Simple use, passive units

NADITBNC-FX



### Technical Data

|                               |                              |
|-------------------------------|------------------------------|
| Maximum voltage / Max. power: | 5 Vp-p / 250mW               |
| Frequency band:               | 0.1 MHz to 6 MHz             |
| Insertion loss:               | < 0.3 dB @ 0.1 MHz to 10 MHz |
| VSWR / Return loss:           | < 1.1 / > 26.4 dB            |



NADITBNC-F



NADITBNC-M

### Ordering Information

| Part No.    | Port 1                       | Port 2             | Comments                            |
|-------------|------------------------------|--------------------|-------------------------------------|
|             | Input                        | Output             |                                     |
| NADITBNC-F  | 3 pole XLR female chassis    | female BNC chassis | 110 Ω XLR input and 75 Ω BNC output |
| NADITBNC-M  | 3 pole XLR male chassis      | female BNC chassis | 75 Ω BNC input and 110 Ω XLR output |
| NADITBNC-FX | 3 pole XLR female cable con. | female BNC chassis | 110 Ω XLR input and 75 Ω BNC output |
| NADITBNC-MX | 3 pole XLR male cable con.   | female BNC chassis | 75 Ω BNC input and 110 Ω XLR output |

# Adapter



5 pole male connector



5 pole female connector



All metal housing

## DMX Adapters

## Feedthrough



NA3F5M



NA3F5M

**NEW**



NA3FDM



NA3MDF

- Compact XLR 3 to 5 pole adapters for lighting (DMX) applications
- Solve interconnection problems of the old (3-pole) and new (5-pole) DMX standard
- Enable usage of standard 3-pole microphone cable for DMX applications
- Based on the worldwide accepted standard XLR connectors
- Reliable and rugged diecast shell

- 3-pole XLR feedthrough adapter
- D-flange chassis mount
- Male to female and vice versa
- Utilizes XX-components



NA3F5M

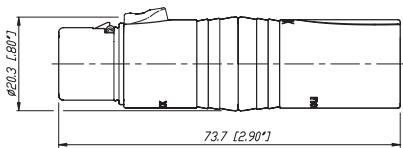

NA3MDF

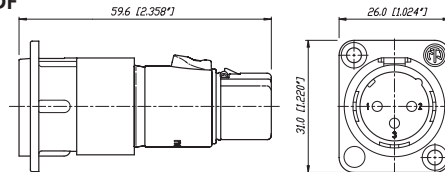

NA3FDM

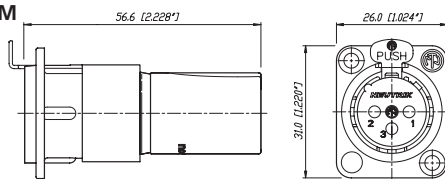

## Ordering Information DMX Adapter

| Part No. | Port 1            | Port 2            | Comments                      |
|----------|-------------------|-------------------|-------------------------------|
| NA3F5M   | 3 pole XLR female | 5 pole XLR male   | for DMX lighting applications |
| NA3M5F   | 3 pole XLR male   | 5 pole XLR female | for DMX lighting applications |

## Ordering Information Feedthrough

|        |                   |                   |
|--------|-------------------|-------------------|
| NA3FDM | 3 pole XLR female | 3 pole XLR male   |
| NA3MDF | 3 pole XLR male   | 3 pole XLR female |



3 pole plug



SM2/2 switch



VM housing

## Modules & Audio Transformers



NM3FXI



NM3P



KMX



SM2/2



NM3FD-B

- Multifunctional modules allow to design customized adapters to suit specific needs
- Based on the X Series connector system
- NTE transformers and switch can be built in
- Professional look, rugged diecast shell

### Audio Transformer

- Professional audio transformers for multiple applications, as e.g. microphone or line inputs
- Very low distortion, excellent frequency response
- Cost effective cable version for free wiring
- Fully permalloy-shielded studio versions



NTE10-3



NTL1

## Audio Transformer selection Guide





| Part No. | Turns Ratio (prim : sec) | Impedance ratio | Source / load impedance in $\Omega$ | Max. Input level* @ 50 Hz, 1% THD [dBu] | Applications                           |
|----------|--------------------------|-----------------|-------------------------------------|---|--|
| NTE1     | 1 : 1                    | 200 : 200       | 200 / 2k, (600 / 10k)               | -3                                      | General purpose, splitting, XLR inline |
| NTE4     | 1 : 4                    | 200 : 3.2k      | 200 / 10 K                          | -7                                      | Mic input step-up                      |
| NTE10/3  | 1 : 3                    | 200 : 1.8k      | 200 / 10 K                          | -7                                      | General purpose mic input step-up      |
|          | 1 : 10                   | 200 : 20k       | 200 / 50 K                          | -6                                      |  |
| NTL1     | 1 : 1                    | 10k : 10k       | 600 / 10k                           | +19                                     | Line input                             |
| NTM1     | 1 : 1                    | 200 : 200       | 200 / 2k                            | +7                                      | Mic input, splitting                   |
| NTM4     | 1 : 4                    | 200 : 3.2k      | 200 / 10k                           | +9                                      | Mic input step-up                      |

\* measured with typical source / load impedances

Wiring: NTE\*... free wires, NTL / NTM\*... PCB mount, shielded; Find detailed specifications on [www.neutrik.com](http://www.neutrik.com)

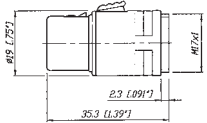

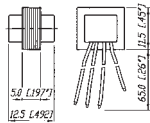
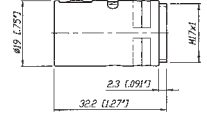
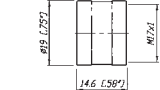
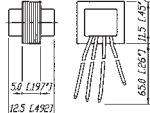
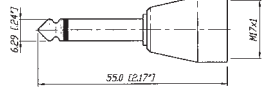
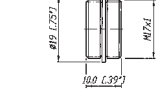
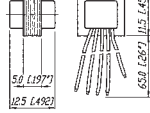
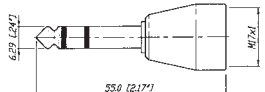
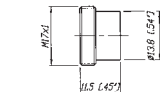
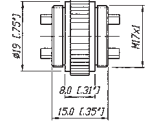
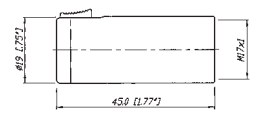
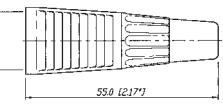
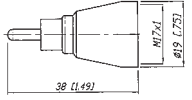
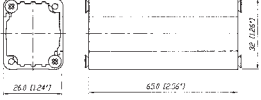
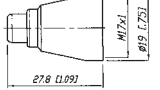
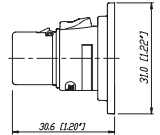
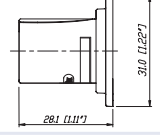
## Module Selection Guide

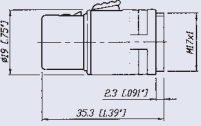
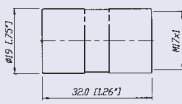
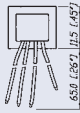
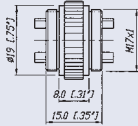
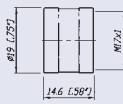
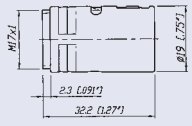
| Connector module   | Coupler / housing   | Transformer / switch  |
|--|---|---|
| NM3FXI<br>XLR female<br>M17x1 outside<br>     | KM<br>M 17x1 inside<br>  | NTE1<br>1:1<br>                          |
| NM3MXI<br>XLR male<br>M17x1 outside<br>       | KMX<br>M 17x1 inside<br>   | NTE4<br>1:4<br>                          |
| NM2P<br>mono 1/4" plug<br>M17x1 inside<br>    | VM<br>M 17x1 outside<br>   | NTE10/3<br>1:3:10<br>                    |
| NM3P<br>stereo 1/4" plug<br>M17x1 inside<br>  | VMX<br>M 17x1 outside<br>  | SM2/2<br>2x2 switch<br>M17x1 outside<br> |
| NM3J<br>stereo 1/4" jack<br>M17x1 inside<br> | CM<br>cable outlet<br>M 17x1 inside<br>                          |   |
| NMPMM<br>RCA male<br>M17x1 inside<br>       | NA-Housing <sup>1)</sup><br>black plated<br>screws included<br> |   |
| NMPMF<br>RCA female<br>M17x1 inside<br>     |   |   |
| NM3FD-B<br>black plated<br>D-Shape<br>      |   |   |
| NM3MD-B<br>black plated<br>D-Shape<br>      |   |   |
| 1) ... Combinations possible with all D Shape connectors like e.g. NC3FD-L-1, NF2D, NBB75DSI, etc.                             |   |   |
| <b>Example:</b><br>                        |   |   |
| <br>NM3FXI                                  | <br>KM   | <br>NTE1                                 |
| <br>SM2/2                                   | <br>KMX   | <br>NM3MXI                             |

# Goosenecks



3 pole XLR with securing ring



Flexible spiral



Integrated cable outlet

## Goosenecks



GN18



GN36



GN50

- For flexible and secure mounting of microphones, lamps etc.
- Versatile, modular system allows various combinations
- Durable stainless steel spiral, no rust, no noise, non-reflective black finish
- Theft proof microphone connection on GNS version (securing ring and fixing screw)

## Ordering Information

| Part No.   | Description  |
|--|--|
| GN18   | M17x1 inside thread at both ends (Ø 12 mm, 230 mm length)                                      |
| GN36   | M17x1 inside thread at both ends (Ø 13 mm, 360 mm length)                                      |
| GN50   | M17x1 inside thread at both ends (Ø 15 mm, 500 mm length)                                      |
| Gooseneck sets:  |  |
| GNS18  | Gooseneck set GN18, NC3FX-Spec., cable outlet, NAM5 adapter, M17x1 bolt thread                 |
| GNS36  | Gooseneck set GN16, NC3FX-Spec., cable outlet, NAM5 adapter, M17x1 bolt thread                 |
| GNS50  | Gooseneck set GN50, NC3FX-Spec., cable outlet, NAM5 adapter, M17x1 bolt thread                 |
| Accessories:   |  |
| NAM4   | M17x1 outside thread, 5/8" 27 UNS inside thread <sup>1)</sup>                                  |
| NAM5   | 3/8" inside thread, 5/8" 27 UNS outside thread <sup>1)</sup>                                   |
| GF1  | Panel-mounting kit: Flange Ø 63.5 mm including mounting bolt M17x1, 30 mm length <sup>1)</sup> |
| MSG  | Mounting bolt M17x1, 30 mm length <sup>1)</sup>  |
| <sup>1)</sup> ... Find detailed specifications on <a href="http://www.neutrik.com">www.neutrik.com</a> |  |

### GNS Set consisting of:

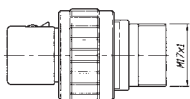

NC3FX-Spec

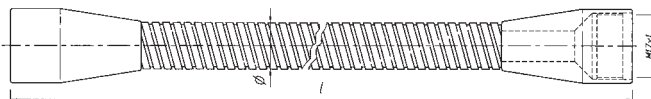

GN

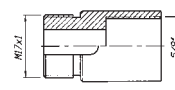

Cable outlet



NAM5

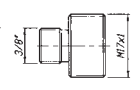

M17x1 bolt



## Patch Panels

| Content                                  | Page |
|--|------|
| NPPA-Series - 96 Bantam (TT) Jacks ..... | 121  |
| NPP-TB-Series - 48 B-Gauge Jacks .....   | 123  |
| 1/4" Patch Panel .....                   | 125  |
| MA 96 and XPM 96 Bantam Patchbays .....  | 127  |
| LF 48 B-Gauge Patchbays .....            | 129  |
| Technical Data .....                     | 131  |
| Ordering Information .....               | 132  |

## Introduction

Patch Panels are central switching gears between audio equipments. They are used to switch and route analog and digital audio signals from and to equipments in recording or broadcast studios, OB vans, churches, theatres, stadiums, arenas, etc.

Neutrik® Patch Panels are available in a variety of jack types, wiring and grounding possibilities. Common versions accommodating Bantam TT, 1/4" A-gauge and longframe B-gauge jacks on the front rows are available. The mechanical size is designed to fit into 1U 19" standard racks. All Neutrik Patch Panels offer various normalling possibilities between top and bottom row.

All Neutrik® Patch Panels are able to handle digital audio signals acc. AES3, 48kHz sampling rate.

## Audio Normalling

Audio Normalling is usually used with audio patch panels and is a wiring pattern in which a circuit path is established from one piece of audio equipment to another without the use of a patch cord. This pattern is then considered to be the „normal“ circuit path that is desired most of the time. If a patch cord is inserted, the normal circuit path is interrupted and rerouted to a different circuit path.

Normalled patch panels are most commonly found in vertical jack pairs: the top jack is designated as the source and the bottom jack is the destination.

Normalling example: HALF NORMALLED BOTTOM ROW

This is the most common configuration, very often called HALF NORMALLED. In this configuration internal normalling contacts

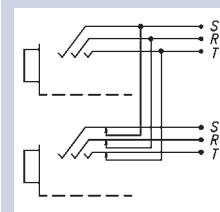

connect the top jack contact with the corresponding bottom jack contact. Inserting a plug in the bottom jack will interrupt this internal normalling connection, while inserting a patch cord into the top jack doesn't interrupt the circuit. (Can be used to monitor the normalling circuit)

Other versions of normalling are Half Normalled Top Row, Full Normalled, Parallel and Isolated.



# " Easy Patch " Patch Panel



Robust front design



Easy assembly



Jack-pair



IDC terminals



Push terminals



ELCO connectors

## NPPA-Series - 96 Bantam (TT) Jacks



NPPA-TT-PT

- Innovative and compact patching system (just 1U high) for 19" rack mounting
- Robustly housed in a black coated steel shell
- New high quality long life gold plated Neutrik® prewired double jacks with drastically improved contact integrity
- Available in all common normalling configurations (default HNB)
- Qualified for analog and digital signals acc. AES 3, 48 kHz sampling frequency
- Different choices of wiring

### Dimensional Drawing



## Design Criteria

All panels are fitted with high quality, long life Neutrik® NJ3TTA gold plated double contact jacks (2 x 48), featuring drastically improved contact integrity and are available with a wide choice of wiring terminations. The unit is finished off with a built in cable bar and two large channel ident strips for perfect management of the system.

The new generation of the Neutrik® "Easy-Patch" is easily programmable for any one of five configurations (standard is half normalised bottom row) and for the grounding system of your choice. Each individual pair of jacks can be changed

or reconfigured quickly and without fuss even while the panel is "on air". The NJ3TTA jacks offer also two contact points per terminal (TRS) with a special designed mechanism for the normalling contact. Simply remove the front panel to reveal the easy access jack. Remove, replace or reconfigure the jack and refix the panel.

The "Easy-Patch" is an innovative and compact patching system (just 1U high) for 19" rack mounting. Robustly housed in a black coated steel shell and featuring precision aluminium fittings it is built to last.

## Configuration

The standard version of the NPPA Panel is delivered bottom row half normalised for each jack pair by default. Further patch versions are available with fully loaded jack-pairs as:

- Full Normalled
- Half Normalled
- Isolated
- Parallel

For individual normalling single pre-configured jack-pairs are offered.

NPPA-TT-IDC is equipped with jumper blocks for individual switching configurations of each jack channel.

Note: Take care when handling digital signals. Do not use parallel configuration and avoid other parallel paths when using half normalised configurations. Parallel paths may lead to mismatching.

Half Normalled Bottom



Half Normalled Top



Full Normalled

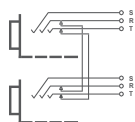

Parallel



Isolated



## Grounding

The flexible grounding system provides the following versions:

- Individual: Each channel is individually grounded by its corresponding cable shield (default configuration).
- Group: Selected channel grounds are connected via the ground bus on the PCB using solder bridges and track cuts to form a group that is connected to one common cable shield.
- Central: All channel grounds (individual top and bottom row) are connected via the ground bus on the PCB using solder bridges and wired with only one cable shield.
- Chassis-Common: The same as central grounding but with the addition of the common ground bus (top and / or bottom rows) connected to the patch panel chassis by means of jumpers

## Wiring Terminations

TT Patch Panels offer different choices of wiring:

- Spring loaded push terminals
- 56 pin Elco/Edac male connectors
- 90 pin Elco/Edac connectors
- 50 pin D-SUB connectors
- 25 pin D-SUB connectors
- IDC-Krone terminals
- Solder lugs

The spring loaded terminal blocks enable fast and easy wiring. No soldering and screwing necessary. Simply insert the stripped wire after pressing down the white key. Terminals accommodate stranded wires up to AWG 20 (0.5 mm<sup>2</sup>) and solid wires up to AWG 18 (0.75 mm<sup>2</sup>). Push terminals are gas tight connections.

For Pin assignment of ELCO / EDAC and D-SUB connectors please refer to website.

# " Easy Patch " Patch Panel



Individual colour coding



Galvanized metal housing

## NPP-TB-Series - 48 B-Gauge Jacks

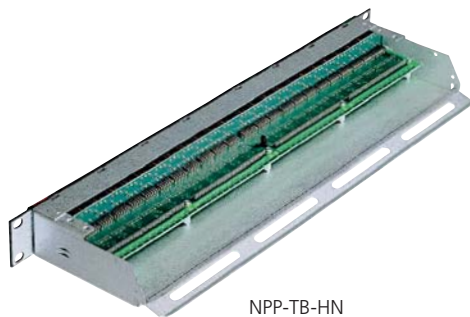

NPP-TB-HN

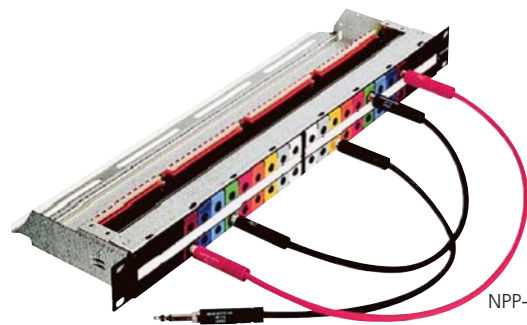

NPP-TB + NPP-LB\*

- Features 2 x 24 Neutrik® NJ6TB-V long frame 1/4" TRS jacks according to BPO 316 / MIL-P-641/3
- Very robust and compact galvanized metal housing
- Eye catching channel identification through coloured snap-on coding tabs
- Six easily programmable switching configurations
- Qualified for analog and digital signals acc. AES 3, 48 kHz sampling frequency
- With high quality long life gold plated Neutrik® jacks

### Dimensional Drawing

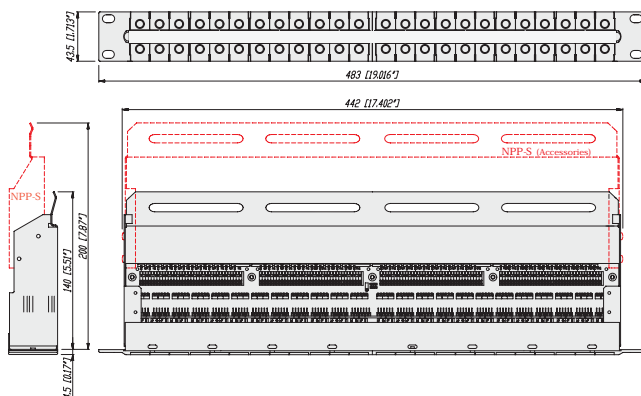

## Design Criteria

The TB Patch Panel is a very robust and compactly designed Patch Panel for 19" rack mount (19" x 1U) with galvanized metal housing, a built-in cable bar on the rear for securing wires. There is a rear extension bar (NPP-S) available as an option for some panel types. On the front side we have an attractive additional lettering facility for each channel pair with a marking strip and individual snap-on colour coding plates.

The NPP is easily programmable for six switching configurations and for changing the flexible grounding system. All panels have the high quality long life gold plated Neutrik® NJ6TB-V Jack for the BPO / MIL style plugs. We have two variants of rear connection. The standard is equipped with spring loaded terminals strips and an optional version offers solder lugs.

## Configuration

Due to the jumper blocks capability provided, the switching configurations available per jack channel are:

- Half Normalled Bottom Row
- Full Normalled
- Parallel
- Isolated

The TB Panel is delivered in a full normalled configuration for each jack channel. A non-configurable half normalled (" -HN") bottom row version with solder lugs is also available.

NOTE: Take care when handling digital signals. Do not use Parallel configuration and avoid other parallel paths with Half / Double Normalled configurations. Parallel paths may lead to mismatching.



## Grounding

The flexible grounding system allows four possibilities to fit your needs:

- Individual: Each channel ground is separately connected with the corresponding cable shield (default configuration).
- Group: Some channel grounds are PCB connected by making soldering joints on the PCB and by cutting tracks respectively to form a group that is connected to one common cable shield.
- Central: All channel grounds are PCB connected by making soldering joints and wired with only one cable shield.
- Chassis-Common: Same as central grounding with additional connection of the common ground to the Patch Panel chassis by means of a jumper.

## Wiring Terminations

TB Patch Panels are available with:

- Spring loaded push terminals (NPP-TB)
- Solder lugs (NPP-TB-HN)

The spring loaded terminal blocks are fast and easy to connect and disconnect the wires. No soldering and screwing necessary. Simply insert the stripped wire after pressing down the white key. Accommodates stranded wires up to AWG 20 (0.5 mm<sup>2</sup>) and solid wires up to AWG 18 (0.75 mm<sup>2</sup>).



Ruggedized metal housing



Imprinted grounding instruction



Module  
NYS-SPCR1

## 1/4" Patch Panel



NYS-SPP-L1

- Individual grounding available for each channel separately
- Ruggedized metal housing
- Improved contact design minimises wear on mated plugs
- Economic and versatile designed 1/4" modular Patch Panel with 2 rows of jack sockets
- 48 balanced channels with fully PCB wired jack (24 vertical PC boards), 24 front pairs and corresponding 24 rear pairs
- Jack PC card contains 4 balanced 1/4" jacks with non-tarnishing contacts, is held securely in place without the use of nuts - no little pieces to drop, break or lose
- Easy to change configuration by just flipping individual PC board
- Normalling jack is coloured grey for easy identification
- 4 designation strips included for front and rear panel

### Dimensional Drawing

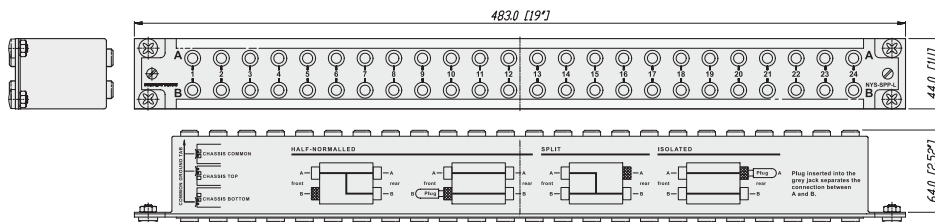

## Design Criteria

The NYS-SPP-L1 is a economical and remarkable sleek designed 1/4" modular Patch Panel for 19" rack mount (19" x 1U) with a reinforced metal housing. Each of it's 48 PCB wired balanced channels (24 front pairs and corresponding 24 rear pairs) can either be grounded separately or in groups of individually chooseable channel numbers (detailed information see below).

The PCBs are held securely in place by being clamped between the front and the rear panel, this grants an easy reconfiguration of the Patch Panel without the danger of loosing any small parts (e.g. nuts). The grey jack serves as an easy and distinguishable normalling identification.

## Configuration

Standard configuration, when delivered, is Half Normalled bottom row. The configuration can easily be changed by just flipping the individual PCB. Inserting a plug into the

grey jack will always isolate the top against the bottom row. Alternative solution for send/return applications by use of NYS-SPCR1 module (see accessories below).

The following configurations are available:



## Grounding

The flexible grounding system, applicable for each channel separately by simply attaching the loose supplied grounding clips to the grounding pad of the corresponding channel, offers the following alternatives:

- Individual (without grounding clip): Each channel ground (sleeve contact) is connected to the dedicated ground contact of the incoming 1/4" plug only. This is the standard configuration for delivery.
- Chassis common Ⓞ: The relevant channel grounds (sleeve contacts; top and bottom row) is connected to the ground flat tab via grounding clip and chassis.
- Chassis top Ⓜ: The dedicated top channel ground (sleeve contact) is connected to the ground flat tab via grounding clip and chassis.
- Chassis bottom Ⓝ: The dedicated bottom channel ground (sleeve contact) is connected to the ground flat tab via grounding clip and chassis.





Standard 4.4mm  
bantam jack



Long frame jack  
socket

## MA 96 and XPM 96 Bantam Patchbays



- Robust designed patchbay to accept standard 4.4 mm Bantam jack connectors (acc. MIL-D-642/13)
- Fitted with 96 Rean die-cast jack sockets
- Constructed from rigid aluminium extrusion which includes 2 integral slots for designation strips
- 96 channels grouped in two row 12 x 8 stereo jacks
- XPM96 features traditional 2 row, 4 x 24 stereo jacks
- Available in 4 colours: black, silver, red or blue
- Suitable for audio, broadcast, data and industrial applications XPM96

### Dimensional Drawing





Die-cast frame



Tinned tags

## MAJ 501 Bantam Jack Socket

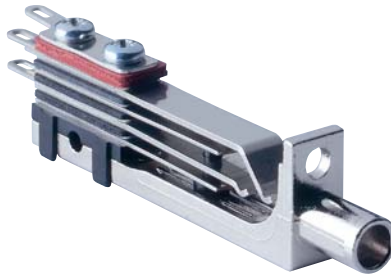

- 5-point Bantam jack socket (Tip, Ring, Sleeve, Tip Normal, Ring Normal)
- Rigid nickel plated die-cast frame, featuring considerable frame strength eliminating physical distortion when plug is inserted
- Nickel-silver spring contacts, palladium plated switch contacts
- Tinned tags for easy soldering

### Termination



### End Elevations



### Plan Elevations



### Circuit Detail

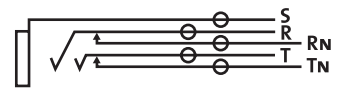





B-Gauge patchbay    48 way longframe

## LF 48 B-Gauge Patchbays



- 48 way Longframe B-Gauge patchbay
- Accepts both European BPO 316 and US MIL-P-642/2 style phono plugs
- 2 rows of 24 LF501 jack connectors
- Jack designed from rigid nickel-plated die-cast aluminium with nickel-silver spring contacts
- Available in 4 colours: black, silver, red or blue
- Reliable support for connecting looms by steel lacing bar

### Dimensional Drawing

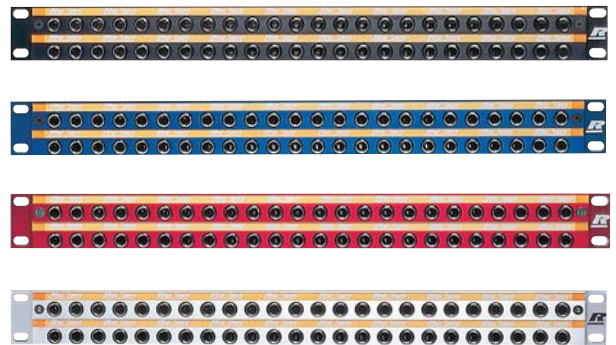



Solder lugs

## LFJ 501 B-Gauge Jack Socket



- 5-point B-Gauge jack socket
- Nickel-silver spring contacts
- Palladium plated switch contacts
- Durable die-cast body with bright nickel plated nose
- Termination solder lugs

### LFJ 501



### Plan Elevations

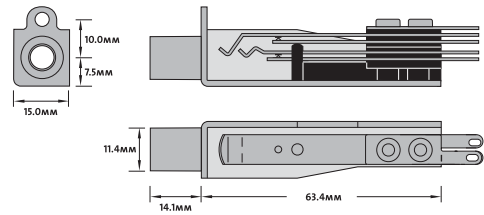

### Circuit Detail

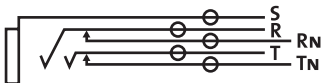

| Specifications | NPPA Series | NPP-TB Series | NYS Series | MA 96 and XPM 96 | LF 48 Series |
|----------------|-------------|---------------|------------|------------------|--------------|
|----------------|-------------|---------------|------------|------------------|--------------|

## Electrical

|                                       |                                     |         |         |         |         |
|---------------------------------------|-------------------------------------|---------|---------|---------|---------|
| Contact resistance:                   | < 20 mΩ                             | < 10 mΩ | < 10 mΩ | < 24 mΩ | < 20 mΩ |
| Switch contact resistance:            | < 25 mΩ                             | < 15 mΩ | < 10 mΩ | < 26 mΩ | < 15 mΩ |
| Insulation resistance:                | > 1 GΩ @ 500 V dc                   | ●       | ●       | ●       | ●       |
| Dielectric strength:                  | > 500 V ac                          | ●       | ●       | ●       | ●       |
|                                       | > 1'000 V dc                        | ●       | ●       | -       | -       |
| Frequency range:                      | DC to > 50 MHz                      | ●       | ●       | ●       | ●       |
| Channel separation:                   | > 100 dB @ 10 kHz, 600 Ω terminated | ●       | ●       | ●       | ●       |
|                                       | > 40 dB @ 6 MHz, 110 Ω terminated   | ●       | ●       | ●       | ●       |
| AES / EBU Signals (digital) suitable: |                                     | ●       | ●       | ●       | ●       |
| Handles Phantom Power:                |                                     | ●       | ●       | ●       | ●       |

## Mechanical

|                      |   |                                |                    |                                      |                                |                           |
|----------------------|---|--------------------------------|--------------------|--------------------------------------|--------------------------------|---------------------------|
| Life time:           | > 20'000 cycles   | -                              | -                  | -                                    | ●                              | ●                         |
|                      | > 10'000 cycles   | -                              | -                  | ●                                    | -                              | -                         |
|                      | > 5'000 cycles  | ●                              | ●                  | -                                    | -                              | -                         |
| Insertion force:     | < 25 N  | -                              | -                  | ●                                    | ●                              | -                         |
|                      | < 20 N  | -                              | ●                  | -                                    | -                              | -                         |
|                      | < 10 N  | ●                              | ●                  | -                                    | -                              | -                         |
| Withdrawal force:    | > 10 N  | ●                              | ●                  | ●                                    | ●                              | ●                         |
|                      | > 8 N   | ●                              | ●                  | -                                    | -                              | -                         |
| Dimensions:          | 482 x 44 mm (19" x 1U)                                    | ●                              | ●                  | ●                                    | ●                              | ●                         |
| Depth:               |   | 178 mm (7")                    | 140 mm (5.5")      | 64 mm (2.52")                        | 110 mm (4.33")                 | 115 mm (4.53")            |
| Dimension Patch Box: | 168 x 77 x 77 mm (6.0 x 3 x 3")                           |                                |                    |                                      |                                |                           |
| Temperature range:   | -30°C to +80°C  | ●                              | ●                  | ●                                    | ●                              | ●                         |
| Mating plug:         |   | 4.4 mm (0.173")<br>Bantam plug | B-Gauge 1/4" plug  | A-Gauge 1/4" plug<br>acc. EIA RS-453 | 4.4 mm (0.173")<br>Bantam plug | Longframe<br>B-Gauge plug |
| Groundin wiring      | according<br>flat tab for 3/16"<br>FASTON® (4.8 x 0.8 mm) | MIL-P-642/13                   | BPO316/MIL-P-642/2 | TEC60603-11                          | MIL-P-642/13                   | BPO316/MIL-P-642/2        |
|                      |   | -                              | -                  | ●                                    | -                              | -                         |

## Materials

|                  |                |               |                    |                  |                  |
|------------------|----------------|---------------|--------------------|------------------|------------------|
| Housing:         | Steel          | Steel         | Steel              | anodised Al      | anodised Al      |
| Front panel:     | anodised Al    | Pocan B 3225  | Steel              | anodised Al      | anodised Al      |
| Lacing bar:      | Brass          | Steel         | N / A              | coated steel     | coated steel     |
| Jack housing:    | PA 66 blend    | PA 6.6 30% GR | ABS                | diecast alloy    | diecast Al       |
| Jack contacts:   | CuSn6          | CuSn6         | CuSn6              | Ni-Silver        | Ni-Silver        |
|                  | Tribor® plated | Au plated     | tin plated         | (CuNi18Zn20)     | (CuNi18Zn20)     |
| Switch contacts: | Au plated      | Au plated     | Bronze, tin plated | Palladium plated | Palladium plated |
| Grounding clip:  | -              | -             | CuSn6, SnCu plated | -                | -                |

## Operating Accessories



Labeling software:

Patchlabel is a program to Label Patch Panel designation strips.

Free Download of Patch Label Program (ZIP - 347 KB) on the Web "[www.neutrik.com](http://www.neutrik.com)" section "Patch Panels".

# Ordering Information

| Part Number | Description |
|-------------|-------------|
|-------------|-------------|

| NPPA Series      |              | Configuration*          | Wiring                           | Grounding             |
|------------------|--------------|-------------------------|----------------------------------|-----------------------|
| NPPA-TT-PT**     | 2 x 48 jacks | half normalled bottom   | 288 push terminals               | individual            |
| NPPA-TT-PT-FN**  | 2 x 48 jacks | full normalled          | 288 push terminals               | individual            |
| NPPA-TT-PT-HNT** | 2 x 48 jacks | half normalled top row  | 288 push terminals               | individual            |
| NPPA-TT-PT-I**   | 2 x 48 jacks | isolated                | 288 push terminals               | individual            |
| NPPA-TT-PT-P**   | 2 x 48 jacks | parallel                | 288 push terminals               | individual            |
| NPPA-TT-S**      | 2 x 48 jacks | half normalled bottom   | 288 solder terminals             | individual            |
| NPPA-TT-S-FN**   | 2 x 48 jacks | full normalled          | 288 solder terminals             | individual            |
| NPPA-TT-S-HNT**  | 2 x 48 jacks | half normalled top row  | 288 solder terminals             | individual            |
| NPPA-TT-S-I**    | 2 x 48 jacks | isolated                | 288 solder terminals             | individual            |
| NPPA-TT-S-P**    | 2 x 48 jacks | parallel                | 288 solder terminals             | individual            |
| NPPA-TT-PT-PH    | 2 x 48 jacks | half normalled bottom   | 288 Phoenix push terminals       | individual            |
| NPPA-TT-SD50     | 2 x 48 jacks | half normalled bottom   | 4 x 50 pole D-SUB                | groups of 12 channels |
| NPPA-TT-SD25     | 2 x 25 jacks | half normalled bottom   | 10 x 25 pole D-SUB               | groups of 12 channels |
| NPPA-TT-E56      | 2 x 48 jacks | half normalled bottom   | 6 x 56 pole ELCO male connectors | individual            |
| NPPA-TT48-E56    | 2 x 24 jacks | half normalled bottom   | 3 x 56 pole ELCO male connectors | individual            |
| NPPA-TT-E90      | 2 x 48 jacks | half normalled bottom   | 4 x 90 pole ELCO male connectors | individual            |
| NPPA-TT-IDC      | 2 x 48 jacks | programmable by jumpers | 288 IDC terminals (KRONE-Type)   | individual            |

\* fully loaded jack pairs only, to built patch panels with mixed configuration use pre-config jackpairs

\*\* in case of need added normalling bars can be used to reconfigure up to 4 jackpairs

## Pre-configured Jack-Pairs

|              |                      |                           |                           |
|--------------|----------------------|---------------------------|---------------------------|
| NJ3TTA-4-HNB | blocks of 2 channels | half normalled bottom row | cover ident color: clear  |
| NJ3TTA-4-HNT | blocks of 2 channels | half normalled top row    | cover ident color: yellow |
| NJ3TTA-4-FN  | blocks of 2 channels | full normalled            | cover ident color: green  |
| NJ3TTA-4-P   | blocks of 2 channels | parallel                  | cover ident color: red    |
| NJ3TTA-4-I   | blocks of 2 channels | isolated                  | cover ident color: orange |

## Accessories

|        |                   |
|--------|-------------------|
| NPPA-S | Strain Relief bar |
|--------|-------------------|

## NPP-TB Series

|           | Configuration                        | Wiring  |
|-----------|--------------------------------------|---|
| NPP-TB    | 2 x 24 TB (BP0316/MIL-P-642/2) jacks | programmable for all commonly used configurations |
| NPP-TB-HN | 2 x 24 TB (BP0316/MIL-P-642/2) jacks | half Normalled Bottom Row                         |

## Accessories

|           |   |
|-----------|---|
| NPP-LB-** | Channel identification and status plates, pack of 100 per color, 9 different colors |
| NPP-C     | Metal dust cover  |
| NPP-S     | A second rear extention bar for fix the very large cables.                          |
| NKTB*     | Patch cord with NP3TB plugs. Available in black and red. Length: 30, 40, 60, 90 cm  |

\*\* : 0 - Black, 1 - Brown, 2 - Red, 3 - Orange, 4 - Yellow, 5 - Green, 6 - Blue, 7 - Violet, 8 - Grey, 9 - White; Must be ordered in multiples of 100.

## NYS SPPL

|            |  |
|------------|--|
| NYS-SPP-L1 | 1/4" Patch Panel, 2 x 24 channels, configuration half normalled, isolated, split |
| NYS-SPCR1  | Send / Return module (Split Print)   |



| Part Number | Description |
|-------------|-------------|
|-------------|-------------|

## Re'an Bantam Patchbays

|          |   |
|----------|---|
| MA96-1A  | 96 way, Red front panel - grouped 12 x 8    |
| MA96-1D  | 96 way, Blue front panel - grouped 12 x 8   |
| MA96-1O  | 96 way, Black front panel - grouped 12 x 8  |
| MA96-1S  | 96 way, Silver front panel - grouped 12 x 8 |
| XPM-96SS | 96 way, Silver front panel - grouped 4 x 24 |
| XPM-96SO | 96 way, Black front panel - grouped 4 x 24  |

## Bantam Jack Socket

|         |                     |
|---------|---------------------|
| MAJ-501 | Standard Solder Tag |
|---------|---------------------|

## Re'an Longframe B-Gauge Patchbays

|         |  |
|---------|--|
| LF48-1A | 48 way, Red front panel                            |
| LF48-1D | 48 way, Blue front panel                           |
| LF48-1O | 48 way, Black front panel                          |
| LF48-1S | 48 way, Silver front panel                         |
| LFJ-501 | Longframe B-Gauge jack socket, standard solder tag |





**Liechtenstein (Headquarters)**

NEUTRIK AG  
Im alten Riet 143  
9494 Schaan  
T +423 237 24 24  
F +423 232 53 93  
neutrik@neutrik.com

**Great Britain**

Neutrik (UK) Ltd.  
Westridge Business Park  
Cothey Way  
Ryde, Isle of Wight PO33 1QT  
T +44/1983/811 441  
sales@neutrik.co.uk

**Japan**

Neutrik Limited  
Yusen-Higashinonbashi-  
Ekimae Bldg., 3-7-19  
Higashinonbashi, Chuo-ku  
Tokyo 103  
T +81/3/3663 47 33  
mail@neutrik.co.jp

**Switzerland**

Neutrik Zürich AG  
Steinackerstrasse 35  
8902 Urdorf  
T +41/44/736 50 10  
neutrik@neutrik.ch

**Germany/Netherlands/  
Austria**

Neutrik Vertriebs GmbH  
Felix-Wankel-Strasse 1  
85221 Dachau  
T +49/8131/28 08 90  
info@neutrik.de

**USA**

Neutrik USA Inc.  
195 Lehigh Avenue  
Lakewood, NJ 08701-4527  
T +1/732/901 94 88  
info@neutrikusa.com

**France**

Neutrik France SARL  
Rue du Parchamp, 13  
92100 Boulogne-Billancourt  
T +33/1/41 31 67 50  
info@neutrik-france.com

**Hong Kong**

Neutrik Hong Kong LTD.  
Workshop 14, 16 Floor, Wah  
Wai Centre  
Nr. 38-40 Au Pui Wan Street  
Shatin, New Territories  
T +852 2687 6055  
neutrik@neutrik.com.hk