

Connector - SACC-M12FS-4CON-PG7-M - 1681127

Please be informed that the data shown in this PDF Document is generated from our Online Catalog. Please find the complete data in the user's documentation. Our General Terms of Use for Downloads are valid (<http://download.phoenixcontact.com>)



Sensor/actuator connector, female, straight, 4-pos., M12, A-coded, screw connection, metal knurl, cable screw connection Pg7

Product Features

- Safe use in the field, thanks to a high degree of protection
- Flexible: connectors for on-site assembly
- Screw connection: proven connection technology for a large selection of different conductors

Key commercial data

package_quantity	1
GTIN	4017918157456

Technical data

Dimensions

External diameter	4 mm ... 6 mm
--------------------------	---------------

Ambient conditions

Ambient temperature (operation)	-40 °C ... 85 °C (Plug / socket)
Degree of protection	IP67

General

Rated current at 40°C	4 A
Rated voltage	250 V
Number of positions	4
Contact resistance	≤ 8 mΩ
Insulation resistance	≥ 100 MΩ
Coding	A - standard
Standards/regulations	M12 connector IEC 61076-2-101
Status display	No
Surge voltage category	II
Pollution degree	3
Connection method	Screw connection
Conductor cross section	0.25 mm ² ... 0.75 mm ²
AWG conductor cross section	24 ... 18
Insertion/withdrawal cycles	≥ 100
Torque	0.4 Nm (M12 knurl)

Connector - SACC-M12FS-4CON-PG7-M - 1681127

Technical data

General

Torque	0.2 Nm (Screw terminal blocks)
Torque	0.8 Nm ... 1 Nm (Pressure screw)
Tightening torque	Screw plug insert with sleeve housing as far it will go
Assembly instructions	The wires can be connected both with ferrules and without ferrules

Material

Inflammability class according to UL 94	HB
Contact material	CuZn
Contact surface material	CuSnZn
Contact carrier material	PA 66
Material of grip body	PBT
Material, knurls	Zinc die-cast, nickel-plated
Sealing material	NBR

classifications

eCl@ss

eCl@ss 4.0	27140815
eCl@ss 4.1	27140815
eCl@ss 5.0	27260701
eCl@ss 5.1	27260701
eCl@ss 6.0	27279221
eCl@ss 7.0	27440104
eCl@ss 8.0	27440104

ETIM

ETIM 2.0	EC001121
ETIM 3.0	EC002062
ETIM 4.0	EC002062
ETIM 5.0	EC002062

UNSPSC

UNSPSC 6.01	31251501
UNSPSC 7.0901	31251501
UNSPSC 11	31251501
UNSPSC 12.01	31251501
UNSPSC 13.2	31251501

approvals

UL Recognized / cUL Recognized / GOST / cULus Recognized /

Approval details

Connector - SACC-M12FS-4CON-PG7-M - 1681127

approvals

UL Recognized 

cUL Recognized 

GOST 

cULus Recognized 

accessories

Seal

SACC-M12-SET/2,5-3,5 - 1436505



Torque tool

TSD 04 SAC - 1208429



TSD-M 1,2NM - 1212224



Connector - SACC-M12FS-4CON-PG7-M - 1681127

accessories

Screwdriver tools

TSD-M SAC-BIT ADAPTER - 1212600



SACC BIT M12-D20 - 1208445



Protective cap

PROT-M12 MS-PA-CHAIN - 1430899



Cable by the meter

SAC-4P-100,0-PUR/0,25 - 1501692



SAC-4P-100,0-PUR/0,34 - 1501663



Connector - SACC-M12FS-4CON-PG7-M - 1681127

accessories

SAC-4P-100,0-186/0,75 - 1457461



Drawings

Dimensioned drawing

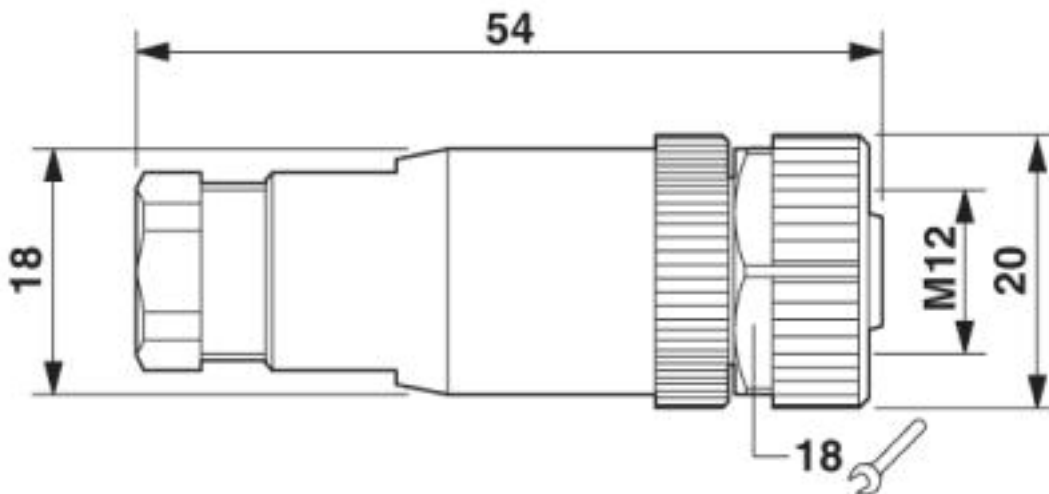

M12 x 1 socket, straight

Connector - SACC-M12FS-4CON-PG7-M - 1681127

Schematic diagram

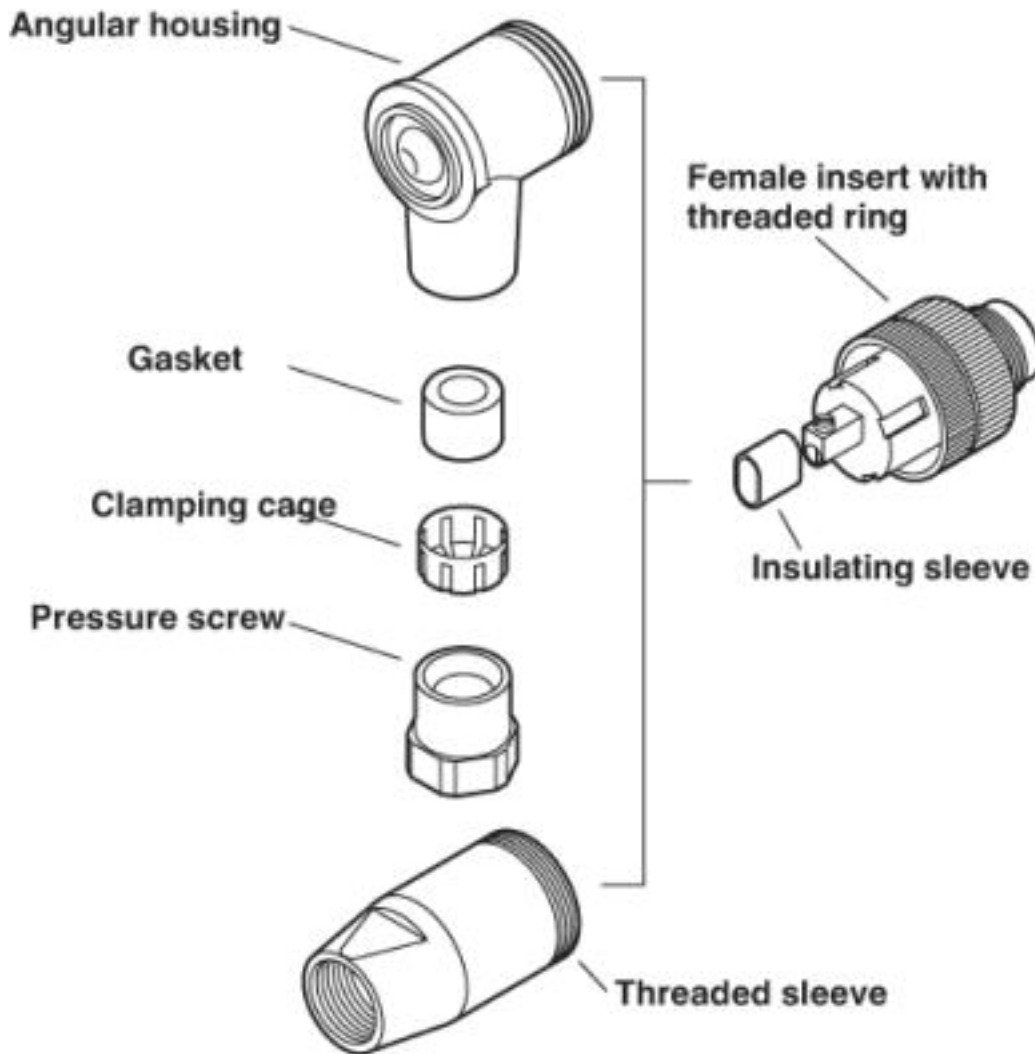

Male/Female M12

Connector - SACC-M12FS-4CON-PG7-M - 1681127

Schematic diagram

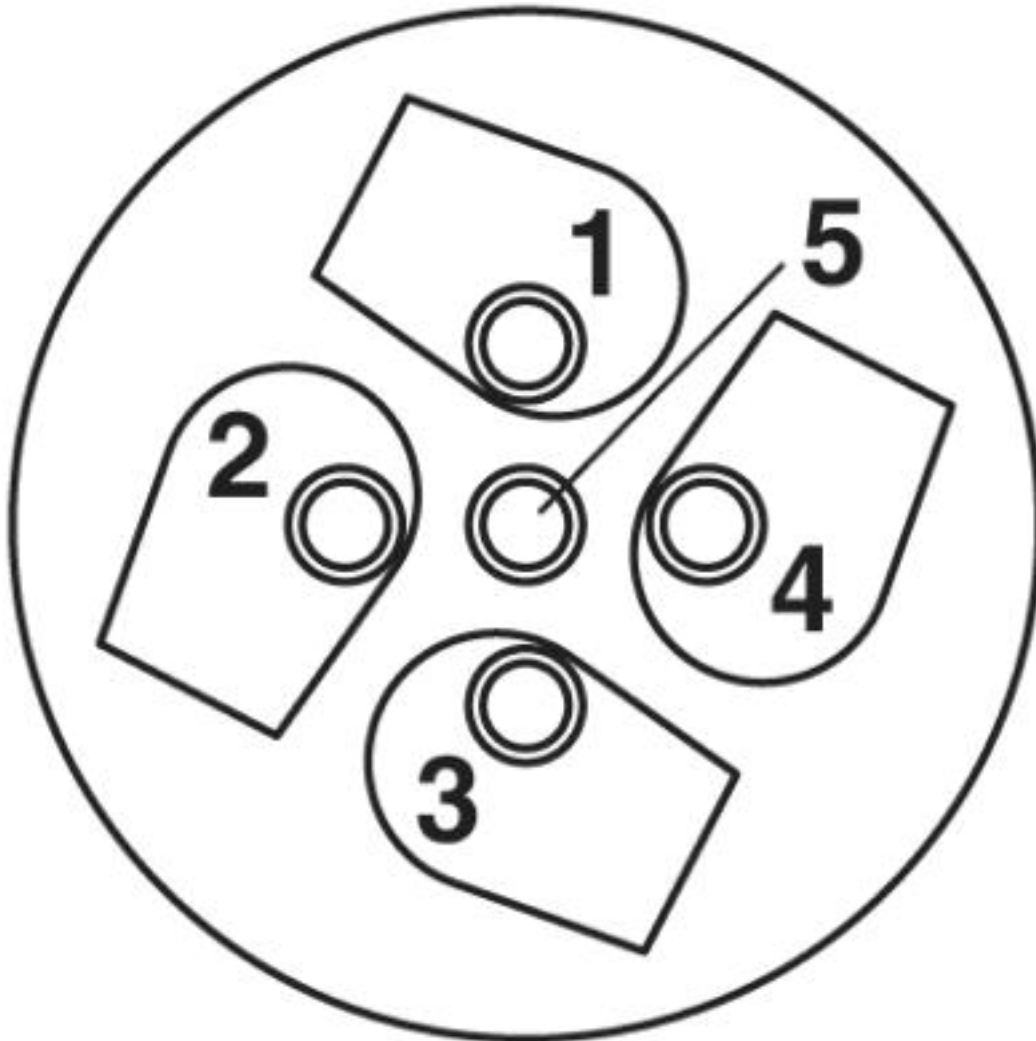

Cable connection side M12 (screw connection)

Connector - SACC-M12FS-4CON-PG7-M - 1681127

Schematic diagram

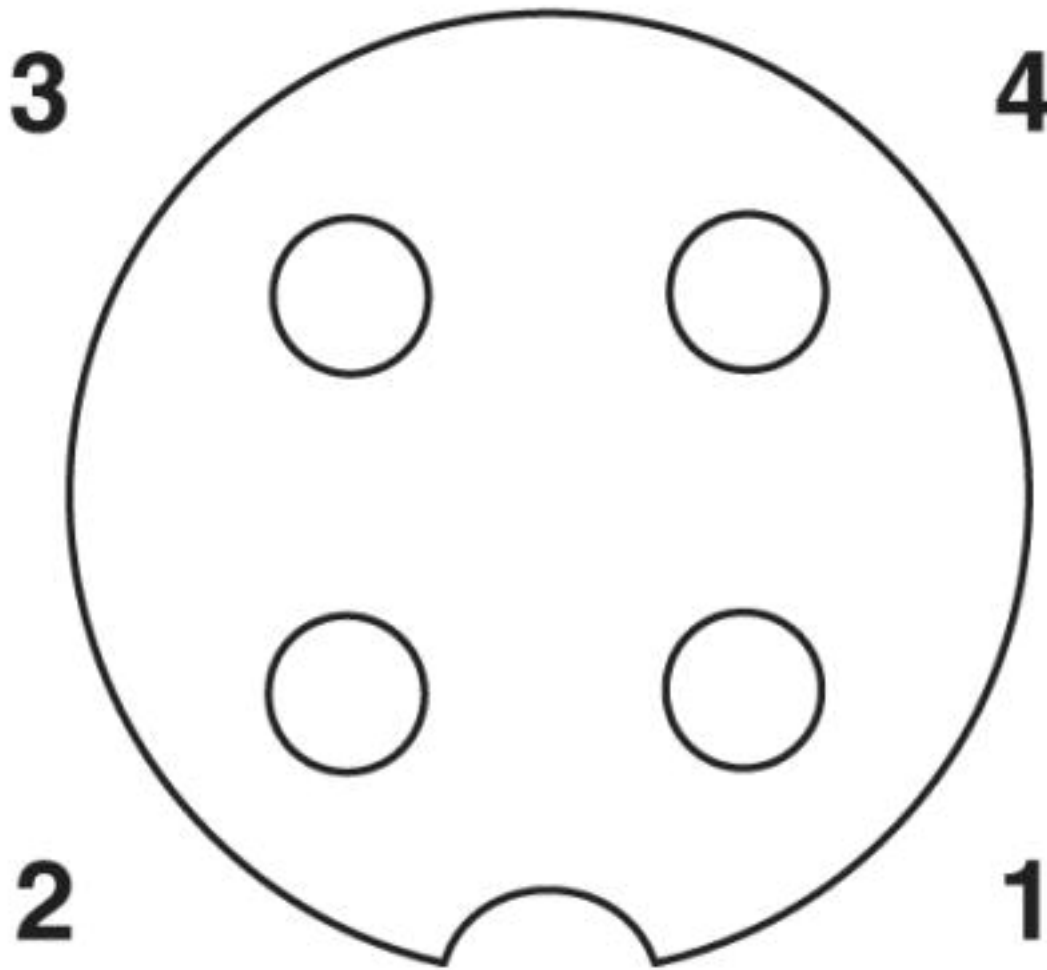

Pin assignment M12 socket, 4-pos., A-coded, view female side

© Phoenix Contact 2013 - all rights reserved
<http://www.phoenixcontact.com>