



KERN & Sohn GmbH

Ziegelei 1
D-72336 Balingen
E-Mail: info@kern-sohn.com

Phone: +49-[0]7433- 9933-0
Fax: +49-[0]7433-9933-149
Internet: www.kern-sohn.com

KERN
eco

Operating instructions Compact balance

KERN FOB-S

Version 1.2
08/2013
GB



FOB-S-BA-e-1312



KERN FOB-S

Version 1.2 08/2013

Operating instructions Compact balance

Contents

1	Technical data	3
2	Basic Information (General)	4
2.1	Proper use	4
2.2	Improper Use	4
2.3	Warranty	4
2.4	Monitoring of Test Resources.....	5
3	Basic Safety Precautions	5
3.1	Pay attention to the instructions in the Operation Manual.....	5
3.2	Personnel training.....	5
4	Transport and storage	5
4.1	Testing upon acceptance	5
4.2	Packaging / Return transport.....	5
5	Unpacking, Setup and Commissioning	6
5.1	Installation Site, Location of Use	6
5.2	Unpacking.....	6
5.2.1	Placing	7
5.2.2	Scope of delivery	7
5.2.3	Assembly/disassembly of the operating cover	7
5.3	Mains connection (optional).....	8
5.4	Battery operation	8
5.5	Initial Commissioning.....	9
5.6	Adjustment.....	9
5.7	Adjustment.....	9
6	Operating elements	11
6.1	Keyboard overview	11
6.2	Overview of display	11
7	Operation	12
7.1	Simple weighing	12
7.2	Taring.....	12
7.3	Weighing units switch-over.....	13
8	The menu	13
8.1	Call up menu	13
8.2	Navigation in the menu.....	13
8.3	Menu overview	13
8.4	Menu settings	14
8.4.1	Setting weighing units.....	14
8.4.2	Automatic switch-off function „AUTO OFF“ in stand-by mode	15
9	Error messages	17
10	Service, maintenance, disposal	17
10.1	Cleaning.....	17
10.2	Service, maintenance	17
10.3	Disposal.....	17
11	Instant help	18

1 Technical data

KERN	FOB 500-1S	FOB 5K1S
Readability (d)	0.1 g	1 g
Weighing range (max)	500 g	5,000 g
Reproducibility	0.1g	1 g
Linearity	± 0.2 g	± 2 g
Weighing Units	g, lb, oz, dwt, ozt	
Recommended adjustment weight, not added (class)	200 g / 500 g (M1)	2,000 g / 5,000 g (M1)
Warm-up time	10 min	
Stabilization time (typical)	2 sec.	
Operating temperature	+ 10° C + 40° C	
Humidity of air	25% - 95% (non-condensing)	
Housing (B x D x H) mm	170 x 150 x 40	
Weighing plate, stainless steel (mm)	120 x 150	
Weight kg (net)	650 g	
Auto off	2 min	
Battery	9 V block	
Secondary voltage powerpack	9 V / 100 mA	

2 Basic Information (General)

2.1 Proper use

The balance you purchased is intended to determine the weighing value of material to be weighed. It is intended to be used as a “non-automatic balance”, i.e. the material to be weighed is manually and carefully placed in the centre of the weighing pan.. As soon as a stable weighing value is reached the weighing value can be read.

2.2 Improper Use

Do not use balance for dynamic weighings. In the event that small quantities are removed or added to the material to be weighed, incorrect weighing results can be displayed due to the “stability compensation“. (Example: Slowly draining fluids from a container on the balance.)

Do not leave permanent load on the weighing pan. This may damage the measuring system.

Impacts and overloading exceeding the stated maximum load (max) of the balance, minus a possibly existing tare load, must be strictly avoided. Balance may be damaged by this.

Never operate balance in explosive environment. The serial version is not explosion protected.

The structure of the balance may not be modified. This may lead to incorrect weighing results, safety-related faults and destruction of the balance.

The balance may only be used according to the described conditions. Other areas of use must be released by KERN in writing.

2.3 Warranty

Warranty claims shall be voided in case

- Our conditions in the operation manual are ignored
- The appliance is used outside the described uses
- The appliance is modified or opened
- Mechanical damage and damage caused by media, liquids, natural wear and tear
- The appliance is improperly set up or incorrectly electrically connected
- The measuring system is overloaded

2.4 Monitoring of Test Resources

In the framework of quality assurance the measuring-related properties of the balance and, if applicable, the testing weight, must be checked regularly. The responsible user must define a suitable interval as well as type and scope of this test. Information is available on KERN's home page (www.kern-sohn.com) with regard to the monitoring of balance test substances and the test weights required for this. In KERN's accredited DKD calibration laboratory test weights and balances may be calibrated (return to the national standard) fast and at moderate cost.

3 Basic Safety Precautions

3.1 Pay attention to the instructions in the Operation Manual

Carefully read this operation manual before setup and commissioning, even if you are already familiar with KERN balances.

3.2 Personnel training

The appliance may only be operated and maintained by trained personnel.

4 Transport and storage

4.1 Testing upon acceptance

When receiving the appliance, please check packaging immediately, and the appliance itself when unpacking for possible visible damage.

4.2 Packaging / Return transport



- ⇒ Keep all parts of the original packaging for a possibly required return.
- ⇒ Only use original packaging for returning.
- ⇒ Prior to dispatch disconnect all cables and remove loose/mobile parts.
- ⇒ Reattach possibly supplied transport securing devices.
- ⇒ Secure all parts such as the glass wind screen, the weighing platform, power unit etc. against shifting and damage.

5 Unpacking, Setup and Commissioning

5.1 Installation Site, Location of Use

The balances are designed in a way that reliable weighing results are achieved in common conditions of use.

You will work accurately and fast, if you select the right location for your balance.

Therefore, observe the following for the installation site:

- Place the balance on a firm, level surface;
- Avoid extreme heat as well as temperature fluctuation caused by installing next to a radiator or in the direct sunlight;
- Protect the balance against direct draughts due to open windows and doors;
- Avoid jarring during weighing;
- Protect the balance against high humidity, vapours and dust;
- Do not expose the device to extreme dampness for longer periods of time. Non-permitted condensation (condensation of air humidity on the appliance) may occur if a cold appliance is taken to a considerably warmer environment. In this case, acclimatize the disconnected appliance for ca. 2 hours at room temperature.
- Avoid static charge of goods to be weighed or weighing container.

Major display deviations (incorrect weighing results) may be experienced should electromagnetic fields (e.g. due to mobile phones or radio equipment), static electricity accumulations or instable power supply occur. Change location or remove source of interference.

5.2 Unpacking

Carefully remove the weighing balance from the packaging and install it at the designated work place.

5.2.1 Placing



The balance must be installed in a way that the weighing plate is exactly in horizontal position.

5.2.2 Scope of delivery

Serial accessories:

- Balance
- Weighing pan
- Mains adapter (optional)
- Protective working cover
- Operating instructions

5.2.3 Assembly/disassembly of the operating cover

	<p>⇒ Unblock the plate of the scales by turning it in the direction indicated by the arrow.</p>
	<p>⇒ Remove/put on the operating cover</p>

5.3 Mains connection (optional)

The balance may be operated via the optional mains adapter. The stated voltage value must be the same as the local voltage.

Only use original KERN mains adapters. Using other makes requires consent by KERN.

5.4 Battery operation

Remove battery cover at the lower side of the casing. Insert 9 V block. Reinsert the battery cover.

In the menu you can activate the AUTO-OFF function (see chap. 8.4.2 "Automatic switch-off function"). According to the selected settings, the balance switches automatically off in order to spare the battery.

The empty battery is indicated on the display by „**LobAt**“. Press button  and replace the batteries immediately.

If the balance is not used for a longer time, take out the battery and store it separately. Leaking battery liquid could damage the balance.

5.5 Initial Commissioning

In order to obtain exact results with the electronic balances, your balance must have reached the operating temperature (see warming up time chap. 1). During this warming up time the balance must be connected to the power supply (mains or battery).

The accuracy of the balance depends on the local acceleration of gravity. Strictly observe hints in chapter Adjustment.

5.6 Adjustment

As the acceleration value due to gravity is not the same at every location on earth, each balance must be coordinated - in compliance with the underlying physical weighing principle - to the existing acceleration due to gravity at its place of location (only if the balance has not already been adjusted to the location in the factory). This adjustment process must be carried out for the first commissioning, after each change of location as well as in case of fluctuating environment temperature. To receive accurate measuring values it is also recommended to adjust the balance periodically in weighing operation.

5.7 Adjustment





The adjustment should be made with the recommended adjustment weights (see chap. 1 "Technical data").

Procedure when adjusting:

Observe stable environmental conditions.

A warming up time (see chapter 1; Technical Data) is required for stabilization.

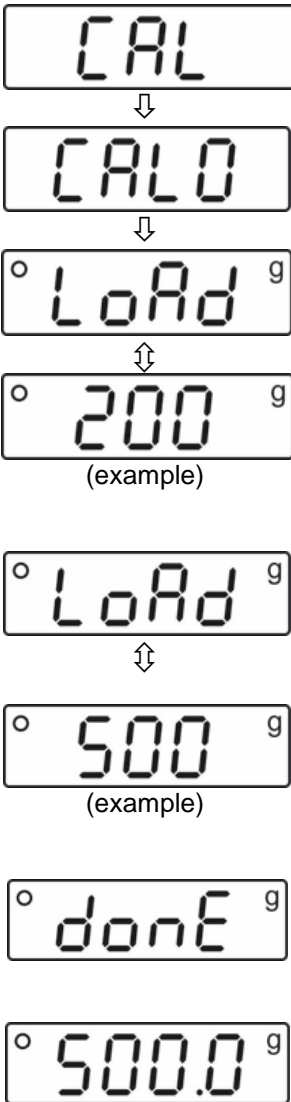
Ensure that there are no objects on the weighing plate.



Balance display	Operation
	<p>⇒ Start balance by pressing </p> <p>The balance carries out an autotest and changes then into the weighing mode, the zero display „0.0“ appears</p>
	<p>⇒ Press  for approx. 3 seconds, „CAL“ appears shortly, then „CAL 0“ and after that „LoAd“ is displayed alternately with the value of the first adjustment weight.</p> <p>⇒ Place the first adjustment weight in the middle of the weighing plate.</p> <p>After a short time the value of the second adjustment weight is displayed alternately with „LoAd“</p> <p>⇒ Remove the the first adjustment weight from the weighing plate and place the second adjustment weight in the middle of the weighing plate. Adjustment occurs automatically after standstill control.</p> <p>„donE“ will be shortly displayed. Then the value of the second adjustment weight will be displayed.</p> <p>Adjustment process has been finished successfully. The balance is now in weighing mode.</p>

6 Operating elements

6.1 Keyboard overview

Buttons specification:



Key	Description	Pressed once and released	
	[ON/OFF]	<ul style="list-style-type: none"> Turn on/off 	
	[TARE]	<ul style="list-style-type: none"> Taring 	In menu: <ul style="list-style-type: none"> Passing through menu items from top to bottom
	[UNIT]	<ul style="list-style-type: none"> Weighing units switching over Invoke adjustment 	<ul style="list-style-type: none"> Passing through menu items from left to right



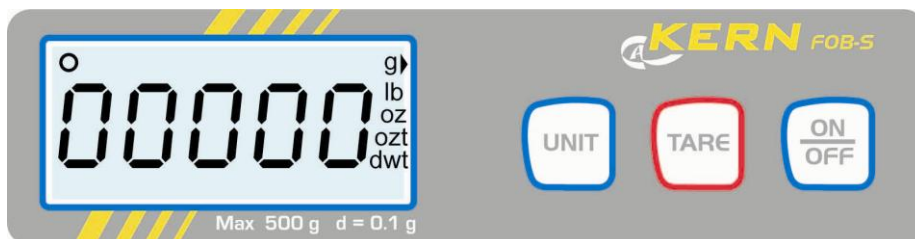



6.2 Overview of display



Display	Description
g, lb, oz, dwt, ozt	Display weighing units
○	Stability display





7 Operation

7.1 Simple weighing

Balance display	Operation
	⇒ Start balance by pressing  The balance will carry out a self-test. „Wait for 0.0 “ display
 (example) 	⇒ Should the balance not display exactly „ 0.0 “ despite empty weighing pan, press the  button. The balance returns to „ 0.0 “
	⇒ Place goods to be weighed on balance. Wait until the stability display appears. Read weighing result.
	⇒ To switch off the balance press shortly  .

7.2 Taring

The dead weight of any weighing container may be tared away by pressing a button, so that the following weighing procedures show the net weight of the goods to be weighed.

Balance display	Operation
 (example)	⇒ Deposit weighing vessel. The weight of the container is displayed.
	⇒ Press  , the zero display appears. The weight of the container is now internally saved.
 (example)	⇒ Place goods to be weighed in the weighing container. The net weight of the goods to be weighed is displayed.

7.3 Weighing units switch-over

According to the requirements the balance can be switched over into different units. These are set in the menu (see chap. 8.4.1).



In weighing mode, use  to change between the set units.

8 The menu

8.1 Call up menu

The menu is invoked by pressing the  button for approx. 3 seconds in weighing mode.

8.2 Navigation in the menu

Key	Direction in the menu	Description
	↓	<ul style="list-style-type: none"> • Passing through menu items from top to bottom • Confirm selection
	→	<ul style="list-style-type: none"> • Passing through menu items from left to right

8.3 Menu overview

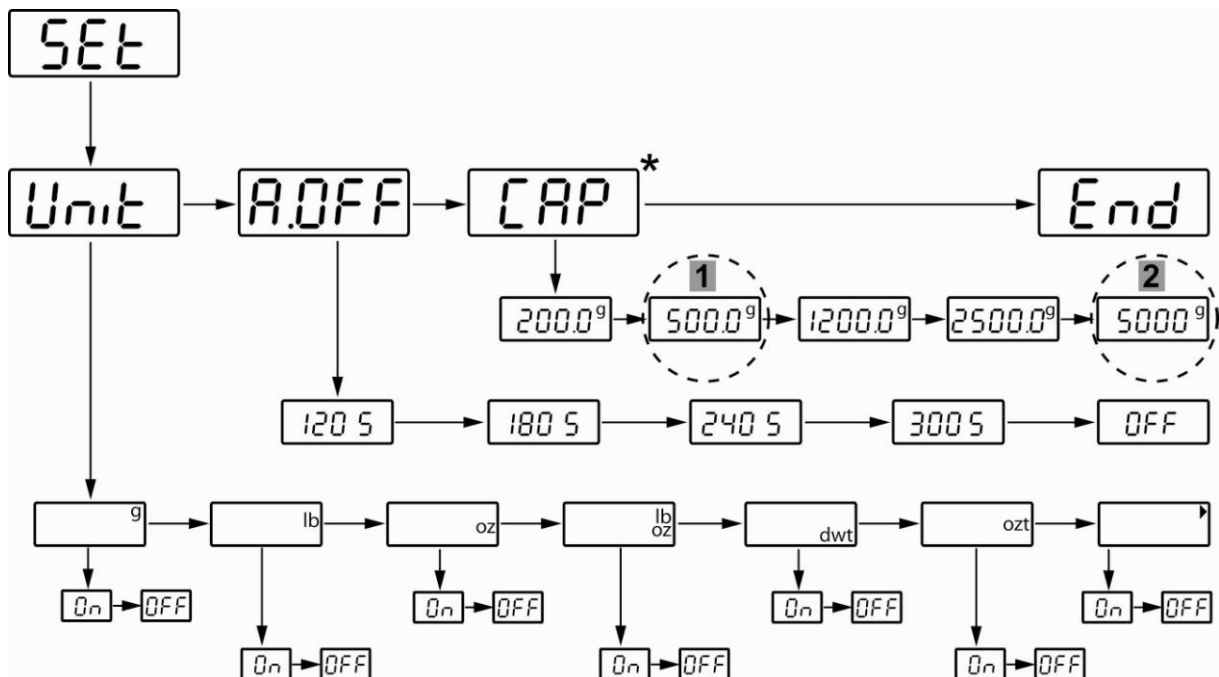









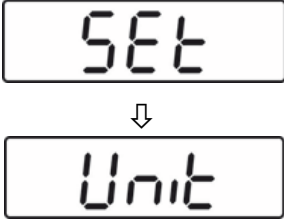



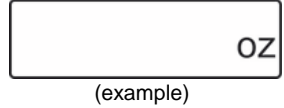





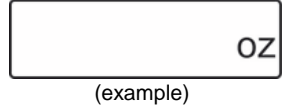





* Preset values may only be modified by trained and specialized personnel.

1	Model FOB 500-1S
2	Model FOB 5K1S

8.4 Menu settings

8.4.1 Setting weighing units





Balance display	Operation
	⇒ In weighing mode press  button for approx. 3 seconds. „SEt“, followed by „Unit“ is displayed
	⇒ Press  again, the weighing unit „g“ is displayed
	⇒ Use  to change to the desired unit
	⇒ Press  , „OFF“ will be shown.
	⇒ Use  to change to „On“
	⇒ Press  , the selected unit will be displayed thus being set.
	⇒ Press  repeatedly until „Unit“ is displayed





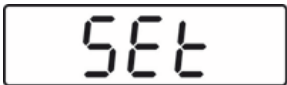



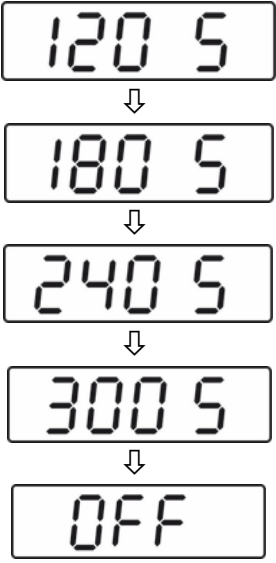

	⇒ Press  , „A.Off“ will be shown
	⇒ Press  , „CAP.“ is displayed
	⇒ Press  , „End“ is displayed
	⇒ Use  to return to weighing mode
 (example)	⇒ Use  to change between the set units

	In order to switch off the units display, proceed as described above and set the selected unit to „Off“.
---	--

8.4.2 Automatic switch-off function „AUTO OFF“ in stand-by mode



The balance offers the possibility of the automatic switch-off, when the balance is in stand-by mode. The switch-off time may be selected as follows:

Balance display	Operation
 ↓ 	⇒ In weighing mode press  button for approx. 3 seconds. „SEt“, followed by „Unit“ is displayed
	⇒ Press  , „AOFF“ is displayed

	<p>⇒ Press , the current setting will be displayed.</p> <p>⇒ Use  to select the desired setting: 120s = Auto off after 120 seconds 180s = Auto off after 180 seconds 240s = Auto off after 240 seconds 300s = Auto off after 300 seconds OFF = Auto off switched off</p>
	<p>⇒ Use  to take over the selected items, „A OFF“ is displayed</p>
	<p>⇒ Press , „CAP.“ is displayed</p>
	<p>⇒ Press  again , „End“ is displayed</p>
	<p>⇒ Press , the balance will return into weighing mode. The setting is saved.</p>

	<p>The auto-off function is only possible in battery operation. In mains operation this function is turned off.</p>
---	---

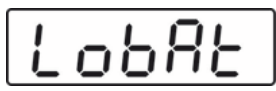
9 Error messages

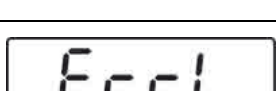
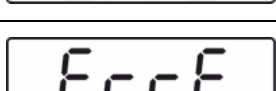
	Battery empty	Insert new battery or connect the balance to power supply
	Weighing range exceeded	Remove load and if necessary press  to reset balance to zero
	Zeroing range not reached	Increase the load, if the error message remains, please contact your retailer
	Software error	Contact your retailer

10 Service, maintenance, disposal

10.1 Cleaning

Before cleaning, please disconnect the appliance from the operating voltage.

Please do not use aggressive cleaning agents (solvents or similar agents), but a cloth dampened with mild soap suds. Ensure that no liquid penetrates into the device and wipe with a dry soft cloth.

Loose residue sample/powder can be removed carefully with a brush or manual vacuum cleaner.

Spilled weighing goods must be removed immediately.

10.2 Service, maintenance

The appliance may only be opened by trained service technicians who are authorized by KERN.

Before opening, disconnect from power supply.

10.3 Disposal

Disposal of packaging and appliance must be carried out by operator according to valid national or regional law of the location where the appliance is used.

11 Instant help

In case of an error in the program process, briefly turn off the balance and disconnect from power supply. The weighing process must then be restarted from the beginning.

Help:

Fault

Possible cause

The displayed weight does not glow.

- The balance is not switched on.
- The mains supply connection has been interrupted (mains cable not plugged in/faulty).
- Power supply interrupted.
- (Rechargeable) batteries are inserted incorrectly or empty
- No (rechargeable) batteries inserted.

The displayed weight is permanently changing

- Draught/air movement
- Table/floor vibrations
- Weighing pan has contact with other objects.
- Electromagnetic fields / static charging (choose different location/switch off interfering device if possible)

The weighing result is obviously incorrect

- The display of the balance is not at zero
- Adjustment is no longer correct.
- Great fluctuations in temperature.
- Warm-up time was ignored.
- Electromagnetic fields / static charging (choose different location/switch off interfering device if possible)

Should other error messages occur, switch balance off and then on again. If the error message remains inform manufacturer.