



KERN & Sohn GmbH

Ziegelei 1
D-72336 Balingen
email: info@kern-sohn.com

Phone: +49-[0]7433- 9933-0
Fax: +49-[0]7433-9933-149
Internet: www.kern-sohn.com

Operating instructions Electronic Crane Scales

Logbook
Regular maintenance and care

KERN HFB

Version 1.2
10/2012
GB



HFB-BA-e-1212



KERN HFB

Version 1.2 10/2012

Operating instructions / logbook Electronic Suspending Balance

Table of Contents

1.	Technical Data	3
1.1	Dimensions	4
1.2	EC-Declaration of -Conformity	5
2.	General Safety Instructions	6
3.	The crane scales at a glance	9
3.1	Overview	9
3.2	Display	10
3.3	Keyboard	11
3.4	Numerical input via the navigation buttons	11
3.5	Radio remote control	12
3.6	Sticker	12
4.	Commissioning	13
4.1	Unpacking	13
4.2	Checking the original dimensions	14
4.3	Rechargeable battery operation	14
4.4	Suspending the balance	15
5.	Operation	16
5.1	Safety instructions	16
5.2	Loading the crane scales	17
5.3	Turn on/off	20
5.4	Setting the balance to zero	20
5.5	Taring	21
5.6	Weighing	21
5.7	Record weight value (freeze)	22
6.	Menu	23
7.	Adjustment	25
8.	Error messages	26
9.	Cleaning, Maintenance and Disposal	27
9.1	Cleaning and Disposal	27
9.2	Regular maintenance and care	27
9.3	Checklist „regular maintenance“, (see chapter 9.2)	31
9.4	12-month maintenance (see chap. 9.2)	35
10.	Appendix	36
10.1	Checklist „Enhanced maintenance“ (General revision)	36
10.2	List „spare parts and repair of safety-relevant parts“	37

1. Technical Data

KERN	HFB 150K50	HFB 300K100	HFB 600K200
Readability (d)	50 g	100 g	200 g
Weighing range (max)	150 kg	300 kg	600 kg
Taring range (subtractive)	150 kg	300 kg	600 kg
Reproducibility	50 g	100 g	200 g
Linearity	±100 g	±200 g	±400 g
Recommended adjustment weight, not added (class)	150 kg (M1)	300 kg (M1)	500 kg (M1)
Stabilization time	2 s		
Precision	0.2 % of max.		
Warm-up time	10 min		
Units	kg, lb		
Allowable ambient temperature	0...+40 °C		
Relative humidity	10 to 80 %, non-condensing		
Supply voltage	220V - 240V AC 50 Hz		
Secondary voltage powerpack	9V, 800 mA		
Rechargeable battery (standard equipment)	6 V 1.2 A Service life – background illumination ON 30 h Service life – background illumination OFF 40 h Loading time 12 h		
Display	Digit height 25 mm		
Housing size W x D x H	163 mm x 126 mm x 159 mm		
Housing material	Synthetic material		
Material hook and shackle	Nickel plated steel		
Net weight	2 kg		
Remote control (standard equipment)	Battery Size 23A (1 x 1.5V) W x D x H 48 x 16 x 95 mm		

1.1 Dimensions

English

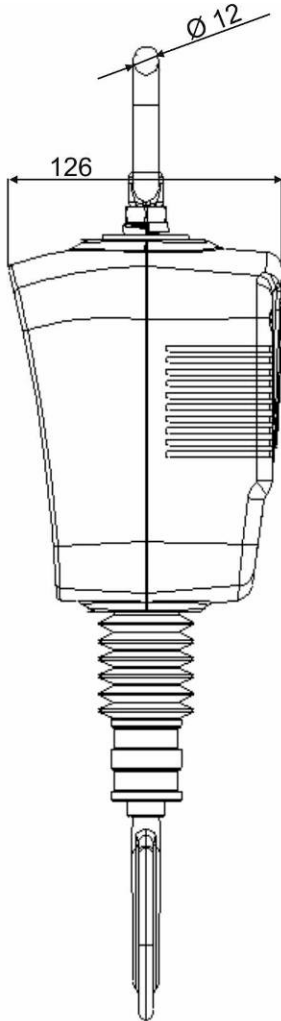
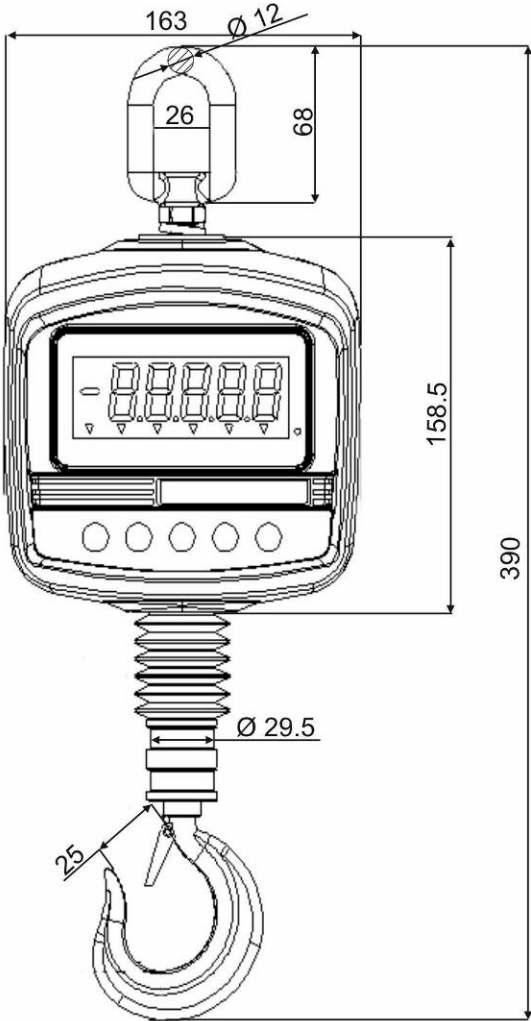

1.2 EC-Declaration of -Conformity



KERN & Sohn GmbH

D-72322 Balingen-Frommern

Postfach 4052

E-Mail: info@kern-sohn.de

Tel: 0049-[0]7433- 9933-0

Fax: 0049-[0]7433-9933-149

Internet: www.kern-sohn.de

EC-Declaration of -Conformity

EG-Konformitätserklärung
EC- Déclaration de conformité
EC-Dichiarazione di conformità
EC- Declaração de conformidade
EC-Deklaracja zgodności

EC-Declaration of -Conformity
EC-Declaración de Conformidad
EC-Conformiteitverklaring
EC- Prohlášení o shode
EC-Заявление о соответствии

D	Konformitäts- erklärung	Wir erklären hiermit, dass das Produkt, auf das sich diese Erklärung bezieht, mit den nachstehenden Normen übereinstimmt.
GB	Declaration of conformity	We hereby declare that the product to which this declaration refers conforms with the following standards.
CZ	Prohlášení o shode	Tímto prohlašujeme, že výrobek, kterého se toto prohlášení týká, je v souladu s níže uvedenými normami.
E	Declaración de conformidad	Manifetamos en la presente que el producto al que se refiere esta declaración está de acuerdo con las normas siguientes
F	Déclaration de conformité	Nous déclarons avec cela responsabilité que le produit, auquel se rapporte la présente déclaration, est conforme aux normes citées ci-après.
I	Dichiarazione di conformità	Dichiariamo con ciò che il prodotto al quale la presente dichiarazione si riferisce è conforme alle norme di seguito citate.
NL	Conformiteit- verklaring	Wij verklaren hiermede dat het product, waarop deze verklaring betrekking heeft, met de hierna vermelde normen overeenstemt.
P	Declaração de conformidade	Declaramos por meio da presente que o produto no qual se refere esta declaração, corresponde às normas seguintes.
PL	Deklaracja zgodności	Niniejszym oświadczamy, że produkt, którego niniejsze oświadczenie dotyczy, jest zgodny z poniższymi normami.
RUS	Заявление о соответствии	Мы заявляем, что продукт, к которому относится данная декларация, соответствует перечисленным ниже нормам.

Electronic Balance: KERN HFB

EU Directive	Standards
2004/108/EC	EN55022: 2006 A1:2007 EN61000-3-3:1995+A1:2001+A2:2005 EN55024: 1998+A1:2001+A2:2003
2006/95/EC	EN 60950-1:2006 EN 60065:2002+A1:2006
2006/42/EC	EN13155:2003+A2:2009
2005 / 32 / EC	

Date: 04.03.2011

Signature: 

KERN & Sohn GmbH
Management

KERN & Sohn GmbH, Ziegelei 1, D-72336 Balingen, Tel. +49-[0]7433/9933-0
Fax +49-[0]7433/9933-149, E-Mail: info@kern-sohn.com, Internet: www.kern-sohn.com

2. General Safety Instructions

Duties of the owner-operator

Follow the national accident prevention regulations as well as the working, operating and safety regulations of the owner-operator.

- Observe all safety regulations of the crane manufacturer.
- The balance may only be used for the proposed purpose. Any type of use which is not specified in these operating instructions, will be considered as improper use. The customer is solely responsible for material damage and injury of persons resulting from an improper use, Messrs. KERN & Sohn will not be liable under any circumstance.

Messrs. KERN & Sohn cannot be held liable, if the crane scales are modified or used improperly and if damage is resulting from such use.

- Carry out regular maintenance and care of the crane scales, the crane and the load suspension devices (see chapter 9).
- Log the test result and keep it in the logbook.

Organizational measures

- Only trained and instructed staff may operate the balance.
- Make sure that the operating instructions are kept nearby the operation site of the crane scales.
- Assembly, commissioning and maintenance should only be carried out by trained specialists.
- Repair of safety-relevant pieces may only be carried out by KERN or by service partners authorized by Messrs. KERN. (competence certificate or training).
- Use original spare parts only.
- All repairs and spare parts must be documented by the service partner (see list, chap. 10.3).
- All maintenance must be documented (see checklist chap. 9.3).
- Load suspending components may only be exchanged as a complete spare parts set. The dimensions of the new components must be noted (see checklist chapter 9.3).

Ambient conditions

- Never operate the crane scales in explosive environment. The serial version is not explosion protected.
- Operate the crane scales only under environmental conditions as specified in these operating instructions (especially in chapter 1 „Technical data“).
- Do not expose the crane scales to strong humidity. Non-permitted condensation (condensation of air humidity on the appliance) may occur if a cold appliance is taken to a considerably warmer environment. In this case, acclimatize the disconnected appliance for ca. 2 hours at room temperature.
- Do not operate the crane scales in corrosive environment.
- Protect the crane scales against high humidity, vapours and dust.

- Major display deviations (incorrect weighing results) may be experienced should electromagnetic fields (e.g. due to mobile phones or radio equipment), static electricity accumulations or instable power supply occur. Change location or remove source of interference.

Proper use

The balance you purchased is intended to determine the weighing value of material to be weighed. It is intended to be used as a “non-automatic“ balance, i.e. the material to be weighed is suspended on the crane hook only vertically, manually, carefully and without jerks. As soon as a stable weighing value is reached the weighing value can be read.

- Use the crane scales only for lifting and weighing of freely movable loads.
- Danger of injury due to improper use. Not allowed are e.g.:
 - Exceeding the allowed nominal load of crane, crane scales or any type of load attachment devices
 - Conveying persons,
 - Pulling loads over an inclined surface,
 - Tearing-off, pulling or towing loads.
- Modifications or reconstructions of the crane scales or of the crane are not allowed.

Improper Use

Do not use balance for dynamic weighing. In the event that small quantities are removed or added to the material to be weighed, incorrect weighing results can be displayed due to the “stability compensation“ in the balance. (Example: Slowly draining fluids from a container suspended on the balance.) Do not leave permanent load suspended on the balance. This may damage the measuring system as well as safety-relevant parts.

The balance may only be used according to the described conditions. Other areas of use must be released by KERN in writing.

Warranty

Warranty claims shall be voided in case

- Our conditions in the operation manual are ignored
- The appliance is used outside the described uses
- The appliance is modified or opened
- Mechanical damage and damage caused by media, liquids,
- Natural wear and tear
- The appliance is improperly set up or incorrectly electrically connected
- The measuring system is overloaded

Safe working

- Do not stand underneath suspended loads!
- Position the crane in a way that the load is lifted vertically.
- When working with the crane and crane scales wear personal safety equipment (helmet, safety shoes etc.).

Monitoring of Test Resources

In the framework of quality assurance the measuring-related properties of the balance and, if applicable, the testing weight, must be checked regularly. The responsible user must define a suitable interval as well as type and scope of this test. Information is available on KERN's home page (www.kern-sohn.com) with regard to the monitoring of balance test substances and the test weights required for this. In KERN's accredited DKD calibration laboratory test weights and balances may be calibrated (return to the national standard) fast and at moderate cost.

Testing upon acceptance

When receiving the appliance, please check packaging immediately, and the appliance itself when unpacking for possible visible damage.

Initial Commissioning

In order to obtain exact results with the electronic balances, your balance must have reached the operating temperature (see warming up time chap. 1).

During this warming up time the balance must be connected to the power supply (mains, accumulator or battery).

The accuracy of the balance depends on the local acceleration of gravity.

Strictly observe hints in chapter Adjustment.

Check the original dimensions, see chap. 4.2.

Shutdown and storage

- Take off the crane scales from the crane and dismantle all load attachment devices from the crane scales.
- Do not store the crane scales at open air

3. The crane scales at a glance

The crane scales are a multi-purpose and cost-saving solution for overhead weighing applications such as e.g. recycling, metal processing, machine engineering, transport and logistics.

With the radio remote control operation will be more comfortable yet.

3.1 Overview

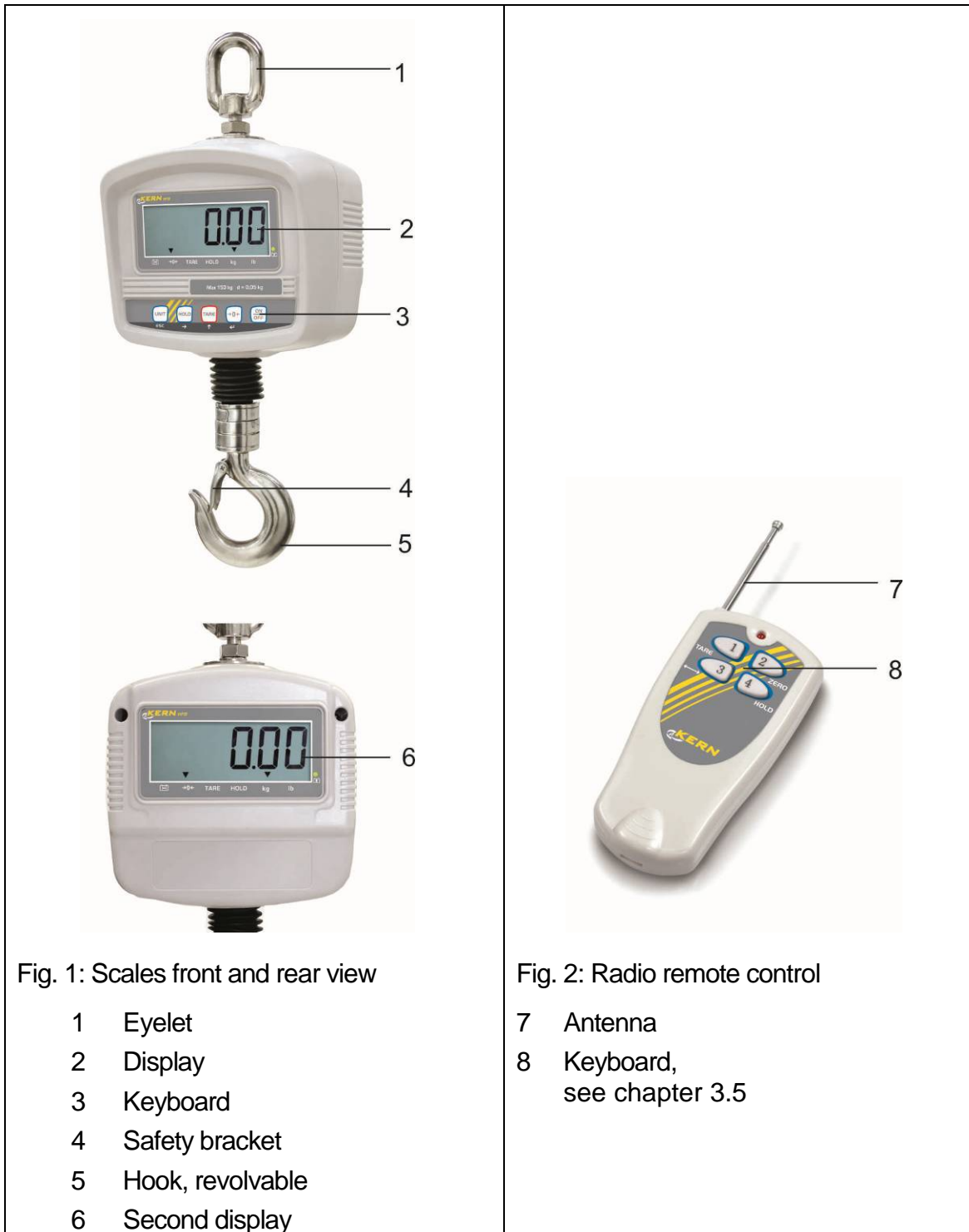

Fig. 1: Scales front and rear view

- 1 Eyelet
- 2 Display
- 3 Keyboard
- 4 Safety bracket
- 5 Hook, revolvable
- 6 Second display

Fig. 2: Radio remote control

- 7 Antenna
- 8 Keyboard,
see chapter 3.5

3.2 Display



[▼] over the symbol appears if

	the capacity of the rechargeable battery will soon be exhausted. The balance will be ready to operate for about another 30 minutes, then it will switch off automatically.
a	the weight is in the area around the zero point
TARE	the scales have been tared
HOLD	the data-hold function is active
kg	the current weighing unit is „kg“
lb	the current weighing unit is „lb“
The LED display above is illuminated when the battery is being recharged.	

3.3 Keyboard

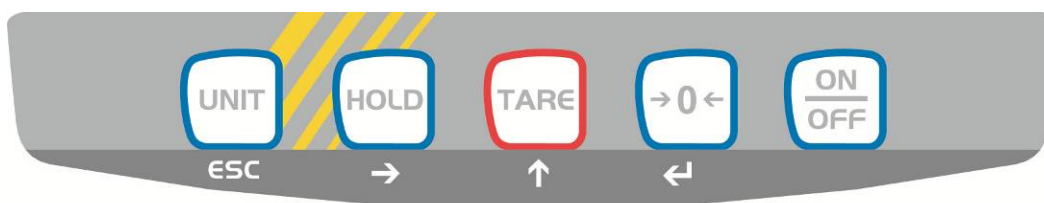

Button	Designation	Description of function
	UNIT button	Switch-over weighing unit. Exit menu, back to weighing mode.
	HOLD button	The weight display is „frozen“ via the HOLD button until the HOLD -button is pressed anew.
	TARE button	Taring
	ZERO button	Corrects the zero point of the balance. The display is set to zero.
	ON/OFF key	Turn on or off the balance

3.4 Numerical input via the navigation buttons

Button	Navigation button	Function
	ESC	Delete
	→	Digit selection
	↑	Increase flashing digit
	←	Terminate input

3.5 Radio remote control

The balance can be operated by the radio remote control like by a keyboard. All functions (excepted **ON/OFF**) can be selected.

The red LED must light up when any button is pressed. If it does not light up, the batteries in the remote control must be exchanged.

Range on free surface (free of buildings) approx. 20 m.

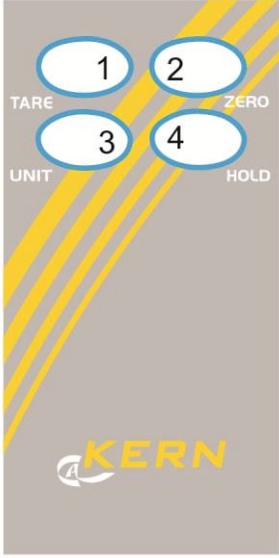
	1	Taring
	2	Zeroing
	3	Switch-over weighing unit
	4	The weight display is „frozen“ via the HOLD button until the HOLD -button is pressed anew.

3.6 Sticker



- ⇒ Do not stand or go under suspended loads.
- ⇒ Do not use on building sites.
- ⇒ Suspended loads have to be observed constantly.





(Example)

- ⇒ Do not exceed the nominal load of crane scales.



- ⇒ The product meets the requirements of the German Equipment and Product Safety Act.

4. Commissioning

	<p>☞ Always observe chapter 2 „General Safety Instructions“!</p>
	<p>☞ Before every use check the firm fit of the nut (A) and lock washer (B), see chap. 9.2 „Regular maintenance“.</p> <div style="text-align: center;">  </div>

4.1 Unpacking

 <p>SAFETY INSTRUCTIONS for protection against break</p>	<p>Once delivered and unpacked, crane scales will not be taken back.</p>
	<p>The crane scales have been sealed by Messrs. KERN.</p> <p>⇒ The eyelet and the hooks are sealed by Sella tape.</p> <p>⇒ The packaging is also sealed by adhesive tape.</p>
	<p>☞ Broken seal obliges to purchase.</p>
	<p>Thanks for your comprehension. Your KERN Quality assurance team</p>

Only use original packaging for returning.

⇒ Make sure that all parts are completely present.

- Crane scales
- Mains adapter
- Remote control
- Operating instructions (logbook)

4.2 Checking the original dimensions

- ⇒ Enter the original dimensions of the product datasheet into the grey fields of the checklist chap. 9.3.
- ⇒ Realization of all safety checks, see chapter 9.2 „Regular maintenance after three months“
- ⇒ Enter all data (date, tester, results) in the first line under „Inspection before first use“ in the checklist (see chapter 9.3)

 CAUTION	If the dimensions of your first safety inspection do not match those of KERN, the balance must not be put into operation. In this case please contact a service partner authorized by Messrs. KERN.
---	---

4.3 Rechargeable battery operation

 CAUTION	Material damage on crane scales <ul style="list-style-type: none">⇒ Only use the delivered mains adapter.⇒ Make sure that the mains adapter, the cable and the mains plug are in a perfect condition.⇒ Do not use the crane scales during the loading process.
--	---

Before the first use, the rechargeable battery should be charged by connecting it to the mains power cable for at least 15 hours. The operating time of the rechargeable battery is approx. 40 hours. In case of a background illumination the operating time is reduced. Charging time until complete recharging is approx. 12h.

To save the rechargeable battery, in the menu (see chap. 6) the automatic switch-off function „F7 off“ can be activated, switch-off time selectable after 0, 3, 5, 10, 20 minutes.

If in the display an arrow [▼] appears above the battery symbol  or „bat lo“, the capacity of the rechargeable battery soon will be exhausted. The balance will be ready to operate for about another 30 minutes, then it will switch off automatically. Connect the power cable as soon as possible to load the rechargeable battery.

The LED display above  informs you during loading about the loading status of the rechargeable battery.

red: Voltage has dropped below prescribed minimum.

green: Rechargeable battery is completely charged

yellow: The rechargeable battery is loaded.

When the crane scales are out of operation for a longer period, remove the battery.

4.4 Suspending the balance

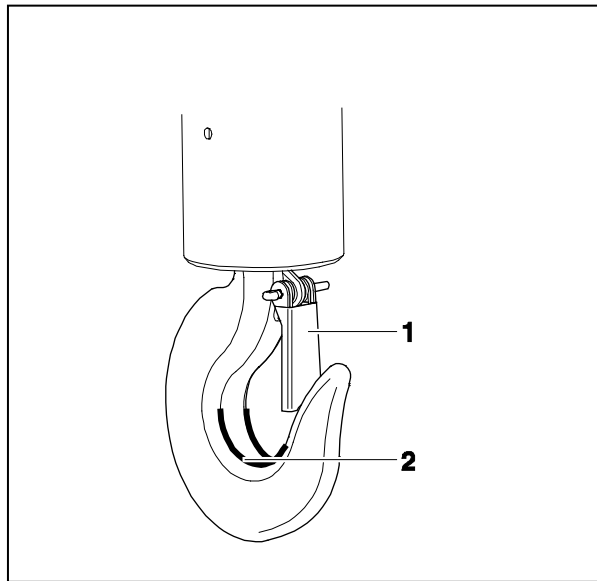

Condition





The crane needs a safety bracket (1) that the unloaded crane scales cannot fall down.

If the safety bracket is missing or damaged, please contact the crane manufacturer in order to receive a hook with this safety equipment.

- ⇒ Suspend the crane scales on the lower hook of a crane and close the safety bracket.
The crane scale's upper eyelet should rest in the saddle (2).

5. Operation

5.1 Safety instructions

	 <p>Risk of injury due to falling loads!</p> <p>DANGER</p>
  <p>(Example)</p>	<ul style="list-style-type: none"> ⇒ Always work with particular care according to the general rules for crane operation. ⇒ Check all parts (hook, eyelet, rings, rope slings, cables, chains etc.) for excessive wear or damage ⇒ If faults can be seen on the safety bracket of the hook or if it is missing completely, the scales must not be used. ⇒ Work only with appropriate speed. ⇒ Always avoid vibrations and horizontal forces. Avoid any kind of shock, torsion and oscillating (e.g. caused by inclined suspending). ⇒ Do not use the crane scales for transport of loads ⇒ Do not stand or go under suspended loads. ⇒ Do not use on building sites. ⇒ Suspended loads have to be observed constantly. ⇒ Do not exceed the nominal load of crane, crane scales or any kind of load attachment devices at the crane scales.

5.2 Loading the crane scales

For good weighing results observe the following, illustrations see next page:

- ⇒ Only use load attachment devices which guarantee a one-spot suspension and where the scales can be suspended freely.
- ⇒ Do not use too large load attachment devices which do not guarantee any one-spot suspension.
- ⇒ Do not use multiple suspensions.
- ⇒ Do not pull or push the load or the loaded balance.
- ⇒ Do not pull the hook horizontally.

Loading the balance

1. Position the hook of the crane scales over the load.
2. Move downwards the crane scales until the load can be suspended on the hook of the balance. Reduce the speed when the respective height is going to be reached.
3. Suspend the load on the hook. Ensure that the safety bracket is closed. If the load is fixed by slings, ensure that the slings rest completely on the saddle of the balance hook.
4. Lift-off the load slowly.

When the load is fixed by slings, ensure that the load is well balanced on both sides and that the slings are correctly positioned

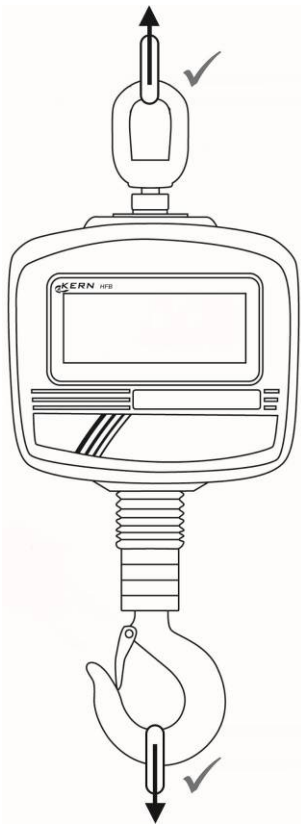

Only use load attachment devices which guarantee a one-point suspension and where the scales can be suspended freely.

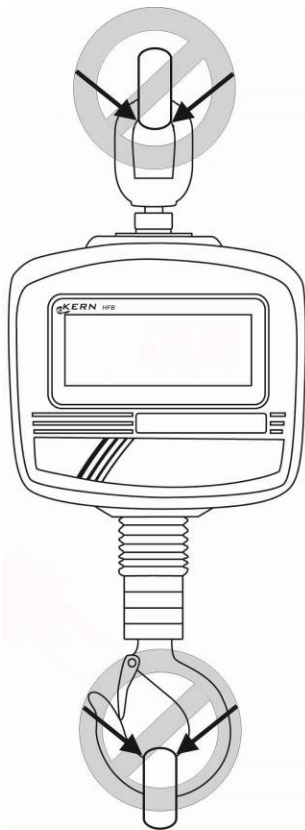

Do not use too large load attachment devices which cannot guarantee a one-point suspension.

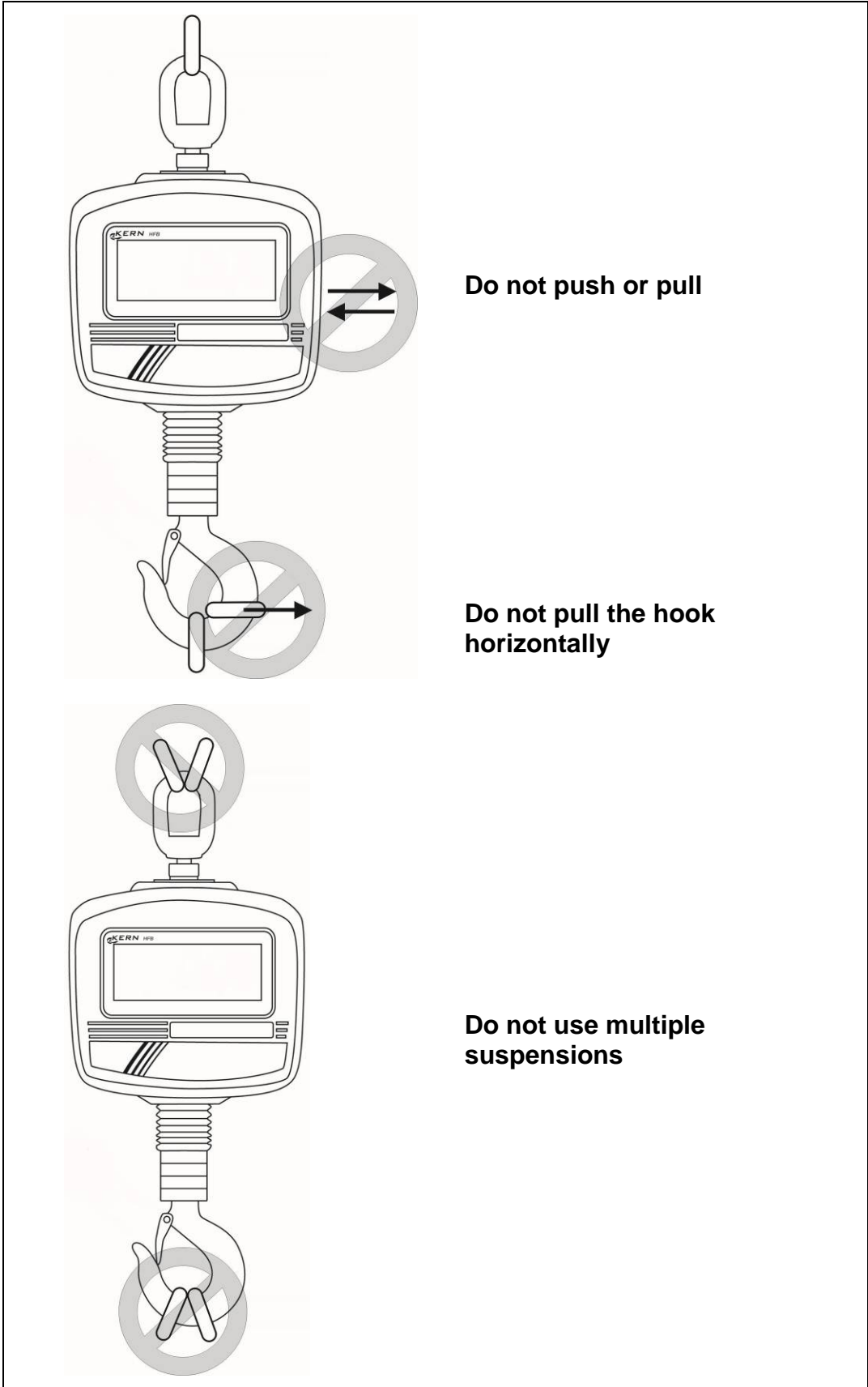

5.3 Turn on/off

Start-up

- ⇒ Press the **ON/OFF** button on the balance keyboard. The display lights up and the balance carries out a selftest. The selftest is completed when the weight value 0 appears on the display.

i Switch on only possible at the keyboard of the balance.

Switching Off

- ⇒ Press the **ON/OFF** button on the balance keyboard.

5.4 Setting the balance to zero

In order to obtain optimal weighing results, reset to zero the balance before weighing. Further adjustments are possible in the menu, see chapter 6.

Manual

- ⇒ Unload the balance
- ⇒ Press the **ZERO** button, the balance begins to reset to zero. The [▼] symbol over a appears.

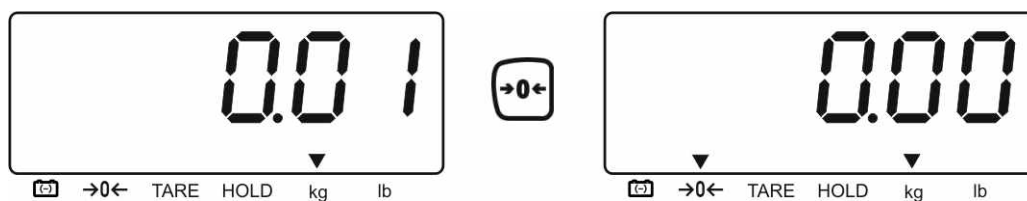

Automatic

In the menu can be changed the amount of the automatic zero point correction, see chap. 6 / Function „F3 a2n“.

5.5 Taring

⇒ Suspend preload.

Press the **TARE** button, the zero display and the [▼] symbol above **TARE** will appear. The weight of the container is now internally saved.

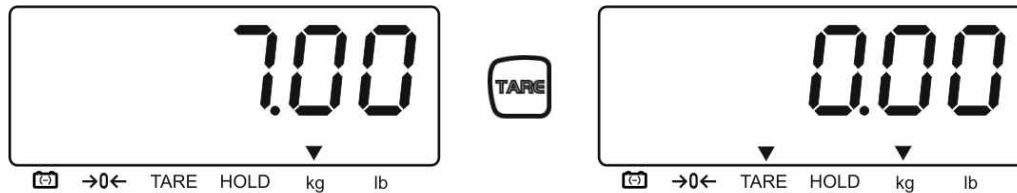

⇒ Weigh the material, the net weight will be indicated.

⇒ After removing the preload weight appears as negative display.

⇒ To delete the tare value, remove load from crane scales and press the **TARE** button.

5.6 Weighing

⇒ Load the crane scales.

The weight value will be displayed at once.

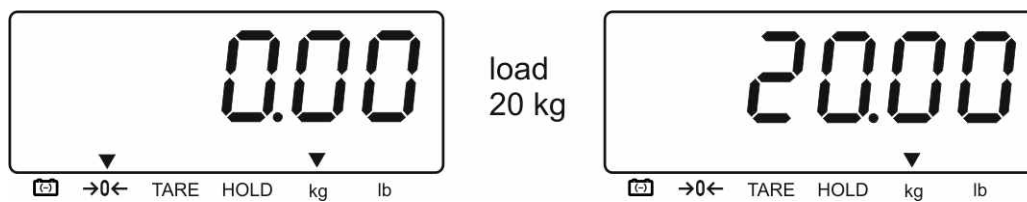

i Overload warning

Overloading exceeding the stated maximum load (max) of the balance, minus a possibly existing tare load, must be strictly avoided.

This could cause damage to the balance.

Exceeding the maximum load is indicated by the display „--ol-“.

Unload balance or reduce preload.

5.7 Record weight value (freeze)

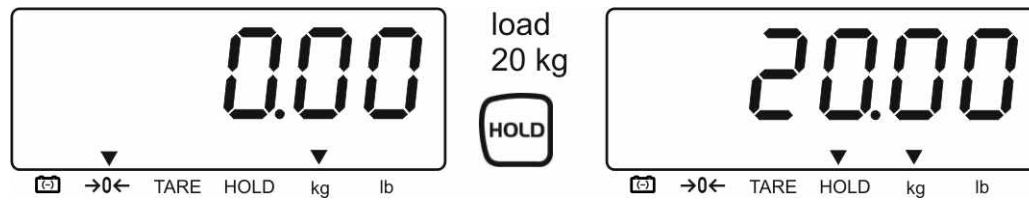

- ⇒ Press the **HOLD** button to „freeze“ or to record the current weight value. It remains displayed until it is deleted. The [▼] symbol above **HOLD** appears.
- ⇒ In order to delete the "frozen" or the recorded weight, press the **HOLD** button. The [▼] symbol above **HOLD** extinguishes.

6. Menu

Navigation in the menu:

Call function	⇒ Switch-on balance and during the selftest press the TARE button. The first function FOCAP is displayed.
Select function	⇒ The TARE button allows to select the individual functions one after the other.
Select setting	⇒ Confirm the selected function by the ZERO button. The current setting will be displayed.
Change settings	⇒ Use the TARE button to switch over into the available settings.
Confirm setting	⇒ Press down and hold the ZERO button, the balance returns to the menu
Exit menu / Return to weighing mode	⇒ Press the UNIT button.

Overview:

Function	Available settings	Description	
F0 CAP Select capacity	30k 60k 150k 300k 600k	Max = 30 kg Max = 60 kg Max = 150 kg Default setting HFB 150K50 Max = 300 kg Default setting HFB 300K100 Max = 600 kg Default setting HFB 600K200	Modifications may only be carried out by a specialist with competent knowledge.
F1 unit	Not documented		
F2 res Select resolution	inC 5* inC 10	5 10	
F3 a2n Automatic zero point correction (zero tracking)	0.5 d 1 d* 2 d 4 d	0.5 d 1 d 2 d 4 d	
F4 Flt Filter	Flt 1 Flt 2* Flt 3 Flt 4 Flt 5	fast ↕ slow	
F5 inP	Internal A/D converter value		
F6 bk Display background illumination	bk Au bk of bk on	Background illumination switches on automatically when loaded or a button is pressed Background illumination off Background illumination on	
F7 off Automatic shutdown function	of 0 of 3 of 5 of 10 of 20	Balance will switch-off automatically after the set period. Selectable 0/3/5/15/20 minutes.	
F8 Grv	Not documented		
F9 CAL	Adjustment, see chapt. 7		

* = default setting

7. Adjustment

- ⇒ Switch-off balance and attach a carrying help if necessary.
- ⇒ Switch-on balance with attached carrying help and during the selftest press the **TARE** button. The first function “**F0CAP**” is displayed.



- ⇒ Press the **TARE** button repeatedly until „**F9 CAL**“ will be displayed.



- ⇒ Press the **ZERO** button, „UnLD“ is displayed.
- ⇒ Unload the balance, wait until the [▼] symbol above **HOLD** appears.



- ⇒ Press the **ZERO** button, the currently set adjustment weight is displayed.
- ⇒ In order to change, select the number to be changed by the **HOLD** button and set the desired value using the **TARE** button, the active digit flashes.
- ⇒ Confirm by the **ZERO** button, „LoAd“ will be displayed.
- ⇒ Attach the adjustment weight and wait until the [▼] symbol above **HOLD** appears



- ⇒ Press the **ZERO** button.

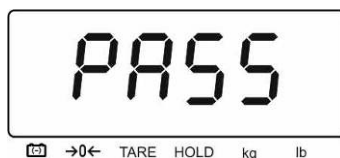

- ⇒ After successful adjustment the balance carries out a selftest, then it automatically returns to weighing mode.
An adjusting error or incorrect adjusting weight will be indicated by the error message; repeat adjustment procedure

8. Error messages

Error message	Description	Possible causes
--ol-	Maximum load exceeded	⇒ Reduce load ⇒ Check whether the balance has been damaged
Err 4	Zeroing range exceeded (normally 4% max)	⇒ Overload when zeroing
Err 5	Keyboard error	⇒ Improper operation of the balance
Err 6	Value outside the A/D changer range	⇒ Weighing plate not installed ⇒ Damaged weighing cell ⇒ Damaged electronics
Err 9	At an instable weighing value ZERO or TARE button actuated	⇒ Wait for a stable weighing value
Err 17	Tare value out of range	⇒ Reduce tare load
Ba lo	Capacity of rechargeable battery exhausted	⇒ Recharge battery

Should other error messages occur, switch balance off and then on again. If the error message remains, inform manufacturer.

9. Cleaning, Maintenance and Disposal

 <p>Danger</p>	<p>Risk of injury and risk of material damage! The crane scales are part of a hoisting device! For a safe operation please observe the following:</p> <ul style="list-style-type: none"> ⇒ Have carried out a regular maintenance by trained specialized staff ⇒ Carry out regular maintenance and care, see chapter 9.2 and 9.3 ⇒ Have the parts exchanged only by trained specialized staff. ⇒ If there arose discrepancies with the safety checklist, the balance must not more be put into operation. ⇒ Do not repair the crane scales by yourself. Repair may only be carried out by service partners authorized by Messrs. KERN.
--	--

9.1 Cleaning and Disposal

 <p>CAUTION</p>	<p>Damage on the crane scales!</p> <ul style="list-style-type: none"> ⇒ Do not use any industrial solutions or chemicals
--	--

- ⇒ Clean the keyboard and the display with a soft cloth soaked in mild window cleaning agent.
- ⇒ Disposal of packaging and appliance must be carried out by operator according to valid national or regional law of the location where the appliance is used.

9.2 Regular maintenance and care

- ▲ The regular 3-month maintenance may only be carried out by an expert with competent knowledge of working with crane scales. Thereby the national regulations for prevention of accidents as well as the working, operation and safety regulations of the owner-operator must be observed.
- ▲ To check the dimensions only use suitable test devices.
- ▲ The regular 12-month maintenance must only be carried out by trained specialized staff (KERN customer service).
- ▲ The results of the maintenance must be written down in the checklist (chap. 9.3).
- ▲ The additional results of the extended maintenance have to be entered in the checklist (chapter 10.1).
- ▲ The replaced spare parts also must be entered, (chapter 10.2)

Regular maintenance:

Prior to each usage

- Check the firm fit of the nut (A) and safety disk (B).



English

<p>Initial Commissioning, every 3 months or anyway after 12 500 weighings</p>	<ul style="list-style-type: none"> ▪ Check all dimensions, see checklist chap. 9.3 ▪ Check the application of the safety bracket on the hook, moreover check for fault and correct function ▪ Check the stable fit of the eyelet. ▪ Visual check of chain for damage and corrosion. ▪ Check the chain and the eyelet for wear and tear, such as e.g. plastic deformation, mechanical damage (unevenness), notches, striation, cracks, corrosion, thread damage and torsions. <p>If a dimension exceeds the admitted deviation from the original dimension (see checklist, chap. 9.3) or if other discrepancies have been found, the balance must be repaired at once by trained specialized staff (KERN customer service). Never do repair it by yourself! Take balance out of operation immediately!</p> <p>All repairs and spare parts must be documented by the service partner (see list, chap. 10.2).</p>		
<p>Every 12 months or in any case after 50 000 weighings</p>	<ul style="list-style-type: none"> ▪ If the enhanced maintenance has to be carried out by trained staff (KERN customer service). At this general revision all load carrying parts must be checked for gaps with magnetic powder 		
	<p>Components</p>	<p>Testing</p>	<p>Position</p>
	<ul style="list-style-type: none"> ▪ Lock washers 	<p>Check for tight fit and for damage</p>	<p>①</p>
	<ul style="list-style-type: none"> ▪ Bolt 		
	<ul style="list-style-type: none"> ▪ Splint 	<p>Check for tight fit and if deformed</p>	<p>②</p>
	<ul style="list-style-type: none"> ▪ Nut 		<p>③</p>
	<ul style="list-style-type: none"> ▪ Lock washers 		<p>⑥</p>
	<ul style="list-style-type: none"> ▪ Chain 	<p>Visual check for damage and corrosion</p>	<p>④</p>
	<ul style="list-style-type: none"> ▪ Safety bracket 	<p>Visual check for damage and corrosion</p>	<p>⑤</p>

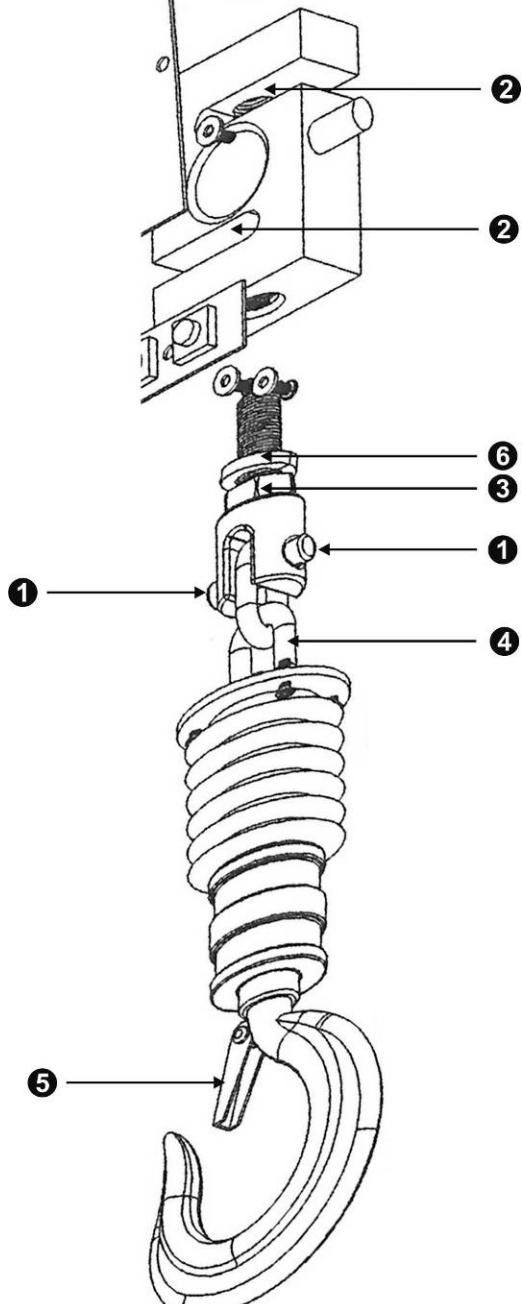
	 <p>All inspections must be registered in the checklist (chap. 9.4).</p>
<p>Every 5 years or anyway after 250 000 weighings</p>	<ul style="list-style-type: none"> ▪ All load carrying parts have to be exchanged by trained specialized staff (KERN customer service).
<p>Every 10 years or anyway after 500 000 weighings</p>	<ul style="list-style-type: none"> ▪ Replace the crane scales entirely

Note
 During the revision watch out for wear and tear according to the following drawings (chap. 9.3).

9.3 Checklist „regular maintenance“, (see chapter 9.2)

Original dimensions crane scales, serial no.: Capacity					
Eyelet		Hooks			
a (mm)	b (mm)	Wear and tear	c (mm)	d (mm)	Angle α (°)
Date Tester					

These data can be found in the document attached to the balance. Please keep this document always available.

	Eyelet			Hooks					Chain		
	a	b	Wear and tear (see grey fields)	c	d	Angle α	Wear and tear (see grey fields)	Safety bracket 5	No damage or corrosion (see grey fields)	Date	Tester
Max. admitted variation	5 %	0 %	No deformation or cracks	10 %	5 %	10 °	No deformation or cracks	Perfect working order			
Revision prior to first use											
3 months / 12 500 x											
6 months / 25 000 x											
9 months / 37500 x											
12 months/ 50 000 x											
15 months / 62 500 x											
18 months / 75 000 x											
21 months / 87 500 x											

	Eyelet			Hooks					Chain	Date	Tester
	a	b	Wear and tear (see grey fields)	c	d	Angle α	Wear and tear (see grey fields)	Safety bracket 5	No damage or corrosion (see grey fields)		
Max. admitted variation	5 %	0 %	No deformation or cracks	10 %	5 %	10 °	No deformation or cracks	Perfect working order			
Revision prior to first use											
24 months / 100 000 x											
27 months/ 112 500 x											
30 months/ 125 000 x											
33 months/ 137 500 x											
36 months/150000 x											
39 months /162 500 x											
42 months /175 000 x											
45 months /187 500 x											
48 months/200000 x											
51 months /212 500 x											
54 months /225 000 x											
57 months /237 500 x											
60 months/250000x	➔ All load carrying parts have to be exchanged by a service partner authorised by KERN.										

bold letters = this maintenance work has to be carried out by a service partner authorized by KERN.

Eyelet and hook

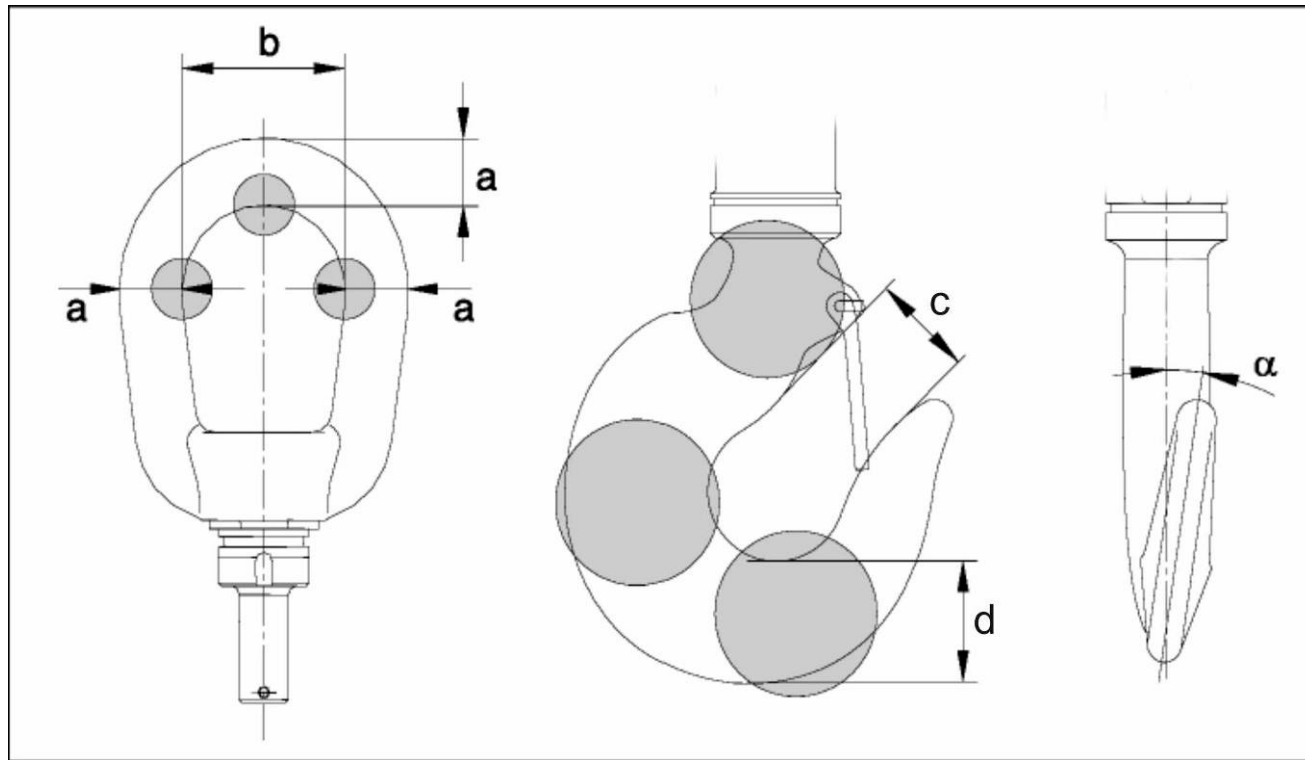

Chain

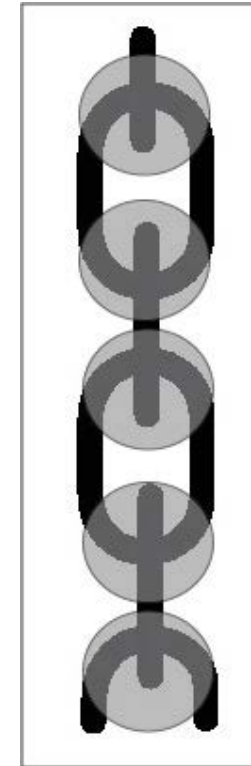

9.4 12-month maintenance (see chap. 9.2)

	①		②	③	⑥	④	⑤		Date	Tester
	Tight fit / damage		Tight fit / deformation			Visual check for damage / corrosion				
	Lock washers	Bolt	Split pin	Nut	Lock washers	Chain	Safety bracket			
12 months / 50 000 x										
24 months / 100 000 x										
36 months / 150 000 x										
48 months / 200 000 x										
60 months / 250 000x	➔ All load carrying parts have to be exchanged by a service partner authorised by KERN.									

10. Appendix

10.1 Checklist „Enhanced maintenance“ (General revision)

The enhanced maintenance has to be carried out by a service partner authorized by KERN.

Crane scales		Model Serial no.					
Interval	Magnetic powder test for cracks	Hooks	Eyelet	Screwed connections	Date	Name	Signature
12 months / 50 000 x							
24 months / 100 000 x							
36 months / 150 000 x							
48 months / 200 000 x							
60 months / 250 000 x							
72 months / 300 000 x							
84 months / 350 000 x							
96 months / 400 000 x							
108 months / 450 000 x							
120 months/500 000x	➔ Replace crane scales entirely						

