



**KERN & Sohn GmbH**

Ziegelei 1  
D-72336 Balingen  
email: [info@kern-sohn.com](mailto:info@kern-sohn.com)

Phone: +49-[0]7433- 9933-0  
Fax: +49-[0]7433-9933-149  
Internet: [www.kern-sohn.com](http://www.kern-sohn.com)

## Operating instructions Electronic Crane Scales

Logbook  
Regular maintenance and care

### **KERN HFM**

Version 1.1  
09/2010  
GB



HFM-BA-e-1011



# KERN HFM

Version 1.1 09/2010

## Operating instructions / logbook Electronic Suspending Balance

### Table of Contents

|            |  |           |
|------------|--|-----------|
| <b>1.</b>  | <b>Technical Data</b>                                  | <b>3</b>  |
| 1.1        | Dimensions (mm)  | 4         |
| <b>2.</b>  | <b>General Safety Instructions</b>                     | <b>5</b>  |
| <b>3.</b>  | <b>The crane scales at a glance</b>                    | <b>8</b>  |
| 3.1        | Overview   | 8         |
| 3.2        | Display  | 9         |
| 3.3        | Keyboard   | 9         |
| 3.3.1      | Numeric entry  | 10        |
| 3.4        | Radio remote control                                   | 10        |
| 3.5        | Sticker  | 11        |
| <b>4.</b>  | <b>Commissioning</b>                                   | <b>12</b> |
| 4.1        | Unpacking  | 12        |
| 4.2        | Checking the original dimensions                       | 12        |
| 4.3        | Rechargeable battery operation                         | 13        |
| 4.3.1      | Standby mode   | 13        |
| 4.4        | Suspending the balance                                 | 14        |
| <b>5.</b>  | <b>Operation</b>                                       | <b>15</b> |
| 5.1        | Safety instructions                                    | 15        |
| 5.2        | Loading the crane scales                               | 16        |
| 5.3        | Turn on/off  | 19        |
| 5.4        | Setting balance to zero                                | 19        |
| 5.5        | Taring   | 20        |
| 5.6        | Weighing   | 20        |
| 5.7        | Record weight value (freeze)                           | 20        |
| <b>6.</b>  | <b>Menu</b>  | <b>21</b> |
| <b>7.</b>  | <b>Adjustment</b>                                      | <b>23</b> |
| <b>8.</b>  | <b>Error messages</b>                                  | <b>24</b> |
| <b>9.</b>  | <b>Cleaning, Maintenance and Disposal</b>              | <b>25</b> |
| 9.1        | Cleaning and Disposal                                  | 25        |
| 9.2        | Regular maintenance and care                           | 25        |
| 9.3        | Checklist „Regular maintenance“, (see chapter 9.2)     | 27        |
| <b>10.</b> | <b>Appendix</b>  | <b>30</b> |
| 10.1       | Checklist „Enhanced maintenance“ (General revision)    | 30        |
| 10.2       | List „spare parts and repair of safety-relevant parts“ | 31        |

## 1. Technical Data

| KERN   | HFM 1T0.1  | HFM 3T0.5       | HFM 5T0.5 | HFM 10T1  |
|--|--|-----------------|-----------|-----------|
| Readability (d)                                  | 0.1 kg   | 0.5 kg          | 0.5 kg    | 1 kg      |
| Weighing range (max)                             | 1 000 kg   | 3 000 kg        | 5 000 kg  | 10 000 kg |
| Taring range (subtractive)                       | 1 000 kg   | 3 000 kg        | 5 000 kg  | 10 000 kg |
| Reproducibility                                  | 500 g  | 1 kg            | 2.5 kg    | 5 kg      |
| Linearity  | ±1 kg  | ±2 kg           | ±5 kg     | ±10 kg    |
| Recommended adjustment weight, not added (class) | 1 t (M1)   | 3 t (M1)        | 5 t (M1)  | 10 t (M1) |
| Stabilization time                               | 2 s  |                 |           |           |
| Precision  | 0.2 % of max.  |                 |           |           |
| Warm-up time                                     | 30 min   |                 |           |           |
| Unit   | kg   |                 |           |           |
| Allowable ambient temperature                    | 0...+40 °C   |                 |           |           |
| Relative humidity                                | 0 to 80 %, non-condensing                                |                 |           |           |
| Supply voltage                                   | 220V - 240V AC 50 Hz                                     |                 |           |           |
| Secondary voltage powerpack                      | 9V, 800 mA   |                 |           |           |
| Rechargeable battery (standard equipment)        | 6 V 1.2 A<br>Service life 60 h<br>Loading time 24 h      |                 |           |           |
| Display  | Digit height 30 mm                                       |                 |           |           |
| Housing size W x D x H, (mm)                     | 270 x 175 x 200  | 300 x 190 x 230 |           |           |
| Housing material                                 | Metal, lacquered   |                 |           |           |
| Material hook and shackle                        | Nickel plated steel                                      |                 |           |           |
| Net weight (kg)                                  | 16   | 18              | 23        | 35        |
| Remote control (standard equipment)              | Battery Size 23A (1 x 1.5V)<br>W x D x H 48 x 16 x 95 mm |                 |           |           |

### 1.1 Dimensions (mm)

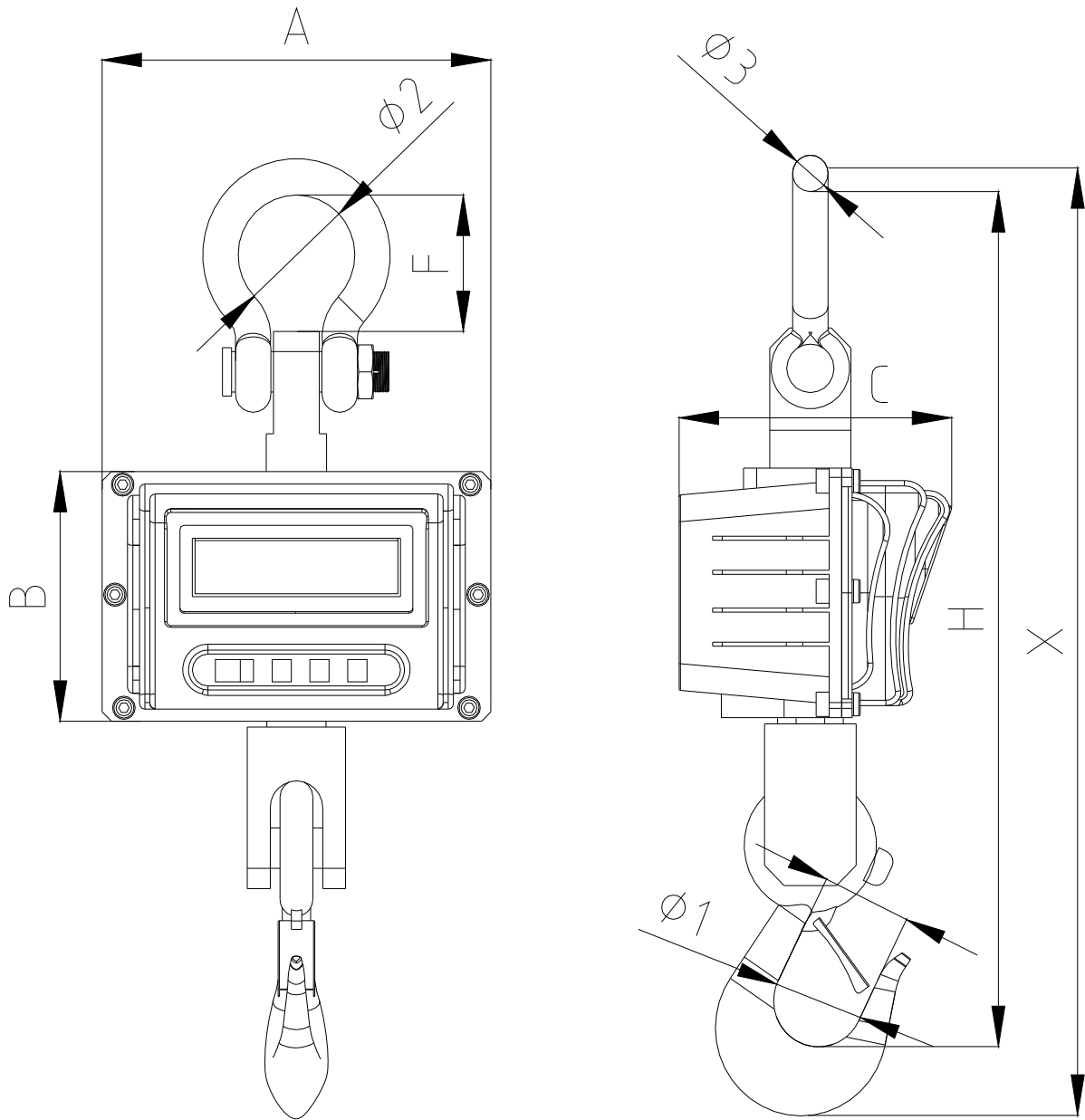

|           | <b>A</b> | <b>B</b> | <b>C</b> | <b>D</b> | <b>F</b> | <b>H</b> | <b>Ø 1</b> | <b>Ø 2</b> | <b>Ø 3</b> | <b>X</b> |
|-----------|----------|----------|----------|----------|----------|----------|------------|------------|------------|----------|
| HFM 1T0.1 | 270      | 173      | 200      | 40       | 98       | 285      | 51         | 68         | 25         | 540      |
| HFM 3T0.5 | 270      | 173      | 200      | 40       | 95       | 540      | 63.5       | 74         | 29         | 610      |
| HFM 5T0.5 | 297      | 185      | 230      | 55       | 95       | 635      | 63.5       | 74         | 29         | 700      |
| HFM 10T1  | 297      | 185      | 230      | 60       | 110      | 750      | 76.2       | 92         | 35         | 840      |

## 2. General Safety Instructions

### Duties of the owner-operator

Follow the national accident prevention regulations as well as the working, operating and safety regulations of the owner-operator.

- Observe all safety regulations of the crane manufacturer.
- The balance may only be used for the proposed purpose. Any type of use which is not specified in these operating instructions, will be considered as improper use. The customer is solely responsible for material damage and injury of persons resulting from an improper use, Messrs. KERN & Sohn will not be liable under any circumstance.

Messrs. KERN & Sohn cannot be held liable, if the crane scales are modified or used improperly and if damage is resulting from such use.

- Carry out regular maintenance and care of the crane scales, the crane and the load suspension devices (see chapter 9).
- Log the test result and keep it in the logbook.

### Organizational measures

- Only trained and instructed staff may operate the balance.
- Make sure that the operating instructions are kept nearby the operation site of the crane scales.
- Assembly, commissioning and maintenance should only be carried out by trained specialists.
- Repair of safety-relevant pieces may only be carried out by KERN or by service partners authorized by Messrs. KERN. (competence certificate or training).
- Use original spare parts only.
- All repairs and spare parts must be documented by the service partner (see list, chap. 10.3).
- All maintenance must be documented (see checklist chap. 9.3).
- Load suspending components may only be exchanged as a complete spare parts set. The dimensions of the new components must be noted (see checklist chapter 9.3).

### Ambient conditions

- Never operate the crane scales in explosive environment. The serial version is not explosion protected.
- Operate the crane scales only under environmental conditions as specified in these operating instructions (especially in chapter 1 „Technical data“).
- Do not expose the crane scales to strong humidity. Non-permitted condensation (condensation of air humidity on the appliance) may occur if a cold appliance is taken to a considerably warmer environment. In this case, acclimatize the disconnected appliance for ca. 2 hours at room temperature.
- Do not operate the crane scales in corrosive environment.
- Protect the crane scales against high humidity, vapours and dust.

- Major display deviations (incorrect weighing results) may be experienced should electromagnetic fields (e.g. due to mobile phones or radio equipment), static electricity accumulations or instable power supply occur. Change location or remove source of interference.

### **Proper use**

The balance you purchased is intended to determine the weighing value of material to be weighed. It is intended to be used as a “non-automatic“ balance, i.e. the material to be weighed is suspended on the crane hook only vertically, manually, carefully and without jerks. As soon as a stable weighing value is reached the weighing value can be read.

- Use the crane scales only for lifting and weighing of freely movable loads.
- Danger of injury due to improper use. Not allowed are e.g.:
  - Exceeding the allowed nominal load of crane, crane scales or any type of load attachment devices
  - Conveying persons,
  - Pulling loads over an inclined surface,
  - Tearing-off, pulling or towing loads.
- Modifications or reconstructions of the crane scales or of the crane are not allowed.

### **Improper Use**

Do not use balance for dynamic weighing. In the event that small quantities are removed or added to the material to be weighed, incorrect weighing results can be displayed due to the “stability compensation“ in the balance. (Example: Slowly draining fluids from a container suspended on the balance.) Do not leave permanent load suspended on the balance. This may damage the measuring system as well as safety-relevant parts.

The balance may only be used according to the described conditions. Other areas of use must be released by KERN in writing.

### **Warranty**

Warranty claims shall be voided in case

- Our conditions in the operation manual are ignored
- The appliance is used outside the described use
- The appliance is modified or opened
- Mechanical damage and damage caused by media, liquids,
- Natural wear and tear
- The appliance is improperly set up or incorrectly electrically connected
- The measuring system is overloaded

### **Safe working**

- Do not stand underneath suspended loads!
- Position the crane in a way that the load is lifted vertically.
- When working with the crane and crane scales wear personal safety equipment (helmet, safety shoes etc.).

### **Monitoring of Test Resources**

In the framework of quality assurance the measuring-related properties of the balance and, if applicable, the testing weight, must be checked regularly. The responsible user must define a suitable interval as well as type and scope of this test. Information is available on KERN's home page ([www.kern-sohn.com](http://www.kern-sohn.com)) with regard to the monitoring of balance test substances and the test weights required for this. In KERN's accredited DKD calibration laboratory test weights and balances may be calibrated (return to the national standard) fast and at moderate cost.

### **Testing upon acceptance**

When receiving the appliance, please check packaging immediately, and the appliance itself when unpacking for possible visible damage.

### **Initial Commissioning**

In order to obtain exact results with the electronic balances, your balance must have reached the operating temperature (see warming up time chap. 1).

During this warming up time the balance must be connected to the power supply (mains, accumulator or battery).

The accuracy of the balance depends on the local acceleration of gravity.

Strictly observe hints in chapter Adjustment.

Check the original dimensions, see chap. 4.2.

### **Shutdown and storage**

- Take off the crane scales from the crane and dismantle all load attachment devices from the crane scales.
- Do not store the crane scales at open air

### 3. The crane scales at a glance

The crane scales are a multi-purpose and cost-saving solution for overhead weighing applications such as e.g. recycling, metal processing, machine engineering, transport and logistics.

With the radio remote control, operation will be more comfortable yet.

#### 3.1 Overview



Fig. 1: Front view of balance

- 1 Shackle
- 2 Display
- 3 Keyboard
- 4 Safety bracket
- 5 Hook, revolvable



Fig. 2: Radio remote control

- 6 Antenna
- 7 Keyboard,  
see chapter 3.5



### 3.2 Display



|            |   |
|------------|---|
| <b>LED</b> | <b>The LED lights up, if</b>                    |
|            | the weight display is stable                    |
| <b>→0←</b> | the weight is in the area around the zero point |
|            | when the battery is being recharged             |

### 3.3 Keyboard



| Button          | Description of function  |
|-----------------|--|
| <b>ON/OFF</b>   | <ul style="list-style-type: none"> <li>Turn on or off the balance</li> </ul>   |
| d= 1/2/5 kg<br> | <ul style="list-style-type: none"> <li>Modification of readability               <ul style="list-style-type: none"> <li><b>HFM 1T0.1: 100g⇒200g⇒500g</b></li> <li><b>HFM 3T0.5: 500g⇒ 1 kg⇒2 kg</b></li> <li><b>HFM 5T0.5: 500g⇒ 1 kg⇒2 kg</b></li> <li><b>HFM 10T1: 1 kg ⇒ 2 kg⇒5 kg</b></li> </ul> </li> <li>Scroll forward in menu</li> </ul> |
| <b>HOLD</b>     | <ul style="list-style-type: none"> <li>Record weight value (freeze)</li> <li>Exit menu</li> </ul>  |
| <b>→0←</b>      | <ul style="list-style-type: none"> <li>Taring</li> <li>Zeroing</li> <li>Confirm entry</li> </ul>   |

### 3.3.1 Numeric entry

| Button           | Function                |
|------------------|-------------------------|
| d= 1/2/5 kg<br>↔ | Increase flashing digit |
| <b>HOLD</b>      | Digit selection         |
| →0←              | Terminate input         |

### 3.4 Radio remote control

The balance can be operated by the radio remote control like by a keyboard. All functions (excepted **ON/OFF**) can be selected.

The red LED must light up when any button is pressed. If it does not light up, the batteries in the remote control must be exchanged.

Range on free surface (free of buildings) approx. 20 m.

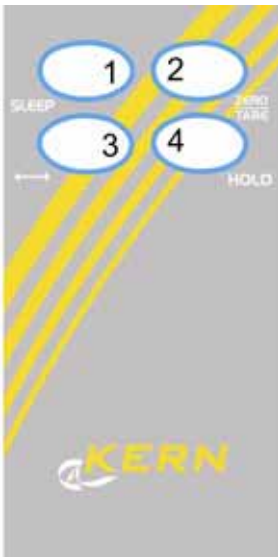
|  |   |                                  |
|--|---|----------------------------------|
|  | 1 | Standby-Modus, see chapter 4.3.1 |
|  | 2 | Zeroing / Taring                 |
|  | 3 | Modification of readability      |
|  | 4 | Record weight value (freeze)     |

### 3.5 Sticker



- ⇒ Do not stand or go under suspended loads.
- ⇒ Do not use on building sites.
- ⇒ Suspended loads have to be observed constantly.



- ⇒ Do not exceed the nominal load of crane scales.

(Example)





- ⇒ The product meets the requirements of the German Equipment and Product Safety Act.

## 4. Commissioning

**Attention:** Always observe chapter 2 „General Safety Instructions“!

### 4.1 Unpacking

|   |  |
|---|--|
|  <p><b>SAFETY</b><br/><b>INSTRUCTIONS</b><br/>for protection against<br/>break</p> | <p><b>Once delivered and unpacked, crane scales will not be taken back.</b></p> <p>The crane scales have been sealed by Messrs. KERN.</p> <ul style="list-style-type: none"> <li>⇒ Shackles and hooks are sealed by Sella tape.</li> <li>⇒ The packaging is also sealed by adhesive tape.</li> </ul> <p> <b>Broken seal obliges to purchase.</b></p> <p>Thanks for your comprehension.<br/>Your KERN Quality assurance team</p> |
|  <p><b>CAUTION</b><br/>Danger for the back!</p>                                    | <p><b>The crane scales are compact and quite heavy.</b></p> <ul style="list-style-type: none"> <li>⇒ Remove the scales from packaging only with the help of a second person.</li> <li>⇒ Use a lifting device such as a crane or a forklift truck.</li> <li>⇒ Secure the scales that they cannot fall down when they are lifted.</li> </ul>   |

- ⇒ Make sure that all parts are completely present.
  - Crane scales
  - Mains adapter
  - Remote control
  - Operating instructions (logbook)

Only use original packaging for returning.

### 4.2 Checking the original dimensions

- ⇒ Enter the original dimensions of the product datasheet into the grey fields of the checklist chap. 9.3.
- ⇒ Realisation of all safety checks, see chapter 9.2 „Regular maintenance after three months“
- ⇒ Enter all data (date, tester, results) in the first line under „Inspection before first use“ in the checklist (see chapter 9.3)

|   |  |
|---|--|
|  <p><b>CAUTION</b></p> | <p>If the dimensions of your first safety inspection do not match those of KERN, the balance must not be put into operation. In this case please contact a service partner authorised by Messrs. KERN.</p> |
|---|--|

## 4.3 Rechargeable battery operation

|   |   |
|---|---|
| <br><b>CAUTION</b> | <b>Material damage on crane scales</b> <ul style="list-style-type: none"><li>⇒ Only use the delivered mains adapter.</li><li>⇒ Make sure that the mains adapter, the cable and the mains plug are in a perfect condition.</li><li>⇒ Do not use the crane scales during the loading process.</li></ul> |
|---|---|

Before the first use, the rechargeable battery should be charged by connecting it to the mains power cable for at least 24 hours. The operating time of the rechargeable battery is approx. 60 hours.

The capacity of the rechargeable battery will soon be exhausted, when the display begins to flicker. If „bat lo“ appears, the balance will remain operable for approx. 30 minutes more, then it switches off automatically. Connect the power cable as soon as possible to load the rechargeable battery.

During loading the LED display above  informs you about the loading status of the rechargeable battery.

red: Voltage has dropped below prescribed minimum.

green: Rechargeable battery is completely charged

yellow: Capacity of rechargeable battery almost exhausted

When the crane scales are out of operation for a longer period, remove the rechargeable battery.

### 4.3.1 Standby mode

The crane scales change into the standby mode when any key is pressed or when for 5 minutes (factory setting) no weight change has been measured. Only one segment remains lighting. In order to finish the standby mode, press any key on the keyboard or on the remote control.

Switch-off time selectable after 0, 5, 10, 20, 30 minutes, see chap. „F6 sl“.

#### 4.4 Suspending the balance

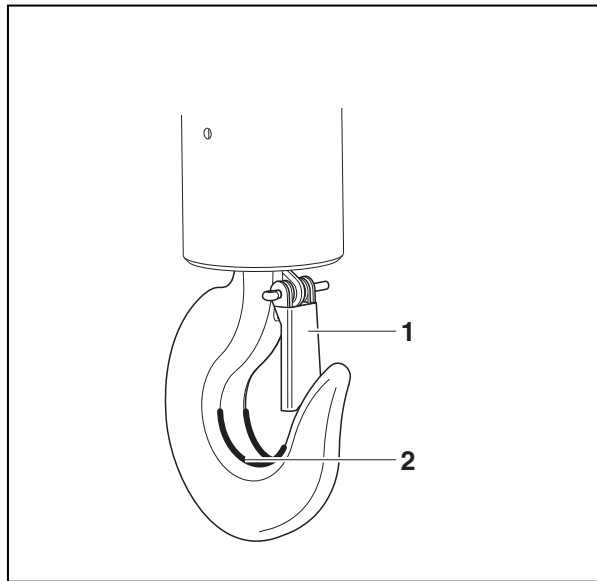

#### Condition





The crane needs a safety bracket (1) that the unloaded crane scales cannot fall down.

If the safety bracket is missing or damaged, please contact the crane manufacturer in order to receive a hook with this safety equipment.

- ⇒ Suspend the crane scales on the lower hook of a crane and close the safety bracket.  
The crane scale's upper eyelet should rest in the saddle (2).

## 5. Operation

### 5.1 Safety instructions

|  |  |
|--|--|
|   |  <p><b>Risk of injury due to falling loads!</b><br/><b>DANGER</b></p>   |
|   <p>(Example)</p> | <ul style="list-style-type: none"> <li>⇒ Always work with particular care according to the general rules for crane operation.</li> <li>⇒ Check all parts (hook, eyelet, rings, rope slings, cables, chains etc.) for excessive wear or damage</li> <li>⇒ If faults can be seen on the safety bracket of the hook or if it is missing completely, the scales must not be used.</li> <li>⇒ Work only with appropriate speed.</li> <li>⇒ Always avoid vibrations and horizontal forces. Avoid any kind of shock, torsion and oscillating (e.g. caused by inclined suspending).</li> <li>⇒ Do not use the crane scales for transport of loads</li> <li>⇒ Do not stand or go under suspended loads.</li> <li>⇒ Do not use on building sites.</li> <li>⇒ Suspended loads have to be observed constantly.</li> <li>⇒ Do not exceed the nominal load of crane, crane scales or any kind of load attachment devices at the crane scales.</li> </ul> |

## 5.2 Loading the crane scales

For good weighing results observe the following, illustrations see next page:

- ⇒ Only use load attachment devices which guarantee a one-spot suspension and where the scales can be suspended freely.
- ⇒ Do not use too large load attachment devices which do not guarantee any one-spot suspension.
- ⇒ Do not use multiple suspensions.
- ⇒ Do not pull or push the load or the loaded balance.
- ⇒ Do not pull the hook horizontally.

### Loading the balance

1. Position the hook of the crane scales over the load.
2. Move downwards the crane scales until the load can be suspended on the hook of the balance. Reduce the speed when the respective height is going to be reached.
3. Suspend the load on the hook. Ensure that the safety bracket is closed. If the load is fixed by slings, ensure that the slings rest completely on the saddle of the balance hook.
4. Lift-off the load slowly.

When the load is fixed by slings, ensure that the load is well balanced on both sides and that the slings are correctly positioned



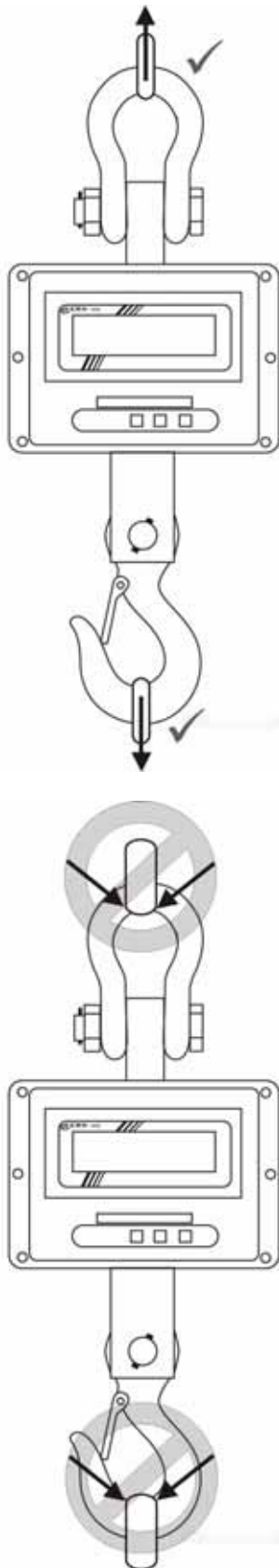

**Only use load attachment devices which guarantee a one-point suspension and where the scales can be suspended freely.**

**Do not use too large load attachment devices which cannot guarantee a one-point suspension.**

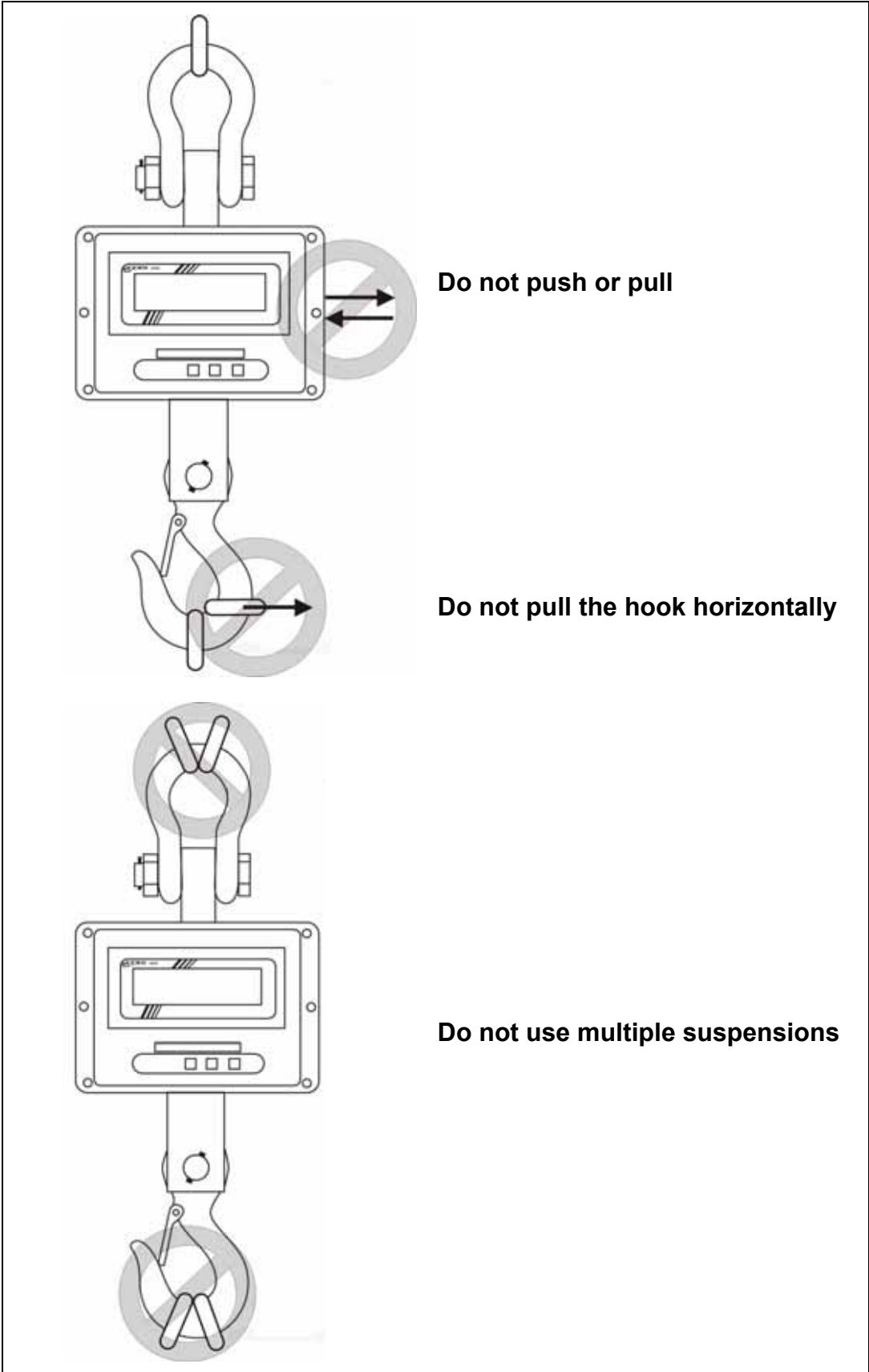

## 5.3 Turn on/off

### Start-up

- ⇒ Press the **ON/OFF** button on the balance keyboard. The display lights up and the balance carries out a selftest. The selftest is completed when the weight value 0 appears on the display.



Switch on only possible at the keyboard of the balance.

### Switching Off

- ⇒ Press the **ON/OFF** button on the balance keyboard.

## 5.4 Setting balance to zero

In order to obtain optimal weighing results, reset to zero the balance before weighing.

### Manual

- ⇒ Unload the balance
- ⇒ Press the **ZERO** button.  
In the display appears 0 (kg) and the **LED** a lights up.

### Automatic

In the menu the amount of the automatic zero point correction can be changed, see chapter 6 / Function „F1 az“.

## 5.5 Taring

- ⇒ Suspend preload.  
Press the **ZERO** button. In the display appears 0 (kg) and the **LED →0←** lights up. The weight of the container is now internally saved.
- ⇒ Weigh the material, the net weight will be indicated.
- ⇒ After removing the preload weight appears as negative display.
- ⇒ To delete the tare value, remove load from crane scales and press the **ZERO** button.

## 5.6 Weighing

- ⇒ Load the crane scales.  
The weight value will be displayed at once. After standstill control the **LED ▽/△** lights up.



### Overload warning

Overloading exceeding the stated maximum load (max) of the balance, minus a possibly existing tare load, must be strictly avoided. This could cause damage to the balance.

Exceeding the maximum load is indicated by the display „--ol-“. Unload balance or reduce preload.

## 5.7 Record weight value (freeze)

- ⇒ Press the **HOLD** button to „freeze“ or to record the current weight value. It remains displayed until it is deleted. The **LED HOLD** lights up
- ⇒ In order to delete the "frozen" or the recorded weight, press the **HOLD** button. The **LED HOLD** extinguishes.

## 6. Menu

### Navigation in the menu:

|   |  |
|---|--|
| <p><b>Call function</b></p>                       | <p>⇒ Switch on the balance and during the selftest press the <b>ZERO</b> and the <math>d= 1/2/5 \text{ kg}</math> button at the same time. „P1 - - -“ is displayed.</p> <p>⇒ Enter password:</p> <p><b>or</b><br/>select standard password „0000“ with <b>HOLD</b> number, increase the flashing number using <math>d= 1/2/5 \text{ kg}</math></p> <p><b>or</b><br/>personal password, see function F8 ci</p> <p>⇒ Confirm with <b>ZERO</b> button.<br/>The first function „F0 di“ is displayed.</p> |
| <p><b>Select function</b></p>                     | <p>⇒ The <math>d= 1/2/5 \text{ kg}</math> button allows to select the individual functions one after the other.</p>  |
| <p><b>Select setting</b></p>                      | <p>⇒ Confirm the selected function by the <b>ZERO</b> button. The current setting will be displayed.</p>   |
| <p><b>Change settings</b></p>                     | <p>⇒ Use the <math>d= 1/2/5 \text{ kg}</math> button to switch over into the available settings.</p>   |
| <p><b>Confirm setting</b></p>                     | <p>⇒ Press the <b>ZERO</b> button, the balance returns into the menu.</p>  |
| <p><b>Exit menu / Return to weighing mode</b></p> | <p>⇒ Press the <b>HOLD</b> button.</p>   |

Overview:

| Function  | Available settings  | Description  |   |                              |      |      |                              |      |  |  |     |     |     |      |      |      |      |     |      |     |     |     |     |      |     |      |     |     |     |     |      |      |      |      |     |     |     |     |
|---|---|--|---|------------------------------|------|------|------------------------------|------|--|--|-----|-----|-----|------|------|------|------|-----|------|-----|-----|-----|-----|------|-----|------|-----|-----|-----|-----|------|------|------|------|-----|-----|-----|-----|
| F0 di<br>Modification of readability                        | Low   | Modifications may only be carried out by a specialist with competent knowledge.  |   |                              |      |      |                              |      |  |  |     |     |     |      |      |      |      |     |      |     |     |     |     |      |     |      |     |     |     |     |      |      |      |      |     |     |     |     |
|   | High*   |  |   |                              |      |      |                              |      |  |  |     |     |     |      |      |      |      |     |      |     |     |     |     |      |     |      |     |     |     |     |      |      |      |      |     |     |     |     |
|   | cap   |  | <table border="1" style="width: 100%; text-align: center;"> <thead> <tr> <th colspan="3">d (low)<br/>d= 1/2/5 kg<br/>↔</th> <th colspan="4">d (high)<br/>d= 1/2/5 kg<br/>↔</th> </tr> </thead> <tbody> <tr> <td>1 t</td> <td>2kg</td> <td>1kg</td> <td>500g</td> <td>500g</td> <td>200g</td> <td>100g</td> </tr> <tr> <td>3 t</td> <td>10kg</td> <td>5kg</td> <td>2kg</td> <td>2kg</td> <td>1kg</td> <td>500g</td> </tr> <tr> <td>5 t</td> <td>10kg</td> <td>5kg</td> <td>2kg</td> <td>2kg</td> <td>1kg</td> <td>500g</td> </tr> <tr> <td>10 t</td> <td>20kg</td> <td>10kg</td> <td>5kg</td> <td>5kg</td> <td>2kg</td> <td>1kg</td> </tr> </tbody> </table> | d (low)<br>d= 1/2/5 kg<br>↔  |      |      | d (high)<br>d= 1/2/5 kg<br>↔ |      |  |  | 1 t | 2kg | 1kg | 500g | 500g | 200g | 100g | 3 t | 10kg | 5kg | 2kg | 2kg | 1kg | 500g | 5 t | 10kg | 5kg | 2kg | 2kg | 1kg | 500g | 10 t | 20kg | 10kg | 5kg | 5kg | 2kg | 1kg |
|   | d (low)<br>d= 1/2/5 kg<br>↔   |  |   | d (high)<br>d= 1/2/5 kg<br>↔ |      |      |                              |      |  |  |     |     |     |      |      |      |      |     |      |     |     |     |     |      |     |      |     |     |     |     |      |      |      |      |     |     |     |     |
|   | 1 t   |  | 2kg   | 1kg                          | 500g | 500g | 200g                         | 100g |  |  |     |     |     |      |      |      |      |     |      |     |     |     |     |      |     |      |     |     |     |     |      |      |      |      |     |     |     |     |
|   | 3 t   |  | 10kg  | 5kg                          | 2kg  | 2kg  | 1kg                          | 500g |  |  |     |     |     |      |      |      |      |     |      |     |     |     |     |      |     |      |     |     |     |     |      |      |      |      |     |     |     |     |
| 5 t   | 10kg  | 5kg  | 2kg   | 2kg                          | 1kg  | 500g |                              |      |  |  |     |     |     |      |      |      |      |     |      |     |     |     |     |      |     |      |     |     |     |     |      |      |      |      |     |     |     |     |
| 10 t  | 20kg  | 10kg   | 5kg   | 5kg                          | 2kg  | 1kg  |                              |      |  |  |     |     |     |      |      |      |      |     |      |     |     |     |     |      |     |      |     |     |     |     |      |      |      |      |     |     |     |     |
|   |   |  |   |                              |      |      |                              |      |  |  |     |     |     |      |      |      |      |     |      |     |     |     |     |      |     |      |     |     |     |     |      |      |      |      |     |     |     |     |
|   |   |  |   |                              |      |      |                              |      |  |  |     |     |     |      |      |      |      |     |      |     |     |     |     |      |     |      |     |     |     |     |      |      |      |      |     |     |     |     |
| F1 az<br>Automatic zero point correction<br>(zero tracking) | AZn 0<br>AZn 1*<br>AZn 2<br>AZn 3   | 0.5 d<br>1 d<br>2 d<br>4 d   |   |                              |      |      |                              |      |  |  |     |     |     |      |      |      |      |     |      |     |     |     |     |      |     |      |     |     |     |     |      |      |      |      |     |     |     |     |
| F2 bt   | Not documented  |  |   |                              |      |      |                              |      |  |  |     |     |     |      |      |      |      |     |      |     |     |     |     |      |     |      |     |     |     |     |      |      |      |      |     |     |     |     |
| F3 sp   | Not documented  |  |   |                              |      |      |                              |      |  |  |     |     |     |      |      |      |      |     |      |     |     |     |     |      |     |      |     |     |     |     |      |      |      |      |     |     |     |     |
| F4 ip   | Internal A/D converter value  |  |   |                              |      |      |                              |      |  |  |     |     |     |      |      |      |      |     |      |     |     |     |     |      |     |      |     |     |     |     |      |      |      |      |     |     |     |     |
| F5 ut   | Not documented  |  |   |                              |      |      |                              |      |  |  |     |     |     |      |      |      |      |     |      |     |     |     |     |      |     |      |     |     |     |     |      |      |      |      |     |     |     |     |
| F6 sl<br>Standby mode<br>see chap. 4.3.1                    | SLP 0<br>SLP 1*<br>SLP 2<br>SLP 3<br>SLP 4  | Standby mode switched off<br>Standby mode after 5 minutes<br>Standby mode after 10 minutes<br>Standby mode after 20 minutes<br>Standby mode after 30 minutes |   |                              |      |      |                              |      |  |  |     |     |     |      |      |      |      |     |      |     |     |     |     |      |     |      |     |     |     |     |      |      |      |      |     |     |     |     |
| F7 gv   | Not documented  |  |   |                              |      |      |                              |      |  |  |     |     |     |      |      |      |      |     |      |     |     |     |     |      |     |      |     |     |     |     |      |      |      |      |     |     |     |     |
| F8 ci<br>Password entry                                     | In „P1- - “ display increase the flashing number using<br>d= 1/2/5 kg<br>↔, select number using <b>HOLD</b> . Confirm entry by<br><b>ZERO</b> button. |  |   |                              |      |      |                              |      |  |  |     |     |     |      |      |      |      |     |      |     |     |     |     |      |     |      |     |     |     |     |      |      |      |      |     |     |     |     |
| F9 CL   | Adjustment, see chapter 7   |  |   |                              |      |      |                              |      |  |  |     |     |     |      |      |      |      |     |      |     |     |     |     |      |     |      |     |     |     |     |      |      |      |      |     |     |     |     |

\* = default setting

## 7. Adjustment

- ⇒ Switch-off balance and attach a carrying help if necessary.
- ⇒ Switch-on balance with attached carrying help and during the selftest press the **ZERO** and the  $d = \frac{1}{2}/5 \text{ kg}$  button at the same time. „P1 - - -“ is displayed.

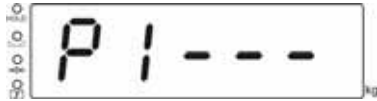

- ⇒ Use the number keys to enter password:

**or**

select standard password „0000“ with **HOLD** number, increase the flashing number using  $d = \frac{1}{2}/5 \text{ kg}$

**or**

personal password, see function F8 ci

- ⇒ Confirm with **ZERO** button, the first function „F0 di“ is displayed.

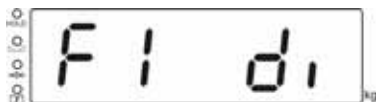

- ⇒ Press the  $d = \frac{1}{2}/5 \text{ kg}$  button repeatedly until „F9 CAL“ will be displayed.



- ⇒ Press the **ZERO** button, „UnLD“ will be displayed.
- ⇒ Unload the balance and wait until the LED  $\triangleleft \triangle$  lights up.



- ⇒ Press the **ZERO** button, the currently set adjustment weight is displayed.
- ⇒ In order to change, select the number to be changed using the **HOLD** button and set the desired value using the  $d = \frac{1}{2}/5 \text{ kg}$  button, the respective active digit flashes.
- ⇒ Confirm by the **ZERO** button, „LoAd“ will be displayed.
- ⇒ Attach the adjustment weight and wait until the LED  $\triangleleft \triangle$  lights up.

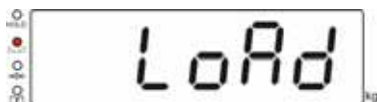

- ⇒ Press the **ZERO** button.
- ⇒ After successful adjustment the balance carries out a selftest, then it automatically returns to weighing mode.  
An adjusting error or incorrect adjusting weight will be indicated by the error message; repeat adjustment procedure

## 8. Error messages

| Error message | Description                                | Possible causes  |
|---------------|--|--|
| --ol-         | Maximum load exceeded                      | ⇒ Reduce load<br>⇒ Check whether the balance has been damaged                      |
| Err 5         | Keyboard error                             | ⇒ Improper operation of the balance  |
| Err 6         | Value outside the A/D changer range        | ⇒ Weighing plate not installed<br>⇒ Damaged weighing cell<br>⇒ Damaged electronics |
| Ba lo         | Capacity of rechargeable battery exhausted | ⇒ Recharge battery   |

Should other error messages occur, switch balance off and then on again. If the error message remains inform manufacturer.



## 9. Cleaning, Maintenance and Disposal

|  |  |
|--|--|
| <br><b>Danger</b> | <p><b>Risk of injury and risk of material damage!</b><br/> <b>The crane scales are part of a hoisting device!</b><br/> <b>For a safe operation please observe the following:</b></p> <ul style="list-style-type: none"> <li>⇒ Have carried out a regular maintenance by trained specialized staff</li> <li>⇒ Carry out regular maintenance and care, see chapter 9.2 and 9.3</li> <li>⇒ Have the parts exchanged only by trained specialized staff.</li> <li>⇒ If there arose discrepancies with the safety checklist, the balance must not more be put into operation.</li> <li>⇒ Do not repair the crane scales by yourself. Repair may only be carried out by service partners authorized by Messrs. KERN.</li> </ul> |
|--|--|

### 9.1 Cleaning and Disposal

|  |  |
|--|--|
| <br><b>CAUTION</b> | <p><b>Damage on the crane scales!</b></p> <ul style="list-style-type: none"> <li>⇒ Do not use any industrial solutions or chemicals</li> </ul> |
|--|--|

- ⇒ Clean the keyboard and the display with a soft cloth soaked in mild window cleaning agent.
- ⇒ Disposal of packaging and appliance must be carried out by operator according to valid national or regional law of the location where the appliance is used.

### 9.2 Regular maintenance and care

- ▲ The regular 3-month maintenance may only be carried out by an expert with competent knowledge of working with crane scales. Thereby the national regulations for prevention of accidents as well as the working, operation and safety regulations of the owner-operator.
- ▲ To check the dimensions only use suitable test devices.
- ▲ The regular 12-month maintenance must only be carried out by trained specialized staff (KERN customer service).
- ▲ The results of the maintenance must be written down in the checklist (chap. 9.3).
- ▲ The additional results of the extended maintenance have to be entered in the checklist (chapter 10.1).
- ▲ The replaced spare parts also must be entered, (chapter 10.2)

## Regular maintenance:

|   |  |
|---|--|
| <p>Initial Commissioning, every <b>3 months</b> or anyway after <b>12 500 weighings</b></p> | <ul style="list-style-type: none"> <li>▪ Check all dimensions, see checklist chap. 9.2</li> <li>▪ Check the shackle or the eyelet for wear and tear, such as e.g. plastic deformation, mechanical damage (unevenness), notches, striation, cracks, corrosion, thread damage and torsions.</li> <li>▪ Check the application of the safety bracket on the hook, moreover check for fault and correct function</li> <li>▪ For balances of big construction size: Check that the split pin and the nut on the shackle are not loose</li> </ul> <p>If a dimension exceeds the admitted deviation from the original dimension (see checklist, chap. 9.3) or if other discrepancies have been found, the balance must be repaired at once by trained specialized staff (KERN customer service). Never do repair it by yourself!<br/>Take balance out of operation immediately!</p> <p>All repairs and spare parts must be documented by the service partner (see list, chap. 10.2).</p> |
| <p>Every <b>12 months</b> or in any case after <b>50 000 weighings</b></p>                  | <ul style="list-style-type: none"> <li>▪ If the enhanced maintenance has to be carried out by trained staff (KERN customer service). At this general revision all load carrying parts must be checked for gaps with magnetic powder</li> </ul>   |
| <p>Every <b>5 years</b> or anyway after <b>250 000 weighings</b></p>                        | <ul style="list-style-type: none"> <li>▪ All load carrying parts have to be exchanged by trained specialized staff (KERN customer service).</li> </ul>   |
| <p>Every <b>10 years</b> or anyway after <b>500 000 weighings</b></p>                       | <ul style="list-style-type: none"> <li>▪ Replace the crane scales entirely</li> </ul>  |

### Note

During the revision watch out for wear and tear according to the following drawings (chap. 9.3).

### 9.3 Checklist „Regular maintenance“, (see chapter 9.2)

|  |        |        |               |                     |              |        |        |        |                    |               |                |                       |  |
|--|--------|--------|---------------|---------------------|--------------|--------|--------|--------|--------------------|---------------|----------------|-----------------------|--|
| <b>Original dimensions crane scales, serial no.:</b> ..... |        |        |               |                     |              |        |        |        |                    |               |                | <b>Capacity</b> ..... |  |
| <b>Shackle</b>   |        |        |               |                     | <b>Hooks</b> |        |        |        |                    |               |                |                       |  |
| a (mm)   | b (mm) | c (mm) | Wear and tear | Split pin&Nut       | d (mm)       | e (mm) | f (mm) | g (mm) | Angle $\alpha$ (°) | Wear and tear | Safety bracket |                       |  |
|  |        |        |               |                     |              |        |        |        |                    |               |                |                       |  |
| <b>Date</b> .....  |        |        |               | <b>Tester</b> ..... |              |        |        |        |                    |               |                |                       |  |

|                             | Shackle |     |     |                                 |               | Hooks |     |     |     |                |                                 |                       | Date | Tester |
|-----------------------------|---------|-----|-----|---------------------------------|---------------|-------|-----|-----|-----|----------------|---------------------------------|-----------------------|------|--------|
|                             | a       | b   | c   | Wear and tear (see grey fields) | Split pin&Nut | d     | e   | f   | g   | Angle $\alpha$ | Wear and tear (see grey fields) | Safety bracket        |      |        |
| Max. admitted variation     | 5 %     | 0 % | 5 % | No deformation or cracks        | tight         | 10 %  | 5 % | 5 % | 5 % | 10 °           | No deformation or cracks        | Perfect working order |      |        |
| Revision prior to first use |         |     |     |                                 |               |       |     |     |     |                |                                 |                       |      |        |
| 3 months / 12 500 x         |         |     |     |                                 |               |       |     |     |     |                |                                 |                       |      |        |
| 6 months / 25 000 x         |         |     |     |                                 |               |       |     |     |     |                |                                 |                       |      |        |
| 9 months / 37 500 x         |         |     |     |                                 |               |       |     |     |     |                |                                 |                       |      |        |
| <b>12 months / 50 000 x</b> |         |     |     |                                 |               |       |     |     |     |                |                                 |                       |      |        |
| 15 months / 62 500 x        |         |     |     |                                 |               |       |     |     |     |                |                                 |                       |      |        |
| 18 months / 75 000 x        |         |     |     |                                 |               |       |     |     |     |                |                                 |                       |      |        |
| 21 months / 87 500 x        |         |     |     |                                 |               |       |     |     |     |                |                                 |                       |      |        |

|                              | Shackle   |     |     |                                 |               | Hooks |     |     |     |                |                                 |                       | Date | Tester |
|------------------------------|---|-----|-----|---------------------------------|---------------|-------|-----|-----|-----|----------------|---------------------------------|-----------------------|------|--------|
|                              | a   | b   | c   | Wear and tear (see grey fields) | Split pin&Nut | d     | e)  | f   | g   | Angle $\alpha$ | Wear and tear (see grey fields) | Safety bracket        |      |        |
| Max. admitted variation      | 5 %   | 0 % | 5 % | No deformation or cracks        | tight         | 10 %  | 5 % | 5 % | 5 % | 10 °           | No deformation or cracks        | Perfect working order |      |        |
| <b>24 months / 100 000 x</b> |   |     |     |                                 |               |       |     |     |     |                |                                 |                       |      |        |
| 27 months / 112 500 x        |   |     |     |                                 |               |       |     |     |     |                |                                 |                       |      |        |
| 30 months / 125 000 x        |   |     |     |                                 |               |       |     |     |     |                |                                 |                       |      |        |
| 33 months / 137 500 x        |   |     |     |                                 |               |       |     |     |     |                |                                 |                       |      |        |
| <b>36 months / 150 000 x</b> |   |     |     |                                 |               |       |     |     |     |                |                                 |                       |      |        |
| 39 months / 162 500 x        |   |     |     |                                 |               |       |     |     |     |                |                                 |                       |      |        |
| 42 months / 175 000 x        |   |     |     |                                 |               |       |     |     |     |                |                                 |                       |      |        |
| 45 months / 187 500 x        |   |     |     |                                 |               |       |     |     |     |                |                                 |                       |      |        |
| <b>48 months/200 000</b>     |   |     |     |                                 |               |       |     |     |     |                |                                 |                       |      |        |
| 51 months / 212 500 x        |   |     |     |                                 |               |       |     |     |     |                |                                 |                       |      |        |
| 54 months / 225 000 x        |   |     |     |                                 |               |       |     |     |     |                |                                 |                       |      |        |
| 57 months / 237 500 x        |   |     |     |                                 |               |       |     |     |     |                |                                 |                       |      |        |
| <b>60 months/250 000x</b>    | ➔ All load carrying parts have to be exchanged by a service partner authorized by KERN. |     |     |                                 |               |       |     |     |     |                |                                 |                       |      |        |

**bold letters** = this maintenance work has to be carried out by a service partner authorized by KERN.

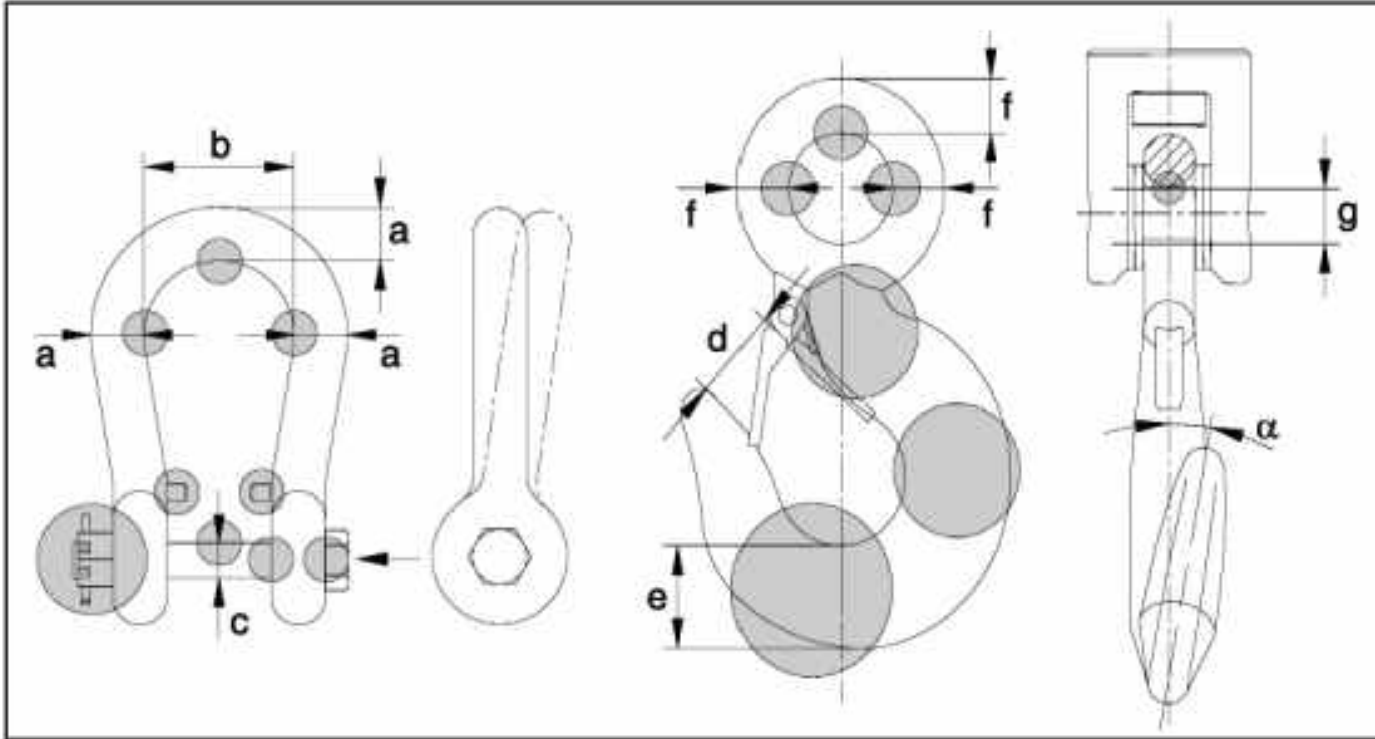

## 10. Appendix

### 10.1 Checklist „Enhanced maintenance“ (General revision)

The enhanced maintenance has to be carried out by a service partner authorized by KERN.

| Crane scales           |                                 | Model ..... Serial no. .... |         |                     |      |      |           |
|------------------------|---------------------------------|-----------------------------|---------|---------------------|------|------|-----------|
| Interval               | Magnetic powder test for cracks | Hooks                       | Shackle | Screwed connections | Date | Name | Signature |
| 12 months / 50 000 x   |                                 |                             |         |                     |      |      |           |
| 24 months / 100 000 x  |                                 |                             |         |                     |      |      |           |
| 36 months / 150 000 x  |                                 |                             |         |                     |      |      |           |
| 48 months / 200 000 x  |                                 |                             |         |                     |      |      |           |
| 60 months / 250 000 x  |                                 |                             |         |                     |      |      |           |
| 72 months / 300 000 x  |                                 |                             |         |                     |      |      |           |
| 84 months / 350 000 x  |                                 |                             |         |                     |      |      |           |
| 96 months / 400 000 x  |                                 |                             |         |                     |      |      |           |
| 108 months / 450 000 x |                                 |                             |         |                     |      |      |           |
| 120 months/500 000x    | ➔ Replace crane scales entirely |                             |         |                     |      |      |           |

## 10.2 List „spare parts and repair of safety-relevant parts“

Repair has to be carried out by a service partner authorized by KERN.

| Crane scales |        | Model ..... Serial no. .... |      |           |
|--------------|--------|-----------------------------|------|-----------|
| Part         | Action | Date                        | Name | Signature |
|              |        |                             |      |           |
|              |        |                             |      |           |
|              |        |                             |      |           |
|              |        |                             |      |           |
|              |        |                             |      |           |
|              |        |                             |      |           |
|              |        |                             |      |           |
|              |        |                             |      |           |
|              |        |                             |      |           |
|              |        |                             |      |           |
|              |        |                             |      |           |
|              |        |                             |      |           |
|              |        |                             |      |           |
|              |        |                             |      |           |

|                     |                             |             |             |                  |
|---------------------|-----------------------------|-------------|-------------|------------------|
| <b>Crane scales</b> | Model ..... Serial no. .... |             |             |                  |
| <b>Part</b>         | <b>Action</b>               | <b>Date</b> | <b>Name</b> | <b>Signature</b> |
|                     |                             |             |             |                  |
|                     |                             |             |             |                  |
|                     |                             |             |             |                  |
|                     |                             |             |             |                  |
|                     |                             |             |             |                  |
|                     |                             |             |             |                  |
|                     |                             |             |             |                  |
|                     |                             |             |             |                  |
|                     |                             |             |             |                  |
|                     |                             |             |             |                  |
|                     |                             |             |             |                  |
|                     |                             |             |             |                  |
|                     |                             |             |             |                  |