

Operating instructions

Touch screen-Industrial Balance

KERN FKT / IKT / PKT

Version 3.4
01/2014
GB





KERN FKT / IKT / PKT

Version 3.4 01/2014

Operating instructions

Touch screen-Industrial Balance

Table of Contents

1	Technical Data	4
2	Basic Information (General)	17
2.1	Proper use.....	17
2.2	Improper Use	17
2.3	Warranty	17
2.4	Monitoring of Test Resources	17
3	Basic Safety Precautions	18
3.1	Pay attention to the instructions in the Operation Manual	18
3.2	Personnel training	18
4	Transportation & Storage	18
4.1	Testing upon acceptance	18
4.2	Packaging / return transport	18
5	Unpacking, Setup and Commissioning	19
5.1	Installation Site, Location of Use.....	19
5.2	Unpacking	19
5.2.1	Placing.....	19
5.3	Mains connection	19
5.4	Connection of peripheral devices.....	19
5.5	Initial Commissioning	19
5.6	Adjustment.....	20
5.7	Adjustment.....	20
5.8	Verification	20
6	Operation	21
6.1	How to turn on/off balance.....	21
6.2	Screen Operating mode Weighing.....	24
6.3	Screen operating mode Counting.....	25
6.4	Screen Operating mode Totalizing.....	27
6.5	Screen Operating mode Dispensing	29
6.6	Screen Operating mode Check weighing	31
6.7	Screen Operating mode Percentage	33
6.8	Screen Operating mode Animal weighing	35
6.9	Screen Operating mode Formulation	37
6.10	Screen Operating mode Surface weight	39
6.11	Screen Operating mode Density	41
6.12	Forms.....	43
7	Print form	44
7.1	Contents of the form impression.....	44
7.2	Arrangement of form printout	45

8	Interfaces	46
8.1	Digital I/O output - open collectors (only model FKT/IKT)	46
8.2	Data output RS 232 C	47
8.3	Interface RS 232C	47
8.3.1	There are 4 kinds of data output via RS 232C.....	48
8.3.2	Explanation of the data transfer	48
8.4	Printer	49
8.5	Underfloor weighing.....	49
9	Service, maintenance, disposal	50
9.1	Cleaning.....	50
9.2	Service, maintenance	50
9.3	Disposal.....	50
10	Instant help	51
11	Declaration of conformity	52

1 Technical Data

Models FKT:

KERN	FKT 6K0.02	FKT 6K0.05	FKT 6K0.1	FKT 12K0.05
Readability (d)	0.02 g	0.05 g	0.1 g	0.05 g
Weighing range (max)	6 000 g	6 000 g	6 000 g	12 000 g
Taring range (subtractive)	6 000 g	6 000 g	6 000 g	12 000 g
Reproducibility	0.04 g	0.05 g	0.2 g	0.05 g
Linearity	±0.1 g	±0.15 g	±0.2 g	±0.15 g
Smallest piece weight	0.02 g	0.05 g	0.1 g	0.05 g
Adjustment points	2/5/6 kg	2/5/6 kg	2/5/6 kg	2/5/10/12 kg
Recommended adjusting weight F1 (not supplied)	5 kg	5 kg	5 kg	10 kg
Humidity of air	max. 80% rel. (non-condensing)			
Stabilization time (typical)	3 sec.			
Allowable ambient temperature	+10 °C ... + 40 °C			
Warm-up time	4 h	2 h	2 h	2 h
Housing (B x D x H) mm	270 x 345 x 106			
Vibration filter	yes			
Weighing plate stainless steel mm	253 x 228			
Units	see menu			
Weight kg (net)	3.3			
Data interface	yes (RS232)			
Master data storage for all operating modes	80			
Print forms with up to 20 informations	16			
Recipes with up to 10 components	99			

KERN	FKT 12K0.1	FKT 12K0.2	FKT 24K0.1	FKT 24K0.2
Readability (d)	0.1 g	0.2 g	0.1 g	0.2 g
Weighing range (max)	12 000 g	12 000 g	24 000 g	24 000 g
Taring range (subtractive)	12 000 g	12 000 g	24 000 g	24 000 g
Reproducibility	0.1 g	0,2 g	0.1 g	0.2 g
Linearity	±0.3 g	±0.4 g	±0.3 g	±0.6 g
Smallest piece weight	0.1 g	0.2 g	0.1 g	0.2 g
Adjustment points	2/5/10/12 kg	2/5/10/12 kg	5/10/15/20/24 kg	5/10/15/20/24 kg
Recommended adjusting weight F1 (not supplied)	10 kg	10 kg	20 kg	20 kg
Humidity of air	max. 80% rel. (non-condensing)			
Stabilization time (typical)	3 sec.			
Allowable ambient temperature	+10 °C ... + 40 °C			
Warm-up time	4 h	2 h	2 h	2 h
Housing (B x D x H) mm	270 x 345 x 106			
Vibration filter	yes			
Weighing plate stainless steel mm	253 x 228			
Units	see menu			
Weight kg (net)	3.3			
Data interface	yes (RS232)			
Master data storage for all operating modes	80			
Print forms with up to 20 informations	16			
Recipes with up to 10 components	99			

KERN	FKT 6K0.02L	FKT 16K0.05L	FKT 16K0.1L	FKT 30K0.5L	FKT 36K0.1L
Readability (d)	0.02 g	0.05 g	0.1 g	0,5 g	0.1 g
Weighing range (max)	6 000 g	16 000 g	16 000 g	30.000 g	36 000 g
Taring range (subtractive)	6 000 g	16 000 g	16 000 g	30.000 g	36 000 g
Reproducibility	0.04 g	0.1 g	0.1 g	0,5 g	0.2 g
Linearity	±0.1 g	±0.25 g	±0.3 g	±1,0 g	±0.5 g
Smallest piece weight	0.02 g	0.05 g	0.1 g	0,5 g	0.1 g
Adjustment points	2/4/5/6 kg	5/10/15/16 kg	5/10/15/16 kg	10/20/30 kg	10/20/30/36 kg
Recommended adjusting weight F1 (not supplied)	5 kg	10 kg + 5 kg	10 kg + 5 kg	20 kg+10 kg	20 kg + 10 kg
Humidity of air	max. 80% rel. (non-condensing)				
Stabilization time (typical)	3 sec.				
Permitted environmental temperature	+10 °C ... + 40 °C				
Warm-up time	4 h	4 h	2 h	2 h	4 h
Housing (B x D x H) mm	350 x 390 x 120				
Vibration filter	yes				
Weighing plate stainless steel mm	340 x 240				
Units	see menu				
Weight kg (net)	6.5				
Data interface	yes (RS232)				
Master data storage for all operating modes	80				
Print forms with up to 20 informations	16				
Recipes with up to 10 components	99				
Battery operation with 6 x 1,5 V, Size C	yes				

KERN	FKT 36K0.2L	FKT 60K1L	FKT 65K0.2L	FKT 65K0.5L
Readability (d)	0.2 g	1 g	0.2 g	0.5 g
Weighing range (max)	36 000 g	60 000 g	65 000 g	65 000 g
Taring range (subtractive)	36 000 g	60 000 g	65 000 g	65 000 g
Reproducibility	0.2 g	1 g	0.4 g	0.5 g
Linearity	±0.6 g	±2 g	± 1.0 g	± 1.5 g
Smallest piece weight	0.2 g	1 g	0.2 g	0.5 g
Adjustment points	10/20/30/36 kg	20/50/60 kg	20/30/50/60 kg	20/30/50/60 kg
Recommended adjusting weight F1 (not supplied)	20 kg + 10 kg	50 kg	50 kg	50 kg
Humidity of air	max. 80% rel. (non-condensing)			
Stabilization time (typical)	3 sec.			
Allowable ambient temperature	+10 °C ... + 40 °C			
Warm-up time	2 h	2 h	4 h	2 h
Housing (B x D x H) mm	350 x 390 x 120			
Vibration filter	yes			
Weighing plate stainless steel mm	340 x 240			
Units	see menu			
Weight kg (net)	6,5			
Data interface	yes (RS232)			
Master data storage for all operating modes	80			
Print forms with up to 20 informations	16			
Recipes with up to 10 components	99			
Battery operation with 6 x 1,5 V, Size C	yes			

KERN	FKT 6K1LM	FKT 12K2LM	FKT 30K5LM	FKT 60K10LM
Accuracy class	III	III	III	III
Readability (d)	1 g	2 g	5 g	10 g
Verification value (e)	1 g	2 g	5 g	10 g
Weighing range (max)	6 000 g	12 000 g	30 000 g	60 000 g
Minimum load (Min)	20 g	40 g	100 g	200 g
Taring range (subtractive)	6 000 g	12 000 g	30 000 g	60 000 g
Reproducibility	0.5 g	1 g	2.5 g	5 g
Linearity	±0.5 g	±1 g	± 2.5 g	± 5 g
Smallest piece weight	1 g	2 g	5 g	10 g
Adjustment points	2/5/6 kg	2/5/10/12 kg	10/20/30 kg	20/50/60 kg
Recommended adjusting weight M1 (not supplied)	5 kg	10 kg	20 + 10 kg	50 kg
Humidity of air	max. 80% rel. (non-condensing)			
Stabilization time (typical)	3 sec.			
Allowable ambient temperature	+10 °C ... + 40 °C			
Warm-up time	2 h	2 h	2 h	2 h
Housing (B x D x H) mm	270 x 345 x 106		350 x 390 x 120	
Vibration filter	yes			
Weighing plate stainless steel mm	253 x 228		340 x 240	
Units	see menu			
Weight kg (net)	3.3		6.5	
Data interface	yes (RS232)			
Master data storage for all operating modes	40			
Print forms with up to 20 informations	1			
Recipes with up to 7 components	5			
Battery operation with 6 x 1,5 V, Size C	yes			

Models IKT:

KERN	IKT 3K0.01S	IKT 10K0.1S	IKT 6K0.1	IKT 8K0.05
Readability (d)	0.01 g	0.1 g	0.1 g	0.05 g
Weighing range (max)	3 000 g	10 000 g	6 000 g	8 000 g
Taring range (subtractive)	3 000 g	10 000 g	6 000 g	8 000 g
Reproducibility	0.02 g	0.1 g	0.1 g	0.05 g
Linearity	±0.05 g	±0.3 g	±0.3 g	±0.15 g
Smallest piece weight	0.01 g	0.1 g	0.1 g	0.05 g
Adjustment points	1/2/3 kg	2/5/10 kg	2/5/10 kg	2/4/5/7/8 kg
Recommended adjusting weight F1 (not supplied)	3 kg	10 kg	6 kg	5 kg + 2 kg
Humidity of air	max. 80% rel. (non-condensing)			
Stabilization time (typical)	3 sec.			
Allowable ambient temperature	+10 °C ... + 40 °C			
Warm-up time	4 h	2 h	2 h	2 h
Housing (B x D x H) mm	228 x 228 x 70		315 x 305 x 70	
Vibration filter	yes			
Weighing plate stainless steel mm	228 x 228		315 x 305	
Units	see menu			
Weight kg (net)	5.5		7.5	
Data interface	yes (RS232)			
Master data storage for all operating modes	80			
Print forms with up to 20 informations	16			
Recipes with up to 10 components	99			

KERN	IKT 12K0.2	IKT 16K0.1	IKT 30K0.1	IKT 30K0.5	IKT 36K0.2
Readability (d)	0.2 g	0.1 g	0.1 g	0.5 g	0.2 g
Weighing range (max)	12 000 g	16 000 g	30 000 g	30 000 g	36 000 g
Taring range (subtractive)	12 000 g	16 000 g	30 000 g	30 000 g	36 000 g
Reproducibility	0.2 g	0.1 g	0.2 g	0.5 g	0.2 g
Linearity	±0.6 g	±0.3 g	±0.5 g	±1.0 g	±0.6 g
Smallest piece weight	0.2 g	0.1 g	0.1 g	0.5 g	0.2 g
Adjustment points	5/10/12 kg	5/10/15/16 kg	10/15/20/30 kg	10/15/20/30 kg	10/15/20/30/36 kg
Recommended adjusting weight F1 (not supplied)	10 kg	10 kg + 5 kg	20kg + 10kg	20kg + 10kg	20kg + 10kg
Humidity of air	max. 80% rel. (non-condensing)				
Stabilization time (typical)	3 sec.				
Allowable ambient temperature	+10 °C ... + 40 °C				
Warm-up time	2 h	2 h	4 h	2 h	2 h
Housing (B x D x H) mm	315 x 305 x 70				
Vibration filter	yes				
Weighing plate stainless steel mm	315 x 305				
Units	see menu				
Weight kg (net)	7,5				
Data interface	yes (RS232)				
Master data storage for all operating modes	80				
Print forms with up to 20 informations	16				
Recipes with up to 10 components	99				

KERN	IKT 30K0.1L	IKT 36K0.2L	IKT 60K0.2L	IKT 60K1L
Readability (d)	0.1 g	0.2 g	0.2 g	1 g
Weighing range (max)	30 000 g	36 000 g	60 000 g	60 000 g
Taring range (subtractive)	30 000 g	36 000 g	60 000 g	60 000 g
Reproducibility	0.2 g	0.2 g	0.4 g	1 g
Linearity	±0.5 g	±0.6 g	±1.0 g	±2.0 g
Smallest piece weight	0.1 g	0.2 g	0.2 g	1 g
Adjustment points	10/15/20/30 kg	10/15/20/30/36 kg	20/30/50/60 kg	20/30/50/60 kg
Recommended adjusting weight F1 (not supplied)	20 kg + 10 kg	20 kg + 10 kg	50 kg	50 kg
Humidity of air	max. 80% rel. (non-condensing)			
Stabilization time (typical)	3 sec.			
Allowable ambient temperature	+10 °C ... + 40 °C			
Warm-up time	4 h	2 h	4 h	2 h
Housing (B x D x H) mm	450 x 350 x 115			
Vibration filter	yes			
Weighing plate stainless steel mm	450 x 350			
Units	see menu			
Weight kg (net)	9.5			
Data interface	yes (RS232)			
Master data storage for all operating modes	80			
Print forms with up to 20 informations	16			
Recipes with up to 10 components	99			

KERN	IKT 65K0.5L	IKT 100K0.5L	IKT 120K2L	IKT 150K1L
Readability (d)	0.5 g	0.5 g	2 g	1 g
Weighing range (max)	65 000 g	100 000 g	120 000 g	150 000 g
Taring range (subtractive)	65 000 g	100 000 g	120 000 g	150 000 g
Reproducibility	0.5 g	0.5 g	2 g	1 g
Linearity	±1,5 g	±1,5 g	±4 g	±3 g
Smallest piece weight	0.5 g	0.5 g	2 g	1 g
Adjustment points	20/30/50/60 kg	20/50/100 kg	20/30/50/60 kg	50/100/150 kg
Recommended adjusting weight F1 (not supplied)	50 kg	50 kg + 50 kg	50 kg	3 x 50 kg
Humidity of air	max. 80% rel. (non-condensing)			
Stabilization time (typical)	3 sec.			
Allowable ambient temperature	+10 °C ... + 40 °C			
Warm-up time	2 h	2 h	2 h	2 h
Housing (B x D x H) mm	450 x 350 x 115			
Vibration filter	yes			
Weighing plate stainless steel mm	450 x 350			
Units	see menu			
Weight kg (net)	9.5			
Data interface	yes (RS232)			
Master data storage for all operating modes	80			
Print forms with up to 20 informations	16			
Recipes with up to 10 components	99			

KERN	IKT 150K2XL	IKT 300K5XL
Readability (d)	2 g	5 g
Weighing range (max)	150 000 g	300 000 g
Taring range (subtractive)	150 000 g	300 000 g
Reproducibility	2 g	5 g
Linearity	±4 g	±10 g
Smallest piece weight	2 g	10 g
Adjustment points	20/50/100 kg	20/30/50/60 kg
Recommended adjusting weight F1 (not supplied)	3 x 50 kg	3 x 100 kg
Humidity of air	max. 80% rel. (non-condensing)	
Stabilization time (typical)	3 sec.	
Allowable ambient temperature	+10 °C ... + 40 °C	
Warm-up time	2 h	2 h
Housing (B x D x H) mm	650 x 500 x 142	
Vibration filter	yes	
Weighing plate stainless steel mm	650 x 500	
Units	see menu	
Weight kg (net)	20	
Data interface	yes (RS232)	
Master data storage for all operating modes	80	
Print forms with up to 20 informations	16	
Recipes with up to 10 components	99	

KERN	IKT 6K1M	IKT 12K2M	IKT 30K5M	IKT 60K10LM	IKT 120K20LM
Accuracy class	III	III	III	III	III
Readability (d)	1 g	2 g	5 g	10 g	20 g
Verification value (e)	1 g	2 g	5 g	10 g	20 g
Weighing range (max)	6 000 g	12 000 g	30 000 g	60 000 g	120 000 g
Minimum load (Min)	20 g	40 g	100 g	200 g	400 g
Taring range (subtractive)	6 000 g	12 000 g	30 000 g	60 000 g	120 000 g
Reproducibility	0.5 g	1 g	2.5 g	5 g	10 g
Linearity	±0.5 g	±1 g	± 2.5 g	± 5 g	± 10 g
Smallest piece weight	1 g	2 g	5 g	10 g	20 g
Adjustment points	2/5/6 kg	2/5/10/12 kg	10/20/30 kg	20/50/60 kg	20/50/100/120 kg
Recommended adjusting weight M1 (not supplied)	10 kg	10 kg	20 + 10 kg	50 kg	50kg+50kg
Humidity of air	max. 80% rel. (non-condensing)				
Stabilization time (typical)	3 sec.				
Allowable ambient temperature	+10 °C ... + 40 °C				
Warm-up time	2 h	2 h	2 h	2 h	2 h
Housing (B x D x H) mm	315 x 305 x 70			450 x 350 x 115	
Vibration filter	yes				
Weighing plate stainless steel mm	315 x 305			450 x 350	
Units	see menu				
Weight kg (net)	7.5			9.5	
Data interface	yes (RS232)				
Master data storage for all operating modes	40				
Print forms with up to 20 informations	1				
Recipes with up to 7 components	5				

Models PKT:

KERN	PKT 300-3	PKT 420-3	PKT 3000-2	PKT4200-2
Readability (d)	0.001 g	0.001 g	0.01 g	0.01 g
Weighing range (max)	300 g	420 g	3 000 g	4 200 g
Taring range (subtractive)	300 g	420 g	3 000 g	4 200 g
Reproducibility	0.002 g	0.002 g	0.02 g	0.02 g
Linearity	±0.005 g	±0.005 g	±0.05 g	±0.05 g
Smallest piece weight	0.001 g	0.001 g	0.01 g	0.01 g
Adjustment points	50/100/200/300 g	100/200/300/400 g	1.0/1.5/2.0/3.0 g	1.0/2.0/3.0/4.0 g
Recommended adjusting weight F1 (not supplied)	200 g + 100 g	200 g + 200 g	2 kg + 1 kg	2 kg + 2 kg
Humidity of air	max. 80% rel. (non-condensing)			
Stabilization time (typical)	3 sec.			
Allowable ambient temperature	+10 °C ... + 40 °C			
Warm-up time	4 h	4 h	4 h	4 h
Housing (B x D x H) mm	180 x 310 x 90			
Vibration filter	yes			
Weighing plate stainless steel mm	Ø 106		Ø 150	
Units	see menu			
Weight kg (net)	2.3			
Data interface	yes (RS232)			
Master data storage for all operating modes	80			
Print forms with up to 20 informations	16			
Recipes with up to 10 components	99			

KERN	PKT 12K0.05	PKT 16K0.1	PKT 24K0.1
Readability (d)	0.05 g	0.1 g	0.1 g
Weighing range (max)	12 000 g	16 000 g	24 000 g
Taring range (subtractive)	12 000 g	16 000 g	24 000 g
Reproducibility	0.05 g	0.1 g	0.1 g
Linearity	±0.15 g	±0.3 g	±0.3 g
Smallest piece weight	0.05 g	0.1 g	0.1 g
Adjustment points	2/5/10/12 kg	5/10/15/16 kg	5/10/15/20/24 kg
Recommended adjusting weight F1 (not supplied)	10 kg	10 kg + 5 kg	20 kg
Humidity of air	max. 80% rel. (non-condensing)		
Stabilization time (typical)	3 sec.		
Allowable ambient temperature	+10 °C ... + 40 °C		
Warm-up time	2 h	2 h	2 h
Housing (B x D x H) mm	180 x 310 x 90		
Vibration filter	yes		
Weighing plate stainless steel mm	160 x 200		
Units	see menu		
Weight kg (net)	2.7		
Data interface	yes (RS232)		
Master data storage for all operating modes	80		
Print forms with up to 20 informations	16		
Recipes with up to 10 components	99		

2 Basic Information (General)

It is absolutely necessary that you read and understand the operating instructions prior to installation and commissioning and follow the instructions during the process!

2.1 Proper use

The balance you purchased is intended to determine the weighing value of material to be weighed. It is intended to be used as a “non-automatic“ balance, i.e. the material to be weighed is manually and carefully placed in the centre of the weighing plate. As soon as a stable weighing value is reached the weighing value can be read.

2.2 Improper Use

Do not use balance for dynamic weighing. In the event that small quantities are removed or added to the material to be weighed, incorrect weighing results can be displayed due to the “stability compensation“ in the balance (Example: Slowly draining fluids from a container on the balance.).

Do not leave permanent load on the weighing plate. This may damage the measuring system.

Impacts and overloading exceeding the stated maximum load (max) of the balance, minus a possibly existing tare load, must be strictly avoided. Balance may be damage by this.

Never operate balance in explosive environment. The serial version is not explosion protected.

The structure of the balance may not be modified. This may lead to incorrect weighing results, safety-related faults and destruction of the balance.

The balance may only be used according to the described conditions. Other areas of use must be released by KERN in writing.

2.3 Warranty

Warranty claims shall be voided in case

- Our conditions in the operation manual are ignored
- The appliance is used outside the described uses
- The appliance is modified or opened
- mechanical damage and damage caused by media, liquids
- natural wear and tear
- The appliance is improperly set up or incorrectly electrically connected
- The measuring system is overloaded

2.4 Monitoring of Test Resources

In the framework of quality assurance the measuring-related properties of the balance and, if applicable, the testing weight, must be checked regularly. The responsible user must define a suitable interval as well as type and scope of this test. Information is available on KERN's home page (www.kern-sohn.com) with regard to the monitoring of balance test substances and the test weights required for this. Our accredited DKD calibration laboratory offers fast and inexpensive adjustment for test weights and weighing balances (reset to national normal weight).

3 Basic Safety Precautions

3.1 Pay attention to the instructions in the Operation Manual



Carefully read this operation manual before setup and commissioning, even if you are already familiar with KERN balances.

Versions in other languages are non-binding translations.
The only binding version is the original document in German.

3.2 Personnel training

The appliance may only be operated and maintained by trained personnel.

4 Transportation & Storage

4.1 Testing upon acceptance

When receiving the appliance, please check packaging immediately, and the appliance itself when unpacking for possible visible damage.

In case of visible damage have the damage verified by the messenger's signature. Do not alter goods or packaging and do not remove any parts of the delivery. Report the damage immediately (within 24 hours) in writing to the parcel service.

4.2 Packaging / return transport



- ⇒ Keep all parts of the original packaging for a possibly required return.
- ⇒ Only use original packaging for returning.
- ⇒ Prior to dispatch disconnect all cables and remove loose/mobile parts.
- ⇒ Reattach possibly supplied transport securing devices.
- ⇒ Secure all parts such as the glass wind screen, the weighing platform, power unit etc. against shifting and damage.

5 Unpacking, Setup and Commissioning

5.1 Installation Site, Location of Use

The balances are designed in a way that reliable weighing results are achieved in common conditions of use.

You will work accurately and fast, if you select the right location for your balance.

Therefore, observe the following for the installation site:

- Place the balance on a firm, level surface;
- Avoid extreme heat as well as temperature fluctuation caused by installing next to a radiator or in the direct sunlight;
- Protect the balance against direct draughts due to open windows and doors;
- Avoid jarring during weighing;
- Protect the balance against high humidity, vapors and dust;
- Do not expose the device to extreme dampness for longer periods of time. Non-permitted condensation (condensation of air humidity on the appliance) may occur if a cold appliance is taken to a considerably warmer environment. In this case, acclimatize the disconnected appliance for ca. 2 hours at room temperature.
- Avoid static charging of the material to be weighed, weighing container and windshield.

If electro-magnetic fields or static charge occur, or if the power supply is unstable major deviations on the display (incorrect weighing results) are possible. In that case, the location must be changed.

5.2 Unpacking

Carefully remove the balance from the packaging, remove plastic cover and setup balance at the intended workstation.

5.2.1 Placing

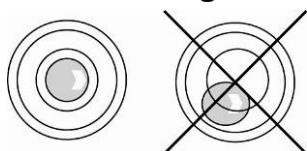

Level balance with foot screws until the air bubble of the water balance is in the prescribed circle.

5.3 Mains connection

Power is supplied via the external mains adapter. The stated voltage value must be the same as the local voltage.

Only use original KERN mains adapters. Using other makes requires consent by KERN.

5.4 Connection of peripheral devices

Before connecting or disconnecting of additional devices (printer, PC) to the data interface, always disconnect the balance from the power supply. With your balance, only use accessories and peripheral devices by KERN, as they are ideally tuned to your balance.

5.5 Initial Commissioning

A warming up time of 2 hours after switching on stabilizes the measuring values.

The accuracy of the balance depends on the local acceleration of gravity.

Strictly observe hints in chapter "Adjustment".

5.6 Adjustment

As the acceleration value due to gravity is not the same at every location on earth, each balance must be coordinated - in compliance with the underlying physical weighing principle - to the existing acceleration due to gravity at its place of location (only if the balance has not already been adjusted to the location in the factory). This adjustment process must be carried out during the initial start-up, after change in location and variation of surrounding temperature. To receive accurate measuring values it is also recommended to adjust the balance periodically in weighing operation.

5.7 Adjustment

With an adjustment weight, the weighing accuracy can be checked and re-adjusted at any time.

Attention: In the verified balances the adjustment is not possible.

Procedure when adjusting:

Observe stable environmental conditions. A short warming up time of ca. 15 minutes is recommended for stabilization.

5.8 Verification

General introduction:

According to EU directive 90/384/EEC balances must be verified if they are used as follows (legally controlled area):

- a) For commercial transactions if the price of goods is determined by weighing.
- b) For the production of medicines in pharmacies as well as for analyses in the medical and pharmaceutical laboratory.
- c) For official purposes
- d) For manufacturing final packages

In cases of doubt, please contact your local trade in standard.

Verification instructions

An EU type approval exists for balances described in their technical data as verifiable. If a balance is used where obligation to verify exists as described above, it must be verified and re-verified in regular intervals.

Re-verification of a balance is carried out according to the respective national regulations. The validity for verification of balances in Germany is e.g. 2 years.

The legal regulation of the country where the balance is used must be observed!

6 Operation

6.1 How to turn on/off balance

To turn on touch the screen surface

Turn off by touching the **OFF** surface command

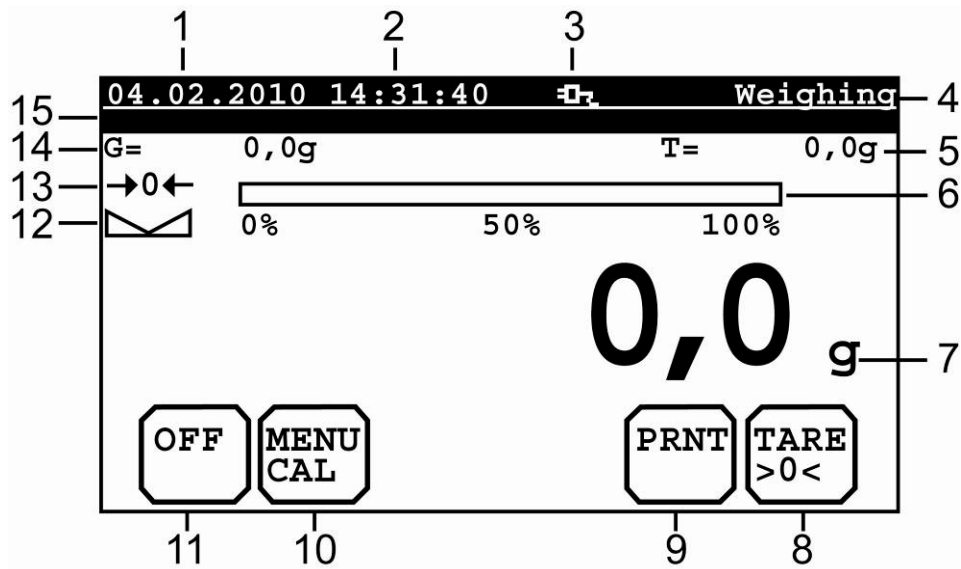

All fields with rounded corners are touch fields.

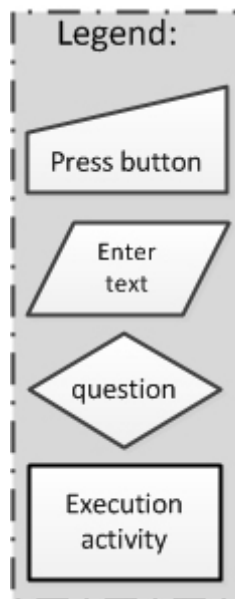

Basic settings:

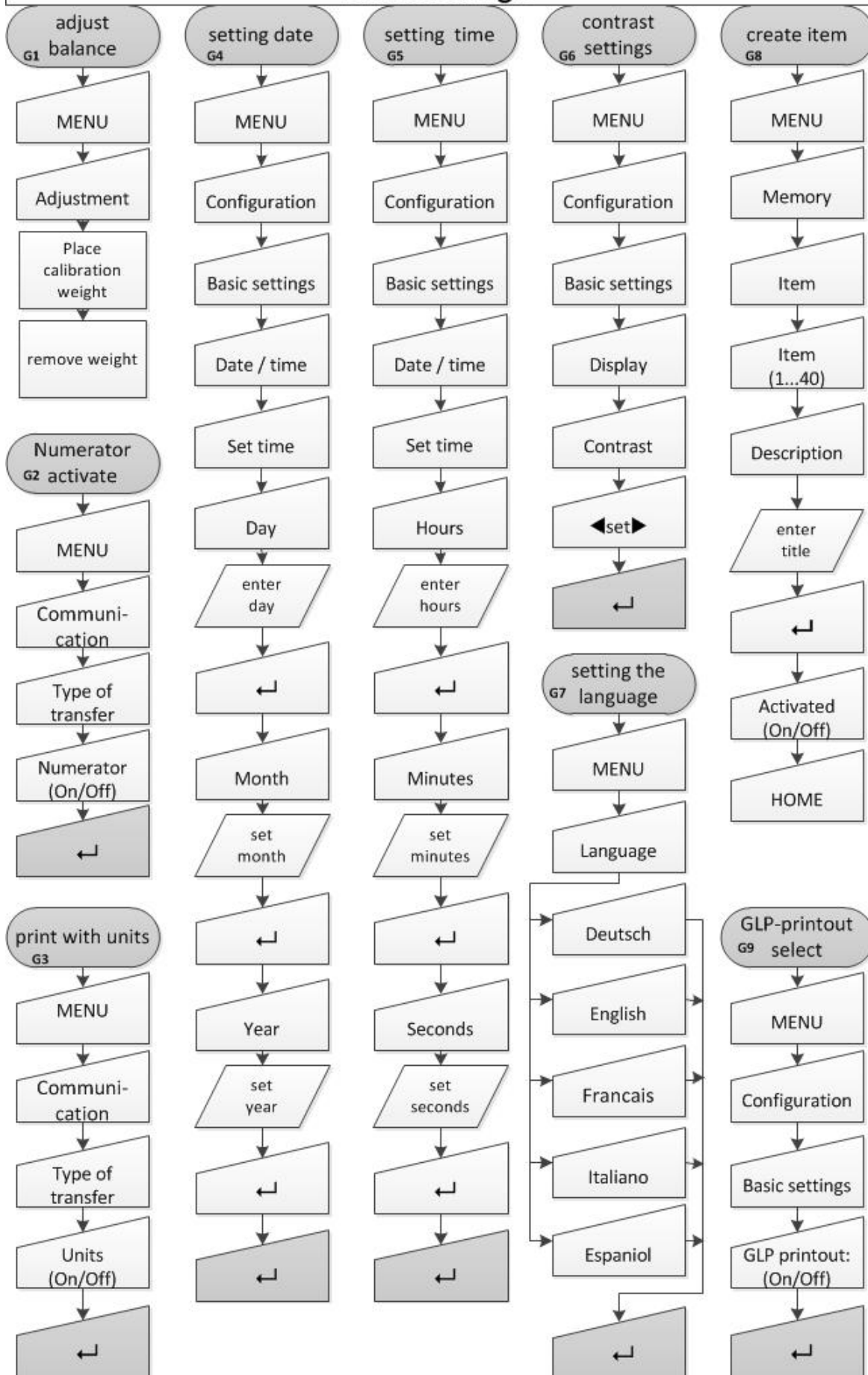

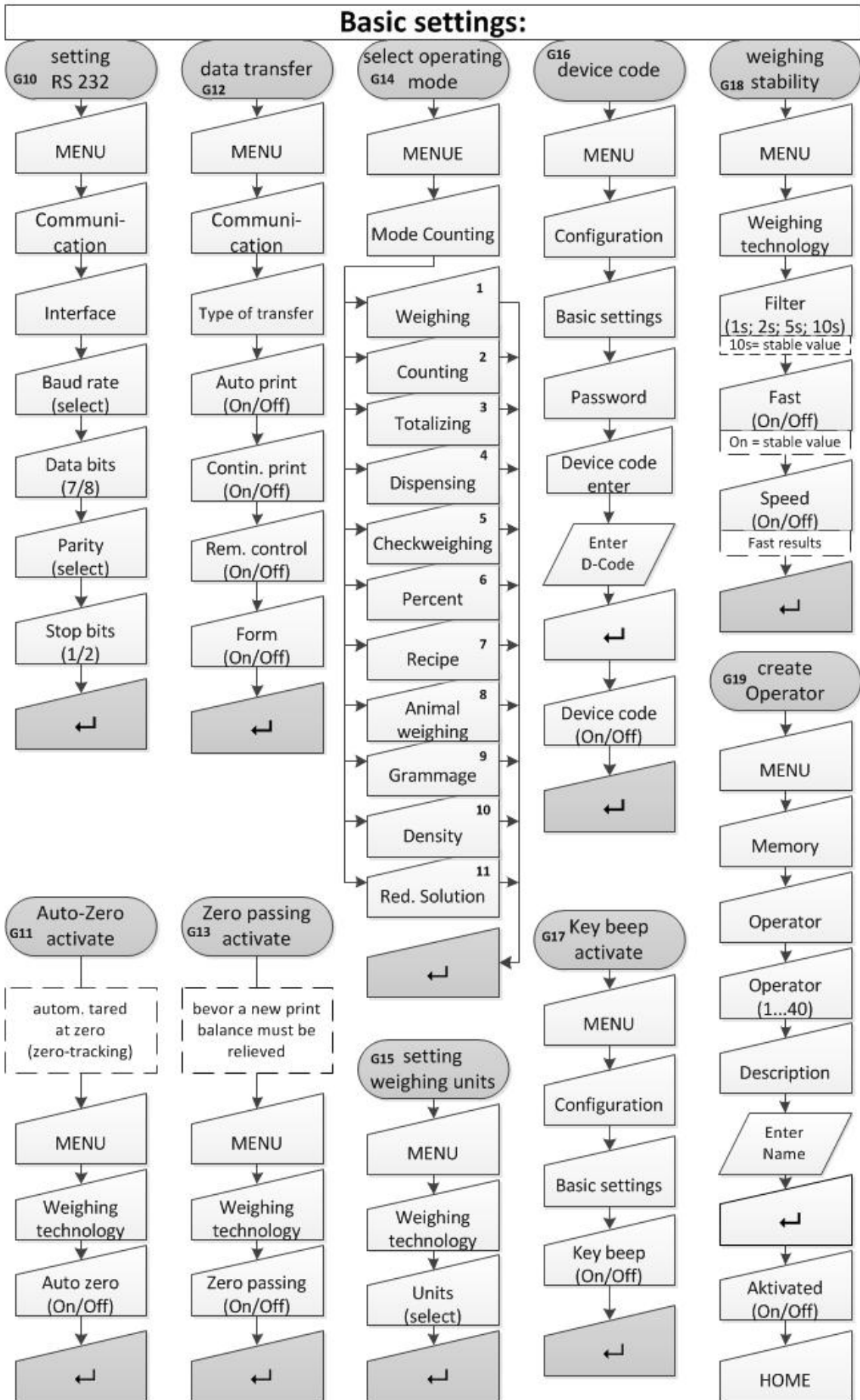

6.2 Screen Operating mode Weighing

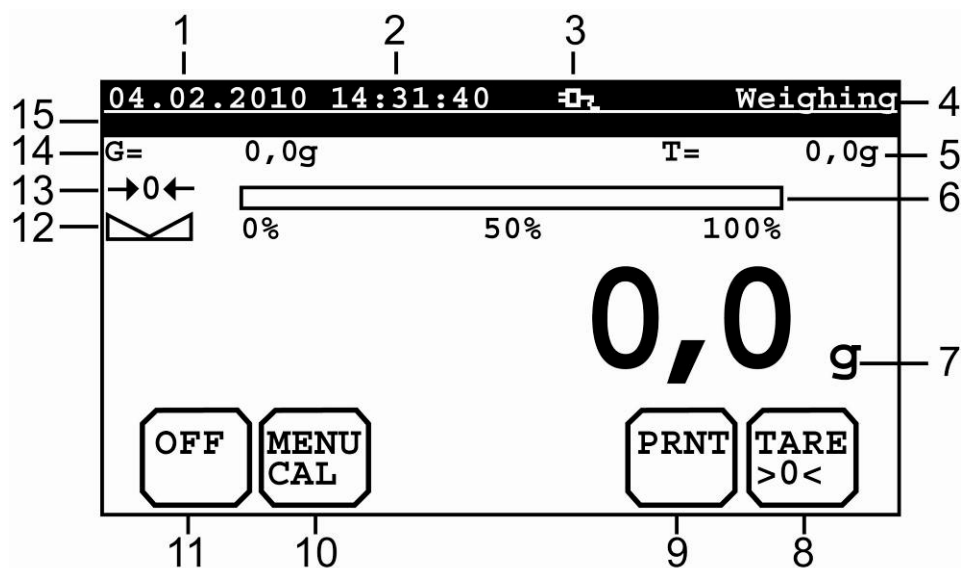

Display	Designation
1	Date
2	Time
3	Battery or mains operation
4	Operation modus
5	Tare value
6	Range display
7	Unity of displayed value
8	Tare and zero set button
9	Print button
10	Menu button
11	„Switch-off“ button
12	Weighing stoppage
13	Zeroing display
14	Gross value
15	Info line for operator, article, etc.

6.3 Screen operating mode Counting

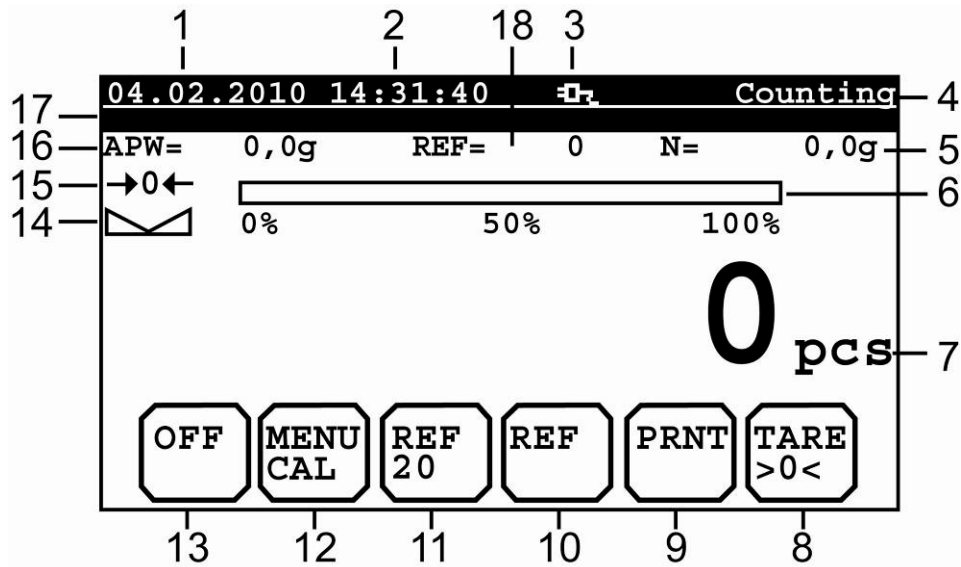

Display	Designation
1	Date
2	Time
3	Battery or mains operation
4	Operation modus
5	Net value
6	Range display
7	Unity of displayed value
8	Tare and zero set button
9	Print button
10	Selection button REF quantity
11	Confirmation button for REF formation
12	Menu button (memory locations)
13	„Switch-off“ button
14	Weighing stoppage
15	Zeroing display
16	Piece weight
17	Info line for operator, article, etc.
18	Ref quantity

Select Operating mode in basic settings Nr.G14/2

Counting

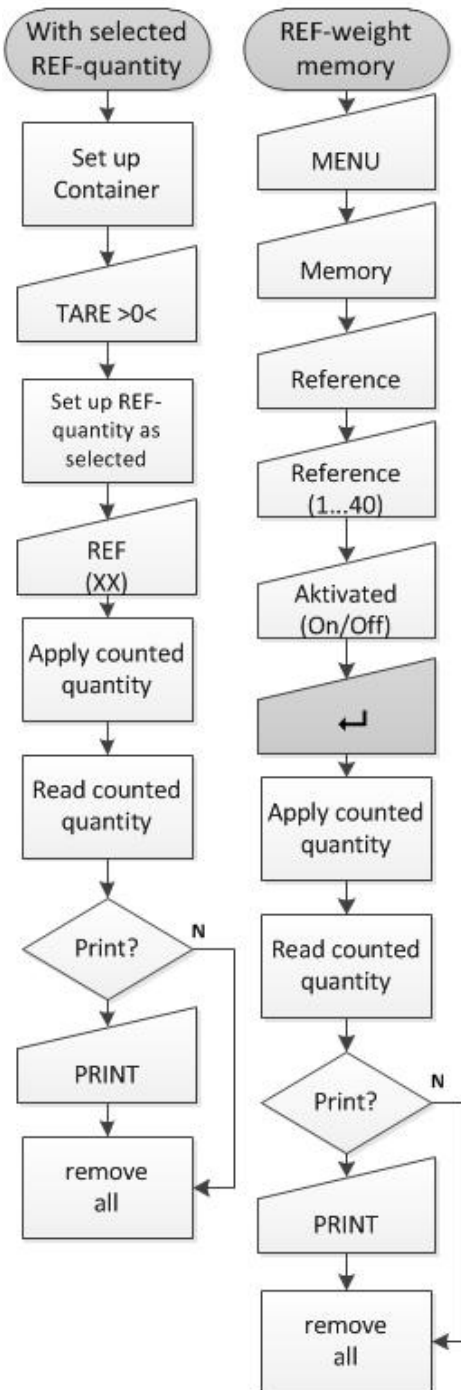

Before setting Counting

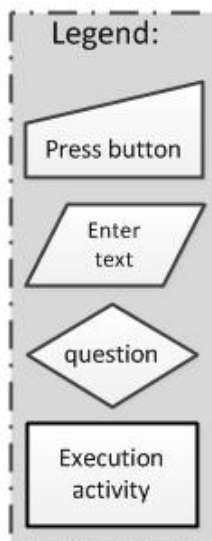
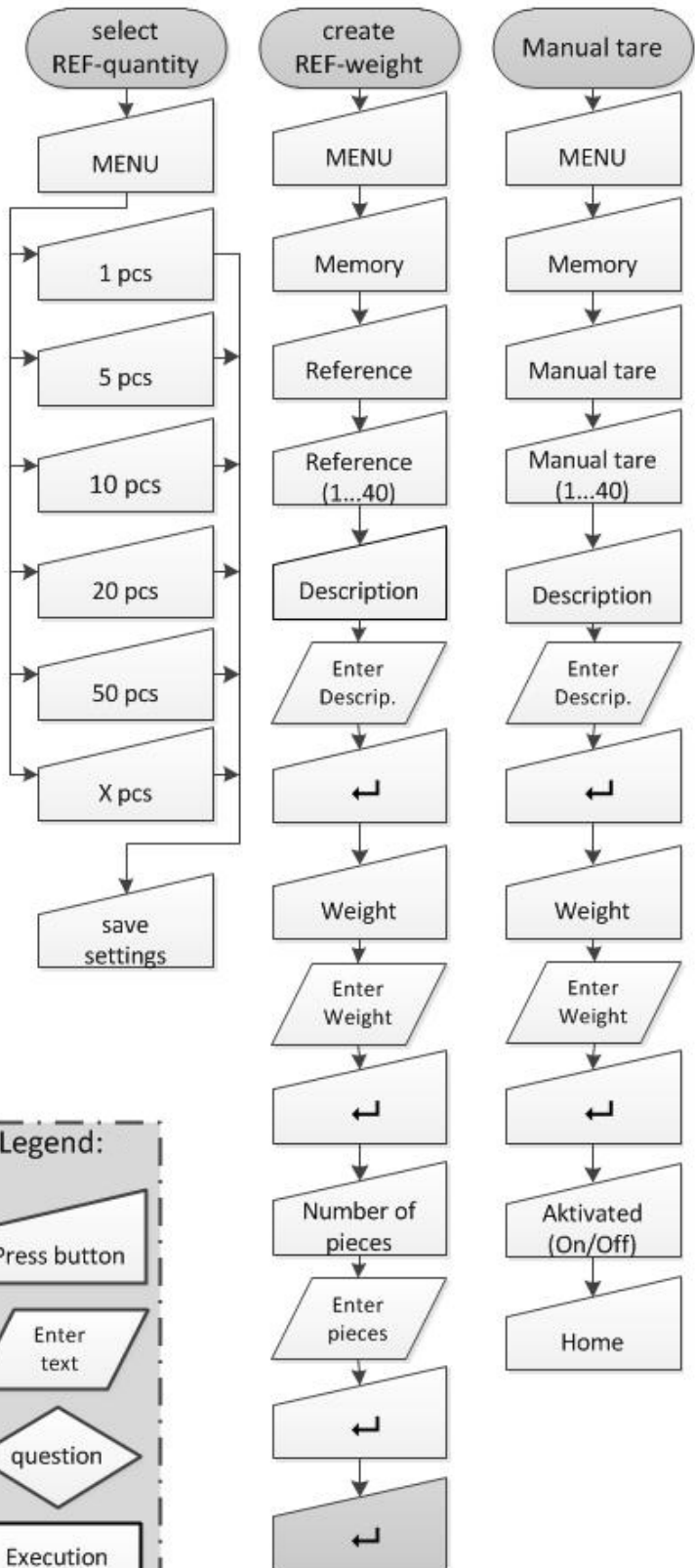

6.4 Screen Operating mode Totalizing

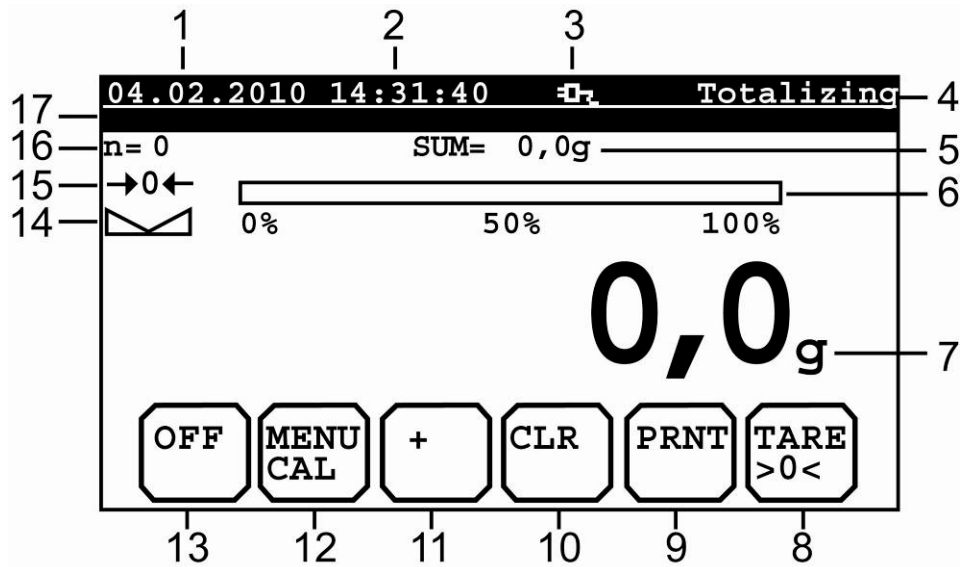

Display	Designation
1	Date
2	Time
3	Battery or mains operation
4	Operation modus
5	Sum value
6	Range display
7	Unity of displayed value
8	Tare and zero set button
9	Print button
10	Delete key
11	Addition button
12	Menu button (memory locations)
13	„Switch-off“ button
14	Weighing stoppage
15	Zeroing display
16	Number of positions
17	Info line for operator, article, etc.

Select Operating mode in basic settings Nr.G14/3

Totalizing

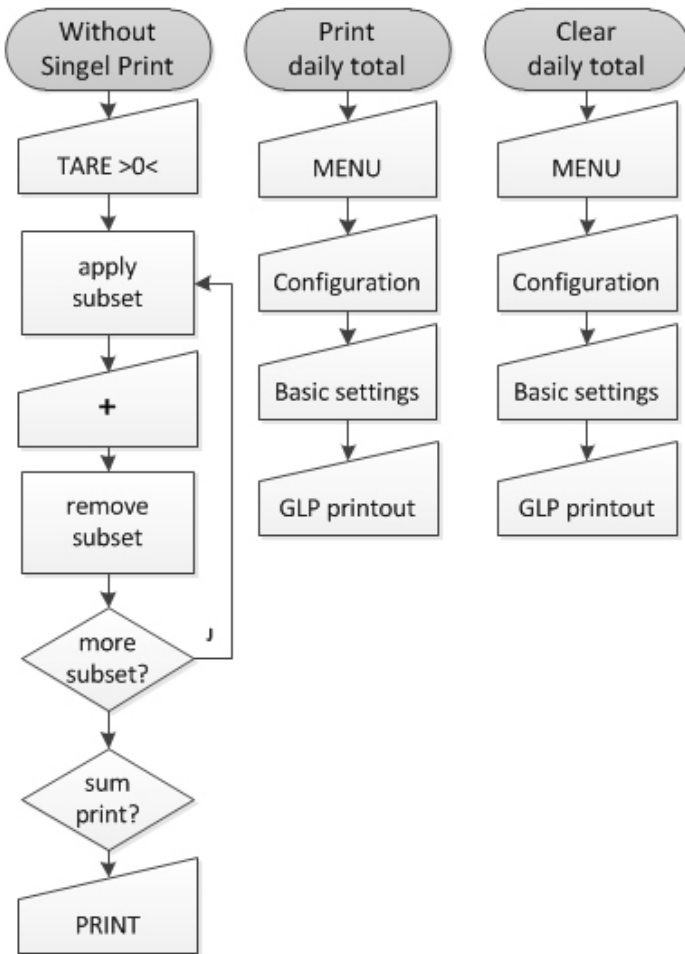

Before setting Totalizing

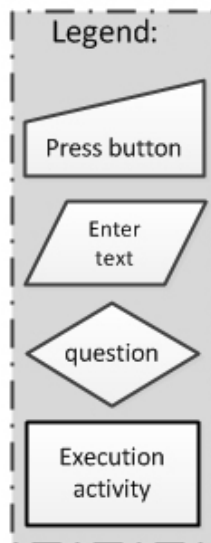
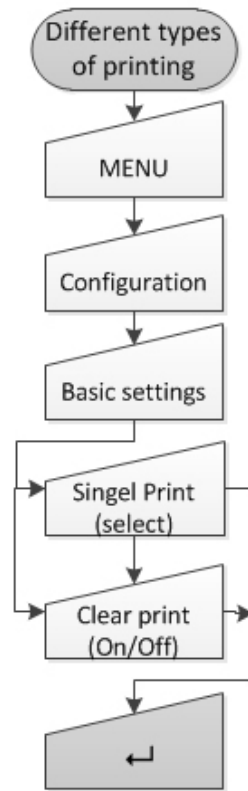

6.5 Screen Operating mode Dispensing

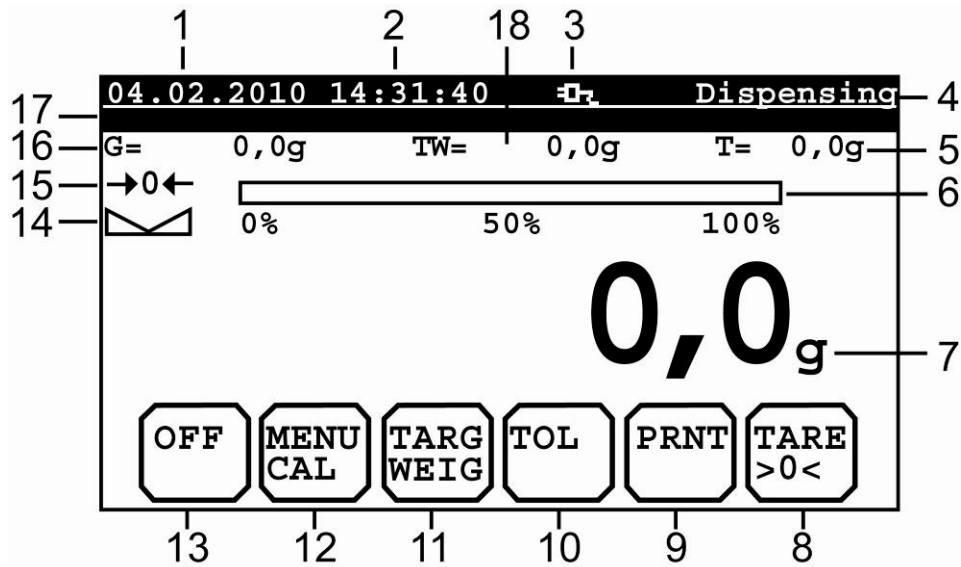

Display	Designation
1	Date
2	Time
3	Battery or mains operation
4	Operation modus
5	Tare value
6	Range display for target weight
7	Unity of displayed value
8	Tare and zero set button
9	Print button
10	Tolerance default
11	Target weight input
12	Menu button (memory locations)
13	„Switch-off“ button
14	Weighing stoppage
15	Zeroing display
16	Gross value
17	Info line for operator, article, etc.
18	Target weight default

Select Operating mode in basic settings Nr.G14/7

Dispensing

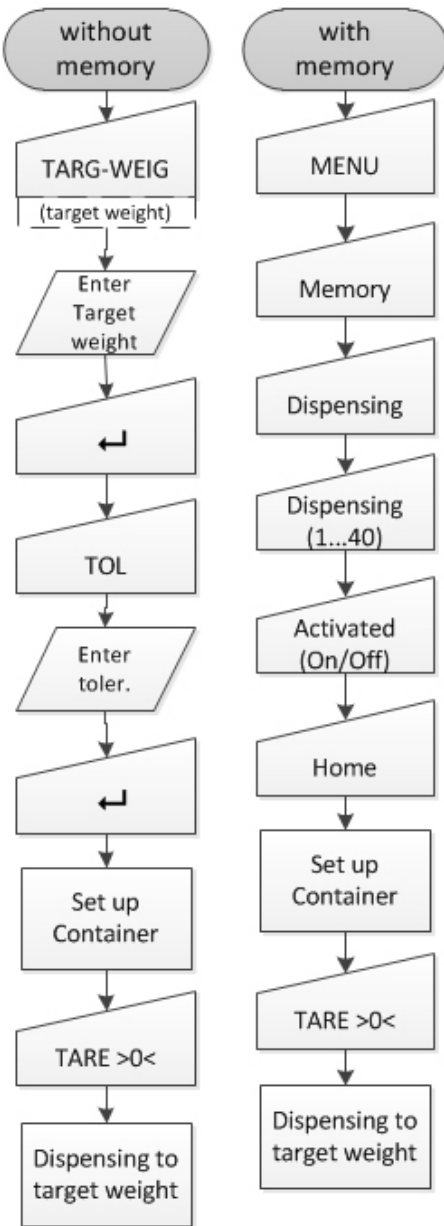

Before setting Dispensing

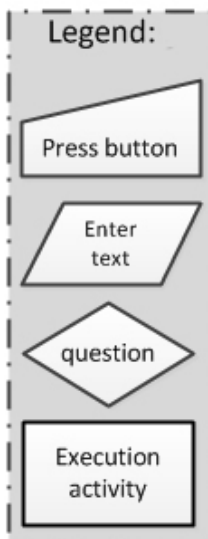
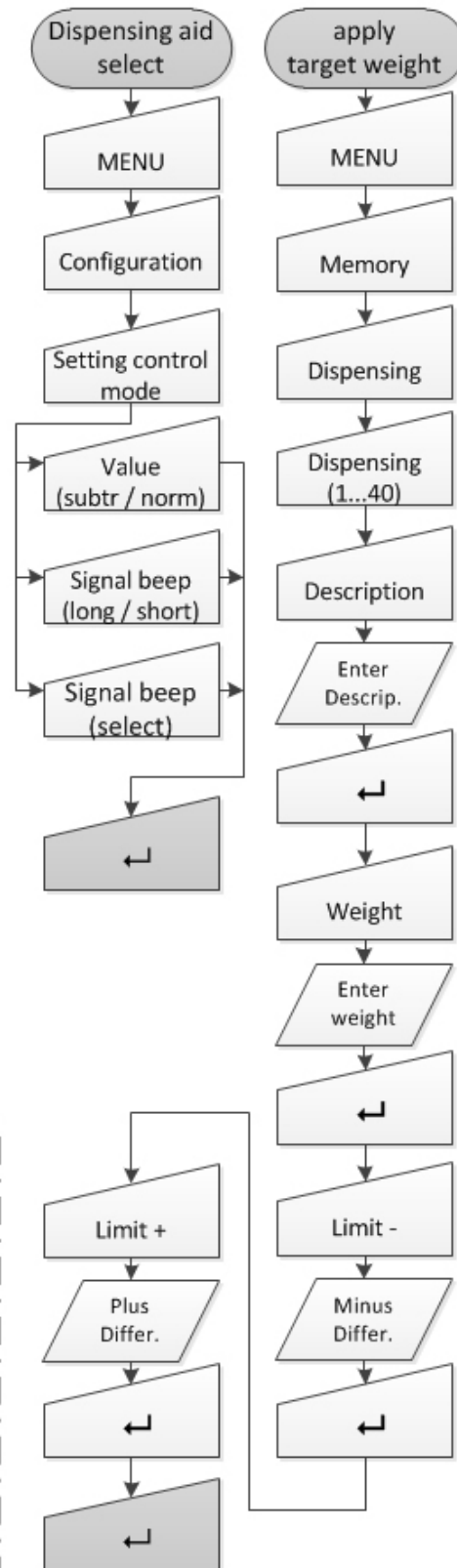

6.6 Screen Operating mode Check weighing

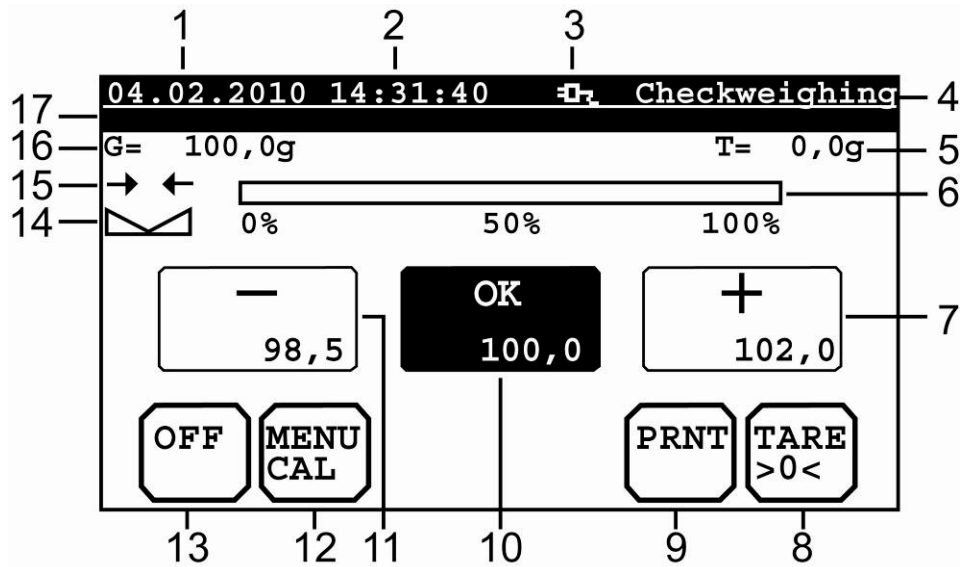

Display	Designation
1	Date
2	Time
3	Battery or mains operation
4	Operation modus
5	Tare value
6	Range display
7	Input / evaluation field plus-tolerance
8	Tare and zero set button
9	Print button
10	Input / evaluation field Setpoint value default
11	Input / evaluation field Minus-tolerance
12	Menu button (memory locations)
13	„Switch-off“ button
14	Weighing stoppage
15	Zeroing display
16	Gross value
17	Info line for operator, article, etc.

Select Operating mode in basic settings Nr.G14/5
Checkweighing

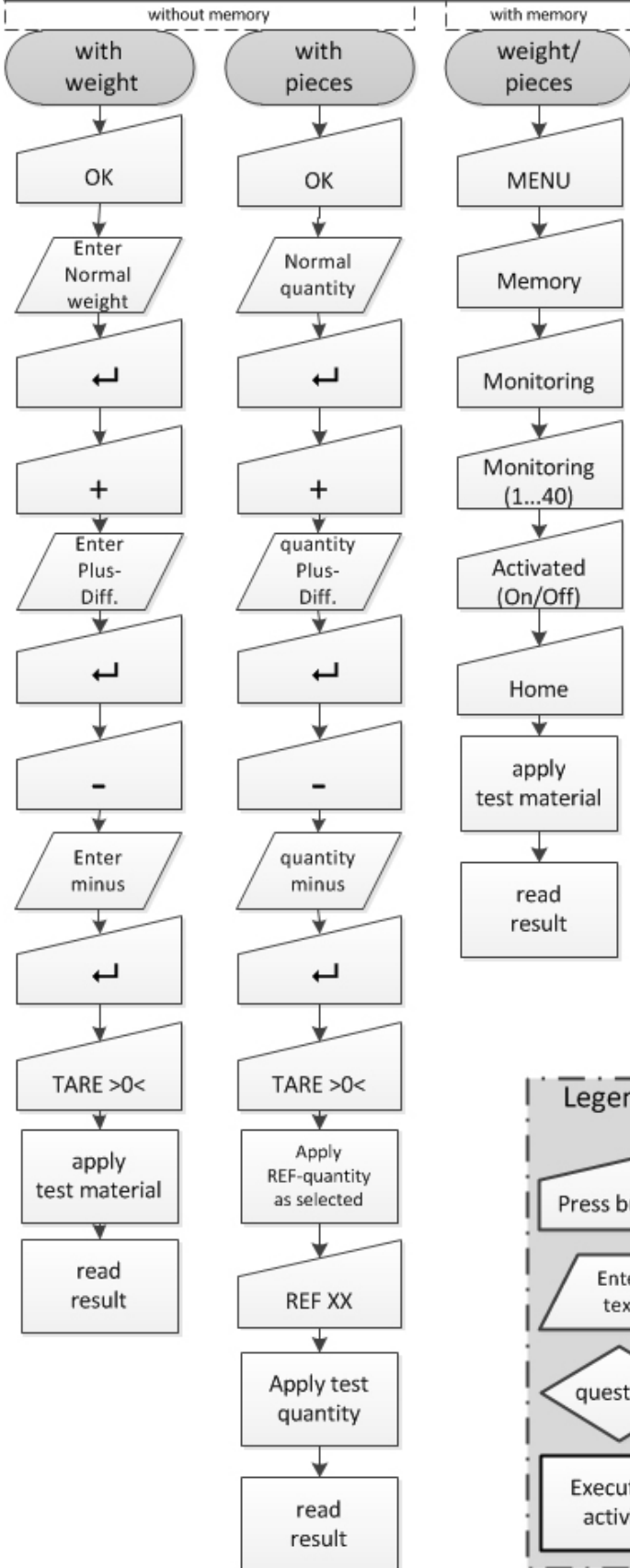

Basic setting
Checkweighing

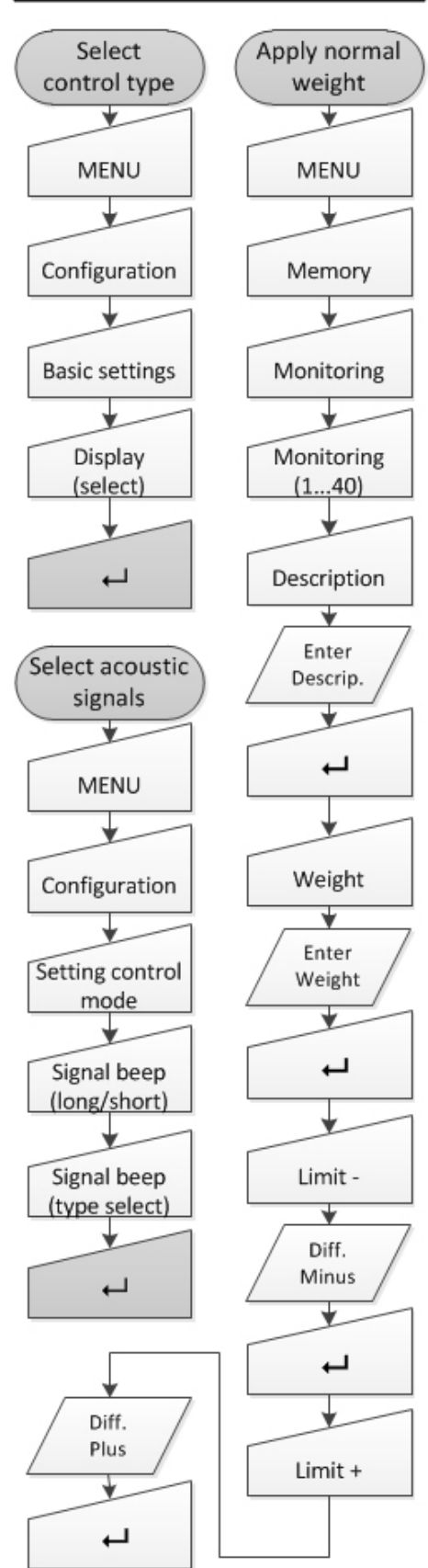

6.7 Screen Operating mode Percentage

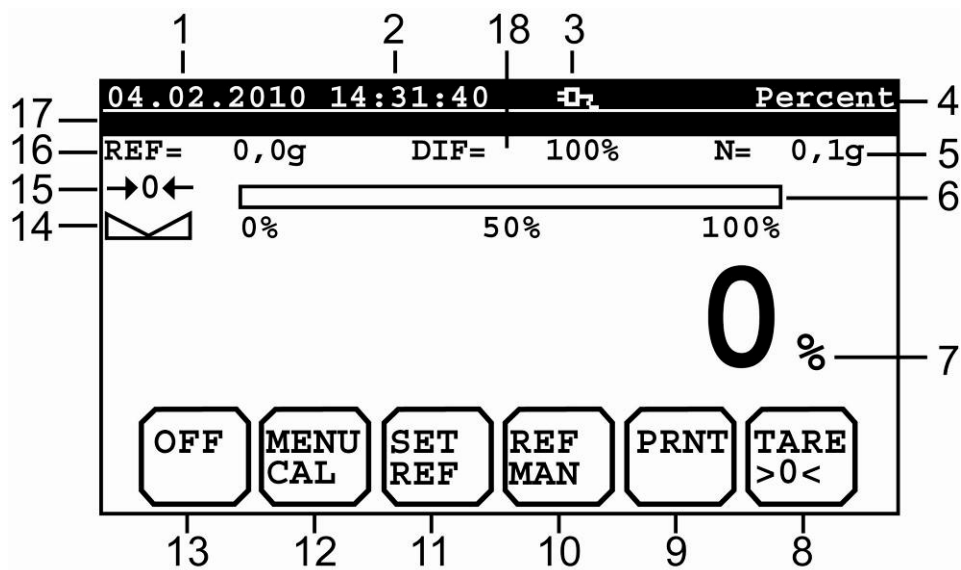

Display	Designation
1	Date
2	Time
3	Battery or mains operation
4	Operation modus
5	Net value
6	Range display
7	Unity of displayed value
8	Tare and zero set button
9	Print button
10	Input of REF weight
11	Confirmation of nominal weight
12	Menu button (memory locations)
13	„Switch-off“ button
14	Weighing stoppage
15	Zeroing display
16	REF weight
17	Info line for operator, article, etc.
18	Difference percentage

Select Operating mode in basic settings Nr.G14/6

Percent

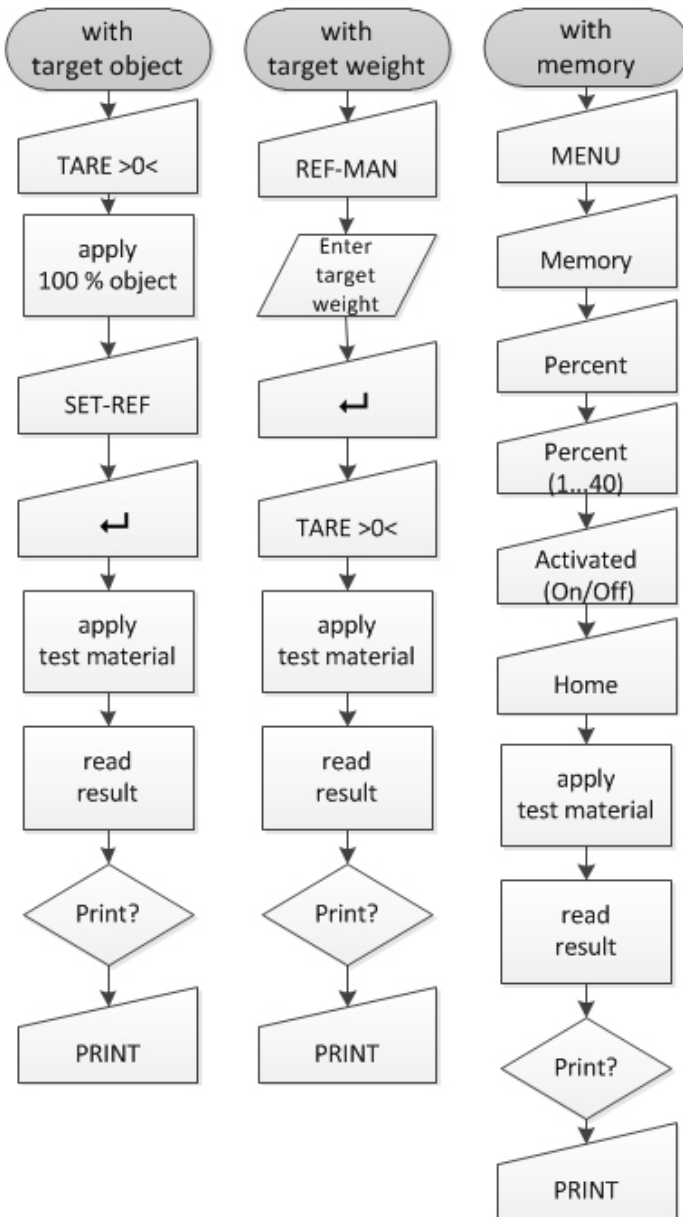

Before setting Percent

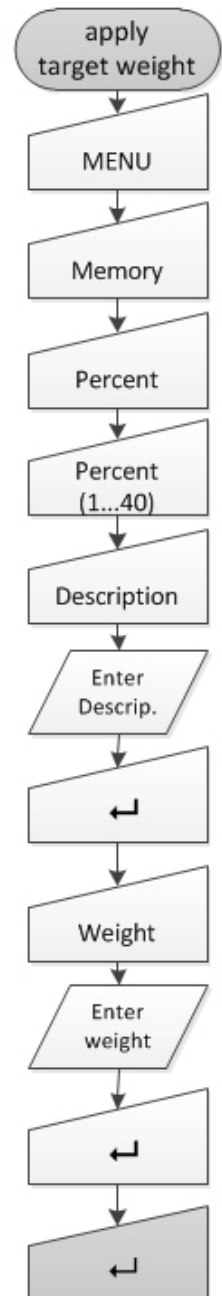

Legend:

Press button

Enter text

question

Execution activity

6.8 Screen Operating mode Animal weighing

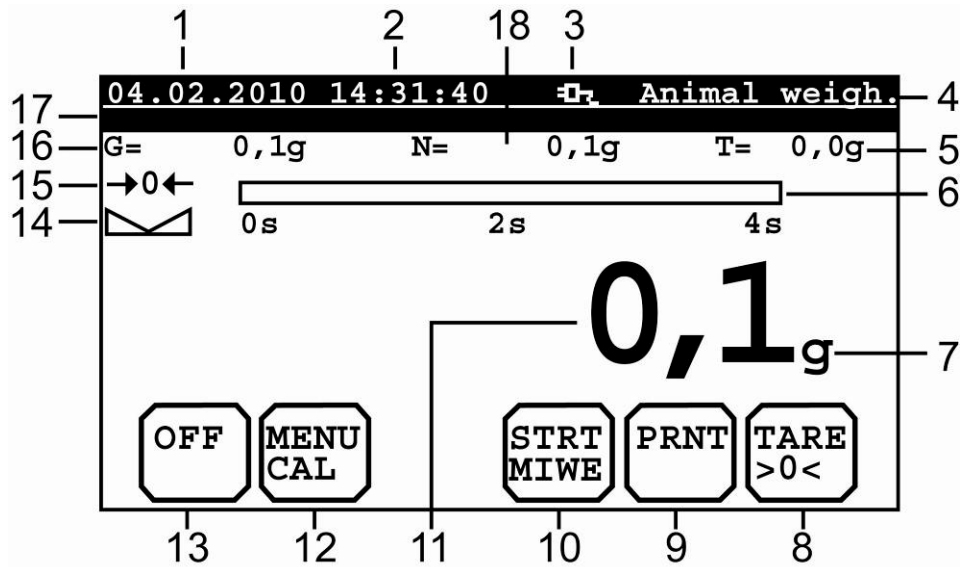

Display	Designation
1	Date
2	Time
3	Battery or mains operation
4	Operation modus
5	Tare value
6	Measuring period
7	Unity of displayed value
8	Tare and zero set button
9	Print button / deleting the mean value
10	Start measurement
11	Mean value for animal weighing
12	Menu button (memory locations)
13	„Switch-off“ button
14	Weighing stoppage
15	Zeroing display
16	Gross value
17	Info line for operator, article, etc.
18	Net value

Select Operating mode in basic settings Nr.G14/8

Animal weighing

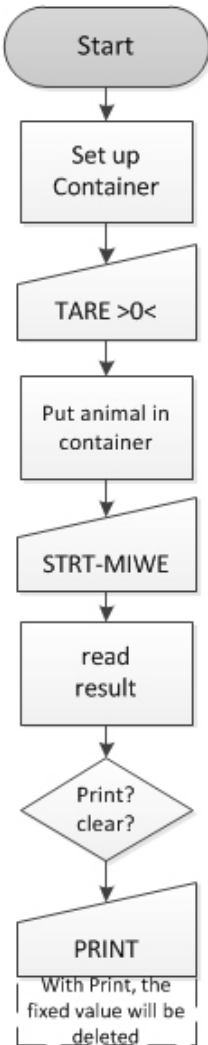

Before setting Animal weighing

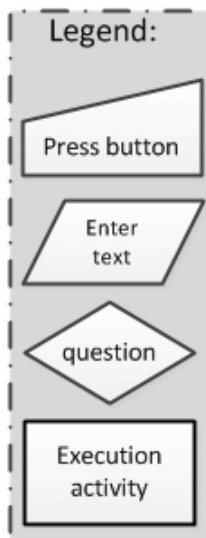
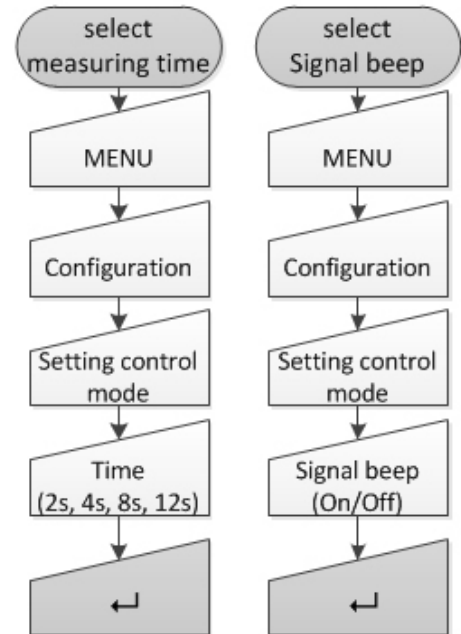

6.9 Screen Operating mode Formulation

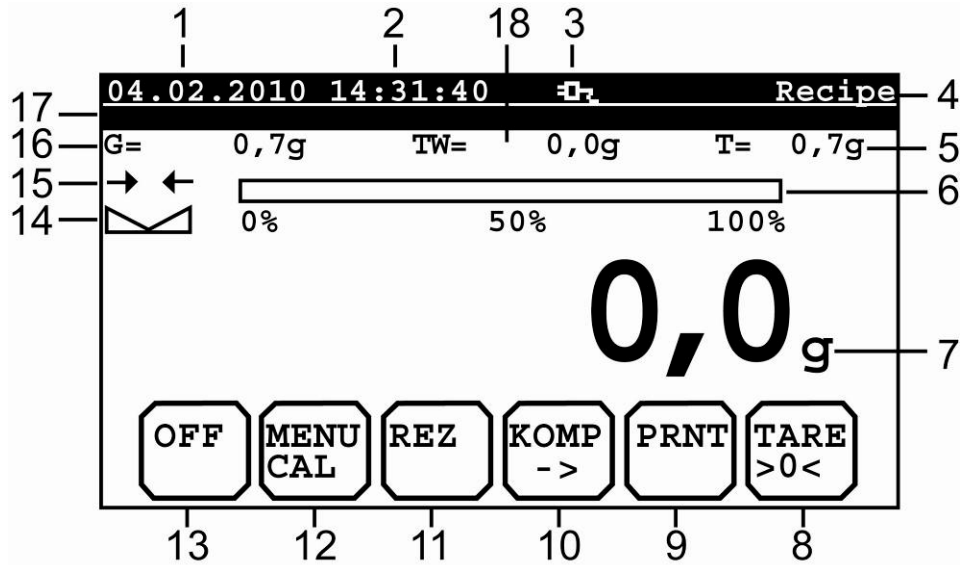

Display	Designation
1	Date
2	Time
3	Battery or mains operation
4	Operation modus
5	Tare value
6	Range display
7	Unity of displayed value
8	Tare and zero set button
9	Print button
10	Confirmation of component / Transfer of new target weight
11	Selection of formula
12	Menu button (memory locations)
13	„Switch-off“ button
14	Weighing stoppage
15	Zeroing display
16	Gross value
17	Info line for operator, article, etc.
18	Target weight default

Select Operating mode in basic settings Nr. G 14/4

Recipe

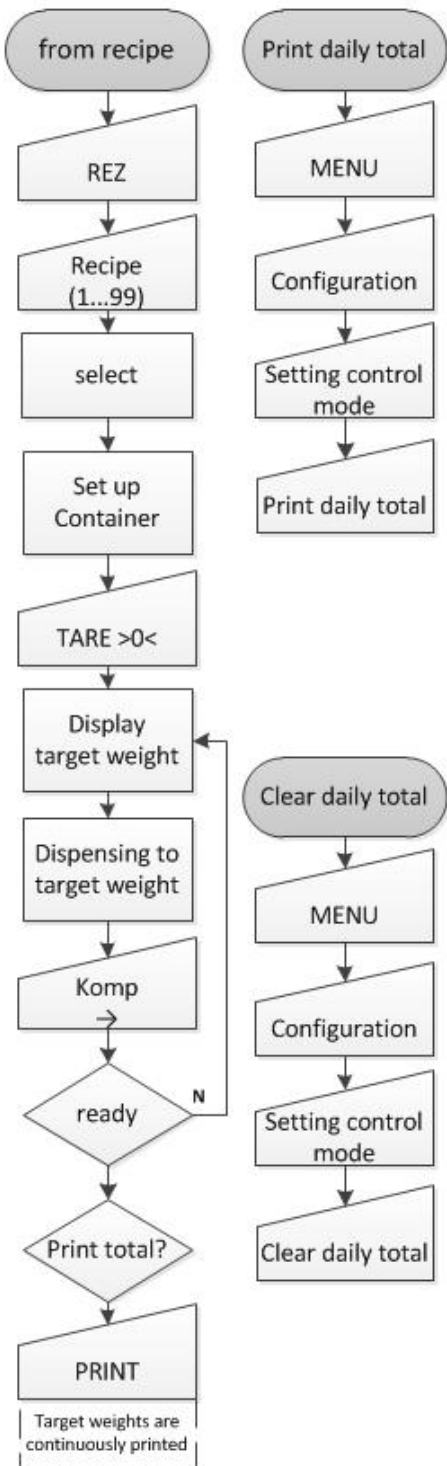

Basic setting Recipe SW: TE-1.00.10

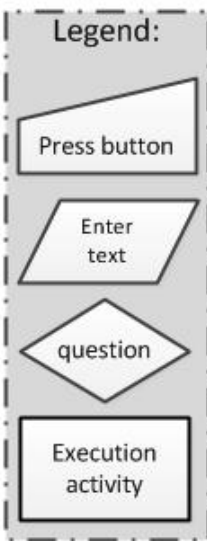
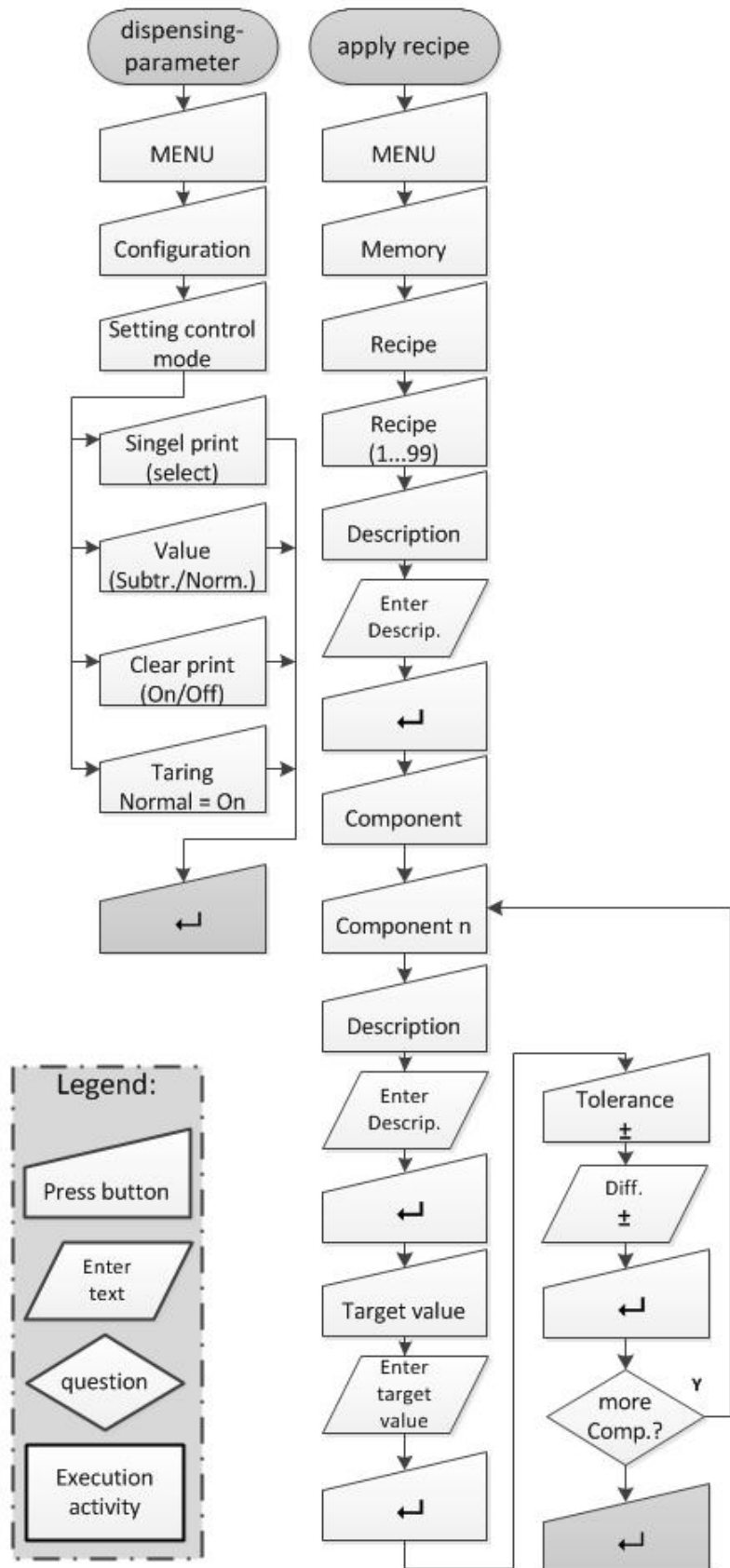

6.10 Screen Operating mode Surface weight

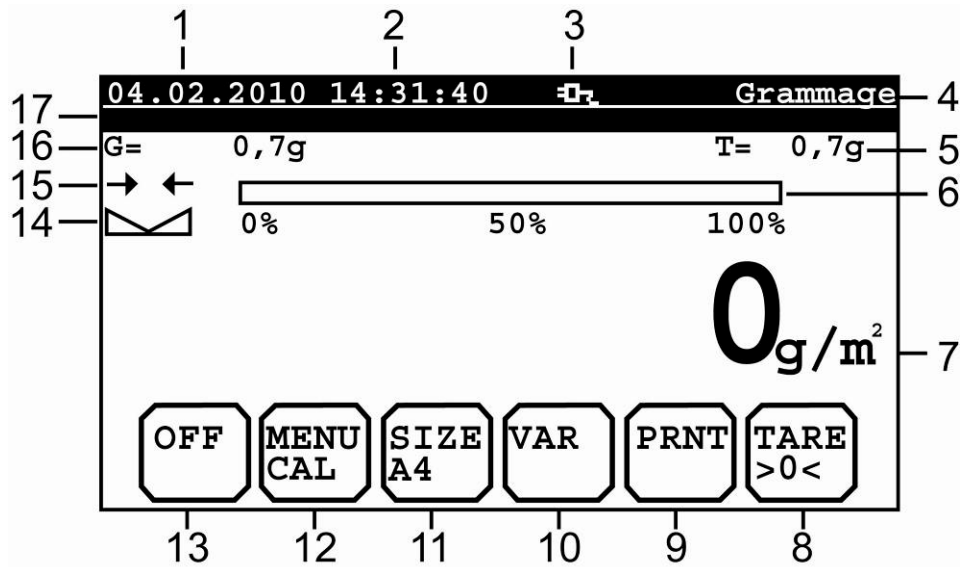

Display	Designation
1	Date
2	Time
3	Battery or mains operation
4	Operation modus
5	Tare value
6	Range display
7	Unity of displayed value
8	Tare and zero set button
9	Print button
10	Input of variable factor
11	Selection of paper format
12	Menu button (memory locations)
13	„Switch-off“ button
14	Weighing stoppage
15	Zeroing display
16	Gross value
17	Info line for operator, article, etc.

Select Operating mode in basic settings Nr.G14/9
Grammage

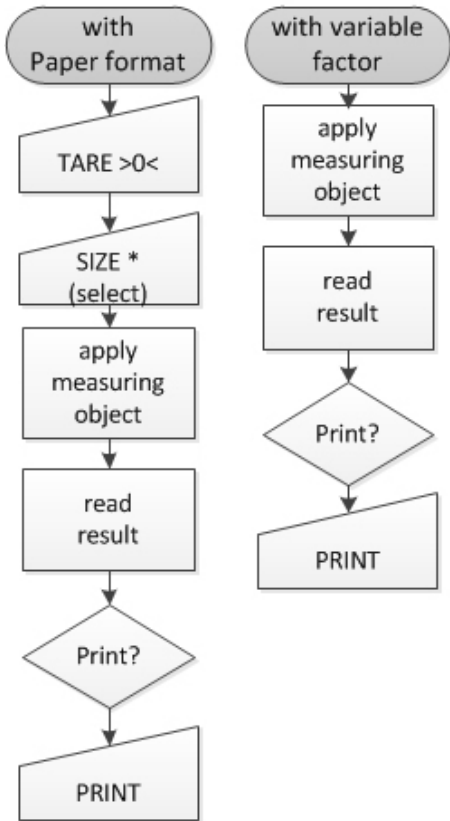

Basic setting Grammage

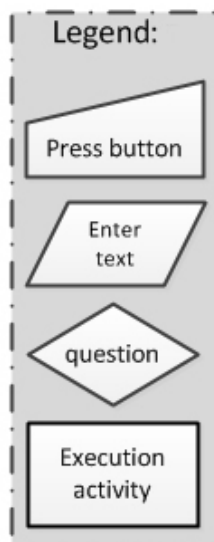
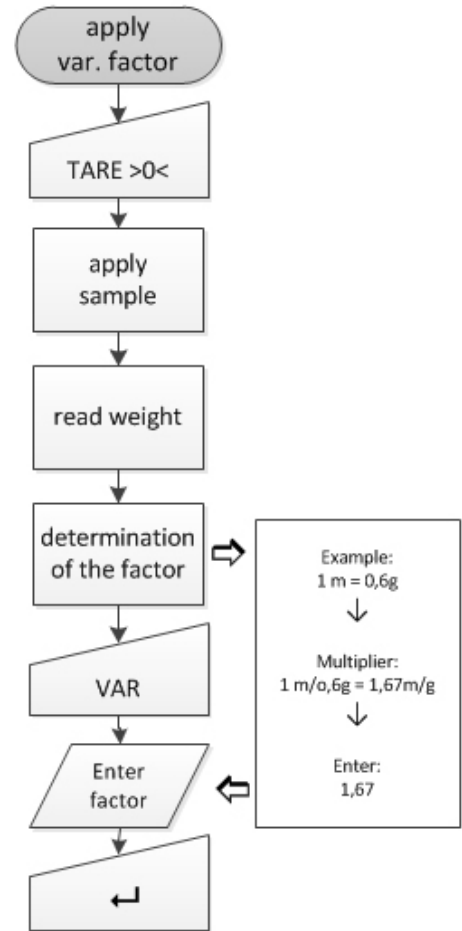

6.11 Screen Operating mode Density

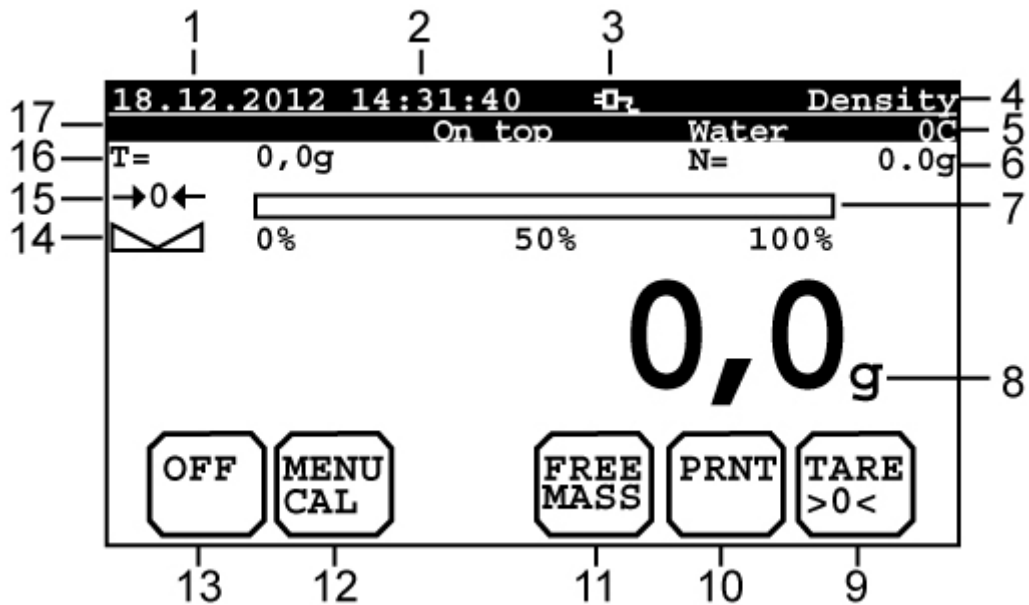

Display	Designation
1	Date
2	Time
3	Battery or mains operation
4	Operation modus
5	Test equipment / water temperature
6	Net value
7	Range display
8	Unity of displayed value
9	Tare and zero set button
10	Print button for printout and delete the density value
11	Button for reference confirmation
12	Menu button (memory locations)
13	„Switch-off“ button
14	Weighing stoppage
15	Zeroing display
16	Gross value
17	Info line for operator, article, etc.

Select Operating mode in basic settings Nr. G 14/10
- Only for balances with density set -

Density

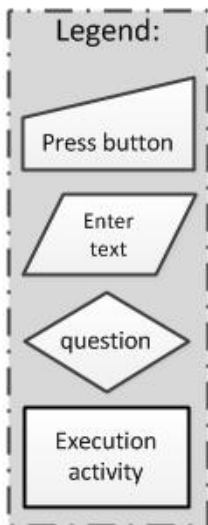
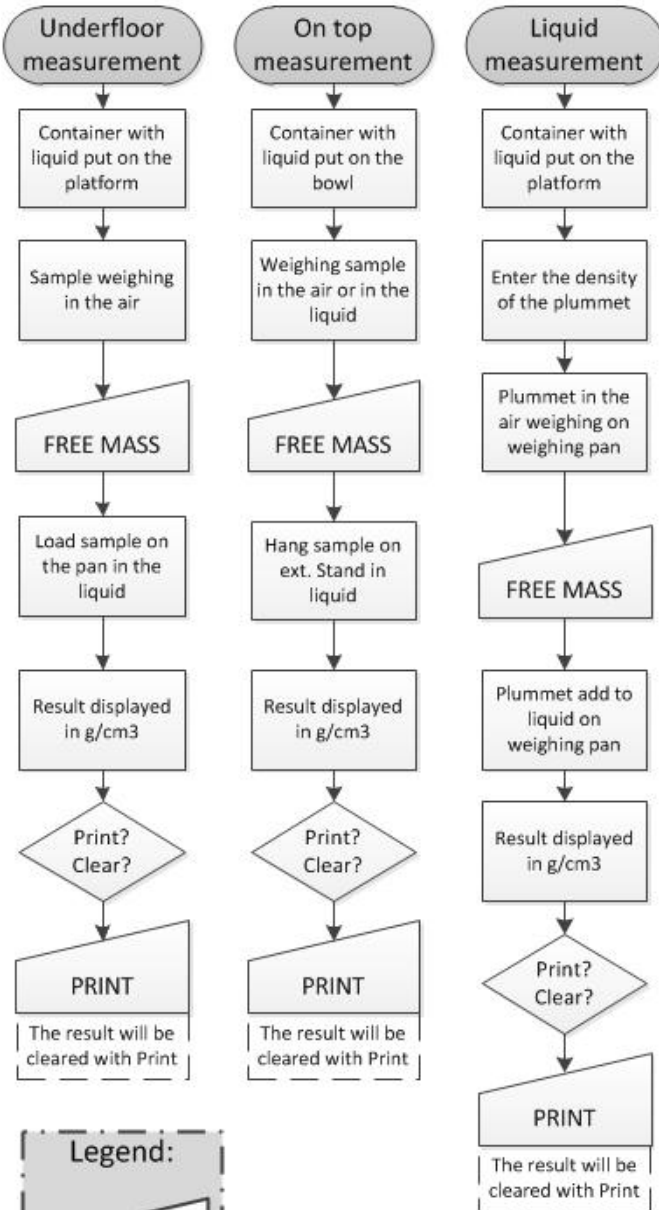

Basic setting Density

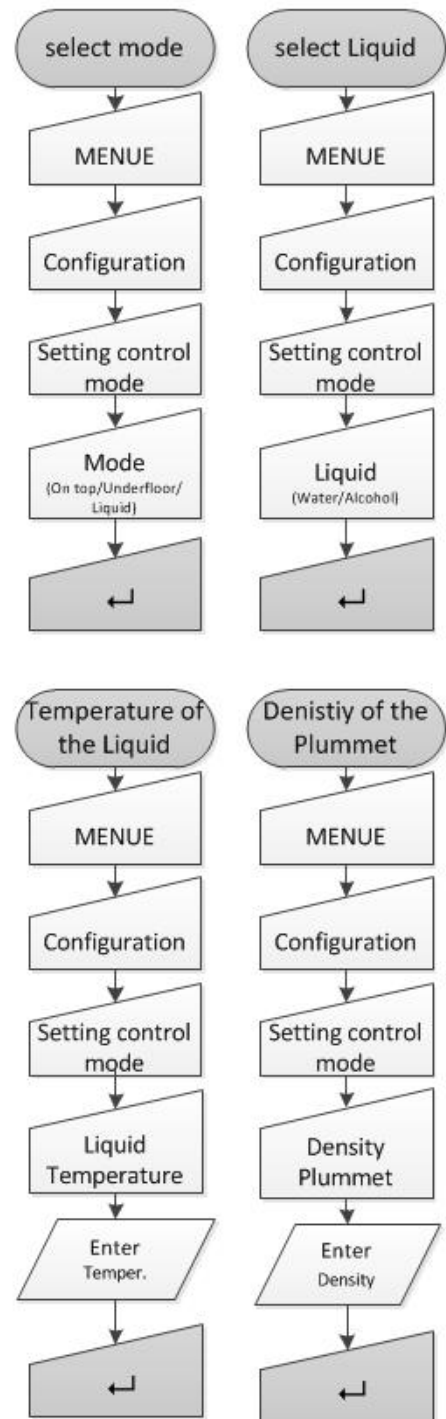

6.12 Forms

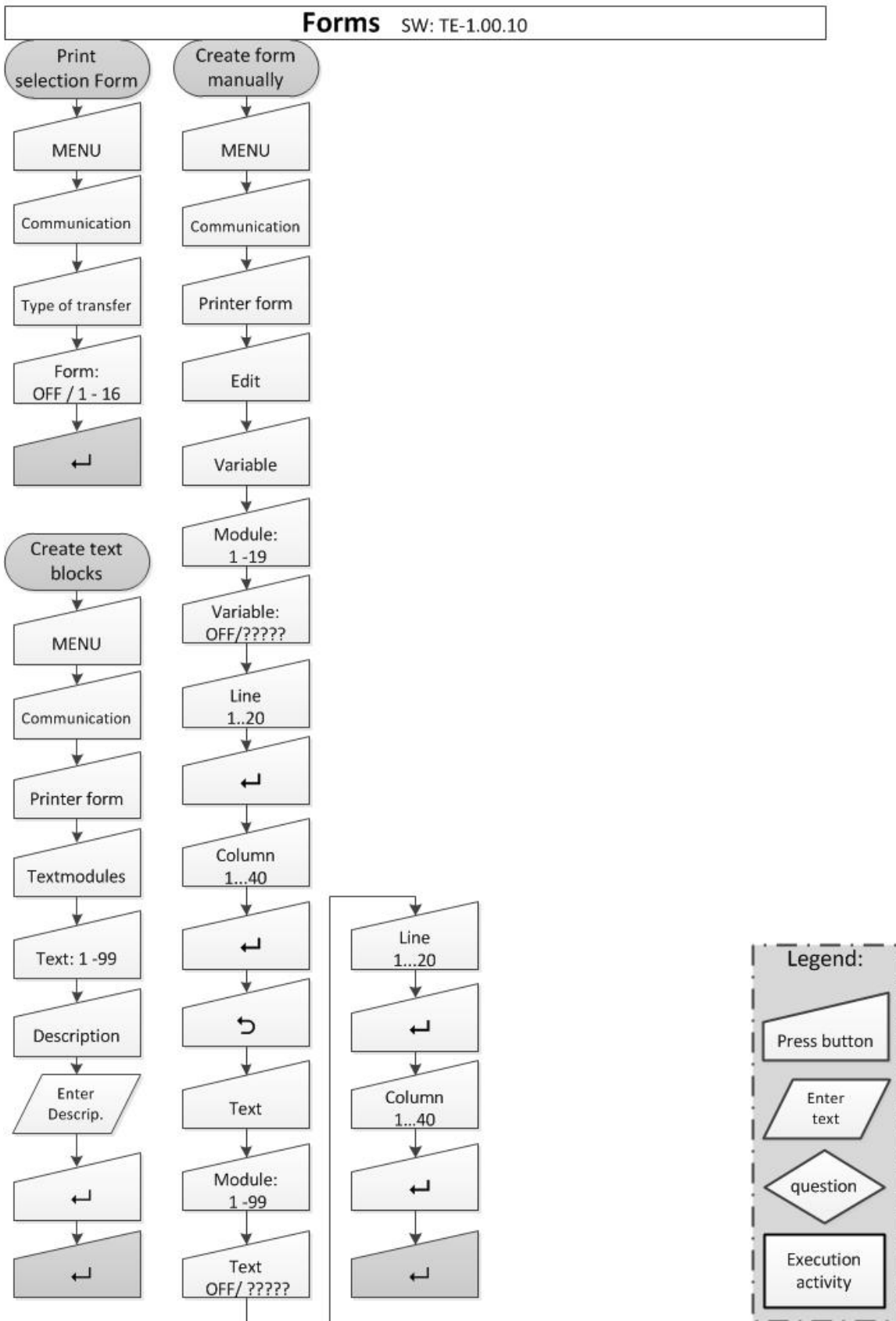

7 Print form

7.1 Contents of the form impression

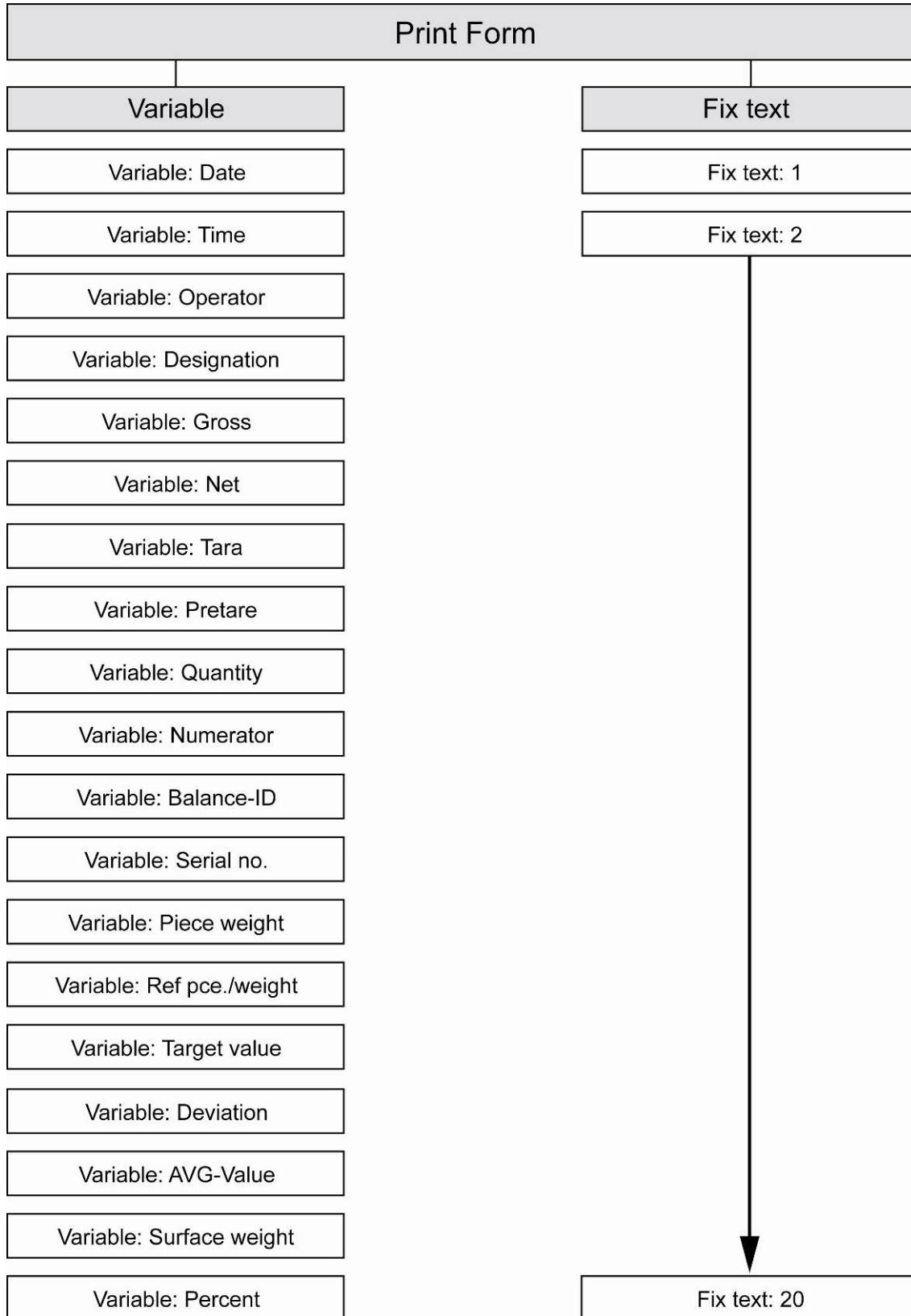

7.2 Arrangement of form printout

Variable	
Variable: Gross	Activated: ON
Line 2	Column 1
Printout "Gross" line 2 / column 1	xxxxxxxxxxxxxxxxxxxxxxxxxxxxxxxx 1. line 1500,00 g xxxxxxxxxxxxxxxx 2. line
Printout "Gross" line 2 / column 12	xxxxxxxxxxxxxxxxxxxxxxxxxxxxxxxx 1. line xxxxxxxxxxxxxxx1500,0 g xxxxxx 2. line
Fix text	
Fix text 1	Activated: ON
Line 2	Column 1
Designation „Gross“	
Printout "Designation contents" Line 2 / column 1	xxxxxxxxxxxxxxxxxxxxxxxxxxxxxxxx 1. line Gross : xxxxxxxxxxxxxxxxxxxxxxxx 2. line
Combination of fix text and variable	
Fix text "Gross:" -line 2 / column 1	xxxxxxxxxxxxxxxxxxxxxxxxxxxxxxxx 1. line Gross : xxx1500,0 g xxxxxx 2. line
Variable "gross value" – line 2 / column 12	

x = space character

- The fields „line“ and „column“ are position printing input fields
- Field „Variable“ is a selection field of fixed printing possibilities
- Field „Fix text“ offers the possibility to specify texts for printout.
- The field „designation“ is a text input field to add information such as gross, tare, net, pcs to the values.
- Field „Activated: on“ takes over this line into the print form.

8 Interfaces

8.1 Digital I/O output - open collectors (only model FKT/IKT)

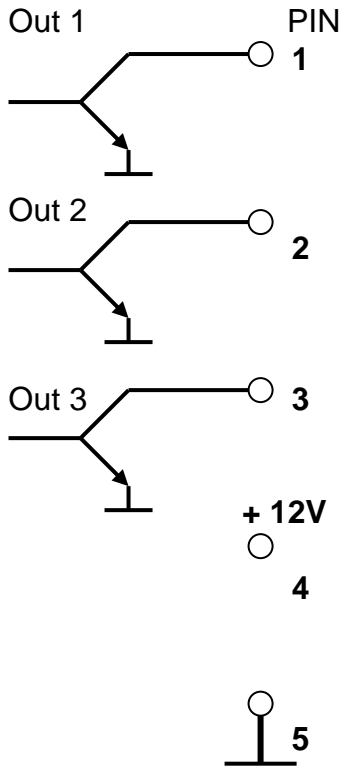

Diode connecting plug 5 pol.
Typ Masei 5100 S version D

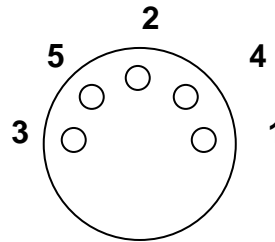

Performance data: $V_{cemax} = 35 \text{ V DC}$
 $I_{cmax} = 80 \text{ mA DC}$

Out 1 = Limit 1

Out 2 = Limit 2

Out 3 = Limit 3

8.2 Data output RS 232 C

Technical data:

8-bit ASCII Code

- 1 start bit, 8 data bits, 1 stop bit, no parity bit
- Baud rate selectable from 2400, 4800, 9600 Baud (factory setting) and 19200 Baud.
- Sub-D plug 9-channel required
- For operation with interface faultless operation is only ensured with the correct KERN – interface cable (max. 2m)

Pin allocation of the balance output socket (front view)

Sub-D jack 9-channel

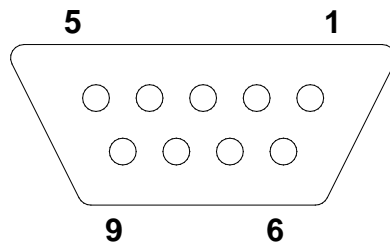

Pin 2: Transmit data

Pin 3: Receive data

Pin 5: Signal ground

8.3 Interface RS 232C

Data output via interface RS 232C

General

The previous condition for the data transfer between balance and a peripheral device (e.g. printer, PC ...) is that the appliances are set to the same interface parameters (e.g. baud rate, parity ...).

8.3.1 There are 4 kinds of data output via RS 232C

Data output using the PRINT key

The printing process can be triggered by pressing the PRINT key.

The settings AUTOPRINT and AUTOPRINT should be disabled for this process.

AUTOPRINT (data output according to weight application)

The setting AUTOPRINT is located on the PRINTER path where you can turn it on or off. When AUTOPRINT is active, the current weighing value will be sent via the RS 232 data interface after unloading and subsequent loading of the balance as soon as the balance is in resting position.

Permanent PRINT (continuous data output)

The setting permanent Print is located on the PRINTER path and where you can turn it on or off. When permanent Print is active, the current weighing values will be sent continuously via the RS 232 data interface.

Data output and remote control commands

Remote control commands transferred as ASCII characters to the balance can be used to trigger the following functions on the balance (always finish with CR, LF!):

- t Taring
- w The balance sends a weighing value (also unstable) via the serial interface.
- s The balance sends a stable weighing value via the serial interface.

After receiving either character w or s, the balance will send without a printer pause between the characters.

8.3.2 Explanation of the data transfer

Each data transfer is structured as follows:

Bit.Nr.	1	2	3	4	5	6	7	8	9	10	11	12	13	14	15	16	17	18	19	20
	N	N	N	N	N	B	B	B	B	B	B	B	B	B	B	B	0	•	0	0

Bit.Nr.	21	22	23	24	25	26
	E	E	E	E	CR	LF

- N = Numerator
- B*: = Blank or for autotare on in zero range.
- B, 0, ;, g: = Blank or weighing value giving unit according to loading of the balance
- E = Unit
- CR: = Carriage Return
- LF: = Line Feed

8.4 Printer

The serial interface RS 232 facilitates the connection of a printer. The printout shows the weight in grams. In counting mode either the piece number or the weight details will be printed out.

In percentage mode the percentage proportion or the weight details will be printed out.

Printout will take place after pressing the PRINT key.

It is possible to number each printout continuously with the help of the numerator.

The numerator will be reset to (000) each time the balance is turned off or the CLEAR function is actuated.

8.5 Underfloor weighing

Objects which are unsuitable for placement on the weighing tray due to their size or shape can be weighed with the help of the underfloor weighing facility.

Proceed as follows:

- Switch off balance.
- Turn over the balance and in doing so take care that the weighing plate is not loaded.
- Open the closing lid on the bottom of your balance.
- Mount the hooks for underfloor weighing.
- Put the balance over an opening
- Suspend the goods to be weighed from the hook and carry out the weighing.



CAUTION

- Always ensure that all suspended objects are stable enough to hold the desired goods to be weighed safely (danger of breaking).
- Never suspend loads that exceed the stated maximum load (max) (danger of breaking)
- Always ensure that there are no persons, animals or objects that might be damaged underneath the load.



After completing the underfloor weighing the opening on the bottom of the balance must always be closed (dust protection).

9 Service, maintenance, disposal

9.1 Cleaning

Before cleaning, please disconnect the appliance from the operating voltage.

Please do not use aggressive cleaning agents (solvents or similar agents), but a cloth dampened with mild soap suds. Ensure that no liquid penetrates into the device and wipe with a dry soft cloth. Loose residue sample/powder can be removed carefully with a brush or manual vacuum cleaner.

Spilled weighing goods must be removed immediately.

9.2 Service, maintenance

The appliance may only be opened by trained service technicians who are authorized by KERN. Before opening, disconnect from power supply.

9.3 Disposal

Disposal of packaging and appliance must be carried out by operator according to valid national or regional law of the location where the appliance is used.

10 Instant help

In case of an error in the program process, briefly turn off the balance and disconnect from power supply. The weighing process must then be restarted from the beginning.

Help:

Fault

Possible cause

The displayed weight does not glow.

- The balance is not switched on.
- The mains supply connection has been interrupted (mains cable not plugged in/faulty).
- Power supply interrupted.

The displayed weight is permanently changing

- Draught/air movement
- Table/floor vibrations
- Weighing plate has contact with other objects.
- Electromagnetic fields / static charging (choose different location/switch off interfering device if possible)

The weighing value is obviously wrong

- The display of the balance is not at zero
- Adjustment is no longer correct.
- Great fluctuations in temperature.
- Electromagnetic fields / static charging (choose different location/switch off interfering device if possible)

Should other error messages occur, switch balance off and then on again. If the error message remains inform manufacturer.

11 Declaration of conformity



KERN & Sohn GmbH

D-72322 Balingen-Frommern

Postfach 4052

E-Mail: info@kern-sohn.de

Tel: 0049-[0]7433- 9933-0

Fax: 0049-[0]7433-9933-149

Internet: www.kern-sohn.de

Declaration of conformity

EC-Konformitätserklärung
EC- Déclaration de conformité
EC-Dichiarazione di conformità
EC- Declaração de conformidade
EC-Deklaracja zgodności

EC-Declaration of -Conformity
EC-Declaración de Conformidad
EC-Conformiteitverklaring
EC- Prohlášení o shode
ЕС-Заявление о соответствии

D	Konformitäts- erklärung	Wir erklären hiermit, dass das Produkt, auf das sich diese Erklärung bezieht, mit den nachstehenden Normen übereinstimmt.
GB	Declaration of conformity	We hereby declare that the product to which this declaration refers conforms with the following standards.
CZ	Prohlášení o shode	Tímto prohlašujeme, že výrobek, kterého se toto prohlášení týká, je v souladu s níže uvedenými normami.
E	Declaración de conformidad	Manifestamos en la presente que el producto al que se refiere esta declaración está de acuerdo con las normas siguientes
F	Déclaration de conformité	Nous déclarons avec cela responsabilité que le produit, auquel se rapporte la présente déclaration, est conforme aux normes citées ci-après.
I	Dichiarazione di conformità	Dichiariamo con ciò che il prodotto al quale la presente dichiarazione si riferisce è conforme alle norme di seguito citate.
NL	Conformiteit- verklaring	Wij verklaren hiermede dat het product, waarop deze verklaring betrekking heeft, met de hierna vermelde normen overeenstemt.
P	Declaração de conformidade	Declaramos por meio da presente que o produto no qual se refere esta declaração, corresponde às normas seguintes.
PL	Deklaracja zgodności	Niniejszym oświadczamy, że produkt, którego niniejsze oświadczenie dotyczy, jest zgodny z poniższymi normami.
RUS	Заявление о соответствии	Мы заявляем, что продукт, к которому относится данная декларация, соответствует перечисленным ниже нормам.

Electronic Balance: KERN FKT / IKT / PKT

EU Directive	Standards
2004/108/EC	EN 55011: 2009/A1:2010 EN 55022: 2010/AC:2011 EN 61000-3-2 :2006-04 + A1 : 2009 + A2 : 2009 EN61000-3-3 :2008 EN 55024: 2010 EN45501 :1992-10+AC :1993-08 OIML R 76-1 :2006
2006/95/EC	EN60950

Datum 08.04.2013
Date

Ort der Ausstellung 72336 Balingen
Place of issue

Signatur
Signature

Albert Sauter
KERN & Sohn GmbH
Geschäftsführer
Managing director

KERN & Sohn GmbH, Ziegelei 1, D-72336 Balingen, Tel. +49-[0]7433/9933-0
Fax +49-[0]7433/9933-149, E-Mail: info@kern-sohn.com, Internet: www.kern-sohn.com