

Data sheet | Item number: 2006-8671

2-conductor disconnect/test terminal block; with pivoting knife disconnect; with test option; orange disconnect link; for DIN-rail 35 x 15 and 35 x 7.5; 6 mm²; Push-in CAGE CLAMP®

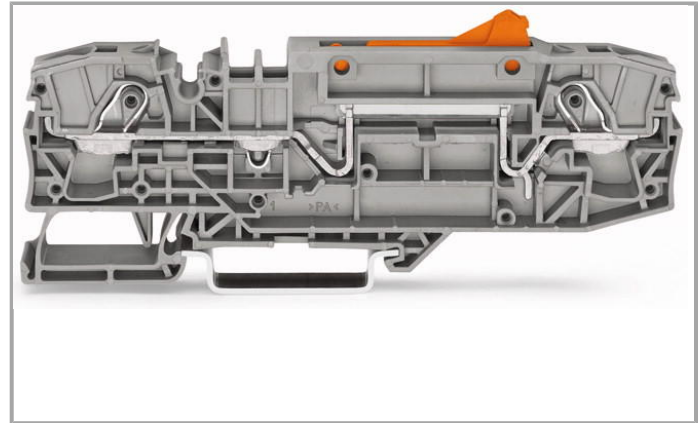

www.wago.com/2006-8671

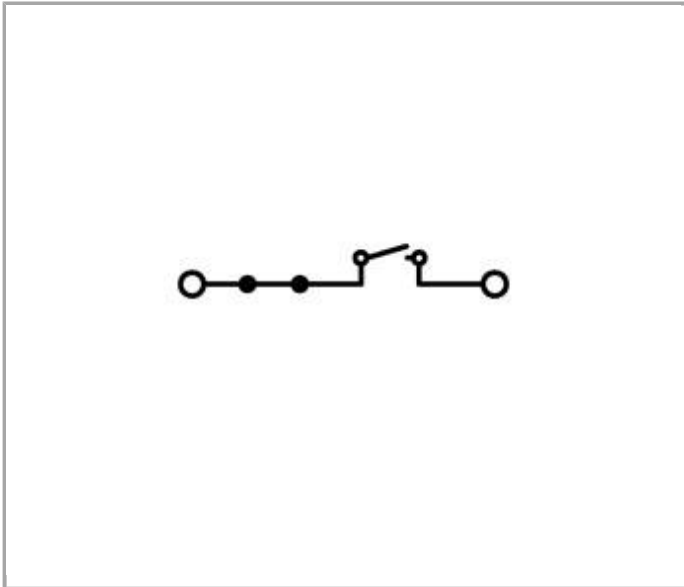
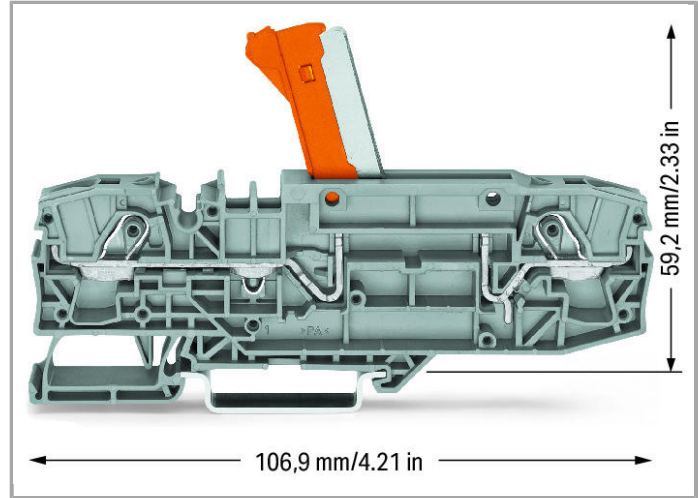
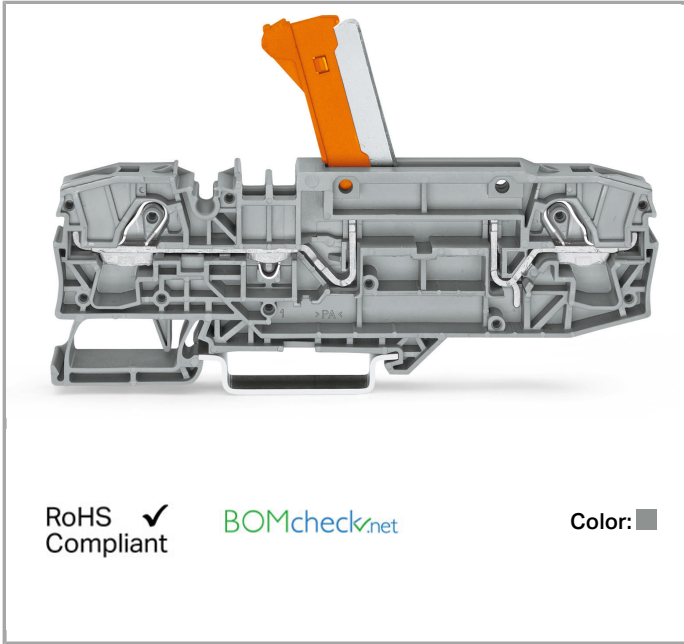

Data

Electrical data

Voltage type (1)

AC/DC

Ratings per IEC/EN 60664-1

Rated voltage (III / 3)

1000 V



Rated impulse voltage (III / 3)	12 kV
Rated current	30 A
Rated voltage (III / 3) 2	1500 V
Rated impulse voltage (III / 3) 2	12 kV
Legend (ratings)	(III / 3) $\hat{=}$ Overvoltage category III / Pollution degree 3

Approvals per UL 1059

Rated voltage UL (Use Group B)	600 V
Rated current UL (Use Group B)	30 A
Rated voltage UL (Use Group C)	600 V
Rated current UL (Use Group C)	30 A

Approvals per CSA

Rated voltage CSA (Use Group B)	600 V
Rated current CSA (Use Group B)	30 A
Rated voltage CSA (Use Group C)	1000 V
Rated current CSA (Use Group C)	30 A

Connection data

Connection technology	Push-in CAGE CLAMP®
Actuation type	Push-in Operating tool
Connectable conductor materials	Copper
Nominal cross section	6 mm ²
Solid conductor	0.5 ... 10 mm ² / 20 ... 8 AWG
Solid conductor, push-in termination	2.5 ... 10 mm ² / 14 ... 8 AWG
Fine-stranded conductor	0.5 ... 10 mm ² / 20 ... 8 AWG
Fine-stranded conductor with ferrule, push-in termination, from	2.5 mm ² / 16 AWG
Strip length	13 ... 15 mm / 0.51 ... 0.59 Inch
Total number of connection points	2
Total number of potentials	1
Number of levels	1
Type of wiring	Front-entry wiring

Geometrical Data

Width	15 mm / 0.591 inch
Height from upper-edge of DIN-35 rail	33 mm / 1.299 inch
Depth	106.9 mm / 4.209 inch

Mechanical data

Design	horizontal
Type of mounting	DIN-35 rail
Marking level	Center/side marking

Material Data

Color	gray
Insulating material	Polyamide 66 (PA 66)
Fire load	0.673 MJ
Weight	31.425 g

Commercial data

Country of origin	DE
GTIN	4050821372509
Customs Tariff No.	85365080990
Product Group	22 (TOPJOB S)

Approvals / Certificates

Country specific Approvals

Logo	Approval	Certificate name
	CCA DEKRA Certification B.V.	NTR NL 7311
	CCA DEKRA Certification B.V.	71-101179

Ship Approvals

Logo	Approval	Certificate name
	ABS American Bureau of Shipping	14-HG1293677-PDA

UL-Approvals

Logo	Approval	Certificate name
	UL Underwriters Laboratories Inc.	E45172

Compatible products

Jumper



Item no.: 2006-433
Push-in type jumper bar; insulated; from 1 to 3; Nominal current 41 A

www.wago.com/2006-433



Item no.: 2006-435
Push-in type jumper bar; insulated; from 1 to 5; Nominal current 41 A

www.wago.com/2006-435



Item no.: 210-103
Wire commoning chain; insulated; 50 connections

www.wago.com/210-103

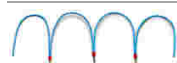

Item no.: 210-123
Wire commoning chain; insulated; 50 connections

www.wago.com/210-123

Marking accessories



Item no.: 2009-110
Marking strips; on reel; not stretchable; plain; snap-on type

www.wago.com/2009-110



Item no.: 2009-115
WMB-Inline; for smartPRINTER; on reel; stretchable 5 - 5.2 mm; plain; snap-on type

www.wago.com/2009-115



Item no.: 2009-115/000-002
WMB-Inline; for smartPRINTER; on reel; stretchable 5 - 5.2 mm; plain; snap-on type

www.wago.com/2009-115/000-002



Item no.: 2009-115/000-006
WMB-Inline; for smartPRINTER; on reel; stretchable 5 - 5.2 mm; plain; snap-on type

www.wago.com/2009-115/000-006



Item no.: 2009-115/000-007
WMB-Inline; for smartPRINTER; on reel; stretchable 5 - 5.2 mm; plain; snap-on type

www.wago.com/2009-115/000-007



Item no.: 2009-115/000-012
WMB-Inline; for smartPRINTER; on reel; stretchable 5 - 5.2 mm; plain; snap-on type

www.wago.com/2009-115/000-012



Item no.: 2009-115/000-017
WMB-Inline; for smartPRINTER; on reel; stretchable 5 - 5.2 mm; plain; snap-on type

www.wago.com/2009-115/000-017



Item no.: 2009-115/000-023
WMB-Inline; for smartPRINTER; on reel; stretchable 5 - 5.2 mm; plain; snap-on type

www.wago.com/2009-115/000-023



















Item no.: 2009-115/000-024
WMB-Inline; for smartPRINTER; on reel; stretchable 5 - 5.2 mm; plain; snap-on type

www.wago.com/2009-115/000-024



Item no.: 2009-145
Mini-WSB Inline; for smartPRINTER; on reel; stretchable 5 - 5.2 mm; plain; snap-on type

www.wago.com/2009-145

	<p>Item no.: 2009-145/000-002 Mini-WSB Inline; for smartPRINTER; on reel; stretchable 5 - 5.2 mm; plain; snap-on type</p>	www.wago.com/2009-145/000-002
	<p>Item no.: 2009-145/000-005 Mini-WSB Inline; for smartPRINTER; on reel; stretchable 5 - 5.2 mm; plain; snap-on type</p>	www.wago.com/2009-145/000-005
	<p>Item no.: 2009-145/000-006 Mini-WSB Inline; for smartPRINTER; on reel; stretchable 5 - 5.2 mm; plain; snap-on type</p>	www.wago.com/2009-145/000-006
	<p>Item no.: 2009-145/000-007 Mini-WSB Inline; for smartPRINTER; on reel; stretchable 5 - 5.2 mm; plain; snap-on type</p>	www.wago.com/2009-145/000-007
	<p>Item no.: 2009-145/000-012 Mini-WSB Inline; for smartPRINTER; on reel; stretchable 5 - 5.2 mm; plain; snap-on type</p>	www.wago.com/2009-145/000-012
	<p>Item no.: 2009-145/000-023 Mini-WSB Inline; for smartPRINTER; on reel; stretchable 5 - 5.2 mm; plain; snap-on type</p>	www.wago.com/2009-145/000-023
	<p>Item no.: 2009-145/000-024 Mini-WSB Inline; on reel; stretchable 5 - 5.2 mm; plain; snap-on type</p>	www.wago.com/2009-145/000-024
	<p>Item no.: 2009-191 Group marker carrier</p>	www.wago.com/2009-191
	<p>Item no.: 2009-192 Group marker carrier</p>	www.wago.com/2009-192
	<p>Item no.: 2009-193 Group marker carrier</p>	www.wago.com/2009-193
	<p>Item no.: 2009-198 Adaptor</p>	www.wago.com/2009-198
	<p>Item no.: 248-501 Miniature WSB Quick marking system; plain; Marker width 5 mm; 10 strips with 10 markers per card</p>	www.wago.com/248-501
	<p>Item no.: 248-501/000-002 Mini-WSB marking card; as card; not stretchable; plain; snap-on type</p>	www.wago.com/248-501/000-002
	<p>Item no.: 248-501/000-005 Mini-WSB marking card; as card; plain; snap-on type</p>	www.wago.com/248-501/000-005
	<p>Item no.: 248-501/000-006 Mini-WSB marking card; as card; not stretchable; plain; snap-on type</p>	www.wago.com/248-501/000-006
	<p>Item no.: 248-501/000-007 Mini-WSB marking card; as card; not stretchable; plain; snap-on type</p>	www.wago.com/248-501/000-007



Item no.: 248-501/000-012
Mini-WSB marking card; as card; not stretchable; plain; snap-on type

www.wago.com/248-501/000-012



Item no.: 248-501/000-017
Mini-WSB marking card; as card; not stretchable; plain; snap-on type

www.wago.com/248-501/000-017



Item no.: 248-501/000-023
Mini-WSB marking card; as card; not stretchable; plain; snap-on type

www.wago.com/248-501/000-023



Item no.: 248-501/000-024
Mini-WSB marking card; as card; not stretchable; plain; snap-on type

www.wago.com/248-501/000-024



Item no.: 793-501
WMB marking card; as card; not stretchable; plain; snap-on type

www.wago.com/793-501



Item no.: 793-501/000-002
WMB marking card; as card; not stretchable; plain; snap-on type

www.wago.com/793-501/000-002



Item no.: 793-501/000-005
WMB marking card; as card; not stretchable; plain; snap-on type

www.wago.com/793-501/000-005



Item no.: 793-501/000-006
WMB marking card; as card; not stretchable; plain; snap-on type

www.wago.com/793-501/000-006



Item no.: 793-501/000-007
WMB marking card; as card; not stretchable; plain; snap-on type

www.wago.com/793-501/000-007



Item no.: 793-501/000-012
WMB marking card; as card; not stretchable; plain; snap-on type

www.wago.com/793-501/000-012



Item no.: 793-501/000-017
WMB marking card; as card; not stretchable; plain; snap-on type

www.wago.com/793-501/000-017



Item no.: 793-501/000-023
WMB marking card; as card; not stretchable; plain; snap-on type

www.wago.com/793-501/000-023



Item no.: 793-501/000-024
WMB marking card; as card; not stretchable; plain; snap-on type

www.wago.com/793-501/000-024



Item no.: 793-5501
WMB marking card; as card; for terminal block width 5 - 17.5 mm; stretchable 5 - 5.2 mm; plain; snap-on type

www.wago.com/793-5501



Item no.: 793-5501/000-002
WMB marking card; as card; for terminal block width 5 - 17.5 mm; stretchable 5 - 5.2 mm; plain; snap-on type

www.wago.com/793-5501/000-002



Item no.: 793-5501/000-005
WMB marking card; as card; stretchable 5 - 5.2 mm; plain; snap-on type

www.wago.com/793-5501/000-005



Item no.: 793-5501/000-006
WMB marking card; as card; stretchable 5 - 5.2 mm; plain; snap-on type

www.wago.com/793-5501/000-006



Item no.: 793-5501/000-007
WMB marking card; as card; stretchable 5 - 5.2 mm; plain; snap-on type

www.wago.com/793-5501/000-007



Item no.: 793-5501/000-012
WMB marking card; as card; stretchable 5 - 5.2 mm; plain; snap-on type

www.wago.com/793-5501/000-012



Item no.: 793-5501/000-017
WMB marking card; as card; stretchable 5 - 5.2 mm; plain; snap-on type

www.wago.com/793-5501/000-017



Item no.: 793-5501/000-023
WMB marking card; as card; stretchable 5 - 5.2 mm; plain; snap-on type

www.wago.com/793-5501/000-023



Item no.: 793-5501/000-024
WMB marking card; as card; stretchable 5 - 5.2 mm; plain; snap-on type

www.wago.com/793-5501/000-024

Protective Warning Marker



Item no.: 2006-115
Protective warning marker; with high-voltage symbol, black; for 5 terminal blocks

www.wago.com/2006-115

tools



Item no.: 210-721
Operating tool with partially insulated shaft; Type 3, blade (5.5 x 0.8) mm

www.wago.com/210-721

check



Item no.: 2009-174
Test plug adapter; for 4 mm Ø test plugs; for testing TOPJOB®S rail-mounted terminal blocks

www.wago.com/2009-174



Item no.: 2009-182
Testing tap; for max. 2.5 mm²; tool-free connection for individual test wires 0.08 - 2.5 mm

www.wago.com/2009-182



Item no.: 210-136
Test plug; 2 mm Ø; with 500 mm cable

www.wago.com/210-136

End plate



Item no.: 2006-8691
End and intermediate plate; 1 mm thick









www.wago.com/2006-8691





Item no.: 2006-8692
End and intermediate plate; 1 mm thick

www.wago.com/2006-8692







Carrier rail

	Item no.: 210-112 Steel carrier rail; 35 x 7.5 mm; 1 mm thick; 2 m long; slotted; according to EN 60715; "Hole width 25 mm	www.wago.com/210-112
	Item no.: 210-113 Steel carrier rail; 35 x 7.5 mm; 1 mm thick; 2 m long; unslotted; according to EN 60715	www.wago.com/210-113
	Item no.: 210-114 Steel carrier rail; 35 x 15 mm; 1.5 mm thick; 2 m long; unslotted; similar to EN 60715	www.wago.com/210-114
	Item no.: 210-115 Steel carrier rail; 35 x 7.5 mm; 1 mm thick; 2 m long; slotted; according to EN 60715; "Hole width 18 mm	www.wago.com/210-115
	Item no.: 210-118 Steel carrier rail; 35 x 15 mm; 2.3 mm thick; 2 m long; unslotted; according to EN 60715	www.wago.com/210-118
	Item no.: 210-196 Aluminum carrier rail; 35 x 8.2 mm; 1.6 mm thick; 2 m long; unslotted; similar to EN 60715	www.wago.com/210-196
	Item no.: 210-197 Steel carrier rail; 35 x 15 mm; 1.5 mm thick; 2 m long; slotted; similar to EN 60715	www.wago.com/210-197
	Item no.: 210-198 Copper carrier rail; 35 x 15 mm; 2.3 mm thick; 2 m long; unslotted; according to EN 60715	www.wago.com/210-198

General accessories

	Item no.: 2002-121 Adaptor	www.wago.com/2002-121
	Item no.: 2006-191 Lockout cap; for wire insertion and actuating opening	www.wago.com/2006-191

ferrule

	Item no.: 216-208 Ferrule; Sleeve for 6 mm ² / AWG 10; insulated; electro-tin plated; electrolytic copper; gastight crimped; acc. to DIN 46228, Part 4/09.90	www.wago.com/216-208
	Item no.: 216-262 Ferrule; Sleeve for 0.75 mm ² / AWG 20; insulated; electro-tin plated; electrolytic copper; gastight crimped; acc. to DIN 46228, Part 4/09.90	www.wago.com/216-262
	Item no.: 216-263 Ferrule; Sleeve for 1 mm ² / AWG 18; insulated; electro-tin plated; electrolytic copper; gastight crimped; acc. to DIN 46228, Part 4/09.90	www.wago.com/216-263
	Item no.: 216-264 Ferrule; Sleeve for 1.5 mm ² / AWG 16; insulated; electro-tin plated; electrolytic copper; gastight crimped; acc. to DIN 46228, Part 4/09.90	www.wago.com/216-264
	Item no.: 216-266 Ferrule; Sleeve for 2.5 mm ² / AWG 14; insulated; electro-tin plated; electrolytic copper; gastight crimped; acc. to DIN 46228, Part 4/09.90	www.wago.com/216-266
	Item no.: 216-267 Ferrule; Sleeve for 4 mm ² / AWG 12; insulated; electro-tin plated; electrolytic copper; gastight crimped; acc. to DIN 46228, Part 4/09.90	www.wago.com/216-267



Downloads

Documentation

Bid Text

2006-8671	Aug 13, 2018	DOCX 15.8 kB	Download
-----------	--------------	-----------------	----------

smartDATA

CAD data

3D Download 2006-8671	URL	Download
-----------------------	-----	----------

Product family

TOPJOB® S

TOPJOB® S: In various industrial applications and modern building installations, WAGO's wide and versatile range of rail-mount terminal blocks provides more than just reliable electrical connections.

[Learn more about the product family.](#)

[Show all products from the family](#)

Subject to changes.

WAGO Kontakttechnik GmbH & Co. KG
Hansastr. 27
32423 Minden
Phone: +49571 887-0 | Fax: +49571 887-169
Email: info.de@wago.com | Web: www.wago.com

Do you have any questions about our products?
We are always happy to take your call at +49 (571) 887-44222.