

Front adapters - VIP-PA-FLK14/ 1,5M/S7 - 2322689

Please be informed that the data shown in this PDF Document is generated from our Online Catalog. Please find the complete data in the user's documentation. Our General Terms of Use for Downloads are valid (<http://download.phoenixcontact.com>)



VIP-VARIOFACE front adapter, with connected system cables for SIMATIC S7 300, 2 x 8 channels can be connected, cable length: 1.5 m

Product Features

- Power supply via terminal blocks with spring-cage double connection
- Can be screwed on with the I/O module
- Encapsulated socket strips on the module side

Key commercial data

package_quantity	1
GTIN	4046356452489

Technical data

General

Note	Analog I/O cards: To avoid short-circuits, all bridges must be removed! No voltage supply may be supplied to the front adapter!
Note	Digital I/O cards: The front adapter is delivered non-isolated. By removing the bridges, electrical isolation (in groups of 8) can be obtained.
Nominal voltage U_N	< 50 V AC
Nominal voltage U_N	60 V DC
Max. permissible current	1 A (per path)
Channels which can be connected	16
Connection type, connector	IDC/FLK socket strip (2.54 mm)
Number of connectors	2
No. of positions, connector	14
Standards/regulations	IEC 60664
Standards/regulations	IEC 62103
Standards/regulations	DIN EN 50178
Rated surge voltage / insulation	0.8 kV
Pollution degree	2
Surge voltage category	III

Supported controller

Control	SIEMENS S7-300 / ET 200 M
- suitable I/O card	6ES7 321-1BH50-0AA0

Front adapters - VIP-PA-FLK14/ 1,5M/S7 - 2322689

Technical data

Supported controller

- suitable I/O card	6ES7 321-7BH01-0AB0
- suitable I/O card	6ES7 321-1BH02-0AA0
- suitable I/O card	6ES7 321-1BH10-0AA0
- suitable I/O card	6ES7 322-1BH01-0AA0
- suitable I/O card	6ES7 322-8BF00-0AB0
- suitable I/O card	6ES7 323-1BH01-0AA0
- suitable I/O card	6ES7 331-7HF01-0AB0
- suitable I/O card	6ES7 331-7KF02-0AB0
- suitable I/O card	6ES7 331-7KB02-0AB0
- suitable I/O card	6ES7 331-7TF01-0AB0
- suitable I/O card	6ES7 332-5HD01-0AB0
- suitable I/O card	6ES7 332-5HB01-0AB0
- suitable I/O card	6ES7 332-7ND02-0AB0
- suitable I/O card	6ES7 332-8TF01-0AB0
- suitable I/O card	6ES7 334-0CE01-0AA0
- suitable I/O card	6ES7 334-0KE00-0AB0
- suitable I/O card	6ES7 335-7HG01-0AB0
- suitable I/O card	6ES7 338-4BC01-0AB0
- suitable I/O card	6ES7 350-1AH03-0AE0
- suitable I/O card	6ES7 351-1AH01-0AE0
- suitable I/O card	6ES7 352-1AH02-0AE0
- suitable I/O card	6ES7 353-1AH01-0AE0
- suitable I/O card	6ES7 354-1AH01-0AE0
- suitable I/O card	6ES7 355-0VH10-0AE0
- suitable I/O card	6ES7 355-1VH10-0AE0

classifications

eCl@ss

eCl@ss 4.0	27060306
eCl@ss 4.1	27060306
eCl@ss 5.0	27061801
eCl@ss 5.1	27061801
eCl@ss 6.0	27061801
eCl@ss 7.0	27061801
eCl@ss 8.0	27061801

ETIM

ETIM 2.0	EC000237
ETIM 3.0	EC000237
ETIM 4.0	EC000237
ETIM 5.0	EC002584

Front adapters - VIP-PA-FLK14/ 1,5M/S7 - 2322689

classifications

UNSPSC

UNSPSC 6.01	26121620
UNSPSC 7.0901	26121620
UNSPSC 11	26121620
UNSPSC 12.01	26121620
UNSPSC 13.2	26121620

approvals

UL Recognized / cUL Recognized / cULus Recognized /

Approval details



Drawings

Front adapters - VIP-PA-FLK14/ 1,5M/S7 - 2322689

Circuit diagram

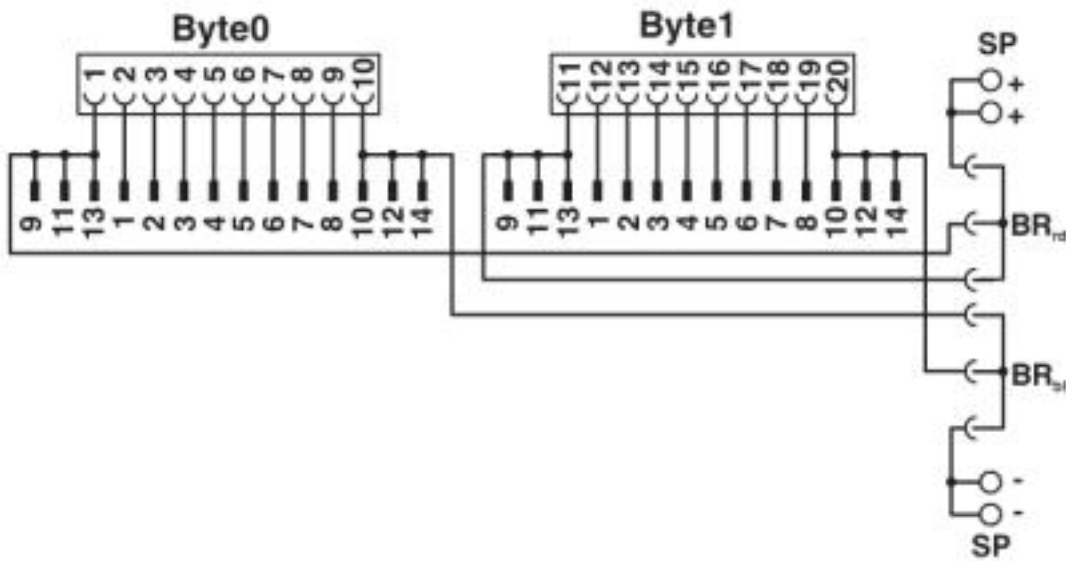

© Phoenix Contact 2013 - all rights reserved
<http://www.phoenixcontact.com>