

Interface module - DFLK-D37 SUB/B - 2280349

Please be informed that the data shown in this PDF Document is generated from our Online Catalog. Please find the complete data in the user's documentation. Our General Terms of Use for Downloads are valid (<http://download.phoenixcontact.com>)



The VARIOFACE feed-through module implements a 1:1 connection between screw connection terminal blocks and a D-SUB miniature socket strip (number of positions: 37). A separate ground tap is available.

Product Features

- 9 to 50-pos.
- 9 to 37-pos.: separate ground tap
- 50-pos.: no ground tap
- According to IEC 60807-2
- 1:1 connection
- Screw connection
- D-SUB 4-40 UNC thread

Key commercial data

package_quantity	5
GTIN	4017918054458

Technical data

Dimensions

Width	39 mm
Height	128.4 mm
Depth	33 mm

Ambient conditions

Ambient temperature (operation)	-20 °C ... 50 °C
Ambient temperature (storage/transport)	-20 °C ... 70 °C

General

Nominal voltage U_N	125 V AC/DC
Max. current carrying capacity per branch	2.5 A
Max. total current of all branches	92.5 A
Number of positions	37
Status display	No
Mounting position	Any
Assembly instructions	In rows with zero spacing
Standards/specifications	Air and creepage distances DIN EN 50178
Pollution degree	2

Interface module - DFLK-D37 SUB/B - 2280349

Technical data

General

Surge voltage category	II
Rated surge voltage	1.2 kV
Rated insulation voltage	125 V

Connection data for connection 1

Connection name	Field level
Connection in acc. with standard	IEC / EN
Connection method	Screw connection
Conductor cross section solid min.	0.2 mm ²
Conductor cross section solid max.	4 mm ²
Conductor cross section stranded min.	0.2 mm ²
Conductor cross section stranded max.	2.5 mm ²
Conductor cross section AWG/kcmil min.	24
Conductor cross section AWG/kcmil max	12
Stripping length	8 mm
Screw thread	M3

Connection data for connection 2

Connection name	Control system level
Connection method	D-SUB socket strip
Number of positions	37

classifications

eCl@ss

eCl@ss 4.0	27250313
eCl@ss 4.1	27250313
eCl@ss 5.0	27250313
eCl@ss 5.1	27250313
eCl@ss 6.0	27242608
eCl@ss 7.0	27141152
eCl@ss 8.0	27141152

ETIM

ETIM 2.0	EC001434
ETIM 3.0	EC001604
ETIM 4.0	EC001604
ETIM 5.0	EC002780

UNSPSC

UNSPSC 6.01	30211824
UNSPSC 7.0901	39121421
UNSPSC 11	39121421
UNSPSC 12.01	39121421

Interface module - DFLK-D37 SUB/B - 2280349

classifications

UNSPSC

UNSPSC 13.2	39121421
--------------------	----------

approvals

UL Recognized / cUL Recognized / GOST / cULus Recognized /

Approval details

UL Recognized	
Nominal voltage UN	125 V
Nominal current IN	2.5 A
mm ² /AWG/kcmil	30-12

cUL Recognized	
Nominal voltage UN	125 V
Nominal current IN	2.5 A
mm ² /AWG/kcmil	30-12

GOST

cULus Recognized

accessories

System cable

CABLE-D37SUB/B/S/ 50/KONFEK/S - 2302191



Interface module - DFLK-D37 SUB/B - 2280349

accessories

CABLE-D37SUB/B/S/100/KONFEK/S - 2302201



CABLE-D37SUB/B/S/150/KONFEK/S - 2302214



CABLE-D37SUB/B/S/200/KONFEK/S - 2302227



CABLE-D37SUB/B/S/300/KONFEK/S - 2302230



CABLE-D37SUB/B/S/400/KONFEK/S - 2302243



CABLE-D37SUB/B/S/600/KONFEK/S - 2302256



Interface module - DFLK-D37 SUB/B - 2280349

accessories

CABLE D-SUB-S/.../.../... - 2302340



CABLE D-SUB-S-S/.../.../... - 2302434



CABLE-D-37SUB/M/OE/0,25/S/0,5M - 2926577



CABLE-D-37SUB/M/OE/0,25/S/1,0M - 2926580



CABLE-D-37SUB/M/OE/0,25/S/1,5M - 2926593



Interface module - DFLK-D37 SUB/B - 2280349

accessories

CABLE-D-37SUB/M/OE/0,25/S/2,0M - 2926603



CABLE-D-37SUB/M/OE/0,25/S/3,0M - 2926616



CABLE-D-37SUB/M/OE/0,25/S/4,0M - 2926629



CABLE-D-37SUB/M/OE/0,25/S/6,0M - 2926632



CABLE-D-37SUB-M-OE-0,25-S/... - 2900912



Drawings

Interface module - DFLK-D37 SUB/B - 2280349

Dimensioned drawing

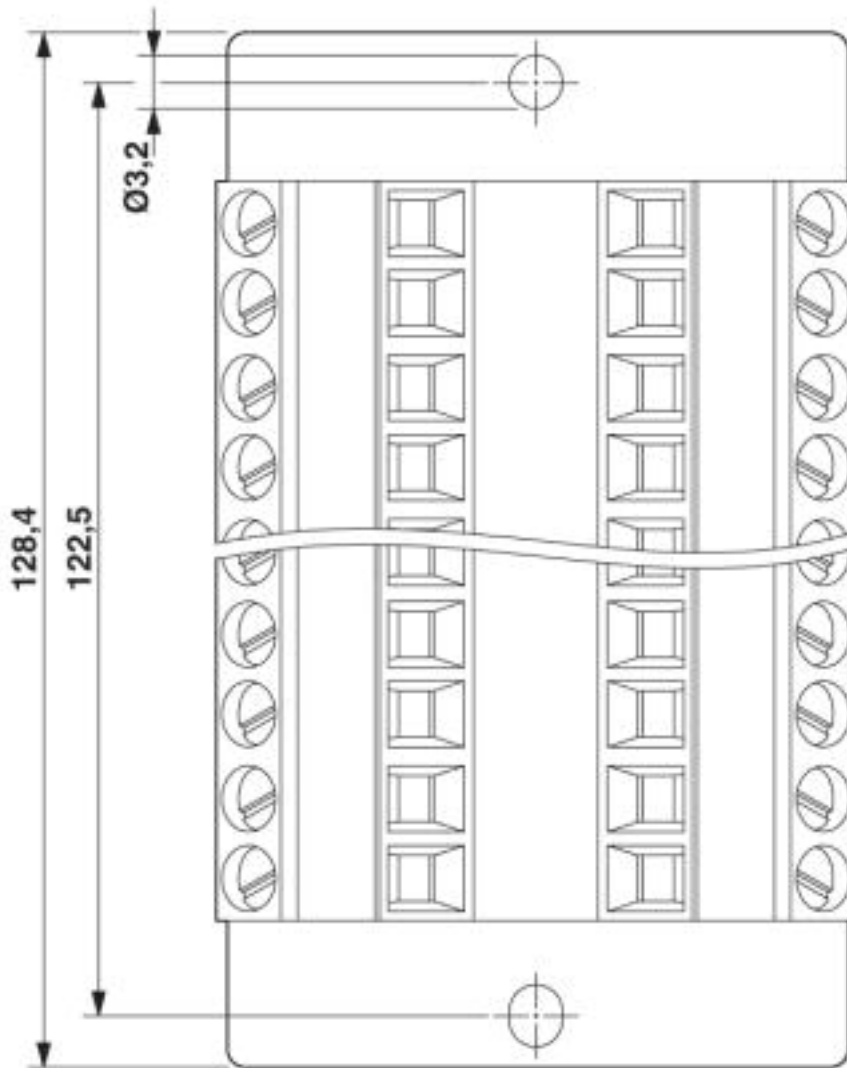

Interface module - DFLK-D37 SUB/B - 2280349

Dimensioned drawing

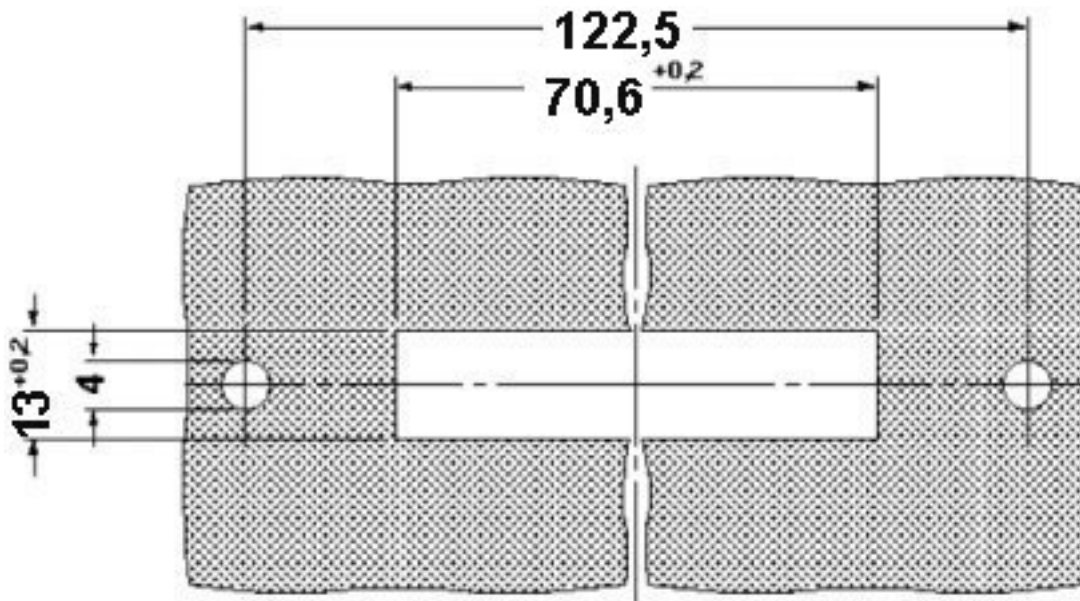

Interface module - DFLK-D37 SUB/B - 2280349

Dimensioned drawing

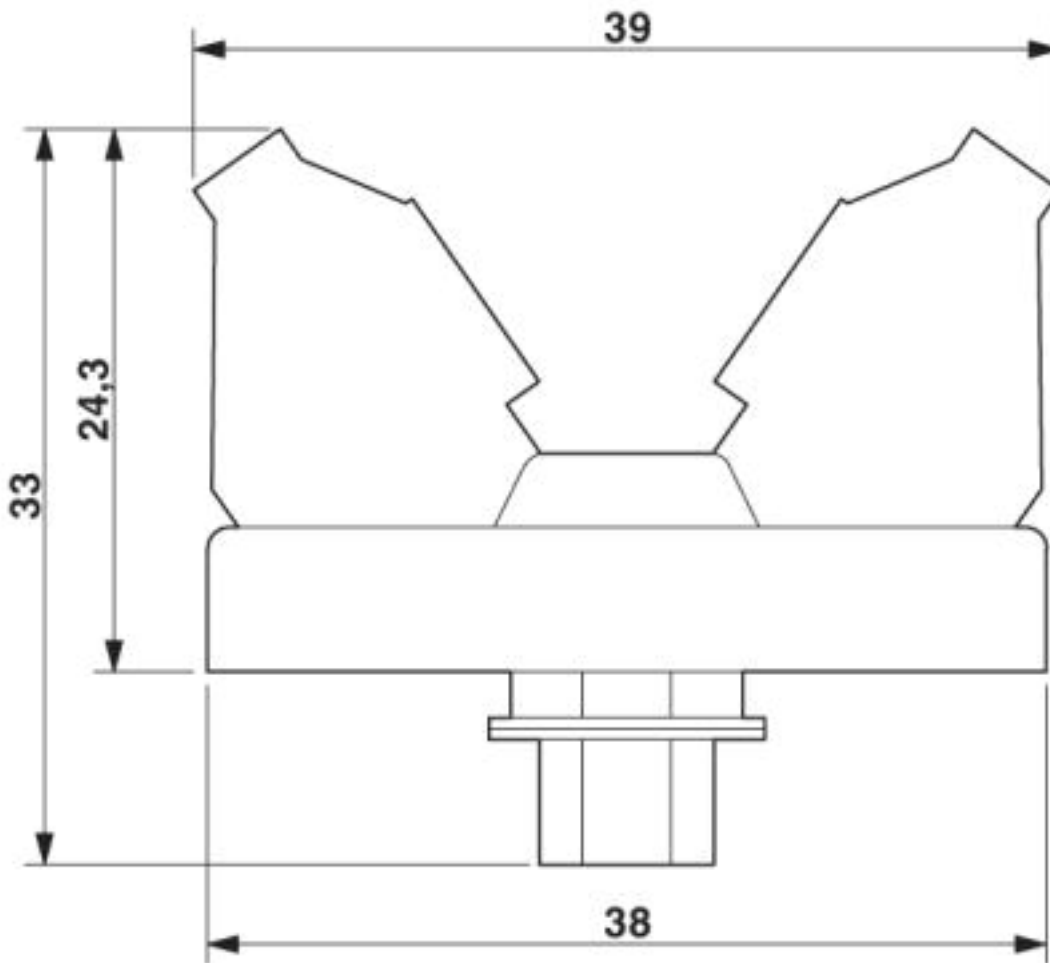

© Phoenix Contact 2013 - all rights reserved
<http://www.phoenixcontact.com>