

# Cockpit System

Optional

1

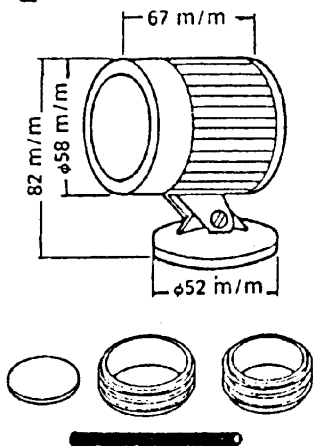

2

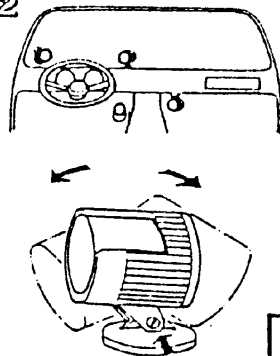

3

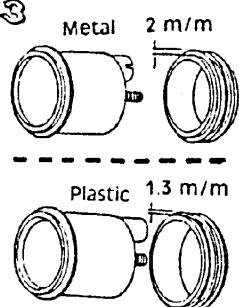

4

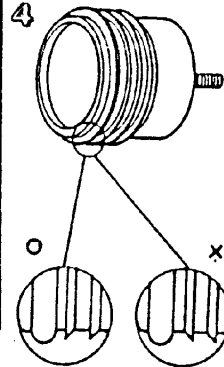

5

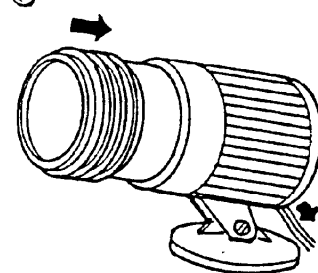

7

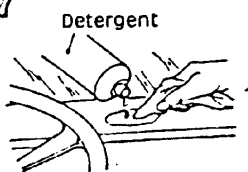

8

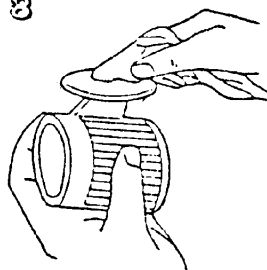

9

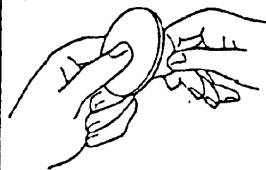

10

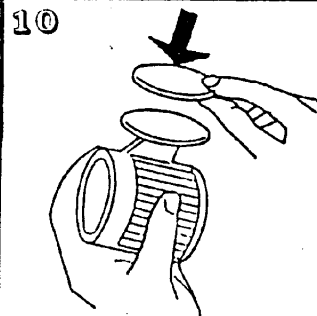

6

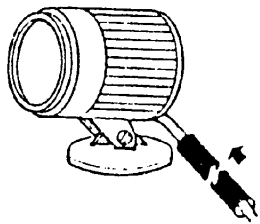

11



12

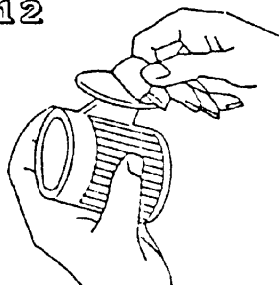

13

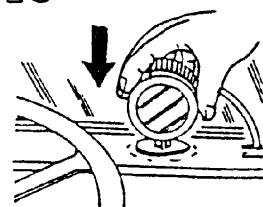

14

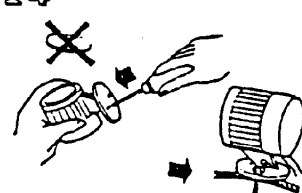

# OIL PRESSURE GAUGE

61523

C730-125-2CB

1

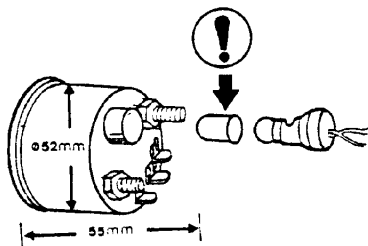

2

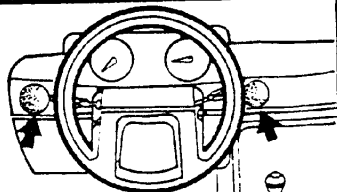

4

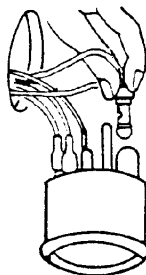

5

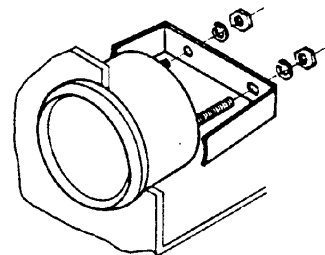

3

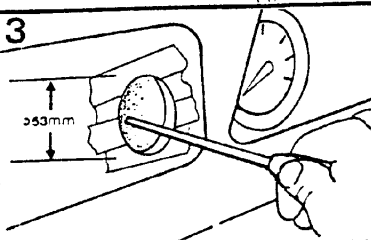

6

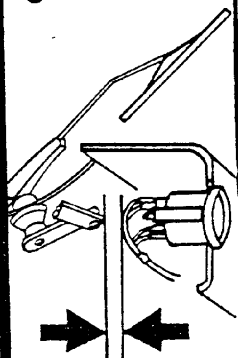

7

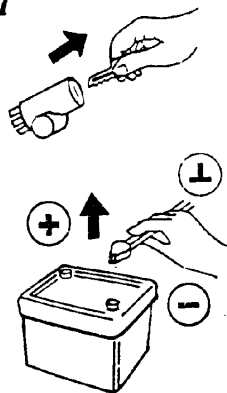

8

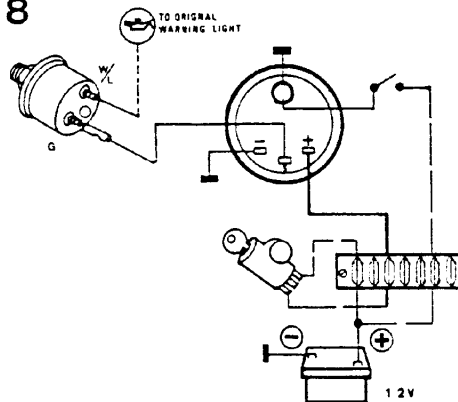

9

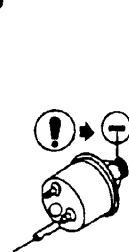

10

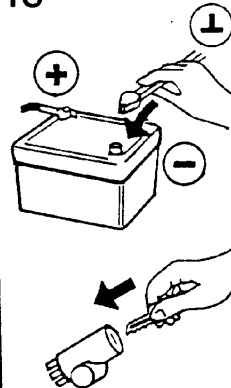

(D)  
ADAPTER-ANWENDUNGSLISTE  
FUER BORDINSTRUMENTE

Die Fuehler fuer Wasserthermometer, Oelthermometer und Oeldruckmesser sind von der Fabrik mit einem Gewinde von 1/8-27 NPTF ausgestattet. Sollte das Gewinde Ihres Motorblockes gleich sein, koennen o.g. Fuehler ohne Ist Ihr Gewinde anders (siehe beiliegende Anwendungsliste) ist ein zusaetzlicher Adapter notwendig.

(GB)  
ADAPTER APPLICATION LIST  
FOR DASHBOARD INSTRUMENTS

The sending unit supplied with this gauge is already threaded 1/8-27 NPTF. If the opening on your engine block has the same thread size (e.g. British Leyland engines) you can directly install the sending unit without the need for an adapter. If the thread size on your engine is different from the sending unit, look up in the following adapter application list for the correct adapter required for your specific engine. The adapter may be obtained from the factory or from your dealer. Always consult your dealer or a professional mechanic should you have installation problems.

Kfz	Modell	Gewinde Wasserthermometer	Gewinde Oelfernthermometer	Gewinde Oeldruckmesser
-----	--------	---------------------------	----------------------------	------------------------

A L F A R O M E O

Alfasud	1,2; Ti 1,2; Ti 1,3; 1,35; Ti 1,5; 1,5; Sprint, Sprint 1,35; Sprint 1,5	M16 X 1,5	M22 X 1,5	M14 X 1,5
Giulia Super	1300 L; 1600 L	M16 X 1,5	M22 X 1,5	
Alfetta	1,6/L/GTI 1,8/L/GT; GTV 2000/L GTV/6/2,5	M16 X 1,5	M22 X 1,5	
Spider/GT Junior	1300; 1600; 2000	M16 X 1,5	M22 X 1,5	
2000	Berlina L, Berlina GT Veloce	M16 X 1,5	M22 X 1,5	
Gioietta	1,3; 1,6; 1,8; 2,0	M16 X 1,5	M22 X 1,5	
Alfa 6		M16 X 1,5	M22 X 1,5	

A U D I

Audi 80	alle Modell		M14 X 1,5	M10 X 1
Audi 100	CS; L; GL; C; CL; CD; S; LS; GLS; CC; CS Diesel; 5D; L5D; GL5D; 5S; L5S; GL5S CS 5-Zyl.; SE; CS; CD 5-Zyl.		M14 X 1,5	M10 X 1
Audi Coupe	GL; GT; GT 5-Zyl.		M14 X 1,5	M10 X 1
Audi 200	SE; ST		M14 X 1,5	M10 X 1
Audi Quattro			M14 X 1,5	M10 X 1

A U T O B I A N C H I

A 112; Junior; A 112 E; Elite; Elegant; Abarth	M16 X 1,5	M22 X 1,5	M12 X 1,5
--	-----------	-----------	-----------

B R I T I S H L E Y L A N D

Mini	850 MK II; 1000 MK II; Spezial 1000; 1001; 5/8-18 UNF			1/8-27 NPTF
Innocenti	1100; Metro 1000; Metro 1300			
Austin	90 L; 120 L	5/8-18 UNF		1/8-27 NPTF
Allegro	1300	5/8-18 UNF		1/8-27 NPTF
Maxi	3; 1100; 1300; 1500	5/8-18 UNF		1/8-27 NPTF
Princess	1500; 1750; 1750 HL	5/8-18 UNF		1/8-27 NPTF
Triumph	1800 HL; 2200 HLS	5/8-18 UNF		1/8-27 NPTF
	Spitfire	5/8-18 UNF		1/8-27 NPTF
	TR 7	5/8-18 UNF		1/8-27 NPTF
MG	B	5/8-18 UNF		1/8-27 NPTF
Jaguar	XJ 4,2/4,2 LC	5/8-18 UNF		1/8-27 NPTF
	XJ 6/4,2			
	XJ 12; E-Type			

B M W

320i; 325i 3er td	M14 X 1,5	M22 X 1,5	M12 X 1,5
Baureihe E 30, Motorbaureihe M 20			
315; 318; 318i; 320,4- und 6-Zyl	M14 X 1,5	M22 X 1,5	
323i 6-Zyl.			
518; 520; 525i; 528i; 5er td	M14 X 1,5	M22 X 1,5	M12 X 1,5
Baureihe E 28 bis 12.87			
525	M14 X 1,5	M22 X 1,5	
530i; 535i	M14 X 1,5	M22 X 1,5	M12 X 1,5
Baureihe E 34 ab 1.88, Motorbaureihe M 30			
628 CSI; 630 CS; 633 CSI; 635 CSI	M14 X 1,5	M22 X 1,5	
730i; 735i	M14 X 1,5	M22 X 1,5	M12 X 1,5
Baureihe E 32 Motorbaureihe M 30			
728; 728i; 730; 732i; 733i	M14 X 1,5	M22 X 1,5	
Alpina 86 2,8	M14 X 1,5	M22 X 1,5	
1502 bis 2002; 2002 Tii	M14 X 1,5	M22 X 1,5	

\*Alle BMW-Typen werden serienmaessig mit 2 verschiedenen Oelablassschrauben geliefert. Entweder M 22 X 1,5 oder M 12 X 1,5.

C I T R O E N

2 CV/Dyana	4; 6	M18 X 1,5	M16 X 1,5	M12 X 1,5
	LN; LNA	M18 X 1,5	M16 X 1,5	M12 X 1,5
Visa	Spec./Club; 2-Zyl.-Club; 4-Zyl. Super	M18 X 1,5	M16 X 1,5	
CS	X; Club; Special; X2; X3	M18 X 1,5	M16 X 1,5	M12 X 1,5
GSA	Club/Pallas X; Break Club	M18 X 1,5	M16 X 1,5	M12 X 1,5

Kfz	Modell	Gewinde Wasserthermometer	Gewinde Oelfernthermometer	Gewinde Oeldruckmesser
CX	reflex; 2000; 2200; 2000 D; 2400; 2400 GTi; 2500 D; Comfort Pallas	M16 X 1,5	M16 X 1,5	M14 X 1,5
BX	14	M18 X 1,5	M16 X 1,5	M12 X 1,5

D A I H A T S U

Cuora	2-Zylinder		M18 X 1,5	R 1/8 DIN 2999
Charade	3-Zylinder		M18 X 1,5	R 1/8 DIN 2999
Charant	1300; 1600		M18 X 1,5	R 1/8 DIN 2999
Wildcat	F20/25; F 50/55		M18 X 1,5	R 1/8 DIN 2999

M E R C E D E S B E N Z

W 123er-Serie	200 D; 220 D; 240 D/TD; 300 D/TD 300 SD/USA; 300 TD-Turbo; 200; 230/G/T; 230 G; 230 E/CE/TE. 250 T; 280/C; 280 E/TE/CE	M14 X 1,5		
W 126er-Serie	280 S; 280 SE/SEL/SL/SLC; 350 SE/SEL; 350 SL/SLC; 450 SE/SEL; 450 SEL 5,3; 450 SL/SLC 450 SLC 5,0 600	M14 X 1,5	M26 X 1,5	

\*Alle Mercedes-Typen werden serienmaessig mit 2 verschiedenen Oelablassschrauben geliefert. Entweder M 14 X 1,5 oder M 12 X 1,5.

F I A T

Panda	Panda; Special		M22 X 1,5	M14 X 1,5
124	Cabrio		M22 X 1,5	M14 X 1,5
126		M16 X 1,5	M22 X 1,5	M14 X 1,5
127	L; Special; CL; Sport	M16 X 1,5	M22 X 1,5	M14 X 1,5
Ritmo	60 L; 60 CL; 65; 75 CL; Super 75 Gala; 85; 105 TC; Abarth 125 TC Diesel	M16 X 1,5	M22 X 1,5	M14 X 1,5
128	CL; Berlinetta LS/GLX	M16 X 1,5	M22 X 1,5	M14 X 1,5
X 1/9		M16 X 1,5	M22 X 1,5	
131	Diesel; Mirafiori S/1,6; Super 1400 TC; CL Panorama; Supermirafiori; Sport; Rallye	M16 X 1,5	M22 X 1,5	M14 X 1,5
132	Diesel; 2000	M16 X 1,5	M22 X 1,5	M14 X 1,5
Super	Panorama Super		M22 X 1,5	M14 X 1,5
Argenta			M22 X 1,5	M14 X 1,5

F O R D

Fiesta	L; Ghia; S; XR 2	1/8-27 NPTF	M14 X 1,5	1/4-18NPTF
Taurus	L; GL; Ghia; S; Ghia S/V6; Ghia V6	1/8-27 NPTF	M14 X 1,5	1/4-18NPTF
Escort	L; GL; Ghia; Ghia S	1/8-27 NPTF	M14 X 1,5	1/4-18NPTF
	XR 3; XR 3i; RSi; RS 2000	1/8-27 NPTF	M14 X 1,5	1/4-18NPTF
Capri II	GL; S; Ghia; V6	1/8-27 NPTF	M14 X 1,5	1/4-18NPTF
bis 9,81				
ab 9,81	L; S; V6; Ghia; 2,8i; 2,8 Turbo	1/8-27 NPTF	M14 X 1,5	1/4-18NPTF
Granada	L; V4; GL; V6; 4R; Ghia	1/8-27 NPTF	M14 X 1,5	1/4-18NPTF
bis 9,81	L; S; GL; Ghia; V6	1/8-27 NPTF	M14 X 1,5	1/4-18NPTF
ab 9,81	Ghia 2,8i; V6; LS; GL; Ghia; Diesel	1/8-27 NPTF	M14 X 1,5	1/4-18NPTF
Sierra	L; GL; Ghia	1/8-27 NPTF	M14 X 1,5	1/4-18NPTF
Transit		1/8-27 NPTF	M14 X 1,5	1/4-18NPTF
	Diesel	1/8-27 NPTF	M16 X 1,5	1/4-18NPTF

H O N D A

Civic	1200; 1300 S/SL; 1300 SS, Lim. bis Bj. 83, Shuttle, CRX-Coupe 6.84	M16 X 1,5		R 1/8 DIN 2999
Accord	Lim. 1.84-12.85 und ab 1.86	M16 X 1,5		R 1/8 DIN 2999
bis Bj. 83			M20 X 1,5	
ab Bj. 84			M14 X 1,5	
Prelude		M16 X 1,5		R 1/8 DIN 2999
1.83-9.87				R 1/8 DIN 2999
und 10.87-				
bis Bj. 83			M20 X 1,5	
ab Bj. 84			M14 X 1,5	

L A D A

Nova	Junior; 1200 L/K; 1300; 1500		M22 X 1,5	M14 X 1,5
Niva	Niva; California		M22 X 1,5	M14 X 1,5

L A N C I A

Delta			M22 X 1,5	
Gamma	2500		M22 X 1,5	

M A Z D A

	323; 1000; 1300; S/SP/V; Stufenheck	M18 X 1,5	M14 X 1,5	
	616; 626; 626, 2.0; 929/L/Coupe	M16 X 1,5	M14 X 1,5	R 1/8 DIN 2999
	RX; 2,3 W; 5 W	M16 X 1,5	M14 X 1,5	
	RX 7 Wankel; 5 W	M16 X 1,5	M14 X 1,5	

M I T S U B I S H I

Colt	1200 GL/GLX; 1400 GLX/GL; 1400 Turbo		M14 X 1,5	R 1/8 DIN 2999
Lancer	1200 GL; 1400 GLX/GL; EX 1400; 1600 GSR; EX 1600		M14 X 1,5	R 1/8 DIN 2999
	2000 Turbo		M18 X 1,5	

Kfz	Modell	Gewinde Wasserther- mometer	Gewinde Oelfern- thermometer	Gewinde Oeldruck- messer
Galant	1600 GL/SL/GLS; 2000 GLX/GLS		M14 X 1,5	R 1/8 DIN 2999
Sapporo	1600 SL; 1600 GL; 2000 GLS; 2000 GSR; 2000 GSL; 2000 Turbo		M14 X 1,5	R 1/8 DIN 2999
Tredia	1400 GLS; 1600 GL; 1600 Turbo		M14 X 1,5	R 1/8 DIN 2999
Starion	Turbo ECI		M14 X 1,5	R 1/8 DIN 2999
L 300			M14 X 1,5	R 1/8 DIN 2999

### N I S S A N (DATSUN)

Sunny	Sunny; Traveller	5/8 X 18 UNF		R 1/8 DIN 2999
Cherry	Alle Modelle	5/8 X 18 UNF		R 1/8 DIN 2999
Urvan	2,0; 2,2 Diesel	5/8 X 18 UNF		R 1/8 DIN 2999
160	J	5/8 X 18 UNF		R 1/8 DIN 2999
180	B	5/8 X 18 UNF		R 1/8 DIN 2999
Stanza	Violet 1,6	5/8 X 18 UNF		R 1/8 DIN 2999
Bluebird	Bluebird; Bluebird Diesel	5/8 X 18 UNF		R 1/8 DIN 2999
Laurel	2,0; 2,4	5/8 X 18 UNF		R 1/8 DIN 2999
Skyline	2,4	5/8 X 18 UNF		R 1/8 DIN 2999
200; 240; 260	L; KGT; 2 2 + 2; 1600 Ti	5/8 X 18 UNF		R 1/8 DIN 2999
280	2X	5/8 X 18 UNF		R 1/8 DIN 2999
Patrol	Patrol; Diesel	5/8 X 18 UNF		R 1/8 DIN 2999
Terano ab 1.88			M12 X 1,25	R 1/8 DIN 2999

### O P E L

Kadett	1,0 M; 1,2 M; 1,2 S; 1,3 L/Berlina 1,3 S/SL/SR; 1,8S/Diesel; 1,9 E/GTE		M14 X 1,5	M14 X 1,5
Ascona	1,2 M; 1,3 M/L/SR; 1,3 Berlina; 1,3 S; 1,6 M; 1,6 SL/SR/Berlina; 1,8 E; 1,9 M; 1,9 S; 2,0 M; 2,0 S; 2,0 E; 2,0 D/DL; 2,0 D Berlina; Diesel 1,5		M14 X 1,5	M14 X 1,5
Manta	1,2 M; 1,2 S; 1,3 L/CC/CL; 1,3 Berlina; 1,6 M; 1,3 Berlina; 1,6 M; 1,8 S/GT/J; 1,9 M; 1,9 S; 2,0; 2,0 S; 2,0 E	1/8-27 NPTF	M14 X 1,5	M14 X 1,5
Rekord	1,7 M; 1,9 M; 1,9 S; 2,0 M; 2,0 S; 2,0 E/LS/Berlina; 2,1 D; 2,3 D/DL; 2,3 D-Berlina		M16 X 1,5	M14 X 1,5
Commodore	2,5 S/GS; 2,8 S/GS; 2,8 GSE		M16 X 1,5	M14 X 1,5
Senator	2,5 E/C; 2,8 C/S/CS; 3,0 C/S/CS; 3,0 E/C/S/CS		M14 X 1,5	M14 X 1,5
Monza	2,5 E/C; 2,8 C; 3,0 C; 3,0 E, C, CD		M14 X 1,5	M14 X 1,5

### P E U G E O T

104	L; GL; ZL; GR; GLS; SL; GL 6; ZR; SR; ZS; S	M18 X 1,5	M18 X 1,5	
304	GLD; Break; GL; SL; S; SLS	M18 X 1,5	M16 X 1,5	
305	GLD; SRD; GL; GLS; SR; S	M18 X 1,5	M18 X 1,5	
504	GRD; SRD; GL; Break D; Break GRD; Fam. D; Break; Cabriolet Ti; GR; SR; Coupe Ti; Coupe V6 Ti	M18 X 1,5	M18 X 1,5	
505	GRD, SRD-Turbo, SL V6, V65 ti, Sti	M18 X 1,5	M16 X 1,5	

### P O R S C H E

924	Turbo; Carrera GT	M14 X 1,5	M14 X 1,5	
928	928; 928 S		M14 X 1,5	
944			M14 X 1,5	

### R E N A U L T

R4	L; TL; GTL	M18 X 1,5	M16 X 1,5	M14 X 1,5
R5	5/850; GTL; TL; TL-Automatik; Automatik; TS;	M18 X 1,5	M16 X 1,5	M14 X 1,5
R5	Alpine		M18 X 1,5	
R5	Alpine Turbo		M18 X 1,5	
R6	6/850	M18 X 1,5	M16 X 1,5	M14 X 1,5
R9	C; GTC; TL; GTL; TS; GTS; TSE		M18 X 1,5	M14 X 1,5
R12	L; TL; TS	M18 X 1,5	M16 X 1,5	M14 X 1,5
R14	TL; LS; TS		M16 X 1,5	M14 X 1,5
R15	TL; GTL		M16 X 1,5	M14 X 1,5
R16	L; TL/Automatik; TS; TX	M18 X 1,5	M16 X 1,5	M14 X 1,5
R18	TL; GTL; Diesel; TS; GES; Turbo; Tx; GTX		M16 X 1,5	M14 X 1,5
R20	TD; GTD; Diesel; TL; GTL; Ti; LS	M18 X 1,5	M16 X 1,5	M14 X 1,5
	TS; TX		M16 X 1,5	
R Alpine	A 310; V6; TS; GTS; TX; GTX		M16 X 1,5	M14 X 1,5
R Fuego		M18 X 1,5	M18 X 1,5	

\*Alle Renault-Typen werden serienmaessig mit zwei verschiedenen Oelablassschrauben geliefert.

### S A A B

99	GL/GLS ab 81	1/8-27 NPTF	M14 X 1,5	
900	GLS; GLi; GLE; EMS; Turbo (alle ab 81)	1/8-27 NPTF	M14 X 1,5	
			1/4-18NPTF	

Kfz	Modell	Gewinde Wasser- thermometer	Gewinde Oelfern- thermometer	Gewinde Oeldruck- messer
<b>S U B A R U</b>				
1800/4 WD	SRX; Sedan; Station; Super Station	M16 X 1,5		R 1/8 DIN 2999

### S U Z U K I

Alto; U 80; Carry; SJ 410				R 1/8 DIN 2999
------------------------------	--	--	--	----------------

### T A L B O T - S I M C A

1100	LE; LX; GLS; ES; Ti	M16 X 1,5	M20 X 1,5	M12 X 1,5
1307	S; GLS	M16 X 1,5	M20 X 1,5	M12 X 1,5
1308	S; GT	M16 X 1,5	M20 X 1,5	M12 X 1,5
1309	SX	M16 X 1,5	M20 X 1,5	M12 X 1,5
1510	LS; GL; GLS; SX	M16 X 1,5	M20 X 1,5	M12 X 1,5
Horizon	LS; GL; GLS; S; SX	M16 X 1,5	M20 X 1,5	M12 X 1,5
Solara	LS; GL; SX	M16 X 1,5	M20 X 1,5	M12 X 1,5
Bagheera	S; X	M16 X 1,5	M20 X 1,5	M12 X 1,5
Matra Murena	1,6; 2,2	M16 X 1,5	M20 X 1,5	M12 X 1,5
Tagora	GL; GLS; SX; TD Turbo Diesel	M16 X 1,5	M20 X 1,5	M12 X 1,5
Samba	LS; GL	M16 X 1,5	M20 X 1,5	

### T O Y O T A

1000 Starlet		M16 X 1,5	M18 X 1,5	R 1/8 DIN 2999
Corolla Liftback	1600; 1600 GLS	M16 X 1,5	M18 X 1,5	R 1/8 DIN 2999
Celica	LT; ST; GT	M16 X 1,5	M18 X 1,5	R 1/8 DIN 2999
Celica Liftback	ST; XT; GT	M16 X 1,5	M18 X 1,5	R 1/8 DIN 2999
Carina	Carina/Kombi	M16 X 1,5	M18 X 1,5	R 1/8 DIN 2999
Cressida		M16 X 1,5	M18 X 1,5	R 1/8 DIN 2999
Land Cruiser	Land Cruiser/De Luxe/GL	M16 X 1,5	M18 X 1,5	
Tercel		M16 X 1,5	M18 X 1,5	R 1/8 DIN 2999
Crown		M16 X 1,5	M18 X 1,5	
Hiace	Hiace/Diesel	M16 X 1,5	M18 X 1,5	R 1/8 DIN 2999
Life-Ace		M16 X 1,5	M18 X 1,5	R 1/8 DIN 2999

### V O L K S W A G E N

Polo	L; C; GL; GLS; C; CL; L; Coupe; Coupe GT		M14 X 1,5	M10 X 1
Derby	L; C; CL; GL; S; LS; GLS		M14 X 1,5	M10 X 1
Golf	L; GL; C; CL; GL; CD; CLD; GLD; S; LS; GLS; TD Turbo Diesel; C, CL Turbo Diesel; GL Turbo Diesel; GTi; D; LD; GLD		M14 X 1,5	M10 X 1
Jetta	L; GL; C; CL; C Turbo Diesel; GL Turbo Diesel; S; LS; GLS; GLi; CD; CLD; GLD		M14 X 1,5	M10 X 1
Scirocco	L; GL; CL; S; LS; GT; GLS; GTi; GLi	1/8-27 NPTF	M14 X 1,5	M10 X 1
Passat	C; CL; GL; L; S; LS; GLS; TS; GLi; CL 5; GL 5; D; LD; GLD Diesel; GL Turbo Diesel		M14 X 1,5	M10 X 1
Santana	CL; GL; GL 5; GL 5, CL; GL Diesel		M14 X 1,5	M10 X 1
Kaefer	Alle Typen		M14 X 1,5	M10 X 1
Bus/Transporter	LT Diesel; LT Diesel 6-Zyl.; LT Benzin		M14 X 1,5	M10 X 1
			M24 X 1,5	

### V O L V O

66	DL; GL	M18 X 1,5	M18 X 1,5	M14 X 1,5
242	L; DL (B19, B19A, B21A)			1/8-27 NPTF
244	L (B19A); DLi (B21E); GLi; GLT; GL; Turbo			1/8-27 NPTF
	GLD-6	M18 X 1,5	M14 X 1,5	M10 X 1
245	GLD-6	M18 X 1,5	M14 X 1,5	M10 X 1
	DLi (B21E)			3/4-16 UNF
262	C	M16 X 1,5	M16 X 1,5	1/8-27 NPTF
264	DL; GLE; DL; TU V6	M18 X 1,5	M16 X 1,5	
265	GL; GLE	M18 X 1,5	M16 X 1,5	
343	L; DL; GL	M18 X 1,5	M18 X 1,5	M14 X 1,5
	DLS; GLS			1/8-27 NPTF
345	GL		M18 X 1,5	M14 X 1,5
	DLS; GLS			1/8-27 NPTF
360	GLS; GLT			1/8-27 NPTF
760			M16 X 1,5	