

DYMO[®]



User Guide

LabelManager[®] 500TS

Copyright

© 2011 Sanford, L.P. All rights reserved.

No part of this document or the software may be reproduced or transmitted in any form or by any means or translated into another language without the prior written consent of Sanford, L.P.

Trademarks

DYMO, DYMO Label, and LabelManager are registered marks in the US and other countries. All other trademarks are the property of their respective holders.

“Sans” is a DejaVu font. The DejaVu fonts are based on Vera fonts copyright © by Bitstream, Inc. Glyphs in the DejaVu fonts imported from Arev fonts are copyright © by Tavmjong Bah. All Rights Reserved.

Contents

| | |
|---|-----------|
| About Your New Label Maker | 6 |
| Registering Your Label Maker | 6 |
| Getting Started | 6 |
| Connecting the Power | 6 |
| Inserting the Battery Pack | 6 |
| Removing the Battery Pack | 6 |
| Charging the Battery Pack | 6 |
| Inserting the Label Cassette | 6 |
| Using the Label Maker for the First Time | 7 |
| Getting to Know the Label Maker | 7 |
| Power | 7 |
| Home | 7 |
| Touch Screen Display | 7 |
| Navigation Keys | 7 |
| Caps Lock | 7 |
| Shift | 7 |
| Backspace | 8 |
| Delete | 8 |
| Using the Touch Screen | 8 |
| Making a Selection | 8 |
| Selecting Text | 8 |
| Scrolling a List | 8 |
| Editing Your Label | 8 |
| Selecting the Font | 8 |
| Changing the Font Type | 9 |
| Changing the Font Size | 9 |
| Changing the Font Style | 9 |
| Inserting Special Characters, Auto-Text, and Barcodes | 9 |
| Inserting Symbols | 9 |
| Inserting Clip Art | 9 |
| Using Auto-Numbering | 9 |
| Inserting the Date and Time | 9 |
| Inserting Barcodes | 10 |
| Inserting Days, Months, or Quarters | 10 |
| Inserting International Characters | 11 |
| Using Word Suggestions | 11 |
| Editing the Label Layout | 11 |
| Adding Borders | 11 |
| Aligning the Text | 11 |
| Using Mirror Text | 11 |
| Using Vertical Text | 12 |
| Creating Fixed-Length Labels | 12 |
| Using the Label Maker Memory | 12 |
| Saving a Label | 12 |
| Downloading Labels | 12 |
| Using Saved Labels | 12 |
| Managing Labels on Your Label Maker | 12 |
| Viewing Saved Labels | 12 |
| Creating New Folders | 12 |
| Deleting Labels and Folders | 12 |
| Clearing Recently Printed Labels | 13 |
| Managing Custom Clip Art | 13 |
| Printing Options | 13 |
| Printing a Series of Labels | 13 |
| Printing Multiple Copies | 13 |
| Turning off Auto-Cut | 14 |
| Printing Cut Marks Between Labels | 14 |
| Customizing Your Label Maker | 14 |
| Changing the Language | 14 |
| Changing the Units of Measure | 14 |

| | |
|---|-----------|
| Changing the Label Width | 14 |
| Changing the Default Font | 14 |
| Changing the Screen Settings | 14 |
| Working with User Accounts | 14 |
| Creating User Accounts | 14 |
| Changing User Settings | 15 |
| Deleting User Accounts | 15 |
| Maintaining Your Label Maker | 15 |
| Cleaning Your Label Maker | 15 |
| Calibrating the Touch Screen | 15 |
| Using the Label Maker with Your Computer | 16 |
| Installing DYMO Label Software | 16 |
| Connecting the Label Maker to Your Computer | 16 |
| Using DYMO Label Software | 17 |
| Viewing the Label Maker Status | 17 |
| Troubleshooting | 18 |
| Documentation Feedback | 18 |
| Safety Precautions for Lithium Polymer Rechargeable Battery Pack | 19 |
| Environmental Information | 19 |

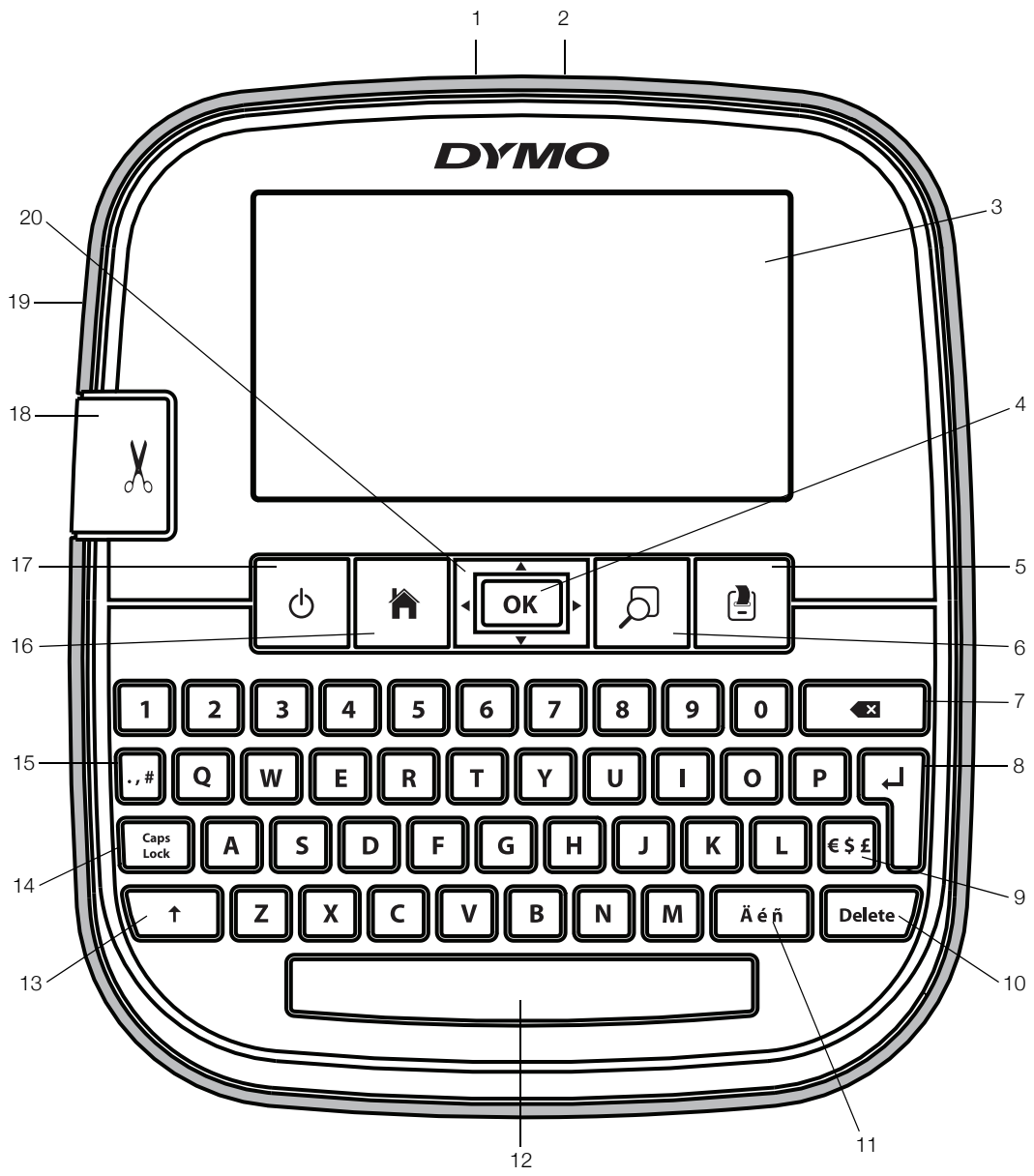

Figure 1 LabelManager 500TS label maker

- | | | | | | |
|----------|-----------------|-----------|---------------------|-----------|-----------------------|
| 1 | USB connector | 8 | Return | 15 | Symbols - Punctuation |
| 2 | Power connector | 9 | Symbols - Currency | 16 | Home |
| 3 | Touch screen | 10 | Delete | 17 | On/Off |
| 4 | OK | 11 | Accented characters | 18 | Cutter |
| 5 | Print | 12 | Space bar | 19 | Label exit slot |
| 6 | Print preview | 13 | Shift | 20 | Navigation |
| 7 | Backspace | 14 | Caps Lock | | |

About Your New Label Maker

With the DYMO LabelManager 500TS label maker, you can create a wide variety of high-quality, self-adhesive labels. You can choose to print your labels in many different font sizes and styles. The label maker uses DYMO D1 label cassettes in widths of 6 mm (1/4"), 9 mm (3/8"), 12 mm (1/2"), 19 mm (3/4"), or 24 mm (1"). Labels are available in a wide range of colors.

Visit www.dymo.com for information on obtaining labels and accessories for your label maker.

Registering Your Label Maker

Visit www.dymo.com/register to register your label maker online.

During the registration process, you will need the serial number, which is located inside the back cover of the label maker.

Getting Started

Follow the instructions in this section to set up your label maker.

Connecting the Power

The label maker is powered by a rechargeable, Lithium Polymer (LiPo) battery pack.

Inserting the Battery Pack

The battery pack included with your label maker comes partially charged.

 Make sure the charging adapter is disconnected before handling the LiPo battery pack.

To insert the battery pack

- 1 Lift the back cover of the label maker.
- 2 Insert the battery pack into the battery compartment as shown.
- 3 Close the back cover of the label maker.

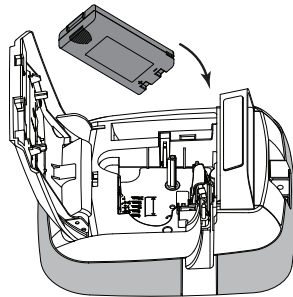

 Make sure to read the LiPo Safety Precautions on page 19.

Removing the Battery Pack

Remove the battery pack when the label maker will not be used for a long period of time.

 Make sure the charging adapter is disconnected before handling the LiPo battery pack.

To remove the battery pack

- 1 Unplug the charging adapter.
- 2 Lift the back cover of the label maker.
- 3 Remove the battery pack from the battery compartment.

 Make sure to read the LiPo Safety Precautions on page 19.

Charging the Battery Pack

Use the charging adapter included with your label maker to recharge the battery pack. Charging the battery pack will take approximately three hours.

 The charging adapter is only used for recharging the battery pack.

To recharge the battery pack

- 1 Turn the label maker over.
- 2 Plug the charging adapter into the power connector at the top of the label maker.
- 3 Plug the other end of the charging adapter into a power outlet.

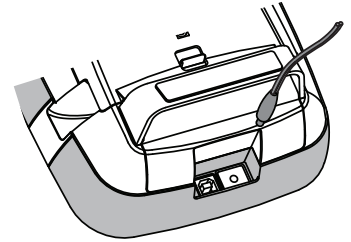

 Make sure to read the LiPo Safety Precautions found on page 19.

Inserting the Label Cassette

Your label maker uses DYMO D1 label cassettes.

To insert the label cassette

- 1 Lift the back cover of the label maker to open the label compartment.
- 2 Make sure the tape and ribbon are taut across the mouth of the cassette and that the tape passes between the label guides.

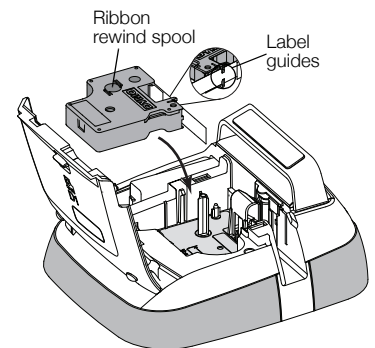

If necessary, turn the ribbon rewind spool clockwise to tighten the ribbon.

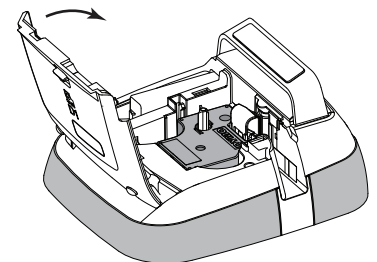

- 3 Insert the cassette and press firmly until the cassette clicks into place.
- 4 Close the back cover of the label maker.



Using the Label Maker for the First Time

The first time you turn on the power, you are asked to select the language, units of measure, and label width. These selections remain set until you change them.

To set up the label maker

- 1 Press  to turn on the label maker.
 The first time you turn on the label maker, the system may take a few moments to start up.
- 2 Select the language and tap **Next**.
- 3 Select the units of measure and the label width, and then tap **Done**.

You are now ready to print your first label.

To print a label

- 1 Using the keyboard, enter text to create a simple label.
- 2 Press .
The label prints and is automatically cut. To turn off the auto-cut feature, see **Turning off Auto-Cut** on page 14.
- 3 Remove the backing from the label to expose the adhesive, and then attach the label.

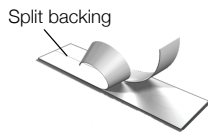



Congratulations! You printed your first label. Continue reading to learn more about the features available for creating labels.

Getting to Know the Label Maker

Become familiar with the location of the function keys on your label maker. Refer to Figure 1 on page 5. The following sections describe each feature in detail.

Power

The  key turns the label maker power on and off. To save power, the label maker goes into standby mode after two minutes of inactivity. Pressing the  key once exits standby mode.

To turn the power completely off, press and hold the  key for five seconds.

When the charging adapter is connected, a clock appears in the display while the label maker is in standby mode.

When the charging adapter is not connected, the clock does not appear and the label maker remains in standby for two additional minutes before the power is turned off.

When the label maker power is turned off automatically, the current label text and formatting are remembered and will be displayed when power to the label maker is turned back on.

When the label maker power is turned off manually or when the battery pack is removed and the power adapter is disconnected, the current label text and formatting are lost.





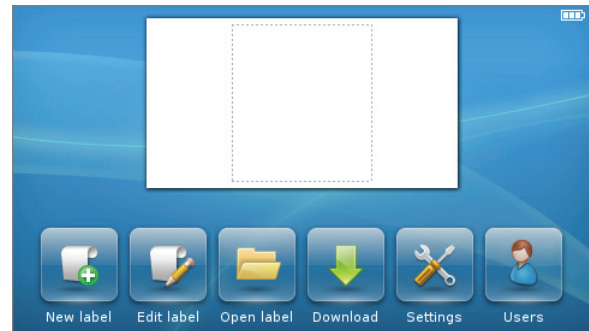

Home

The  key displays the Home screen or cancels any dialog box or pop-up message.

Touch Screen Display

You can create and format labels using the touch screen display.



-  Create a new label.
-  Edit the current label.
-  Open a saved or recently printed label.
-  View downloaded labels.
-  Change the label maker settings.
-  Select a user, create new users, and manage user settings.
-  Displays the status of the battery pack.

Navigation Keys

You can review and edit your label using the left and right navigation keys. You can move through menu selections using all four navigation keys, and then press **OK** to make a selection.

Caps Lock

The  key toggles capitalization on or off. When Caps Lock is on, the Caps Lock key is illuminated and all the letters entered are in uppercase. When Caps Lock is off, all the letters entered are in lowercase. The default setting is Caps Lock off.

Shift

The  key toggles Caps mode on or off for a single alpha character.

Backspace

The **X** key deletes the selected objects or characters. If no objects or characters are selected, the character to the left of the cursor is deleted.

Delete

Similar to the backspace key, the **Delete** key deletes the selected objects or characters. However, if no objects or characters are selected, the character to the right of the cursor is deleted.

Using the Touch Screen

You can make selections and control the touch screen by using your fingers to tap, double-tap, and swipe.

! Do not press on the touch screen with any hard object, such as a fingernail.

Making a Selection

You can make selections on the touch screen by tapping an item.

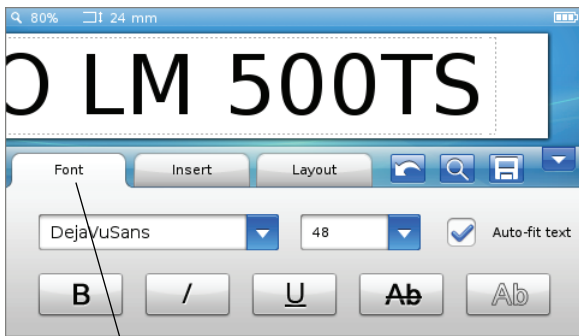

Tap to select a tab, menu item, or check box.

Selecting Text

You can quickly select text to edit or delete.



Double-tap to select a word.

Drag the handles to select more or less text.

Tap to select all text on the label.

Scrolling a List

Dragging a scroll bar moves you quickly through a menu or list.

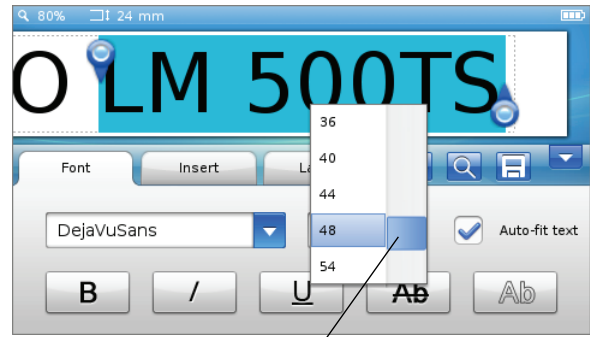

Drag to scroll through a list.

Editing Your Label

You can choose from several format options to enhance the appearance of your labels.

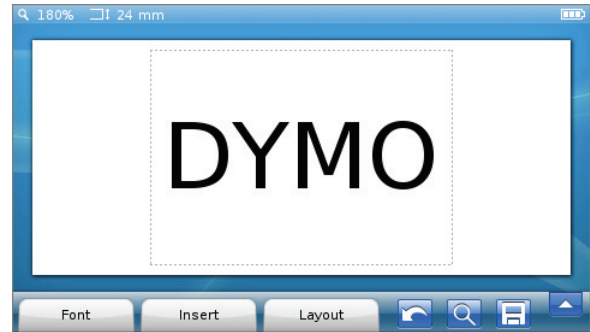

Selecting the Font

You can choose from several format options to enhance the appearance of your labels. You can change the formatting for all or part of the text on your label.

You can change the font type, size, and style.

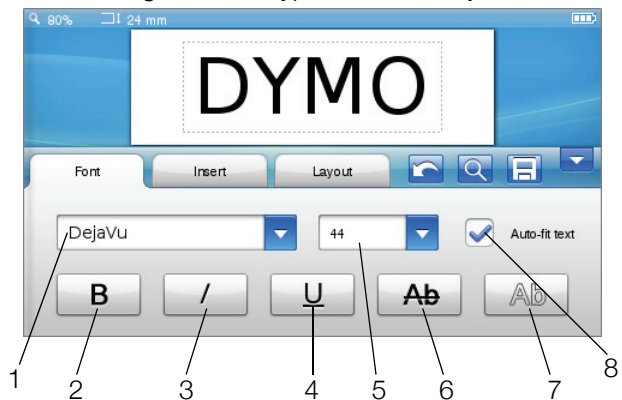

- | | |
|-------------|-----------------|
| 1 Font type | 5 Font size |
| 2 Bold | 6 Strikethrough |
| 3 Italic | 7 Outline |
| 4 Underline | 8 Auto-fit text |

To format your label text

- 1 If necessary, tap  on the Home screen.
- 2 Select the **Font** tab.

Changing the Font Type

You can change the font type for some or all of the text on your label.

To change the font type

- 1 If necessary, select the existing text to change.
 To change the font type for new text only, you do not need to select any existing text.
- 2 Select the desired font type from the font type list.

Changing the Font Size

The font sizes available depend on the label width selected.

To change the font size

- 1 If necessary, select the existing text to change.
 To change the style for new text only, you do not need to select any existing text.
- 2 Select the desired font size from the font size list.

Changing the Font Style

Five font styles are available for your labels: bold, italic, underline, strikethrough, and outline. All styles can be combined.

To change the font style

- 1 If necessary, select the existing text to change.
 To change the style for new text only, you do not need to select any existing text.
- 2 Tap the button for each desired style.

Inserting Special Characters, Auto-Text, and Barcodes

From the Insert tab, you can quickly add symbols, clip art, barcodes, several types of auto-text, and international characters.

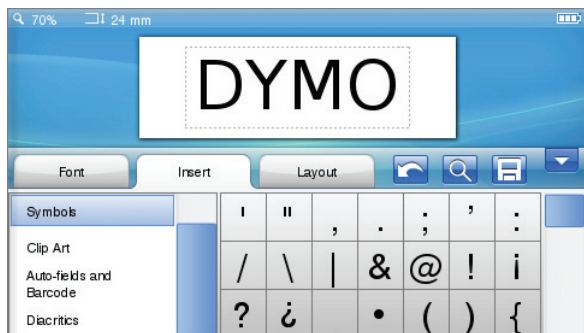

Recently used clip art and symbols are automatically added to the Favorites category. Favorites is located at the top of the Insert list.

To access the insert tab

- 1 If necessary, tap  on the Home screen.
- 2 Select the **Insert** tab.

Inserting Symbols

The label maker supports a variety of useful symbols that you can quickly add to your labels.

To insert a symbol

- 1 Select **Symbols** on the **Insert** tab.
- 2 Select the symbol to insert on your label.
 You can quickly access the punctuation symbols by pressing **, , #** or the currency symbols by pressing **€ \$ £** on the keypad.

Inserting Clip Art

The label maker includes a variety of clip art images for use on your labels.

You can also download your own custom clip art to the label maker. See **Using the Label Maker with Your Computer** on page 16 for information about downloading clip art.

To insert clip art

- 1 Select **Clip Art** on the **Insert** tab.
- 2 Select the image to insert on your label.
 A label can only contain one clip art image.

Using Auto-Numbering

You can print a series of up to 50 labels at a time using auto-numbering.

To use auto-numbering

- 1 Select **Auto-fields and Barcodes** on the **Insert** tab.
- 2 Tap **Numbering**.
The Insert Numbering dialog box appears.
- 3 Select the numbering style to use.
- 4 Select the start value for the auto-numbering.
- 5 Select the amount to increment each label.
- 6 Select the number of labels to create.
- 7 Optionally, select the **Add leading zeros** check box to include leading zeros before numbers.
- 8 Tap **OK**.

The auto-number field is inserted on the label.

The auto-number field is treated as a single character on the label. You can delete this field just as you would any other character.

See **Printing a Series of Labels** on page 13 for information about printing labels with auto-numbering.

Inserting the Date and Time

You can insert the current date and time on your label. Before inserting the date and time, you must set the current date and time in the label maker settings

To set the date

- 1 Tap  on the Home screen.
- 2 Select **Date** from the settings list.
- 3 Select the current year, month, and day.
- 4 Select the desired date format, and then tap **Done**.

To set the time

- 1 Tap  on the Home screen.
- 2 Select **Time** from the settings list.
- 3 Select the current hour and minutes.
- 4 Do one of the following:
 - To use 24-hour time format, select the **Use 24-hour time** check box.
 - To use 12-hour time format, clear the **Use 24-hour time** check box, and then select **AM** or **PM** from the list.
- 5 Tap **Done**.

To insert the date and time

- 1 Select **Auto-fields and Barcodes** on the **Insert** tab.
- 2 Tap **Date and Time**.
The Insert Date and Time dialog box appears.
- 3 To insert the date, do the following:
 - a Select the **Date** check box.
 - b Select the desired date format from the list.
- 4 To insert the time, do the following:
 - a Select the **Time** check box.
 - b Optionally, select the **Use 24-hour time** check box.
- 5 To automatically update the date and time each time the label is printed, select the **Auto-update date and time** check box.
- 6 Tap **OK**.

The date and time fields are inserted on the label.

The date and time fields are each treated as a single character on the label. You can delete these fields just as you would any other character.

Inserting Barcodes

You can print the following types of barcodes:



| | | |
|-------|------------|--------|
| UPC-A | Code 128 B | EAN 13 |
| UPC-E | Code 39 | EAN 8 |

You can choose whether or not to print the barcode text and you can choose to print the barcode text either above or below the barcode.

Optionally, you can add text before, after, above, or below the barcode.

 This User Guide assumes that you already understand the differences between barcode types and have a plan in place to incorporate barcodes into your organization. If you need to learn more about barcodes, many excellent how-to books are available at local libraries and book stores.

To insert a barcode

- 1 Select **Auto-fields and Barcodes** on the **Insert** tab.
- 2 Tap **Barcode**.
The Insert Barcode dialog box appears.
- 3 Select a barcode type from the **Barcode type** list.
- 4 Enter the data for the barcode in the **Barcode data** box.
 To insert a symbol, tap **Add symbol** and select the desired symbol.
- 5 From the **Show barcode data** list, select one of the following:
 - **Below barcode** - to place the barcode text below the barcode.
 - **Above barcode** - to place the barcode text above the barcode.
 - **Not displayed** - to not print the barcode text.
- 6 Tap **Choose layout**, and then do the following:
 - Select a size for your barcode from the **Barcode size** list.
 For best results, select **Medium**.
 - Select the desired barcode position relative to other text on the label.
- 7 Tap **OK**.
The barcode is inserted on the label.

The barcode is treated as a single character on the label. You can delete the barcode just as you would any other character.

Inserting Days, Months, or Quarters

You can automatically insert the names of days, months, or quarters on your label. When you choose to insert days, months, or quarters, a label is created for each day, month or quarter you select.

 Days, months, and quarters cannot be combined on a single label. Only one of these names can be used at a time.

To insert days, months, or quarters

- 1 Select **Auto-fields and Barcodes** on the **Insert** tab.
- 2 Tap **Days, Months, or Quarters**.
The corresponding dialog box appears.
- 3 Select the day, month, or quarter names to use.
A label is created for each day, month, or quarter you selected.
- 4 To abbreviate day, month, or quarter names, select the **Abbreviate** check box.
- 5 Tap **OK**.
The selected field is inserted on the label.

The field is treated as a single character on the label. You can delete this field just as you would any other character.

See **Printing a Series of Labels** on page 13 for information about printing labels with day, month, or quarter names.

Inserting International Characters

The label maker supports the extended Latin character set.

Pressing **Ä é ñ** followed by a letter displays all of the available variations of that letter.

For example, if you press **Ä é ñ** and then the letter **a**, you will see **à á â ã ä** and so on for all the variations available.

To insert accented characters

- 1 Press **Ä é ñ** and then press an alpha character.
The accent variations for that alpha character are displayed.
- 2 Use the left and right navigation keys to select the character you want and press **OK**.

Notes

- You can also access the accent variations for a letter by pressing and briefly holding the corresponding alpha key.
- You can also access International characters by selecting **Diacritics** on the **Insert** tab.

Using Word Suggestions

The label maker remembers words longer than five characters that you use for labels. As you enter new words on your label, words that you have previously used are automatically suggested.

To use suggested words



- 1 Enter text on your label.
If a word suggestion is available, the suggested word appears below the label in the Label Edit screen.
- 2 Tap the suggested word to insert that word on your label.

If you do not want to use the suggested word, continue typing or click **X** to close the word suggestion box.

To turn off word suggestions

- 1 Tap  on the Home screen.
- 2 Select **Word Suggestion** from the **Settings** list.
- 3 Clear the **Use word suggestion** check box.

To delete available word suggestions

- 1 Tap  on the Home screen.
- 2 Select **Word Suggestion** from the **Settings** list.
- 3 Tap **Manage words**.
The Manage words dialog box appears and all available word suggestions are displayed.
- 4 (Optional) Enter some text in the **Filter** box to filter the list of words.
- 5 Do one of the following:
 - To delete a single word from the list, tap  next to a word.
 - To delete all words from the list, tap **Delete all**, and then tap **Delete all** again when prompted.

Editing the Label Layout

Several layout options are available to enhance the appearance of your labels. You can add a border to your label, change the alignment and direction of the text, and create fixed-length labels.

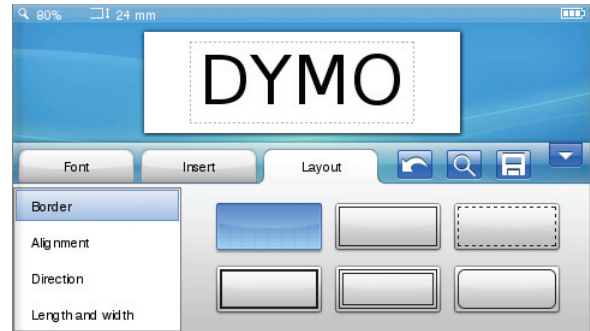

To edit your label layout

- 1 If necessary, tap  on the Home screen.
- 2 Select the **Layout** tab.

Adding Borders

You can choose from several border types to enhance your label.

Five borders are available:



When you add a border to a label, the border surrounds the entire label.

To add a border

- 1 Select **Border** on the **Layout** tab.
- 2 Select a border to use.

Aligning the Text

You can align the text to print left, centered, or right justified. The default alignment is centered.

To align the text

- 1 Select **Alignment** on the **Layout** tab.
- 2 Select desired text alignment option.

Using Mirror Text

The mirror format allows you to print text which reads from right to left, as you would see the text in a mirror.

To use mirror text

- 1 Select **Direction** on the **Layout** tab.
- 2 Tap .
The mirror format is visible in the display.

Using Vertical Text

You can print labels with the text running vertically. Labels with multiple lines of text will print as multiple columns of text.

To use vertical text

- 1 Select **Direction** on the **Layout** tab.
- 2 Tap .

The vertical format is visible in the display.

Creating Fixed-Length Labels

Normally, the length of a label is determined by the length of the text. However, you can choose to set the length of the label for a specific application. You can choose a fixed length label up to 999 mm (40") long.

To set a fixed length

- 1 Select **Length and width** on the **Layout** tab.
- 2 Select **Fixed**, and then select the label length.

Using the Label Maker Memory

The label maker has a powerful memory feature that allows you to save and organize your frequently used labels, store downloaded labels, and manage your custom clip art images.

You can create folders to keep your saved and downloaded labels organized.

Saving a Label

When you save a label, the text and all formatting are saved.

To save a label

- 1 Tap  on the Label Edit screen.
- 2 (Optional) Select the folder to save your label to.
- 3 To create a new folder for your label, do the following:
 - a Tap **New folder**.
The Create new folder dialog box appears.
 - b Enter a name for the folder in the **Folder name** box, and then tap **Create folder**.
The folder is added and selected on the Save label screen.
- 4 Enter a name for your label in the **Label name** box, and then tap **Save**.

Downloading Labels

Using DYMO Label™ software on your computer, you can create labels from a database file and download the labels to the label maker. See **Using the Label Maker with Your Computer** on page 16 for more information about creating and downloading labels.

Using Saved Labels

You can use any saved, recently printed, or downloaded labels.

To use a saved label

- 1 Tap  on the Home screen.
- 2 Navigate to and select the label to use, and then tap **Open**.

The selected label is displayed in the Label Edit screen and can be edited and printed.

Managing Labels on Your Label Maker

You can view, organize, and delete saved and downloaded labels stored on your label maker.

Viewing Saved Labels

You can quickly view all saved labels on your label maker.

To view saved or downloaded labels

- 1 Tap  on the Home screen.
- 2 Select **Manage Files** from the **Settings** list.
- 3 Tap one of the following:
 - **Saved labels** - to view all saved labels.
 - **Downloaded labels** - to view all downloaded labels.

Creating New Folders

You can create folders to keep your saved and downloaded labels organized.

To create a new folder

- 1 Tap **New folder**.
The Create new folder dialog box appears.
- 2 Enter a name for the folder in the **Folder name** box, and then tap **Create folder**.

Deleting Labels and Folders

You can delete saved or downloaded labels and folders at any time.

To delete labels and folders

- 1 Select the check box next to each label or folder you want to delete.
- 2 Tap **Delete**.
A message appears asking if you want to delete the selected items.
- 3 Tap **Yes**.
The selected labels and folders are permanently deleted.

Editing Labels and Folders

You can rename, cut, copy, and paste labels and folders to keep your labels organized.

To rename a label or folder

- 1 Select the check box next to the label or folder you want to rename.
- 2 Tap **Edit**, and then tap **Rename**.
The Rename dialog box appears.
- 3 Enter a new name for the label or folder in the **New name** box, and then tap **Rename**.

To cut or copy labels and folders

- 1 Select the check box next to each label or folder you want to cut or copy.
- 2 Tap **Edit**, and then tap one of the following:
 - **Cut** - to cut the labels and folders
 - **Copy** - to copy the labels and folders

To paste labels and folders

- 1 Cut or copy the labels or folders you want to paste.
- 2 Navigate to the folder where you want to paste the labels or folders.
- 3 Tap **Edit**, and then tap **Paste**.
The labels or folders are pasted to the selected location.

Clearing Recently Printed Labels

You can quickly clear all recently printed labels from the label maker memory.

 Clearing recently printed labels clears this list of labels for all users.

To clear recently printed labels



- 1 Tap  on the Home screen.
- 2 Select **Manage Files** from the **Settings** list.
- 3 Tap **Clear recently printed**.
A message appears asking if you want to delete recently printed labels for all users.
- 4 Tap **Yes**.

Managing Custom Clip Art

You can delete custom clip art images that you previously downloaded to your label maker.

See **Using the Label Maker with Your Computer** on page 16 for more information about downloading clip art.

To delete custom clip art

- 1 Tap  on the Home screen.
- 2 Select **Manage Files** from the **Settings** list.
- 3 Tap **Downloaded Clip Art**.
The Manage downloaded Clip Art screen is displayed.
- 4 Select the images to delete.
 To select all images, tap **Select all**.
- 5 Tap **Delete**.
A message appears asking if you want to delete the selected images.
- 6 Tap **Delete**.

Printing Options

You can choose to print multiple copies of the same label. By default, each label is automatically cut after printing. However, you can choose to turn this auto-cut feature off. If you turn off the auto-cut feature, you can also choose whether or not to print cut marks between each label.

Printing a Series of Labels

You can create a series of labels by using auto-numbering or by inserting day, month, or quarter names on your labels.

For more information about using these features, see **Using Auto-Numbering and Inserting Days, Months, or Quarters** on page 10.

 You cannot print multiple copies of a series of labels.

To print a series of labels

- 1 Create a series of labels by using auto-numbering or by inserting day, month, or quarter names on your label.
- 2 Press .
- 3 The Print preview screen appears.
- 3 Swipe to the left or right to view each label in the series.
- 4 Tap **Print**.

Printing Multiple Copies

You can print up to 49 copies of a single label at one time.

To print multiple copies

- 1 Press .
- 1 The Print preview screen appears.
- 2 Select the number of copies to print in the **Number of copies** box.
- 3 Tap **Print**.

Turning off Auto-Cut

When the auto-cut feature is turned on, each label is automatically cut after printing. This feature is on by default. However, you can turn off auto-cut.

To turn off auto-cut

- 1 Tap  on the Home screen.
- 2 Select **Label** from the **Settings** list.
- 3 Clear the **Cut each label after printing** check box.

Printing Cut Marks Between Labels

When auto-cut is off, you can choose to print a label separator cut mark between each label to indicate where the labels should be cut.

To print cut marks between labels

- 1 Tap  on the Home screen.
- 2 Select **Label** from the **Settings** list.
- 3 If necessary, clear the **Cut each label after printing** check box.
- 4 Select the **Print cut marks between labels** check box.

Customizing Your Label Maker

Several options are available for customizing your label maker. You can choose the display language, units of measure, label width, default font, and screen settings.

Changing the Language

You can change the display language for the label maker so that you can work in a language that is most familiar to you.

To change the language

- 1 Tap  on the Home screen.
- 2 Select **Language** from the **Settings** list.
- 3 Select the desired language from the **Set language** list, and then tap **Done**.

Changing the Units of Measure

You can choose to work in English (Inches) or Metric units. Metric is selected by default.

To change the units of measure

- 1 Tap  on the Home screen.
- 2 Select **Units of Measure** from the **Settings** list.
- 3 Select **Metric (mm)** or **Inches**, and then tap **Done**.

Changing the Label Width

Each time you insert a label cassette into the label maker, you are prompted to set the label width so the label maker knows what size label you are currently using. Some of the features available for designing labels depend on the width of the label. You can change the label width setting at any time, regardless of what label cassette is actually inserted in the label maker.

To change the label width

- 1 Tap  on the Home screen.
- 2 Select **Label** from the **Settings** list.
- 3 Select the width of the label currently inserted in the printer from the **Label width** list, and then tap **Done**.
The label in the Label Edit screen changes to the new width.

Changing the Default Font

You can select the default font type, size, and style to use for all your labels. You can easily change the font for individual labels from the Label Edit screen.

To change the default font

- 1 Tap  on the Home screen.
- 2 Select **Font** from the **Settings** list.
- 3 Select the font type, size, and style to use as the default font, and then tap **Done**.

Changing the Screen Settings

You can adjust the screen brightness and choose whether or not to show the clock when the label maker is in standby mode and the charging adapter is connected.

To change the screen brightness

- 1 Tap  on the Home screen.
- 2 Select **Screen** from the **Settings** list.
- 3 Under **Screen brightness**, move the slider right or left to increase or decrease the screen brightness.
- 4 Tap **Done**.

To turn off the clock

- 1 Tap  on the Home screen.
- 2 Select **Screen** from the **Settings** list.
- 3 Clear the **Show clock while charging** check box, and then tap **Done**.



Working with User Accounts

You can create user accounts on the label maker for different users. Each user can then select their own default settings for the label maker.

Creating User Accounts

You can create up to five user accounts.

To create a user account

- 1 Tap  on the Home screen.
- 2 Tap  **New user**.
The User settings dialog box appears.
- 3 Enter a name for the new user in the **User name** box.
- 4 Select the settings for the new user.
See **Changing User Settings** on page 15 for information about selecting user settings.
- 5 Tap **Save**.

Changing User Settings

You can set the language, date and time format, units of measure, font, and word suggestion settings for each user individually.

To change user settings

- 1 Tap  on the Home screen.
- 2 Select the user to change the settings for, and then tap **Settings**.
- 3 For each setting you want to make changes to, do the following:
 - a Select the setting to make changes to from the **User settings** list.
 - b Make the desired changes to the selected setting.
- 4 Tap **Save**.

Deleting User Accounts

When you no longer need a user account, you can delete that user account from the label maker.

 You cannot delete the Default user account.

To delete a user account

- 1 Tap  on the Home screen.
- 2 Select the user to delete.
- 3 Tap **Delete**.

A message appears asking if you want to delete the user.
- 4 Tap **Yes**.

Maintaining Your Label Maker

Your label maker is designed to give you long and trouble-free service, while requiring very little maintenance.

Clean your label maker and calibrate the screen regularly to keep your label maker working properly.

Cleaning Your Label Maker

Clean your label maker regularly to keep it working properly.

To clean the touch screen

- 1 Use a lint-free cloth to wipe the exterior of the printer and the touch screen.

 Do not press on the touch screen with any hard object, such as a fingernail.
- 2 If necessary, use ethanol to remove dirt and smudges.

 Do not use alkaline detergents, including glass cleaner, nail polish remover, benzene, or other organic solvents.

To clean the print head

- 1 Remove the label cassette.
- 2 Remove the print head cleaning tool from inside the label compartment cover.

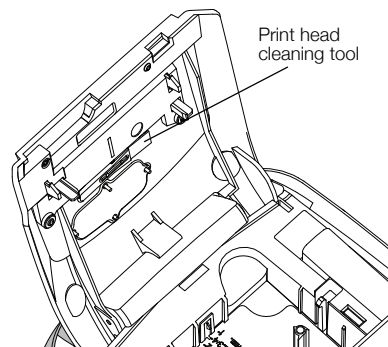

- 3 Gently wipe the padded side of the tool across the print head.

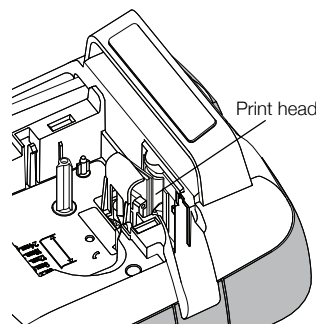

Calibrating the Touch Screen

From time to time you may need to calibrate the touch screen display to keep it working properly.

To calibrate the screen

- 1 Tap  on the Home screen.
- 2 Select **Screen** from the **Settings** list.
- 3 Tap **Calibrate screen**.
- 4 When prompted to start calibration, tap **Start**.
- 5 Tap the center of each of the crosses as they appear on the screen.

Using the Label Maker with Your Computer

Your label maker can be used as a standalone label printer or you can print labels directly from your computer using DYMO Label™ software (requires DYMO Label v.8.4 or later).

You can also use DYMO Label software to do the following:

- Create and download labels by importing data from a number of standard database formats.
- Download your own custom clip art to your label maker.
- Manage labels and clip art on the label maker.

Installing DYMO Label Software

Do not connect the label maker to your computer until prompted by the installer.

To install the software on a Windows® system

- 1 Download the latest version of DYMO Label software from the Support section of the DYMO Web site at www.dymo.com.
- 2 Close all open Microsoft Office applications.
- 3 Double-click the Installer icon.
After a few seconds, the installation screen appears.
- 4 Click **Install** and follow the instructions in the installer.

To install the software on a Mac OS® system

- 1 Download the latest version of DYMO Label software from the Support section of the DYMO Web site at www.dymo.com.
- 2 Double-click the Installer icon and follow the on-screen instructions.

Connecting the Label Maker to Your Computer

The label maker connects to your computer using the USB connector located on the top of the label maker.



Do not connect the label maker to your computer until prompted by the installer.

To connect the label maker to your computer

- 1 Plug the USB cable into the USB connector at the top of the label maker.

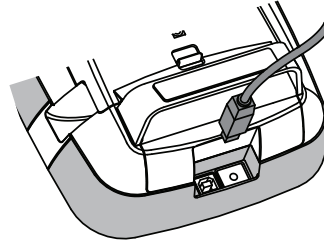

- 2 Plug the other end of the USB cable into an available USB port on your computer.
- 3 If necessary, press  to turn on the label maker.
- 4 If you have more than one DYMO label printer installed, do the following:
 - a Click the printer image in the DYMO Label software Print area.



All of the label printers that are installed on your computer are displayed.

- b Select the **LabelManager 500TS** label maker.

Using DYMO Label Software

The following figure shows some of the major features available in DYMO Label software.

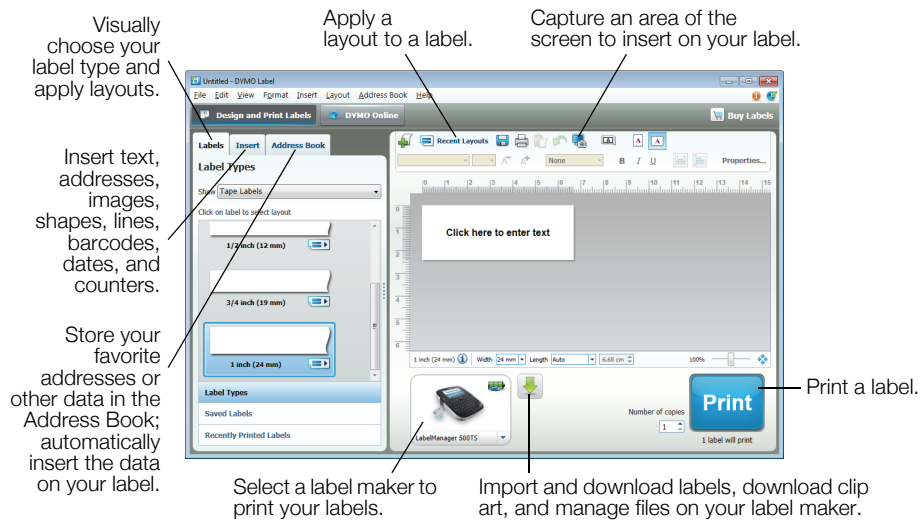







For complete details on using the software, refer to the online Help.

From the Help menu, you can view the following:

- DYMO Label v.8 Help
- DYMO Label v.8 User Guide
- LabelManager 500TS User Guide

Viewing the Label Maker Status

The label maker status is displayed in the DYMO Label software Print area. The following table describes the possible states of the label maker.

| | |
|---|---|
|  | Label maker is connected and battery pack is charging |
|  | Label maker is connected and battery pack is charging; printing is not possible |
|  | Label maker is connected and battery pack is not charging |
|  | Label maker is connected and battery pack is not charging; printing is not possible |
|  | Label maker is not connected or is turned off |
|  | Label maker is connected and there is a problem with the battery pack |

Troubleshooting

Review the following possible solutions if you encounter a problem while using your label maker.

| Problem/Error Message | Solution |
|---|--|
| No display | <ul style="list-style-type: none"> ■ Ensure the label maker is turned on. ■ Attach the charging adapter to the label maker to recharge the battery pack. See Charging the Battery Pack. |
| Poor Print Quality | <ul style="list-style-type: none"> ■ Attach the charging adapter to the label maker to recharge the battery pack. See Charging the Battery Pack. ■ Clean the print head. See Cleaning Your Label Maker. ■ Ensure the label cassette is installed properly. ■ Replace the label cassette. |
| No label cassette inserted | Insert a label cassette. |
| Text exceeds printable area | <ul style="list-style-type: none"> ■ Delete some or all of the buffer text. ■ Decrease the font size. ■ Select the Auto-fit text check box on the Font tab of the Label Edit screen. ■ Delete lines to fit on the label width. ■ Insert a wider label cassette. |
| Battery level is low | <ul style="list-style-type: none"> ■ Attach the charging adapter to the label maker to recharge the battery pack. See Charging the Battery Pack. ■ Ensure the battery pack is inserted correctly. See Inserting the Battery Pack. ■ Replace the battery pack. |
| Label jam | <ul style="list-style-type: none"> ■ Remove jammed label; replace label cassette. ■ Clean cutter blade. |
| Cutter jam | <ul style="list-style-type: none"> ■ Remove jammed label; replace label cassette. ■ Clean cutter blade. |
| Unable to print | Insert the battery pack and try again. See Inserting the Battery Pack . |
| How do I remove the backing from the label? | <p>DYMO labels have an easy-to-peel split back.</p> <ol style="list-style-type: none"> 1 Locate the split on the label backing. 2 Gently pinch the label lengthwise, folding toward the printed side of the label. The label backing will separate. 3 Carefully peel away the backing from the label. |

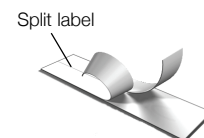

If you need further assistance, visit the DYMO Web site at www.dymo.com.

Documentation Feedback

We are constantly working to produce the highest quality documentation for our products. We welcome your feedback. Send us your comments or suggestions about our user guides. Please include the following information with your feedback:

- Product name, model number, and User Guide page number
- Brief description of instructions that are inaccurate or unclear, areas where more detail is needed, and so on

We also welcome your suggestions about additional topics you would like to see covered in the documentation.

Send email messages to: documentation@dymo.com

Please keep in mind that this email address is only for documentation feedback. If you have a technical question, please contact Customer Support.

Safety Precautions for Lithium Polymer Rechargeable Battery Pack

Inaccurate handling of a Lithium Polymer rechargeable battery may cause leakage, heat, smoke, an explosion, or fire. This could cause deterioration of performance or failure. This may also damage the protection device installed in the battery pack. This could damage equipment or injure users. Thoroughly follow the instructions below.

While Charging the Battery Pack

Danger

- When charging the battery pack, use dedicated chargers and follow the specified conditions.
- Do not connect directly to an electric outlet or cigarette lighter charger.
- Do not use or store battery pack close to fire or inside the car where temperature may be over 60°C (140°F).

Warning

- Stop charging the battery pack if charging is not completed within the specified time.

Caution

- Thoroughly read this User Guide before charging the battery pack.
- Do not charge in a place that generates static electricity.
- Battery pack can only be charged within 0°C~45°C (32°F~113°F) temperature range.

When Discharging the Battery Pack

Danger

- Use the battery pack only in the specified equipment.
- Do not use or store battery pack close to fire or inside the car where temperature may be over 60°C (140°F).

Caution

- Do not charge in a place that generates static electricity.
- Battery pack can only be used within -20°C~60°C (-4°F~140°F) temperature range.

Environmental Information

The equipment that you have bought requires the extraction and use of natural resources for its production. It may contain substances that are hazardous to health and the environment.

In order to avoid the dissemination of those substances in our environment, and to diminish the pressure on natural resources, we encourage you to use the appropriate take-back systems. These systems will reuse or recycle most of the materials of your end-of-life equipment in an environmentally sound way.

The crossed-bin symbol marked on your device indicates you should use these systems.



If you need more information on the collection, reuse, and recycling of this product, please contact your local or regional waste administration.

You can also contact DYMO for more information on the environmental performance of our products.