

European Community Design Registration RCD 000929971



Dispenser

Soap

Liquid Mini

S2 System



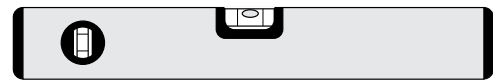
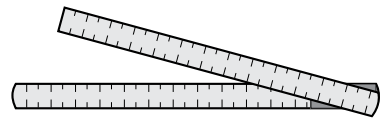
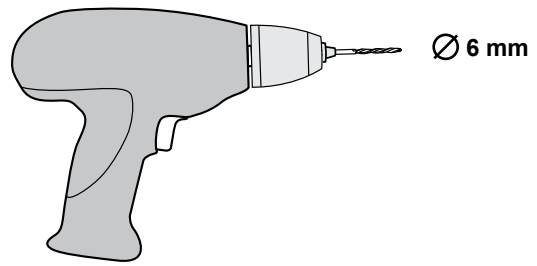
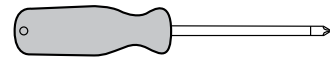
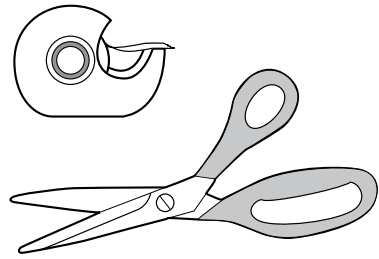
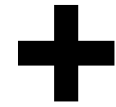
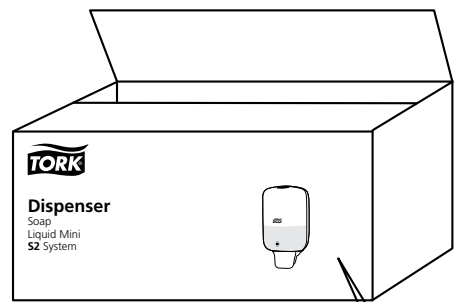

x 1

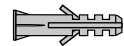

x 4



x 4

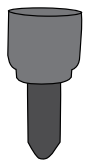

x 1

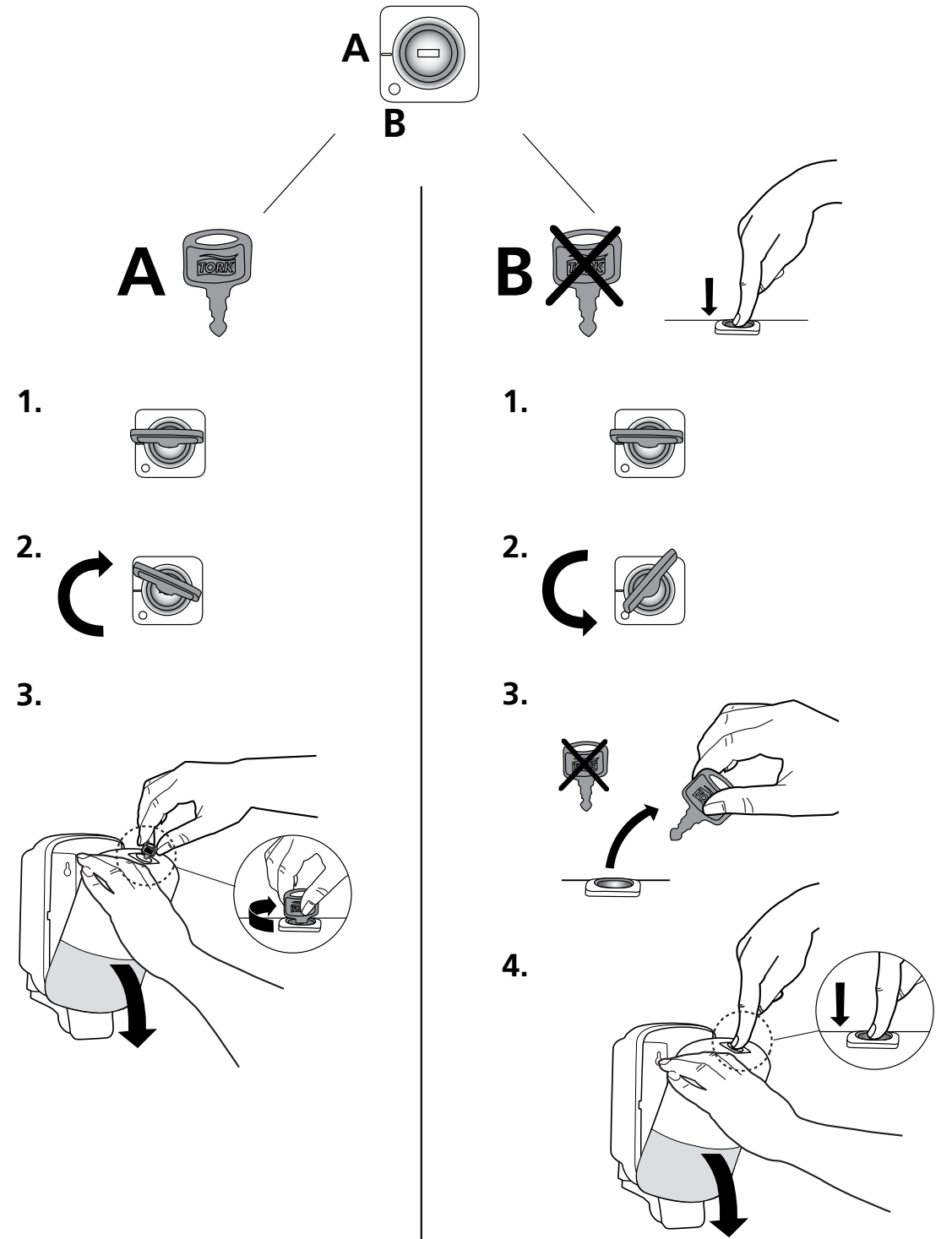
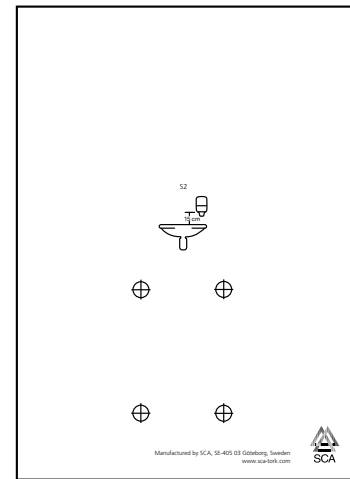
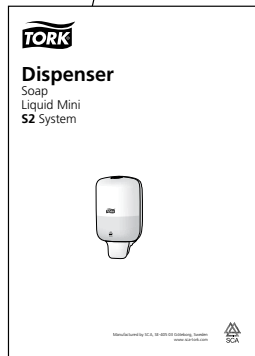
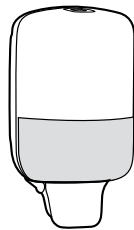

3.

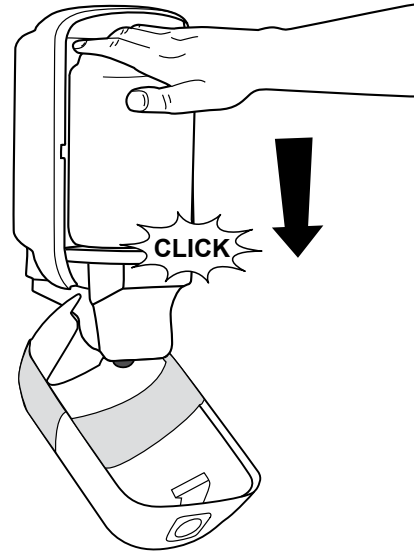

4.

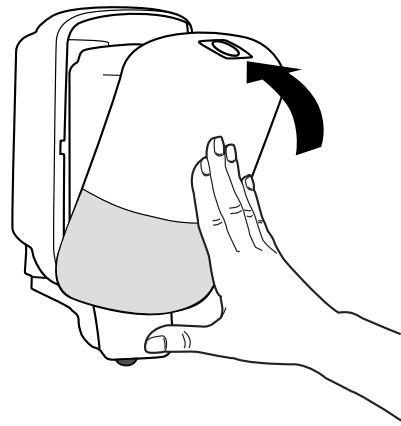

5.

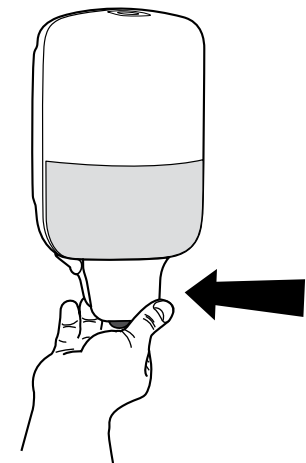

1.

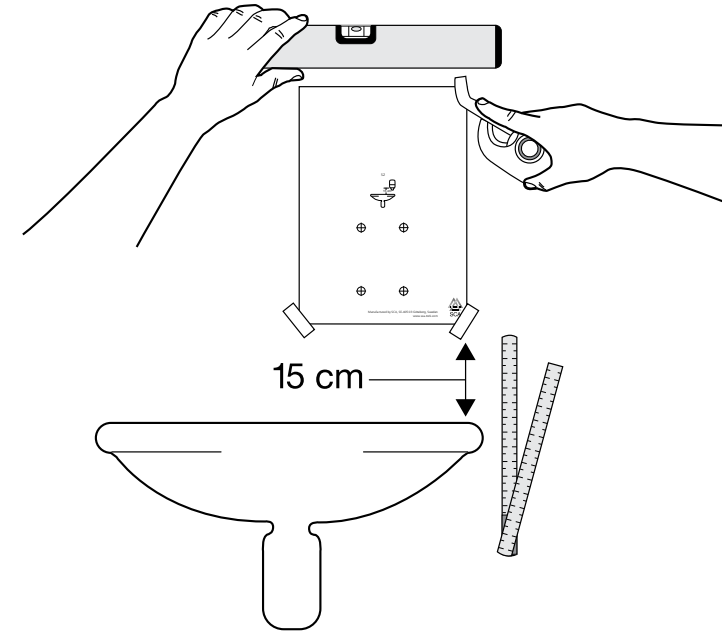

2.

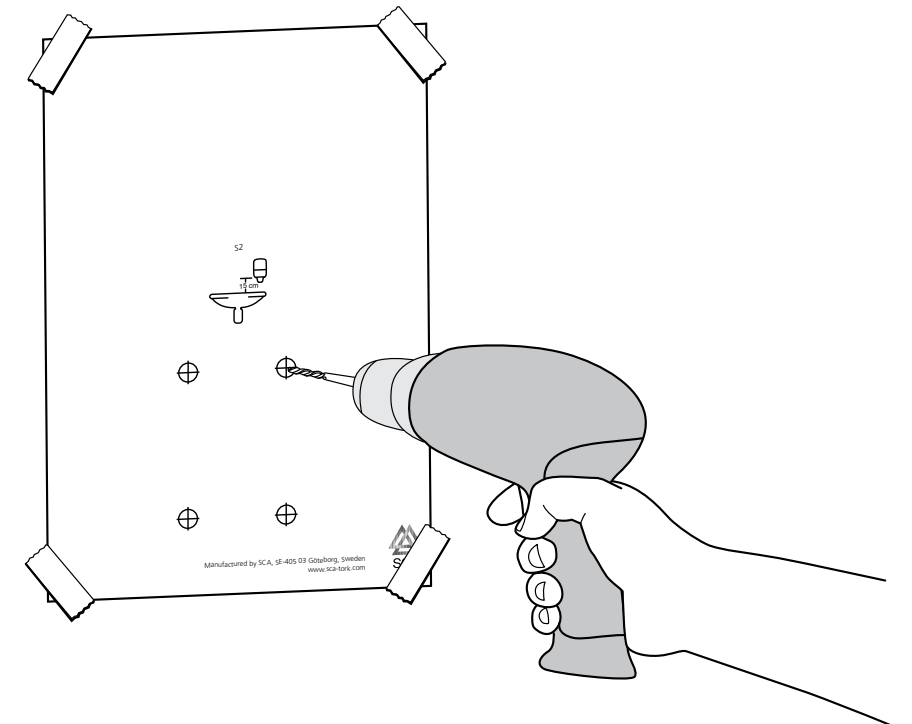

3.

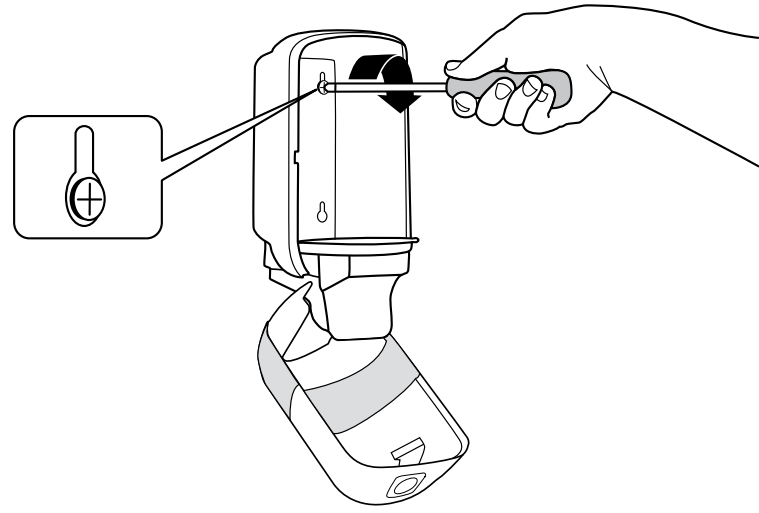
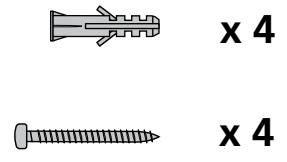

4.

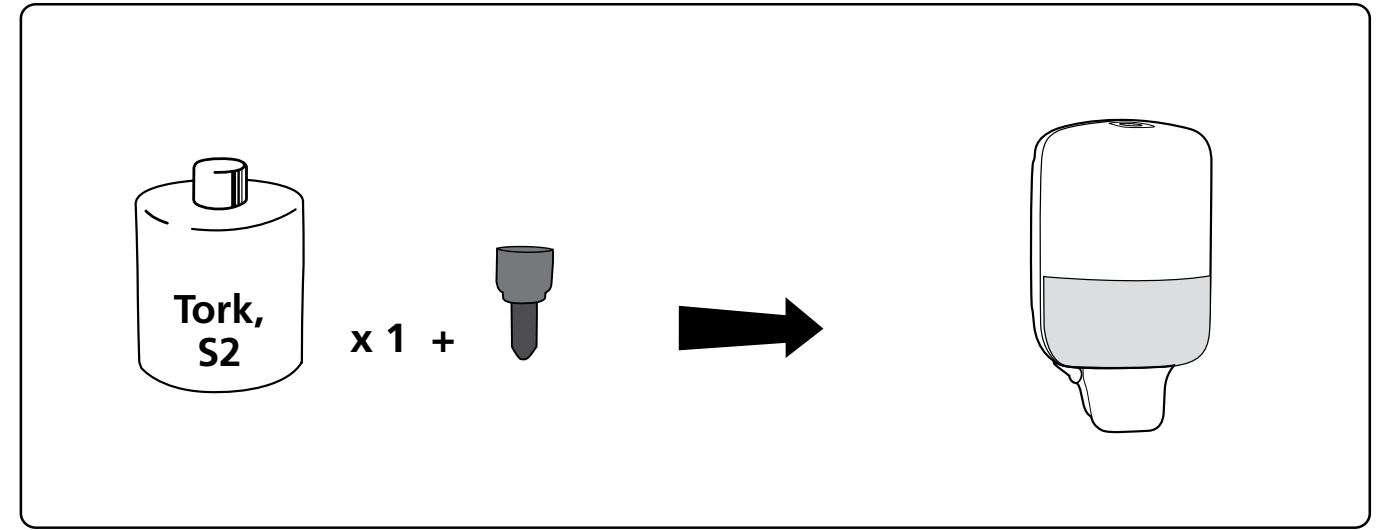
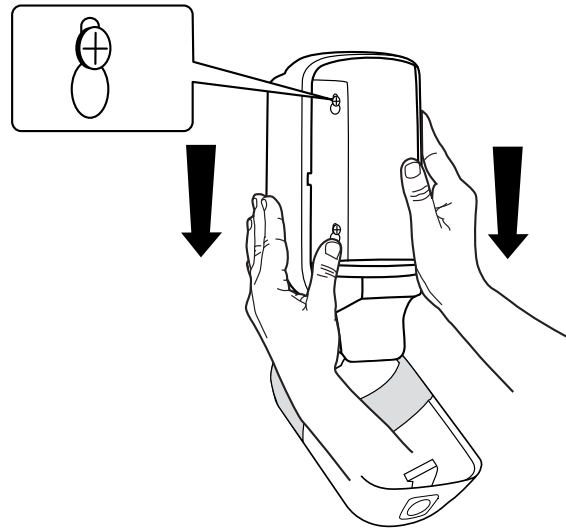

1.

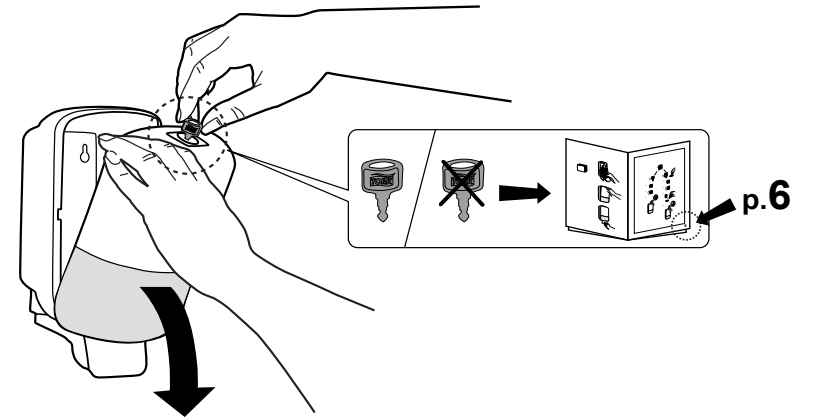

2.

