

**EW-7438RPn**

# Quick Installation Guide

06-2012 / v1.2

## PRODUCT INTRODUCTION



### Package Contents



Before you start using this product, please check if there is anything missing in the package, and contact your dealer to claim the missing item(s):

- 1 x Wi-Fi extender
- 1 x Ethernet cable
- 1 x Access key card
- 1 x Quick installation guide
- 1 x CD with user manual and multi-language QIG

### LED Indicators



LED Name		LED Status	Description
	Signal Strength	On	Excellent signal reception (Signal strength 50 – 100%)
		Flashing	Good signal reception (Signal strength 25 – 50%)
		Flashing Rapidly	Poor signal reception (Signal strength < 25%)
		Off	No signal detected, disconnected, or in LED off mode
	Wi-Fi	Flashing	Transferring data
		Off	Wi-Fi not activated or in LED off mode

	Power	On	Device switched on and correctly powered
		Flashing	Resetting to factory defaults
		Off	Device not powered, not correctly powered, or in LED off mode
	WPS	On	WPS connection established
		Flashing	WPS in progress (waiting for another WPS device's connection)
		Flashing Rapidly	WPS error
		Off	No WPS connection established or in LED off mode
	LAN	On	LAN port connected
		Flashing	LAN activity (transferring data)
		Off	LAN port not connected



## GETTING STARTED

It is recommended that you first set up this extender somewhere close to the root wireless access point, and then move this extender to another location for optimal Wi-Fi extension.

### Section A: Setting Up the Wi-Fi Extender with the WPS Button



**Note:** If your root wireless access point does not have a WPS button or if you cannot set up a WPS connection properly, please refer to **Section B: Setting Up the Wi-Fi Extender with a Computer.**

1. Plug the Wi-Fi extender into a power outlet close to the root wireless access point and switch it on (1). The extender will automatically initialize. In a few seconds, the Power LED (  ) will light up. Approximately 30 seconds afterwards, the Wi-Fi LED (  ) will begin to flash rapidly and irregularly (2). This indicates initialization is complete. Please do not proceed to step 2 until these conditions are fulfilled.

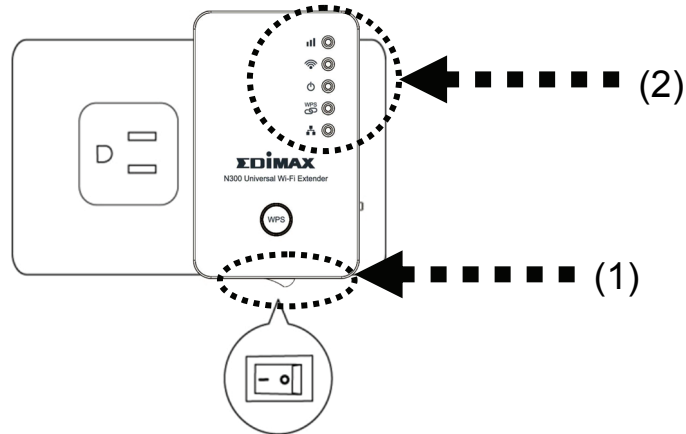

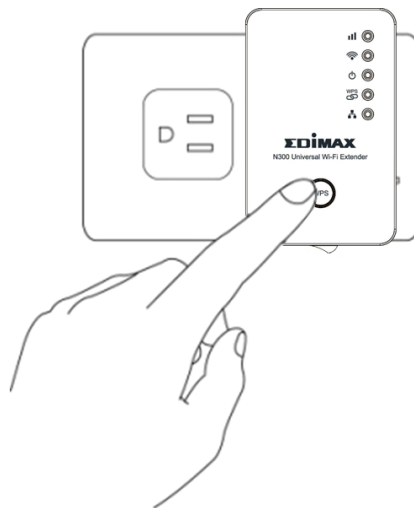

2. Press and hold the WPS button on the extender for 2 seconds, until the WPS LED (  ) starts flashing.

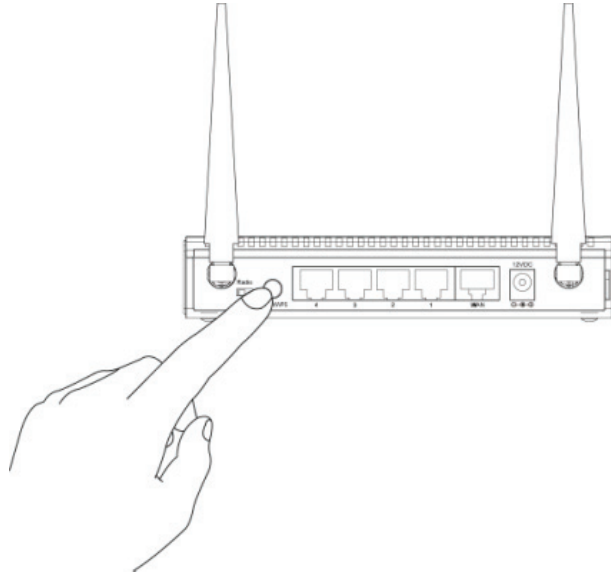

3. Press the WPS button on the root wireless access point within 2 minutes to establish a connection. The amount of time the button should be held down will vary between different routers, some will work with a quick press, while others may require holding the button down for 2 seconds or more.





**Note:** Some wireless routers may **reboot** if the WPS button is held down for too long. To prevent accidentally rebooting your router, please refer to your router user manual for detailed instructions regarding WPS operation.

4. The WPS LED (  ) will go through a series of flashes over the next 60 to 90 seconds. When a WPS connection has been successfully established, the green WPS LED (  ) will stay on, and the Signal Strength LED (  ) will light up in orange.



**Troubleshooting:** If the WPS LED (  ) continues to blink in regular two-second intervals 30 seconds after pressing the WPS button on the access point, then the Wi-Fi extender did not detect the WPS signal from the access point. Please return to step 3.

If an error occurred, the WPS LED (  ) will flash rapidly. Please wait for the WPS LED to deactivate and try again from step 1.

5 minutes after a WPS connection has been established, the WPS LED (  ) will automatically deactivate. The WPS connection between the extender and the wireless access point will remain active.

5. You may test the connectivity of the Wi-Fi extender by connecting to it (select its SSID from your list of wireless networks, **not** the SSID of your

root wireless access point) and attempting to open a web page with your web browser.

6. After you have connected the extender to the existing Wi-Fi network and confirmed it works, you can move this extender to another location for optimal Wi-Fi extension. To move the extender, turn off the device and unplug it from its socket. The extender will remember the Wi-Fi network it is assigned to. Move the extender to its new location and plug it in, then turn the device on again. The extender will go through its initialization process after being turned on. You will be unable to connect to the extender while it is initializing. When the green Wi-Fi LED (📶) begins flashing irregularly and the orange Signal Strength LED (📶) activates, the extender is ready for use.

For best results, install the extender at a location where the Signal Strength LED (📶) remains on without blinking. This indicates the extender is receiving a strong signal from the root wireless access point.

## Section B: Setting Up the Wi-Fi Extender with a Computer

1. First make sure that your computer is a DHCP client (it obtains its IP automatically from a DHCP server). If you are unsure, please refer to the User Manual on the enclosed CD.
2. Plug the Wi-Fi extender into a power outlet close to the root wireless access point and switch it on (1). The extender will automatically initialize. In a few seconds, the Power LED (🔌) will light up. Approximately 30 seconds afterwards, the Wi-Fi LED (📶) will begin to flash rapidly and irregularly (2). This indicates initialization is complete. Please do not proceed to step 3 until these conditions are fulfilled.

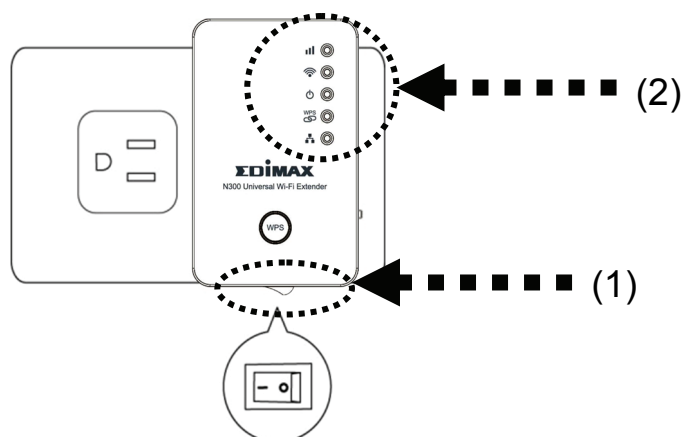

3. There are two ways to connect to the Wi-Fi extender. The first is a wired connection, using an Ethernet cable (i). The second is to connect wirelessly (ii).

- i. To connect your computer to the extender with an Ethernet cable, plug one end of the cable into the Wi-Fi extender's Ethernet port. Plug the other end of the cable into your computer's Ethernet port. Please proceed to step 4 when done.

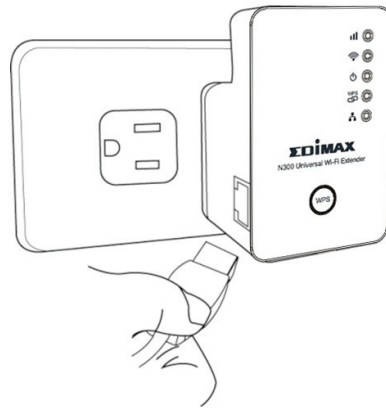

- ii. To connect your computer to the extender through a wireless connection, search for the available Wi-Fi networks in the area and look for “extender\*\*\*\*\*”, where \*\*\*\*\* is a series of numbers and letters. For example, here you would connect to “extender3a8270”:



**Note:** If you are using Windows 7 and the following appears, please click “Connect the network without setting it up”. Please do not click “OK”.

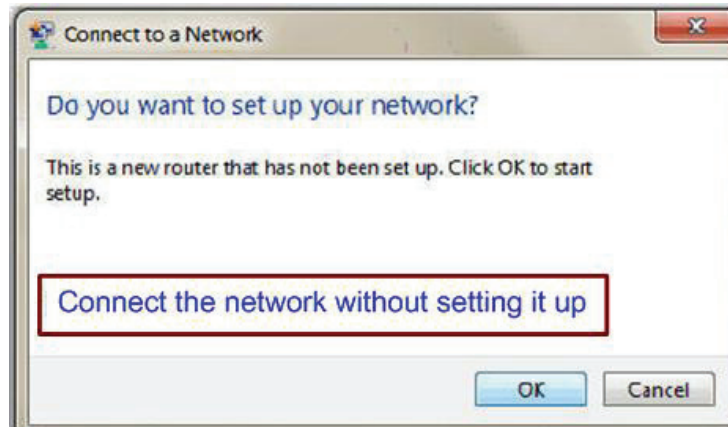

If you have accidentally clicked “OK”, you will see the following. Please click “Cancel”.



4. Now you should be connected to the Wi-Fi extender. There are two ways to access the extender’s web configuration interface:

Method 1: Open your web browser and input the access key into the address bar to log in to the extender’s web configuration interface.

**(Windows PCs only)**



**Note:** The access key can be found on the access key card in the box and on the Wi-Fi extender.



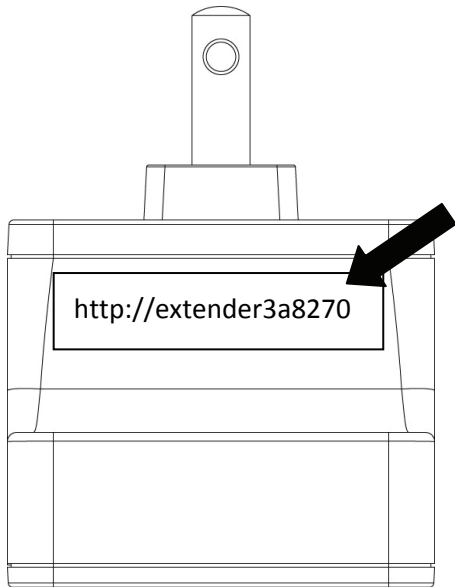

Method 2: Enter the extender's default IP address (192.168.2.2) into your browser's address bar. **(Windows, Macintosh, and Linux)**

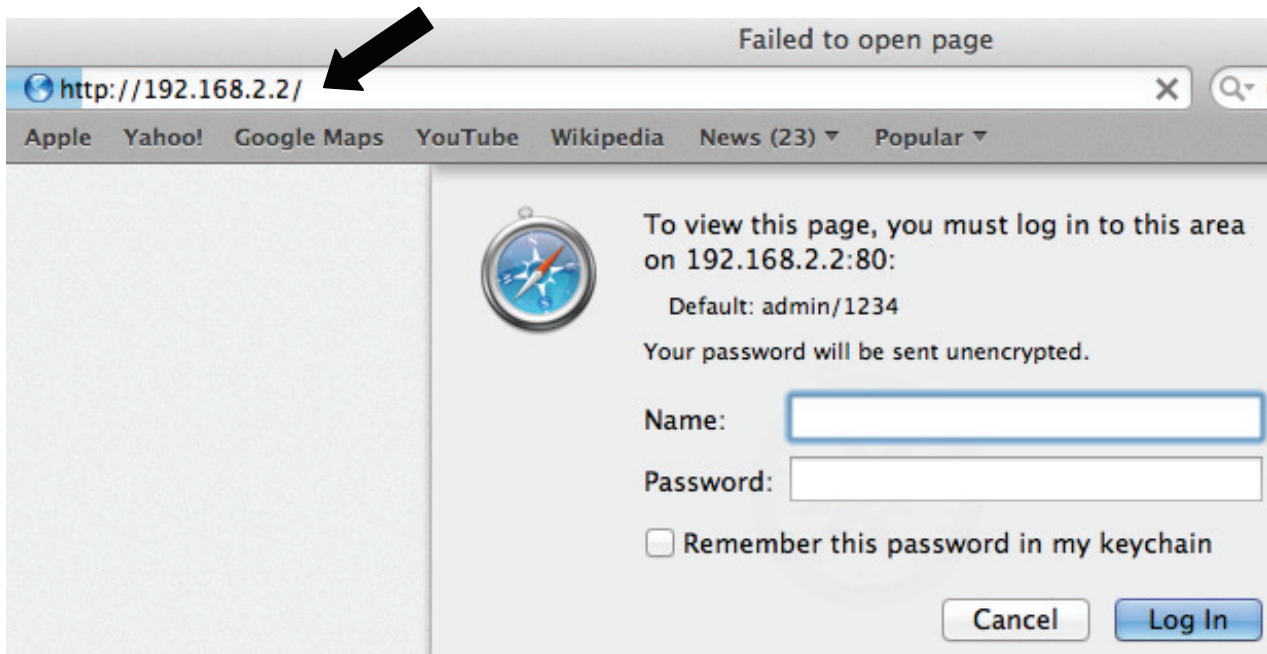

5. You will then be prompted to log in. The default username is "admin" and the default password is "1234". Click "OK" to continue.

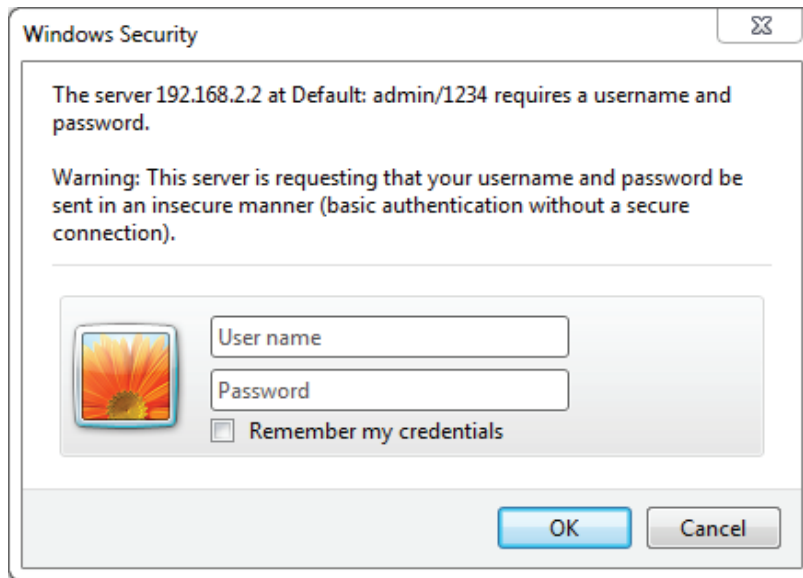

6. iQ Setup will start detecting available Wi-Fi networks automatically. All detected Wi-Fi networks will be displayed in the list. Select the one you wish to connect to.

**iQ Setup**

Please connect this device to one of the following Wi-Fi networks.

Select	SSID	Channel	Encryption	Signal
<input type="radio"/>	Edimax	11	WPA2-PSK	80



**Note:** If the Wi-Fi network you wish to connect to does not appear, click “Refresh” to detect again or try to move the extender closer to the root wireless access point.

7. Input the password of the existing Wi-Fi network in the “Key” field and click “Next” to continue. The extender must have the same Wi-Fi password as the root wireless access point.

**iQ Setup**

Please connect this device to one of the following Wi-Fi networks.

Select	SSID	Channel	Encryption	Signal
<input checked="" type="radio"/>	Edimax	11	WPA2-PSK	80
Device SSID:		Edimax3A7E46		
Key:		12345678		



**Note:** The extender will be unable to connect to the Wi-Fi network if you enter the wrong password. If you do not know your Wi-Fi password, you may find it via your Wi-Fi router's configuration, or consult the network administrator who set up the Wi-Fi network.

8. By default, the extender's SSID is the root access point's SSID plus the last six characters of the extender's access key. You can change the extender's SSID if you want. Click "Next" to complete the setup.
9. The Wi-Fi extender will test the connection between the device and the root wireless access point. If the connection is successful, the message "Connection Test Successfully" will appear on-screen. Click "Next" to save settings.

If the connection failed, the message "Connection Test Failed" will appear on-screen. Click "BACK" to restart the setup process.

10. The extender will show a brief summary of the name of the root wireless access point, the name of the extender, and the security type used. Click "APPLY" to continue, or click "BACK" to restart the setup process.

### Settings saved successfully!

Please click APPLY to restart the system and make the changes take effect.

Connected Device Name : **Edimax**

Extender Name : **Edimax3A7E46**

Security Type: **WPA-shared key**

BACK

APPLY

11. After you click "APPLY" the extender will restart and save its settings. You will see a final congratulations page. Your computer will be disconnected from the extender at this time. To reconnect to the extender, select its SSID from your list of Wi-Fi networks.

### Congratulation! Your extender is connected.

Extender Name : **Edimax3A7E46**

Security Key : **12345678**

12. You may test the connectivity of the Wi-Fi extender by connecting to it (select its SSID from your list of wireless networks, **not** the SSID of your root Wi-Fi access point) and attempting to open a web page with your web browser.
13. After you have connected the extender to the existing Wi-Fi network and confirmed it works, you can move this extender to another location for optimal Wi-Fi extension. To move the extender, turn off the device and unplug it from its socket. The extender will remember the Wi-Fi network it is assigned to. Move the extender to its new location and plug it in, then turn the device on again. The extender will go through its initialization process after being turned on. You will be unable to connect to the extender while it is initializing. When the green Wi-Fi LED (📶) begins flashing irregularly and the orange Signal Strength LED (📶) activates, the extender is ready for use.

For best results, install the extender at a location where the Signal Strength LED (📶) remains on without blinking. This indicates it is receiving a strong signal from the root wireless access point.

## Resetting the Wi-Fi Extender

If your Wi-Fi extender is not functioning correctly, or if you want to run iQ Setup again, press and hold the WPS button for 10 seconds to reset the extender to factory defaults. The Power LED (🔌) will flash when the device begins the process of resetting to factory defaults. When the Power LED (🔌) stays on and the Wi-Fi LED (📶) begins flashing irregularly, the Wi-Fi extender has returned to factory default settings and is ready for setup.



**Note:** Releasing the WPS button too soon may result in unintended behavior, such as the extender attempting to begin WPS setup.

## Federal Communication Commission Interference Statement

This equipment has been tested and found to comply with the limits for a Class B digital device, pursuant to Part 15 of FCC Rules. These limits are designed to provide reasonable protection against harmful interference in a residential installation. This equipment generates, uses, and can radiate radio frequency energy and, if not installed and used in accordance with the instructions, may cause harmful interference to radio communications. However, there is no guarantee that interference will not occur in a particular installation. If this equipment does cause harmful interference to radio or television reception, which can be determined by turning the equipment off and on, the user is encouraged to try to correct the interference by one or more of the following measures:

1. Reorient or relocate the receiving antenna.
2. Increase the separation between the equipment and receiver.
3. Connect the equipment into an outlet on a circuit different from that to which the receiver is connected.
4. Consult the dealer or an experienced radio technician for help.

### FCC Caution

This device and its antenna must not be co-located or operating in conjunction with any other antenna or transmitter. This device complies with Part 15 of the FCC Rules. Operation is subject to the following two conditions: (1) this device may not cause harmful interference, and (2) this device must accept any interference received, including interference that may cause undesired operation. Any changes or modifications not expressly approved by the party responsible for compliance could void the authority to operate equipment.

### Federal Communications Commission (FCC) Radiation Exposure Statement

This equipment complies with FCC radiation exposure set forth for an uncontrolled environment. In order to avoid the possibility of exceeding the FCC radio frequency exposure limits, human proximity to the antenna shall not be less than 2.5cm (1 inch) during normal operation.

### Federal Communications Commission (FCC) RF Exposure Requirements

SAR compliance has been established in the laptop computer(s) configurations with PCMCIA slot on the side near the center, as tested in the application for certification, and can be used in laptop computer(s) with substantially similar physical dimensions, construction, and electrical and RF characteristics. Use in other devices such as PDAs or lap pads is not authorized. This transmitter is restricted for use with the specific antenna tested in the application for certification. The antenna(s) used for this transmitter must not be co-located or operating in conjunction with any other antenna or transmitter.

### R&TTE Compliance Statement

This equipment complies with all the requirements of DIRECTIVE 1999/5/EC OF THE EUROPEAN PARLIAMENT AND THE COUNCIL of March 9, 1999 on radio equipment and telecommunication terminal equipment and the mutual recognition of their conformity (R&TTE). The R&TTE Directive repeals and replaces in the directive 98/13/EEC (Telecommunications Terminal Equipment and Satellite Earth Station Equipment) As of April 8, 2000.

### Safety

This equipment is designed with the utmost care for the safety of those who install and use it. However, special attention must be paid to the dangers of electric shock and static electricity when working with electrical equipment. All guidelines of this and of the computer manufacture must therefore be allowed at all times to ensure the safe use of the equipment.

### EU Countries Intended for Use

The ETSI version of this device is intended for home and office use in Austria, Belgium, Bulgaria, Cyprus, Czech, Denmark, Estonia, Finland, France, Germany, Greece, Hungary, Ireland, Italy, Latvia, Lithuania, Luxembourg, Malta, Netherlands, Poland, Portugal, Romania, Slovakia, Slovenia, Spain, Sweden, Turkey, and United Kingdom. The ETSI version of this device is also authorized for use in EFTA member states: Iceland, Liechtenstein, Norway, and Switzerland.

### EU Countries Not Intended for Use

None

## EU Declaration of Conformity

- English:** This equipment is in compliance with the essential requirements and other relevant provisions of Directive 1999/5/EC, 2009/125/EC.
- French:** Cet équipement est conforme aux exigences essentielles et autres dispositions de la directive 1999/5/CE, 2009/125/CE.
- Czechian:** Toto zařízení je v souladu se základními požadavky a ostatními příslušnými ustanoveními směrnic 1999/5/ES, 2009/125/ES.
- Polish:** Urządzenie jest zgodne z ogólnymi wymaganiami oraz szczególnymi warunkami określonymi Dyrektywą UE 1999/5/EC, 2009/125/EC.
- Romanian:** Acest echipament este în conformitate cu cerințele esențiale și alte prevederi relevante ale Directivei 1999/5/CE, 2009/125/CE.
- Russian:** Это оборудование соответствует основным требованиям и положениям Директивы 1999/5/EC, 2009/125/EC.
- Magyar:** Ez a berendezés megfelel az alapvető követelményeknek és más vonatkozó irányelveknek (1999/5/EK, 2009/125/EC).
- Türkçe:** Bu cihaz 1999/5/EC, 2009/125/EC direktifleri zorunlu istekler ve diğer hükümlerle ile uyumludur.
- Ukrainian:** Обладнання відповідає вимогам і умовам директиви 1999/5/EC, 2009/125/EC.
- Slovakian:** Toto zariadenie spĺňa základné požiadavky a ďalšie príslušné ustanovenia smerníc 1999/5/ES, 2009/125/ES.
- German:** Dieses Gerät erfüllt die Voraussetzungen gemäß den Richtlinien 1999/5/EC, 2009/125/EC.
- Spanish:** El presente equipo cumple los requisitos esenciales de la Directiva 1999/5/EC, 2009/125/EC.
- Italian:** Questo apparecchio è conforme ai requisiti essenziali e alle altre disposizioni applicabili della Direttiva 1999/5/CE, 2009/125/CE.
- Dutch:** Dit apparaat voldoet aan de essentiële eisen en andere van toepassing zijnde bepalingen van richtlijn 1999/5/EC, 2009/125/EC.
- Portuguese:** Este equipamento cumpre os requisitos essenciais da Directiva 1999/5/EC, 2009/125/EC.
- Norwegian:** Dette utstyret er i samsvar med de viktigste kravene og andre relevante regler i Direktiv 1999/5/EC, 2009/125/EC.
- Swedish:** Denna utrustning är i överensstämmelse med de väsentliga kraven och övriga relevanta bestämmelser i direktiv 1999/5/EG, 2009/125/EG.
- Danish:** Dette udstyr er i overensstemmelse med de væsentligste krav og andre relevante forordninger i direktiv 1999/5/EC, 2009/125/EC.
- Finnish:** Tämä laite täyttää direktiivien 1999/5/EY, 2009/125/EY oleelliset vaatimukset ja muut asiaankuuluvat määräykset.

FOR USE IN

AT	BE	CY	CZ	DK	EE	FI	FR
DE	GR	HU	IE	IT	LV	LT	LU
MT	NL	PL	PT	SK	SI	ES	SE
GB	IS	LI	NO	CH	BG	RO	TR



---

## WEEE Directive & Product Disposal



At the end of its serviceable life, this product should not be treated as household or general waste. It should be handed over to the applicable collection point for the recycling of electrical and electronic equipment, or returned to the supplier for disposal.

## Declaration of Conformity

We, Edimax Technology Co., Ltd., declare under our sole responsibility, that the equipment described below complies with the requirements of the European R&TTE directive 1999/5/EC.

**Equipment:** N300 Universal Wi-Fi Extender  
**Model No.:** EW-7438RPn

The following European standards for essential requirements have been followed:

**Spectrum:** ETSI EN 300 328 V1.7.1 (2006-10)  
**EMC:** EN 301 489-1 V1.8.1 (2008-04);  
EN 301 489-17 V2.1.1 (2009-05)  
**EMF:** EN 50385:2002  
**Safety (LVD):** IEC 60950-1:2005 (2nd Edition);  
EN-60950-1:2006+A11:2009

Edimax Technology Co., Ltd.  
No. 3, Wu Chuan 3<sup>rd</sup> Road,  
Wu-Ku Industrial Park,  
New Taipei City, Taiwan



Date of Signature: November 15, 2011

Signature:

A handwritten signature in black ink, appearing to read 'Albert Chang'.

Printed Name: Albert Chang

Title: Director

Edimax Technology Co., Ltd.

## Notice According to GNU General Public License Version 2

This product includes software that is subject to the GNU General Public License version 2. The program is free software and distributed without any warranty of the author. We offer, valid for at least three years, to give you, for a charge no more than the costs of physically performing source distribution, a complete machine-readable copy of the corresponding source code.

Das Produkt beinhaltet Software, die den Bedingungen der GNU/GPL-Version 2 unterliegt. Das Programm ist eine sog. „Free Software“, der Autor stellt das Programm ohne irgendeine Gewährleistungen zur Verfügung. Wir bieten Ihnen für einen Zeitraum von drei Jahren an, eine vollständige maschinenlesbare Kopie des Quelltextes der Programme zur Verfügung zu stellen – zu nicht höheren Kosten als denen, die durch den physikalischen Kopiervorgang anfallen.

### GNU GENERAL PUBLIC LICENSE

Version 2, June 1991

Copyright (C) 1989, 1991 Free Software Foundation, Inc. 51 Franklin Street, Fifth Floor, Boston, MA 02110-1301, USA  
Everyone is permitted to copy and distribute verbatim copies of this license document, but changing it is not allowed.

#### Preamble

The licenses for most software are designed to take away your freedom to share and change it. By contrast, the GNU General Public License is intended to guarantee your freedom to share and change free software--to make sure the software is free for all its users. This General Public License applies to most of the Free Software Foundation's software and to any other program whose authors commit to using it. (Some other Free Software Foundation software is covered by the GNU Lesser General Public License instead.) You can apply it to your programs, too.

When we speak of free software, we are referring to freedom, not price. Our General Public Licenses are designed to make sure that you have the freedom to distribute copies of free software (and charge for this service if you wish), that you receive source code or can get it if you want it, that you can change the software or use pieces of it in new free programs; and that you know you can do these things.

To protect your rights, we need to make restrictions that forbid anyone to deny you these rights or to ask you to surrender the rights. These restrictions translate to certain responsibilities for you if you distribute copies of the software, or if you modify it.

For example, if you distribute copies of such a program, whether gratis or for a fee, you must give the recipients all the rights that you have. You must make sure that they, too, receive or can get the source code. And you must show them these terms so they know their rights.

We protect your rights with two steps: (1) copyright the software, and (2) offer you this license which gives you legal permission to copy, distribute and/or modify the software.

Also, for each author's protection and ours, we want to make certain that everyone understands that there is no warranty for this free software. If the software is modified by someone else and passed on, we want its recipients to know that what they have is not the original, so that any problems introduced by others will not reflect on the original authors' reputations.

Finally, any free program is threatened constantly by software patents. We wish to avoid the danger that redistributors of a free program will individually obtain patent licenses, in effect making the program proprietary. To prevent this, we have made it clear that any patent must be licensed for everyone's free use or not licensed at all.

The precise terms and conditions for copying, distribution and modification follow.

#### TERMS AND CONDITIONS FOR COPYING, DISTRIBUTION AND MODIFICATION

0. This License applies to any program or other work which contains a notice placed by the copyright holder saying it may be distributed under the terms of this General Public License. The "Program", below, refers to any such program or work, and a "work based on the Program" means either the Program or any derivative work under copyright law: that is to say, a work containing the Program or a portion of it, either verbatim or with modifications and/or translated into another language. (Hereinafter, translation is included without limitation in the term "modification".) Each licensee is addressed as "you".

Activities other than copying, distribution and modification are not covered by this License; they are outside its scope. The act of running the Program is not restricted, and the output from the Program is covered only if its contents constitute a work based on the Program (independent of having been made by running the Program). Whether that is true depends on what the Program does.

1. You may copy and distribute verbatim copies of the Program's source code as you receive it, in any medium, provided that you conspicuously and appropriately publish on each copy an appropriate copyright notice and disclaimer of warranty; keep



intact all the notices that refer to this License and to the absence of any warranty; and give any other recipients of the Program a copy of this License along with the Program.

You may charge a fee for the physical act of transferring a copy, and you may at your option offer warranty protection in exchange for a fee.

2. You may modify your copy or copies of the Program or any portion of it, thus forming a work based on the Program, and copy and distribute such modifications or work under the terms of Section 1 above, provided that you also meet all of these conditions:

- a) You must cause the modified files to carry prominent notices stating that you changed the files and the date of any change.
- b) You must cause any work that you distribute or publish, that in whole or in part contains or is derived from the Program or any part thereof, to be licensed as a whole at no charge to all third parties under the terms of this License.
- c) If the modified program normally reads commands interactively when run, you must cause it, when started running for such interactive use in the most ordinary way, to print or display an announcement including an appropriate copyright notice and a notice that there is no warranty (or else, saying that you provide a warranty) and that users may redistribute the program under these conditions, and telling the user how to view a copy of this License. (Exception: if the Program itself is interactive but does not normally print such an announcement, your work based on the Program is not required to print an announcement.)

These requirements apply to the modified work as a whole. If identifiable sections of that work are not derived from the Program, and can be reasonably considered independent and separate works in themselves, then this License, and its terms, do not apply to those sections when you distribute them as separate works. But when you distribute the same sections as part of a whole which is a work based on the Program, the distribution of the whole must be on the terms of this License, whose permissions for other licensees extend to the entire whole, and thus to each and every part regardless of who wrote it.

Thus, it is not the intent of this section to claim rights or contest your rights to work written entirely by you; rather, the intent is to exercise the right to control the distribution of derivative or collective works based on the Program.

In addition, mere aggregation of another work not based on the Program with the Program (or with a work based on the Program) on a volume of a storage or distribution medium does not bring the other work under the scope of this License.

3. You may copy and distribute the Program (or a work based on it, under Section 2) in object code or executable form under the terms of Sections 1 and 2 above provided that you also do one of the following:

- a) Accompany it with the complete corresponding machine-readable source code, which must be distributed under the terms of Sections 1 and 2 above on a medium customarily used for software interchange; or,
- b) Accompany it with a written offer, valid for at least three years, to give any third party, for a charge no more than your cost of physically performing source distribution, a complete machine-readable copy of the corresponding source code, to be distributed under the terms of Sections 1 and 2 above on a medium customarily used for software interchange; or,
- c) Accompany it with the information you received as to the offer to distribute corresponding source code. (This alternative is allowed only for noncommercial distribution and only if you received the program in object code or executable form with such an offer, in accord with Subsection b above.)

The source code for a work means the preferred form of the work for making modifications to it. For an executable work, complete source code means all the source code for all modules it contains, plus any associated interface definition files, plus the scripts used to control compilation and installation of the executable. However, as a special exception, the source code distributed need not include anything that is normally distributed (in either source or binary form) with the major components (compiler, kernel, and so on) of the operating system on which the executable runs, unless that component itself accompanies the executable.

If distribution of executable or object code is made by offering access to copy from a designated place, then offering equivalent access to copy the source code from the same place counts as distribution of the source code, even though third parties are not compelled to copy the source along with the object code.

4. You may not copy, modify, sublicense, or distribute the Program except as expressly provided under this License. Any attempt otherwise to copy, modify, sublicense or distribute the Program is void, and will automatically terminate your rights under this License. However, parties who have received copies, or rights, from you under this License will not have their licenses terminated so long as such parties remain in full compliance.

5. You are not required to accept this License, since you have not signed it. However, nothing else grants you permission to modify or distribute the Program or its derivative works. These actions are prohibited by law if you do not accept this License. Therefore, by modifying or distributing the Program (or any work based on the Program), you indicate your acceptance of this License to do so, and all its terms and conditions for copying, distributing or modifying the Program or works based on it.

6. Each time you redistribute the Program (or any work based on the Program), the recipient automatically receives a license from the original licensor to copy, distribute or modify the Program subject to these terms and conditions. You may not impose any further restrictions on the recipients' exercise of the rights granted herein. You are not responsible for enforcing compliance by third parties to this License.

7. If, as a consequence of a court judgment or allegation of patent infringement or for any other reason (not limited to patent issues), conditions are imposed on you (whether by court order, agreement or otherwise) that contradict the conditions of this License, they do not excuse you from the conditions of this License. If you cannot distribute so as to satisfy simultaneously your obligations under this License and any other pertinent obligations, then as a consequence you may not distribute the Program at all. For example, if a patent license would not permit royalty-free redistribution of the Program by all those who receive copies directly or indirectly through you, then the only way you could satisfy both it and this License would be to refrain entirely from distribution of the Program.

If any portion of this section is held invalid or unenforceable under any particular circumstance, the balance of the section is intended to apply and the section as a whole is intended to apply in other circumstances.

It is not the purpose of this section to induce you to infringe any patents or other property right claims or to contest validity of any such claims; this section has the sole purpose of protecting the integrity of the free software distribution system, which is implemented by public license practices. Many people have made generous contributions to the wide range of software distributed through that system in reliance on consistent application of that system; it is up to the author/donor to decide if he or she is willing to distribute software through any other system and a licensee cannot impose that choice.

This section is intended to make thoroughly clear what is believed to be a consequence of the rest of this License.

8. If the distribution and/or use of the Program is restricted in certain countries either by patents or by copyrighted interfaces, the original copyright holder who places the Program under this License may add an explicit geographical distribution limitation excluding those countries, so that distribution is permitted only in or among countries not thus excluded. In such case, this License incorporates the limitation as if written in the body of this License.

9. The Free Software Foundation may publish revised and/or new versions of the General Public License from time to time. Such new versions will be similar in spirit to the present version, but may differ in detail to address new problems or concerns.

Each version is given a distinguishing version number. If the Program specifies a version number of this License which applies to it and "any later version", you have the option of following the terms and conditions either of that version or of any later version published by the Free Software Foundation. If the Program does not specify a version number of this License, you may choose any version ever published by the Free Software Foundation.

10. If you wish to incorporate parts of the Program into other free programs whose distribution conditions are different, write to the author to ask for permission. For software which is copyrighted by the Free Software Foundation, write to the Free Software Foundation; we sometimes make exceptions for this. Our decision will be guided by the two goals of preserving the free status of all derivatives of our free software and of promoting the sharing and reuse of software generally.

#### **NO WARRANTY**

11. BECAUSE THE PROGRAM IS LICENSED FREE OF CHARGE, THERE IS NO WARRANTY FOR THE PROGRAM, TO THE EXTENT PERMITTED BY APPLICABLE LAW. EXCEPT WHEN OTHERWISE STATED IN WRITING THE COPYRIGHT HOLDERS AND/OR OTHER PARTIES PROVIDE THE PROGRAM "AS IS" WITHOUT WARRANTY OF ANY KIND, EITHER EXPRESSED OR IMPLIED, INCLUDING, BUT NOT LIMITED TO, THE IMPLIED WARRANTIES OF MERCHANTABILITY AND FITNESS FOR A PARTICULAR PURPOSE. THE ENTIRE RISK AS TO THE QUALITY AND PERFORMANCE OF THE PROGRAM IS WITH YOU. SHOULD THE PROGRAM PROVE DEFECTIVE, YOU ASSUME THE COST OF ALL NECESSARY SERVICING, REPAIR OR CORRECTION.

12. IN NO EVENT UNLESS REQUIRED BY APPLICABLE LAW OR AGREED TO IN WRITING WILL ANY COPYRIGHT HOLDER, OR ANY OTHER PARTY WHO MAY MODIFY AND/OR REDISTRIBUTE THE PROGRAM AS PERMITTED ABOVE, BE LIABLE TO YOU FOR DAMAGES, INCLUDING ANY GENERAL, SPECIAL, INCIDENTAL OR CONSEQUENTIAL DAMAGES ARISING OUT OF THE USE OR INABILITY TO USE THE PROGRAM (INCLUDING BUT NOT LIMITED TO LOSS OF DATA OR DATA BEING RENDERED INACCURATE OR LOSSES SUSTAINED BY YOU OR THIRD PARTIES OR A FAILURE OF THE PROGRAM TO OPERATE WITH ANY OTHER PROGRAMS), EVEN IF SUCH HOLDER OR OTHER PARTY HAS BEEN ADVISED OF THE POSSIBILITY OF SUCH DAMAGES.



**EDIMAX**  
NETWORKING PEOPLE TOGETHER

**Edimax Technology Co., Ltd**

6F., No.3, Wu-Chuan 3rd Road, Wu-Gu,  
New Taipei City, Taiwan

**Edimax Technology Europe B.V.**

Nijverheidsweg 25 5683 CJ Best  
The Netherlands

**Edimax Computer Company**

3350 Scott Blvd., Bldg.15 Santa Clara,  
CA 95054, USA