

# **Rittal – The System.**

Faster – better – worldwide.



**Geräteboden, ausziehbar**  
**Component shelf, pull-out**  
**Tablette, télescopique**  
**Legbord, uittrekbaar**  
**Hyllplan, utdragbart**  
**Ripiano porta-apparecchi, estraibile**  
**Bandeja para aparatos, extraíble**  
**引き出し式ユニットテーブル**

DK 5501.675

DK 5501.685

DK 5501.715

DK 5501.725

**Montage- und Bedienungsanleitung**  
**Assembly and operating instructions**  
**Notice d'emploi et de montage**  
**Montage- en bedieningshandleiding**  
**Montage- och bruksanvisning**  
**Istruzioni di montaggio**  
**Instrucciones de montaje**  
**取扱説明書**

ENCLOSURES

POWER DISTRIBUTION



CLIMATE CONTROL

IT INFRASTRUCTURE

SOFTWARE & SERVICES

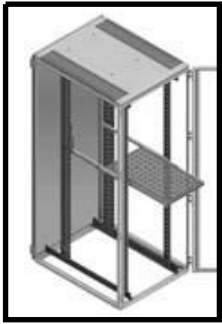

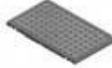

	X mm	D mm	 F [N]	
<b>Best.-Nr. DK</b> <b>Model No. DK</b> <b>Référence DK</b>	400 - 600	500	↓ 500	<b>5501.675</b>
	600 - 900	700	↓ 500	<b>5501.685</b>
	400 - 600	500	↓ 1000	<b>5501.715</b>
	600 - 900	700	↓ 1000	<b>5501.725</b>
				1 x
				2 x

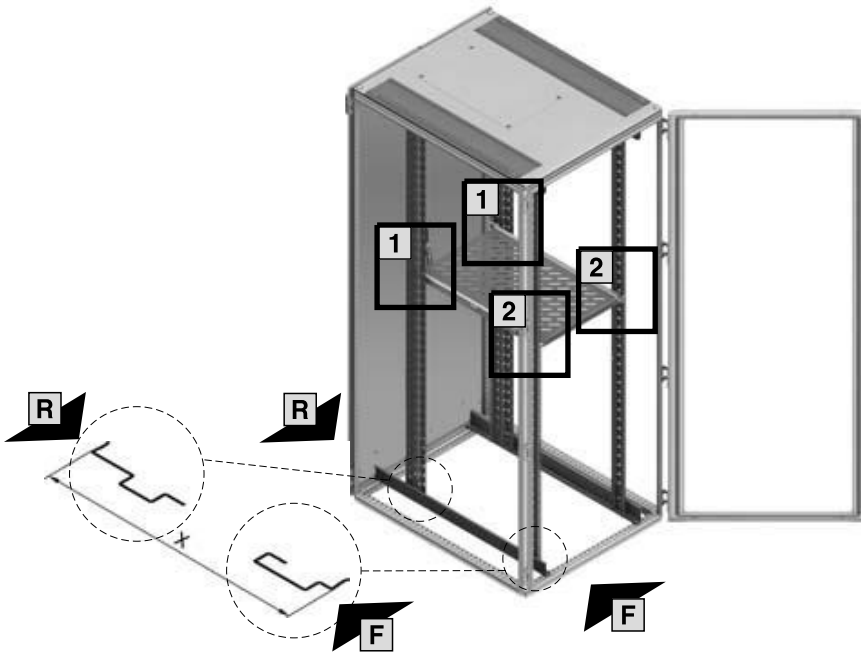

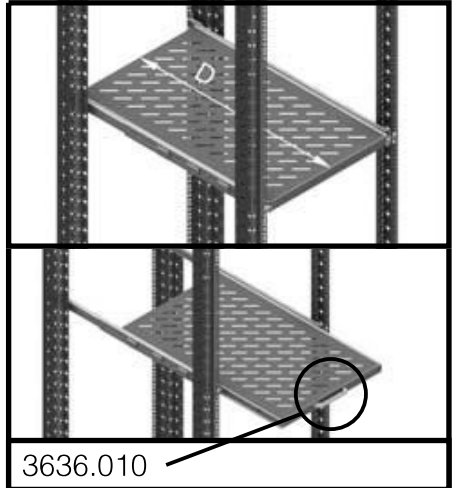
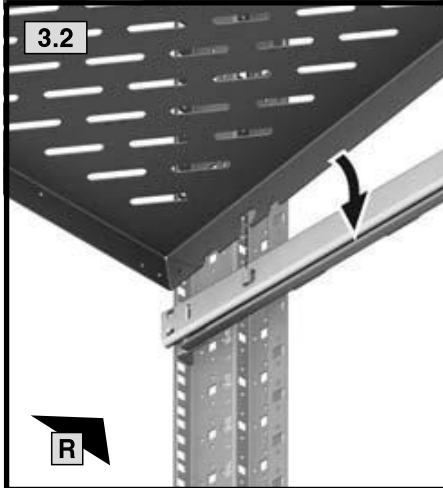
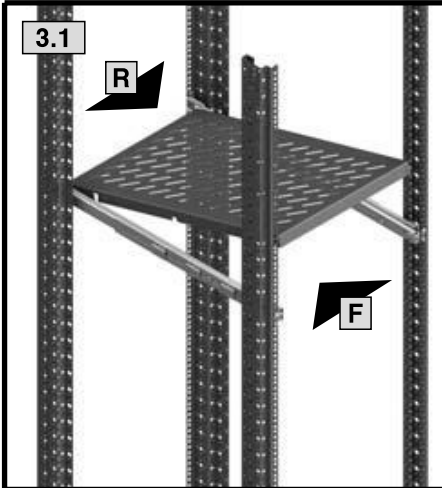
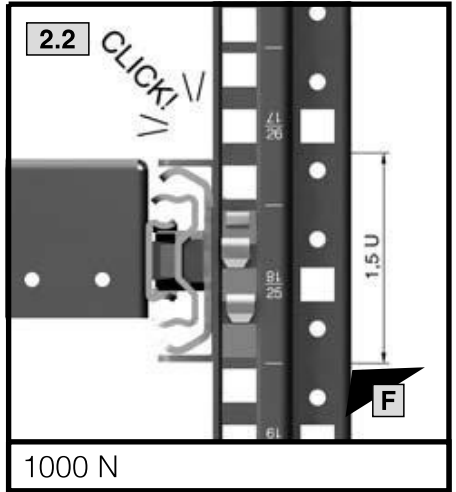
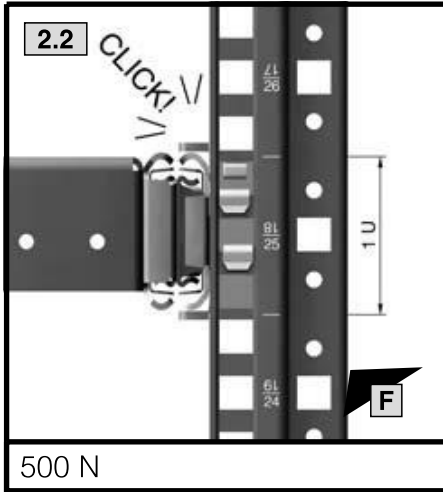
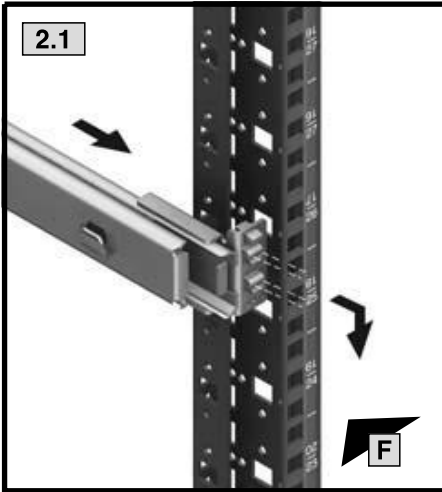
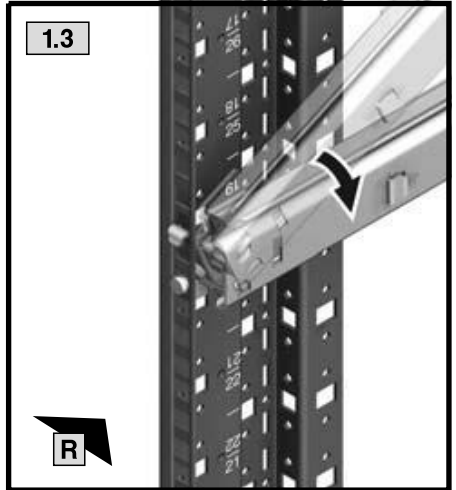
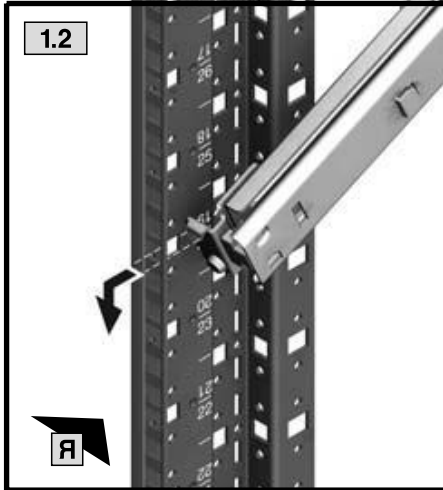
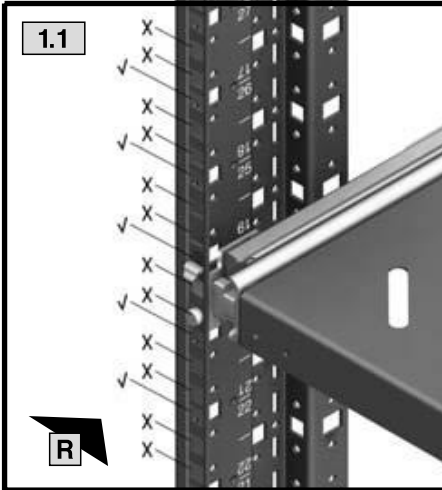

# **Rittal – The System.**

---

**Faster – better – worldwide.**

- Enclosures
- Power distribution
- Climate control
- IT infrastructure
- Software & services

04.2012/A4638100IT73

RITTAL GmbH & Co. KG  
Postfach 1662 · D-35726 Herborn  
Phone + 49(0)2772 505-0 · Fax + 49(0)2772 505-2319  
E-Mail: [info@rittal.de](mailto:info@rittal.de) · [www.rittal.de](http://www.rittal.de)

ENCLOSURES

POWER DISTRIBUTION

CLIMATE CONTROL

IT INFRASTRUCTURE

SOFTWARE & SERVICES

