

## Thule ClipOn High 9106

# ➤ Recommendations



**910601**

4DF/12.20140130  
501-7298-07

**EN List of recommendations** If you do not find your particular car model in the recommendation list, please see Thule Guide at [www.thule.com](http://www.thule.com) or contact your dealer.

**DE Empfehlungsliste** Wenn Sie Ihr eigenes Auto nicht in der empfohlenen Tabelle finden sollten, so schauen Sie bitte in den Thule-Dachträger-Kaufhilfe in [www.thule.com](http://www.thule.com) oder wenden Sie sich bitte an Ihren Thule-Händler.

**FR Liste de modèle de voitures** Vérifier la liste des modèles de voitures recommandés, veuillez consulter notre guide d'achat sur [www.thule.com](http://www.thule.com) ou contacter votre revendeur.

**NL Aanbevelingen** Indien u uw auto niet in de lijst terugvindt, gelieve de Thule koopgids op [www.thule.com](http://www.thule.com) of uw Thule-dealer te raadplegen.

**IT Lista delle raccomandazioni** Se il proprio modello di automobile non è presente nella lista delle raccomandazioni, consultare la Thule Guide all'indirizzo [www.thule.com](http://www.thule.com) o contattare il proprio rivenditore.

**ES Lista de recomendaciones** Si no encuentra su automóvil en la lista, vea la guía del comprador en [www.thule.com](http://www.thule.com) o póngase en contacto con el establecimiento de venta local.

**PT Lista de recomendações** Caso não encontre seu modelo específico de carro na lista de recomendação, favor verificar o Guia de Bagageiros de Teto Thule em [www.thule.com](http://www.thule.com) ou contate seu revendedor.

**SV Rekommendationslista** Hittar du inte din bil i rekommendationslistan, se köphjälpen på [www.thule.com](http://www.thule.com) eller kontakta din återförsäljare.

**DK Liste med anbefalinger.** Der henvises til forhandleren eller Thule Guide på adressen [www.thule.com](http://www.thule.com) hvis du ikke kan finde netop din bilmodel på listen.

**NE Anbefalingsliste** Hvis du ikke finner din bestemte bilmodell i anbefalingslisten, kan du se Thule-brosjyren på [www.thule.com](http://www.thule.com) eller kontakte forhandleren.

**FI Suosituslistaa** Jos et löydä automalliasi suositustaulukosta, katso Thulen Osto-opas kotisivuillamme [www.thule.com](http://www.thule.com) tai ota yhteys jälleenmyyjääsi.

**ET Soovituste loend** Kui Te ei leia oma automodelit soovituste loendist, vaadake Thule katuseraamide juhti aadressil [www.thule.com](http://www.thule.com) või võtke ühendust müügiagediga

**LV Ieteikumu saraksts** Ja jūsu automašīnas modelis nav norādīts ieteikumu sarakstā, lūdzu, skatiet Thule r okasgrāmatu vietnē [www.thule.com](http://www.thule.com) vai sazinieties ar savu izplatītāju.

**LT Rekomendacijų sąrašas** Jei rekomendacijų sąraše nerandate konkretaus savo automobilio modelio, r. „Thule“ vadovą adresu [www.thule.com](http://www.thule.com) arba kreipkitės į savo atstovą.

**PL Lista zalecanych aut** Jeżeli na liście zalecanych aut nie możesz znaleźć swego modelu, zobacz przewodnik Thule Guide na stronie [www.thule.com](http://www.thule.com) lub skontaktuj się z dealerem.

**RU Список рекомендаций** Если не удастся найти конкретную модель автомобиля в рекомендационном списке, см. руководство Thule на веб-сайте [www.thule.com](http://www.thule.com) или обратитесь к дилеру.

**UK Список рекомендацій** Якщо у списку рекомендацій немає вашої моделі автомобіля, дивіться інструкції Thule на веб-сайті [www.thule.com](http://www.thule.com) або зверніться до вашого дилера.

**BG Списък с препоръки** Ако не намерите Вашия конкретен модел автомобил в списъка с препоръки, вижте Ръководството на Thule на [www.thule.com](http://www.thule.com) или се свържете с Вашия дилър.

**CS Seznam doporučených vozů** Pokud nenaleznete určitý model svého vozidla v seznamu doporučených vozů, podívejte se prosím na průvodce produkty Thule na web [www.thule.com](http://www.thule.com) nebo se obraťte na svého prodejce.

**SK Zoznam odporúčaných vozidiel** Ak nenájdete určitý model svojho vozidla v zoznamu odporúčaných vozidiel, pozrite si, prosím, sprievodcu produktmi Thule na webovej stránke [www.thule.com](http://www.thule.com) alebo sa obráťte na svojho predajcu.

**SL Seznam ustreznih modelov in tipov vozil** V primeru, da ne najdete svojega vozila, pojdite na spletno stran [www.thule.com](http://www.thule.com) - Thule Guide ali pa se posvetujte s prodajalcem.

**HR/BiH Popis opreme s preporukom** Ako u opisu opreme s preporukom prema vrsti automobila ne možete pronaci svoj model automobila, molimo pogledajte Vodič tvrtke Thule na web stranici [www.thule.com](http://www.thule.com) ili kontaktirajte svog distributera.

**RO Lista de recomandări** Dacă nu găsiți modelul mașinii d-voastră în lista de recomandări, vă rugăm să consultați Ghidul Thule la [www.thule.com](http://www.thule.com) sau să contactați distribuitorul.

**HU Ajánlások jegyzéke** Amennyiben az Ajánlások jegyzékében nem találja az adott gépkocsimodellt, kérjük látogasson el a Thule Guide weblapra a [www.thule.com](http://www.thule.com) webcímen, vagy lépjen kapcsolatba a helyi értékesítővel.

**EL Λίστα συστάσεων** Εάν δεν βρίσκετε το συγκεκριμένο μοντέλο αυτοκινήτου στη λίστα συστάσεων, ανατρέξτε στον Οδηγό της Thule στη διεύθυνση [www.thule.com](http://www.thule.com) ή επικοινωνήστε με τον κοντινό σας αντιπρόσωπο.

**TR Öneri Listesi** Aradığınız araç modelini öneri listesinde bulamazsanız, lütfen [www.thule.com](http://www.thule.com) internet sitesinden Thule Kılavuzuna bakın veya bayiinize danışın.

**AR قائمة بالتوصيات** إذا لم تعثر على طراز سيارتك في قائمة التوصيات، فيرجى الاطلاع على *Thule Guide* (دليل *Thule*) على الموقع الإلكتروني [www.thule.com](http://www.thule.com)

**HE רשימת המלצות** אם לא תמצא את דגם המכונית שלך ברשימת המומלצים, עיין ב'מדריך של *Thule*' בכותבת [www.thule.com](http://www.thule.com) או צור קשר עם הספק שלך.



**ZH 推奨リスト** 推奨リストにご希望の車種が含まれていない場合は、[www.thule.com](http://www.thule.com) の *Thule* ガイドをご参照いただくか、お近くの販売店にお問い合わせください。



**JA 推奨事項** のリスト推奨リストにお使いの車両モデルが見つからない場合は、スーリーガイド([www.thule.com](http://www.thule.com))でご確認いただくか、販売店にお問い合わせください。



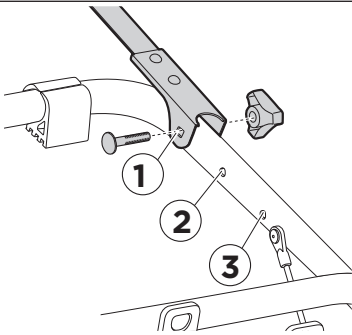

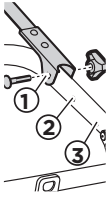
**KO 권장 목록** 권장 목록에서 특정 차량 모델을 찾을 수 없으면 [www.thule.com](http://www.thule.com) 에서 *Thule* 설명서를 참조하거나 가까운 대리점에 문의하십시오.

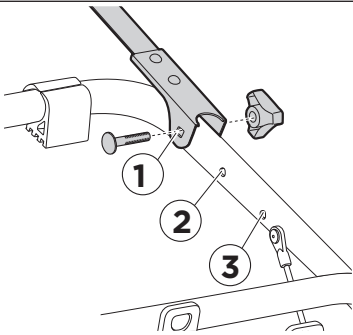

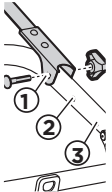
**TH รายการคำแนะนำ** ถ้าคุณไม่พบรุ่นรถที่ต้องการในรายการคำแนะนำ โปรดอ่านคู่มือของ *Thule* ใดที่ [www.thule.com](http://www.thule.com) หรือติดต่อตัวแทนจำหน่ายของคุณ.

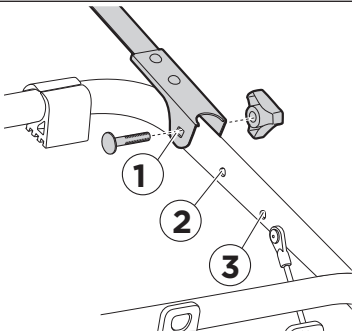
AUDI A6, 5-dr Estate, 94-97	TÜV	-	3
AUDI A6, 5-dr Estate, 05-11	TÜV	9115	2
AUDI A6 Allroad, 5-dr Estate, 06-12	TÜV	9115	2
BMW 5-serie, 5-dr Estate, 97-00	TÜV	-	3
CHEVROLET Nubira, 5-dr Estate, 04-	TÜV	-	3
CHEVROLET Trans Sport, 5-dr MPV, 97-	TÜV	9111	2
CHEVROLET Tacuma, 5-dr Estate, 04-	-	-	2
CHEVROLET Uplander, 5-dr MPV, 05-09	TÜV	9111	2
CHRYSLER Grand Voyager, 5-dr MPV, 96-00	TÜV	9111	2
CHRYSLER Grand Voyager, 5-dr MPV, 01-07	TÜV	9111	1
CHRYSLER Voyager, 5-dr MPV, 88-95	TÜV	-	1
CHRYSLER Voyager, 5-dr MPV, 96-00	TÜV	9111	2
CHRYSLER Voyager, 5-dr MPV, 01-04	TÜV	9111	1
CHRYSLER Voyager, 5-dr MPV, 05-07	TÜV	9111	1
CITROËN C3 Picasso, 5-dr MPV, 09-	-	-	3
CITROËN Evasion, 5-dr MPV, 94-02	TÜV	9111	2
CITROËN Xsara Picasso, 5-dr MPV, 00-03	TÜV	9111	1
CITROËN Xsara Picasso, 5-dr MPV, 04-	TÜV	9111	1
DACIA Duster, 5-dr SUV, 10-	-	9115	2
DACIA Sandero, 5-dr Hatchback, 08-12	-	-	3
DACIA Sandero StepWay, 5-dr SUV, 09-12	-	-	3
DAEWOO Tacuma, 5-dr Estate, 00-	-	-	2
DAIHATSU Charade, 3/5-dr Hatchback, 07-	-	-	3
DAIHATSU Cuore II, 3/5-dr Hatchback, 06-	-	-	3
DAIHATSU Sirion, 5-dr Hatchback, 98-04	TÜV	-	2
DAIHATSU Trevis, 5-dr Hatchback, 06-	TÜV	-	3
DODGE Grand Caravan, 5-dr MPV, 96-00	TÜV	9111	2
DODGE Grand Caravan, 5-dr MPV, 01-04	TÜV	9111	1
DODGE Grand Caravan, 5-dr MPV, 05-	TÜV	9111	1

			
DODGE Caravan, 5-dr MPV, 88-95	TÜV	-	1
DODGE Caravan, 5-dr MPV, 96-00	TÜV	9111	2
DODGE Caravan, 5-dr MPV, 01-04	TÜV	9111	1
DODGE Caravan, 5-dr MPV, 05-	TÜV	9111	1
FIAT 500, 3-dr Hatchback, 07-	TÜV	-	3
FIAT Croma, 5-dr Estate, 05-07	TÜV	-	1
FIAT Idea, 5-dr MPV, 03-	-	-	2
FIAT Panda, 5-dr Hatchback, 03-11	-	9110	3
FIAT Panda Cross, 5-dr Hatchback, 03-11	-	9110	3
FIAT Stilo 1.6, 3/5-dr Hatchback, 02-	-	-	2
FIAT Ulysse, 5-dr MPV, 94-02	TÜV	9111	2
FORD B-Max, 5-dr MPV, 12-	TÜV	-	2
FORD C-Max II, 5-dr MPV, 10-	-	-	2
FORD Escort, 5-dr Estate, 91-99	TÜV	-	3
FORD Explorer, 5-dr SUV, 91-93	TÜV	-	2
FORD Fiesta, 3/5-dr Hatchback, 90-95	TÜV	-	2
FORD Fiesta, 3/5-dr Hatchback, 96-01	TÜV	-	2
FORD Focus, 5-dr Estate, 98-04	TÜV	-	3
FORD Focus II, 5-dr Estate, 04-07	-	-	3
FORD Focus II, 5-dr Estate, 08-	-	-	3
FORD Fusion, 5-dr Hatchback, 06-	-	-	3
FORD Galaxy, 5-dr MPV, 95-00	TÜV	9111	3
FORD Galaxy, 5-dr MPV, 01-05	TÜV	9111	3
FORD Grand C-Max, 5-dr MPV, 10-	-	9111	2
FORD Maverick, 5-dr SUV, 01-07	TÜV	-	3
FORD Mondeo, 5-dr Estate, 93-00	TÜV	-	3
FORD Mondeo, 5-dr Estate, 01-03	-	-	3
FORD Windstar, 5-dr MPV, 95-97	TÜV	9111	1
HYUNDAI Atos, 3/5-dr Hatchback, 98-03	-	-	3

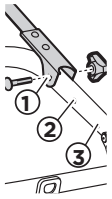
			
HYUNDAI Atos Prime, 3/5-dr Hatchback, 04-	TÜV	-	3
HYUNDAI Matrix, 5-dr MPV, 01-	TÜV	-	1
HYUNDAI Santa Fé, 5-dr SUV, 06-09	TÜV	-	2
HYUNDAI Terracan, 5-dr SUV, 01-03	TÜV	-	2
HYUNDAI Tucson, 5-dr SUV, 04-	TÜV	-	3
JEEP Cherokee, 5-dr SUV, 98-00	TÜV	-	3
JEEP Commander, 5-dr SUV, 06-	TÜV	-	3
JEEP Grand Cherokee, 5-dr SUV, 99-04	TÜV	-	3
JEEP Grand Cherokee, 5-dr SUV, 05-	TÜV	-	2
KIA Carens, 5-dr MPV, 02-05	TÜV	-	3
KIA Carens, 5-dr MPV, 06-12	TÜV	9115	3
KIA Carneval I, 5-dr MPV, 98-01	TÜV	9111	1
KIA Carneval II, 5-dr MPV, 02-05	TÜV	9111	1
KIA Carneval III, 5-dr MPV, 06-	TÜV	9111	2
KIA Sorento, 5-dr SUV, 02-08	TÜV	-	2
KIA Sportage, 5-dr SUV, 94-03	TÜV	-	3
KIA Sportage, 5-dr SUV, 04-07	TÜV	9115	1
KIA Sportage, 5-dr SUV, 08-09	TÜV	9115	1
KIA Sportage, 5-dr SUV, 10-	TÜV	-	2
KIA Venga, 5-dr Hatchback, 10-	TÜV	-	3
LANCIA Zeta, 5-dr MPV, 94-02	TÜV	9111	2
LEXUS RX 300, 5-dr SUV, 98-03	TÜV	-	2
MAZDA 2, 5-dr Hatchback, 03-05	TÜV	-	2
MAZDA 5, 5-dr MPV, 11-	TÜV	-	2
MAZDA 6, 5-dr Estate, 02-07	TÜV	-	3
MAZDA Demio, 5-dr MPV, 96-00	TÜV	-	3
MAZDA Demio, 5-dr MPV, 01-02	TÜV	-	3
MAZDA MPV, 5-dr MPV, 00-	TÜV	9111	1
MAZDA Premacy, 5-dr SUV, 99-01	-	-	1

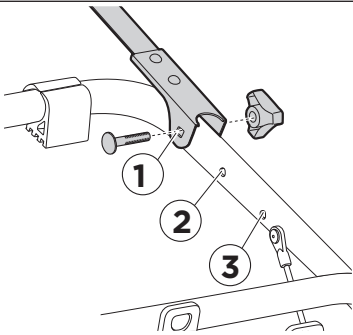

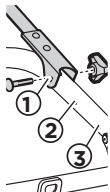

	 		
MAZDA Premacy, 5-dr SUV, 02-	-	-	1
MAZDA Tribute, 5-dr SUV, 00-06	TÜV	-	3
MERCEDES A-klasse (W169), 3/5-dr Hatchback, 04-	TÜV	-	3
MERCEDES B-klasse (W245), 5-dr Hatchback, 05-11	TÜV	-	3
MERCEDES M-Klasse (W164), 5-dr SUV, 05-11	TÜV	-	2
MERCEDES R-Klasse (W251), 5-dr Estate, 05-	TÜV	-	3
mitsubishi Colt, 5-dr Hatchback, 04-10	-	-	3
mitsubishi Colt, 5-dr Hatchback, 11-	-	-	3
mitsubishi Galant, 5-dr Estate, 97-05	TÜV	-	3
mitsubishi Space Star, 5-dr MPV, 98-01	-	-	2
mitsubishi Space Star, 5-dr MPV, 02-05	-	-	2
mitsubishi Space Wagon, 3-dr MPV, 99-03	TÜV	-	1
NISSAN Almera Tino, 5-dr MPV, 99-01	-	-	3
NISSAN Almera Tino, 5-dr MPV, 02-06	-	-	3
NISSAN Micra (K13), 3/5-dr Hatchback, 10-13	TÜV	-	3
NISSAN Pathfinder, 5-dr SUV, 05-	TÜV	9111	3
NISSAN Primera (W11), 5-dr Estate, 97-01	TÜV	-	3
NISSAN Primera (W12), 5-dr Estate, 02-07	TÜV	-	1
NISSAN X-Trail, 5-dr SUV, 01-03	-	-	2
NISSAN X-Trail, 5-dr SUV, 04-06	-	-	2
OPEL Agila, 5-dr MPV, 00-07	TÜV	-	3
OPEL Astra, 3/5-dr Hatchback, 92-97	TÜV	-	3
OPEL Astra, 5-dr Estate, 92-97	TÜV	-	3
OPEL Astra, 5-dr Estate, 02-09	TÜV	-	3
OPEL Meriva, 5-dr MPV, 03-06	-	-	2
OPEL Meriva, 5-dr MPV, 10-	TÜV	-	3
OPEL Omega, 5-dr Estate, 94-03	TÜV	-	3
OPEL Vectra, 5-dr Estate, 96-02	-	-	3
OPEL Vectra, 5-dr Estate, 03-05	TÜV	9115	3

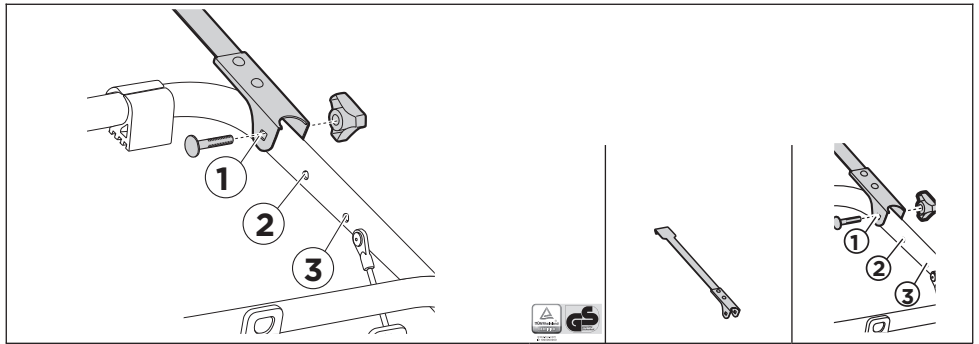
			
OPEL Vectra, 5-dr Estate, 06-08	TÜV	9115	3
OPEL Zafira, 5-dr MPV, 98-04	-	-	2
OPEL Zafira, 5-dr MPV, 05-11	-	-	1
OPEL Zafira Family, 5-dr MPV, 11-	-	-	1
OPEL Zafira Tourer, 5-dr MPV, 11-	TÜV	-	2
PEUGEOT 207 SW, 5-dr Estate, 07-	TÜV	9115	2
PEUGEOT 307 SW, 5-dr Estate, 02-04	TÜV	-	3
PEUGEOT 307 SW, 5-dr Estate, 05-08	TÜV	-	3
PEUGEOT 308 SW, 5-dr Estate, 08-	TÜV	-	3
PEUGEOT 806, 5-dr MPV, 94-02	TÜV	9111	2
PEUGEOT 5008, 5-dr MPV, 09-	-	-	3
RENAULT Mégane, 5-dr Estate, 99-03	TÜV	-	3
RENAULT Mégane III, 5-dr Hatchback, 09-	TÜV	9115	3
RENAULT Scénic II, 5-dr MPV, 03-08	-	-	2
RENAULT Scénic III, 5-dr MPV, 09-	-	-	2
RENAULT Scénic X Mod, 5-dr MPV, 09-	-	-	2
RENAULT Grand Scénic II, 5-dr MPV, 04-08	-	9115	2
RENAULT Grand Scénic III, 5-dr MPV, 09-	-	-	2
SEAT Alhambra, 5-dr MPV, 96-00	TÜV	9111	3
SEAT Alhambra, 5-dr MPV, 01-09	TÜV	9111	3
SEAT Alhambra (Mk II), 5-dr MPV, 10-	TÜV	-	2
SEAT Altea, 5-dr Hatchback, 04-09	TÜV	-	3
SEAT Altea XL, 5-dr Estate, 06-	TÜV	-	3
SEAT Altea XL Freetrack, 5-dr Estate, 06-	TÜV	-	3
SEAT Ibiza ST, 5-dr Estate, 10-	TÜV	-	2
SKODA Fabia, 5-dr Estate, 01-07	TÜV	-	3
SKODA Fabia, 5-dr Hatchback, 07-	TÜV	-	3
SKODA Fabia, 5-dr Estate, 08-	-	9115	2
SKODA Felicia, 5-dr Estate, 94-01	TÜV	-	3



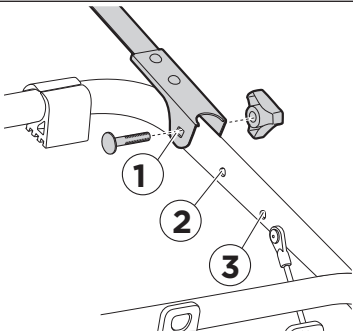

SKODA Felicia, 5-dr Hatchback, 95-01	TÜV	-	3
SKODA Rapid Spaceback, 5-dr Hatchback, 14-	TÜV	-	2
SKODA Roomster, 5-dr MPV, 06-	-	-	2
SKODA Roomster Scout, 5-dr MPV, 09-	-	-	2
SKODA Superb, 5-dr Estate, 09-	TÜV	9115	2
SKODA Superb Alldrive, 5-dr Estate, 12-	TÜV	9115	2
SSANGYONG Musso, 5-dr SUV, 95-05	TÜV	-	2
SUBARU Forester, 5-dr SUV, 02-05	TÜV	-	3
SUBARU Forester, 5-dr SUV, 06-07	TÜV	-	3
SUBARU Forester, 5-dr SUV, 08-12	TÜV	-	3
SUBARU Impreza, 5-dr Estate, 93-00	TÜV	-	2
SUBARU Impreza, 5-dr Estate, 01-03	TÜV	-	3
SUBARU Legacy II, 5-dr Estate, 94-02	TÜV	-	1
SUBARU Legacy IV, 5-dr Estate, 09-	TÜV	-	2
SUBARU Outback, 5-dr Estate, 94-02	TÜV	-	3
SUBARU Outback, 5-dr Estate, 10-	TÜV	-	2
SUZUKI Liana, 5-dr Hatchback, 01-03	TÜV	-	3
SUZUKI Liana, 5-dr Hatchback, 04-07	TÜV	-	3
SUZUKI Wagon R+, 5-dr MPV, 99-03	TÜV	-	3
TOYOTA Avensis, 5-dr Estate, 98-02	TÜV	-	3
TOYOTA Avensis Verso, 5-dr MPV, 01-03	TÜV	-	3
TOYOTA Auris, 3/5-dr Hatchback, 06-12	TÜV	-	3
TOYOTA Auris, 5-dr Estate, 13-	-	-	3
TOYOTA Corolla, 5-dr Estate, 88-92	TÜV	-	3
TOYOTA Corolla, 5-dr Estate, 93-97	TÜV	-	2
TOYOTA Corolla, 5-dr Estate, 98-01	-	-	3
TOYOTA Corolla, 5-dr Estate, 02-04	TÜV	-	3
TOYOTA Corolla, 5-dr Estate, 04-08	-	-	3
TOYOTA Corolla, 3/5-dr Hatchback, 05-	TÜV	-	3

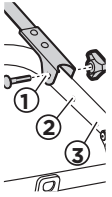
	 		
TOYOTA Corolla Verso, 5-dr MPV, 02-03	-	-	3
TOYOTA Corolla Verso, 5-dr MPV, 04-08	-	-	3
TOYOTA Picnic, 5-dr MPV, 97-00	TÜV	-	3
TOYOTA Picnic, 5-dr MPV, 01-	TÜV	-	3
TOYOTA Previa, 5-dr MPV, 90-99	-	9111	1
VAUXHALL Agila, 5-dr MPV, 00-07	TÜV	-	3
VAUXHALL Astra, 3/5-dr Hatchback, 92-97	TÜV	-	3
VAUXHALL Astra, 5-dr Estate, 92-97	TÜV	-	3
VAUXHALL Astra, 5-dr Estate, 02-09	TÜV	-	3
VAUXHALL Meriva, 5-dr MPV, 03-06	-	-	2
VAUXHALL Meriva, 5-dr MPV, 10-	TÜV	-	3
VAUXHALL Omega, 5-dr Estate, 94-03	TÜV	-	3
VAUXHALL Vectra, 5-dr Estate, 96-02	-	-	3
VAUXHALL Vectra, 5-dr Estate, 03-05	TÜV	9115	3
VAUXHALL Vectra, 5-dr Estate, 06-08	TÜV	9115	3
VAUXHALL Zafira, 5-dr MPV, 98-04	-	-	2
VAUXHALL Zafira, 5-dr MPV, 05-11	-	-	1
VAUXHALL Zafira Family, 5-dr MPV, 11-	-	-	1
VAUXHALL Zafira Tourer, 5-dr MPV, 11-	TÜV	-	2
VOLKSWAGEN Bora, 5-dr Estate, 99-05	TÜV	-	3
VOLKSWAGEN Cross Golf, 5-dr Hatchback, 06-	TÜV	9115	3
VOLKSWAGEN Cross Touran, 5-dr MPV, 06-09	TÜV	9115	2
VOLKSWAGEN Golf III Variant, 5-dr Estate, 94-98	TÜV	9110	2
VOLKSWAGEN Golf IV Variant, 5-dr Estate, 99-06	TÜV	-	3
VOLKSWAGEN Golf V Variant, 5-dr Estate, 07-09	TÜV	9115	2
VOLKSWAGEN Golf VI Variant, 5-dr Estate, 10-12	TÜV	9115	3
VOLKSWAGEN Golf Plus, 5-dr Hatchback, 05-08	TÜV	-	2
VOLKSWAGEN Golf Plus, 5-dr Hatchback, 09-	TÜV	-	2
VOLKSWAGEN Passat, 5-dr Estate, 97-00	TÜV	-	3

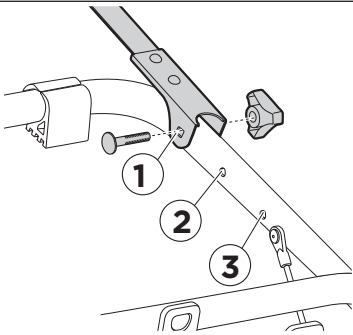
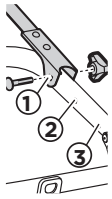
			
VOLKSWAGEN Passat, 5-dr Estate, 01-04	TÜV	-	3
VOLKSWAGEN Passat, 5-dr Estate, 05-10	TÜV	-	3
VOLKSWAGEN Passat, 5-dr Estate, 11-	TÜV	-	3
VOLKSWAGEN Passat Alltrack, 5-dr Estate, 12-	TÜV	-	3
VOLKSWAGEN Sharan, 5-dr MPV, 96-00	TÜV	9111	3
VOLKSWAGEN Sharan, 5-dr MPV, 01-09	TÜV	9111	3
VOLKSWAGEN Sharan, 5-dr MPV, 10-	TÜV	-	2
VOLKSWAGEN Touran, 5-dr MPV, 03-09	TÜV	9115	2
VOLKSWAGEN Touran, 5-dr MPV, 10-	TÜV	-	2
VOLVO 850, 5-dr Estate, 93-96	-	9110	2
VOLVO 940, 5-dr Estate, 90-96	TÜV	9110	2
VOLVO V70, 5-dr Estate, 97-99	-	9110	2
VOLVO V70, 5-dr Estate, 00-03	-	9110	2
VOLVO V70, 5-dr Estate, 04-07	-	9110	2
VOLVO XC70, 5-dr Estate, 00-07	-	9110	2



www.tuv.com  
ID 100000000

- EN** Tail lights and number plate lights are not concealed -Fulfils the requirements of TÜV.
- DE** Das Produkt verdeckt weder Rücklichter noch Nummernschild -die TÜV Anforderungen werden erfüllt.
- FR** Le produit ne cache ni les feux arrières, ni la plaque d'immatriculation -Conforme à la norme TÜV.
- NL** De achterlichten en de nummerplaatverlichting worden niet afgedekt -conform de eisen van TÜV .
- IT** I fanalini posteriori e le luci di illuminazione della targa non vengono coperti -Conforme ai requisiti TÜV.
- ES** Las luces de posición de cola y las luces de la matrícula no están ocultas -Cumple los requisitos de TÜV.
- PT** As luzes traseiras e de matrícula não estão escondidas -cumpre os requisitos da TÜV.
- SV** Produkten döljer ej bakljus och nummerplåt -Uppfyller kraven från TÜV.
- DK** Baglygter og nummerplade er ikke skjult - opfylder kravene fra TÜV.
- NE** Baklysene og nummerskiltbelysningen blir ikke tildekket. Oppfyller TÜV-kravene.
- FI** Ei peitä takavalvoja eikä rekisterikilven valoja -täyttää TÜV:n vaatimukset.
- ET** Tagatuled ja numbrimärgituled pole varjatud -vastab TÜV nõuetele.
- LV** Aizmugurējie lukturi un numura plāksnīte nav aizsegta -atbilst TÜV prasībām .
- LT** Neuždengiami užpakaliniai žibintai ir valstybinio numerio apšvietimo žibintai -atitinka TÜV reikalavimus.
- PL** Tyłne światła i oświetlenie tablicy rejestracyjnej nie są zakryte -spełnia wymogi TÜV.
- RU** Задние фонари и лампы освещения номерного знака не скрыты -соответствие требованиям TÜV.
- UK** Відповідно до вимог TÜV ніщо не має закрити задні фари автомобіля та лампи освітлення номерного знаку.
- BG** Задните светлини и светлините на регистрационния номер не са скрити - в съответствие с изискванията на TÜV.
- CS** Koncová světla a osvětlení registrační značky nejsou skrytá -splňuje požadavky TÜV.
- SK** Koncové svetlá a osvetlenie ŠPZ nie sú skryté -spĺňa požiadavky TÜV.
- SL** Izdelek ne zakriva zadnjih luči in luči za osvetlitev registrske tablice -zpolnjuje zahteve TÜV.
- HR/BiH** Proizvod ne pokriva stražnja svjetla niti svjetla za osvjetljavanje registracijske pločice -Ispunjava zahtjeve TÜV.
- RO** Luminile de poziție și cele ale plăcii de înmatriculare nu sunt ascunse - Respectă cerințele standardului TÜV.
- HU** Nem takarja a hátsó lámpákat és a rendszám megvilágítását -Megfelel a TÜV előírásainak.
- EL** Τα πίσω φώτα και τα φώτα της πινακίδας κυκλοφορίας δεν είναι καλυμμένα -Πληροί τις απαιτήσεις του TÜV.
- TR** Arka lambalar ve plaka lambaları kapanmıyor -TÜV şartlarını karşılıyor.

المصابيح الخلفية ومصباح اللوحات المعدنية غير محجوبة - حيث تستوفي متطلبات TÜV. **AR**

הפנסים האחוריים ופנסי לוחית הרישוי אינם מוסתרים - מומד בדרישות ה-TÜV. **HE**

**ZH** 不会遮挡尾灯和号牌灯——符合 TÜV 的要求。

**JA** テールライトやナンバープレート・ライトが隠れていない — TÜV の要件に適合していること。

**KO** TÜV의 요구 사항에 따라 미등 및 번호판 조명을 가리지 않습니다.

**TH** ไฟท้ายและไฟส่องป้ายทะเบียนจะไม่มีการปิดคลุมไว้เพื่อให้สอดคล้องกับข้อกำหนด TÜV