

U.I. Lapp GmbH	DATASHEET	
	EPIC® H-B 16 TGH	70100400 14.11.2013

Housing design H-B. The industry standard.
The housing standard. Wide choice for all applications



Automation



Industrial machinery and plant engineering



Mechanical resistance



Robust



Waterproof



Info

Universal, robust metal housings size H-B 16

Application range

Plant engineering
Light & sound technology
Plastics industry

Product features

Hood, high version
Bolts for double lever
Straight cable entry
Versions with / without neck

Remark

Photographs are not to scale and do not represent detailed images of the respective products.

Technical Data

Article:	H-B 16 TGH 29
PG:	29
Neck:	yes
Pieces / PU:	5
Material:	Housing: powder-coated aluminium alloy, grey Lever: zinc-plated steel Sealing: NBR
Protection rating:	IP 65 (latched)
Temperature range:	-40 °C to +100 °C, short-term up to +125 °C

Product Management	Document: EPIC® H-B 16 TGH	1 / 2
--------------------	----------------------------	-------

U.I. Lapp GmbH	DATASHEET	 LAPP GROUP
	EPIC® H-B 16 TGH	70100400 14.11.2013

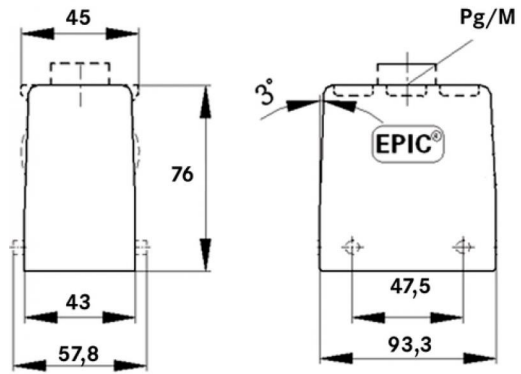

Product Management	Document: EPIC® H-B 16 TGH	2 / 2
--------------------	----------------------------	-------