

U.I. Lapp GmbH	DATASHEET	
	EPIC® MC Module Pneumatic 2pole	44424011 14.11.2013

The mixed assembly guarantees high flexibility. For applications in mechanical and plant engineering, for printing machines and slide-in technology.

The mix of different functions in one plug guarantees high flexibility

Assembly of individual connectors, suitable for different applications



Automation



Industrial machinery and plant engineering



Wind Energy



Info

Pneumatic modules with valve for 2.5 und 4mm tubings

Application range

Plant engineering

Printing machines

Control engineering

Remark

Photographs are not to scale and do not represent detailed images of the respective products.

Technical Data

Article:	MCB 2x4,0 PNEU (10)
Version:	female with valve
Contacts:	2
Maximum pressure (bar):	10
Pieces / PU:	10
Contacts:	Brass
Number of contacts:	2
Termination methods:	Plug-in connection: for hose with inner diameter 2.5 mm/4.0 mm
Cycle of mechanical operation:	100
Temperature range:	-20°C to +100°C

Product Management	Document: EPIC® MC Module Pneumatic 2pole	1 / 2
--------------------	---	-------

U.I. Lapp GmbH	<h1>DATASHEET</h1>	
	EPIC® MC Module Pneumatic 2pole	44424011 14.11.2013

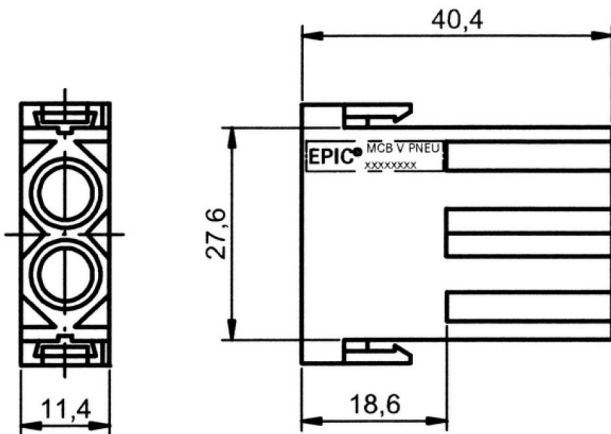
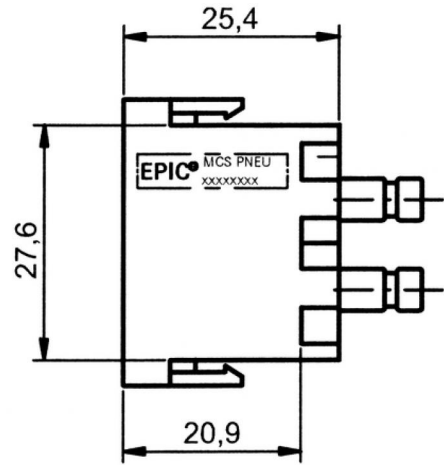

Product Management	Document: EPIC® MC Module Pneumatic 2pole	2 / 2
--------------------	---	-------