

IC-3116W

User Manual

11-2013 / v1.0

Edimax Technology Co., Ltd.

No.3, Wu-Chuan 3rd Road, Wu-Gu, New Taipei City 24891, Taiwan

Email: support@edimax.com.tw

Edimax Technology Europe B.V.

Nijverheidsweg 25, 5683 CJ Best, The Netherlands

Email: support@edimax.nl

Edimax Computer Company

3350 Scott Blvd., Bldg.15 Santa Clara, CA 95054, USA

Live Tech Support: 1(800) 652-6776

Email: support@edimax.com



Copyright © Edimax Technology Co., Ltd. all rights reserved. No part of this publication may be reproduced, transmitted, transcribed, stored in a retrieval system, or translated into any language or computer language, in any form or by any means, electronic, mechanical, magnetic, optical, chemical, manual or otherwise, without the prior written permission from Edimax Technology Co., Ltd.

Edimax Technology Co., Ltd. makes no representations or warranties, either expressed or implied, with respect to the contents hereof and specifically disclaims any warranties, merchantability, or fitness for any particular purpose. Any software described in this manual is sold or licensed as is. Should the programs prove defective following their purchase, the buyer (and not this company, its distributor, or its dealer) assumes the entire cost of all necessary servicing, repair, and any incidental or consequential damages resulting from any defect in the software. Edimax Technology Co., Ltd. reserves the right to revise this publication and to make changes from time to time in the contents hereof without the obligation to notify any person of such revision or changes.

The product you have purchased and the setup screen may appear slightly different from those shown in this QIG. For more information about this product, please refer to the user manual on the CD-ROM. The software and specifications are subject to change without notice. Please visit our website www.edimax.com for updates. All brand and product names mentioned in this manual are trademarks and/or registered trademarks of their respective holders.

Edimax Technology Co., Ltd.

Add: No. 3, Wu-Chuan 3rd Rd., Wu-Ku Industrial Park, New Taipei City, Taiwan

Tel: +886-2-77396888

Email: sales@edimax.com.tw

Notice According to GNU General Public License Version 2

Certain Edimax products include software code developed by third parties, software code is subject to the GNU General Public License ("GPL") or GNU Lesser General Public License ("LGPL"). Please see the [GNU](http://www.gnu.org) (www.gnu.org) and [LPGL](http://www.gnu.org)(www.gnu.org) Websites to view the terms of each license.

The GPL Code and LGPL Code used in Edimax products are distributed without any warranty and are subject to the copyrights of their authors. For details, see the GPL Code and LGPL Code licenses. You can download the firmware-files at <http://www.edimax.com> under "Download" page.

| | |
|---|-----------|
| I. Product Information..... | 5 |
| I-1. Package Contents | 5 |
| I-2. System Requirements | 5 |
| I-3. Back Panel | 6 |
| I-4. LED Status | 6 |
| I-5. Product Label | 7 |
| I-6. Reset | 8 |
| II. Hardware Installation..... | 9 |
| II-1. Mounting Kit | 9 |
| II-2. Camera | 9 |
| III. Camera Setup & EdiView Finder | 11 |
| III-1. EdiView Finder Network Camera Setup | 11 |
| III-1-1. Windows | 11 |
| III-1-2. Mac | 17 |
| III-2. Using EdiView Finder | 20 |
| III-3. WPS (Wi-Fi Protected Setup) | 22 |
| IV. Web-Based Management Interface | 23 |
| IV-1. Basic | 28 |
| IV-1-1. Network | 28 |
| IV-1-2. Wireless..... | 30 |
| IV-1-2-1. Smartphone | 31 |
| IV-1-2-2. Computer | 34 |
| IV-1-2-3. WPS..... | 35 |
| IV-1-3. Dynamic DNS..... | 36 |
| IV-1-4. RTSP | 37 |
| IV-1-5. Date & Time | 38 |
| IV-1-6. Users | 39 |
| IV-1-7. UPnP..... | 41 |
| IV-1-8. Bonjour | 42 |
| IV-2. Video | 43 |
| IV-2-1. Video Settings | 43 |
| IV-2-2. Image Appearance | 45 |
| IV-2-3. Night Vision..... | 46 |
| IV-3. Events..... | 47 |
| IV-3-1. Motion Detection..... | 47 |
| IV-3-2. Detection Region | 49 |

| | | |
|-------------|---|------------|
| IV-3-3. | Schedule Settings..... | 51 |
| IV-3-4. | SMTP | 53 |
| IV-3-5. | FTP..... | 55 |
| IV-4. | System..... | 56 |
| IV-4-1. | Basic | 56 |
| IV-4-2. | Advanced | 57 |
| IV-4-3. | Cloud Service..... | 59 |
| IV-5. | Status | 60 |
| IV-5-1. | System Information | 60 |
| IV-5-2. | System Log | 62 |
| V. | Myedimax.com | 63 |
| VI. | 16 Channel Viewer for Windows..... | 66 |
| VI-1. | Installation | 66 |
| VI-2. | Using the 16 Channel Viewer..... | 70 |
| VI-3. | Configuring the 16 Channel Viewer | 73 |
| VI-3-1. | Camera Configuration..... | 73 |
| VI-3-1-1. | Camera..... | 74 |
| VI-3-1-2. | Scheduled Recording | 76 |
| VI-3-1-3. | Audio..... | 79 |
| VI-3-1-4. | Motion Recording | 80 |
| VI-3-2. | General Options..... | 82 |
| VI-3-2-1. | General..... | 82 |
| VI-3-2-2. | Email Setting | 84 |
| VI-3-2-3. | Security | 87 |
| VI-3-2-4. | About | 89 |
| VI-4. | Changing the Display Layout..... | 90 |
| VI-5. | Full Screen Mode | 93 |
| VI-6. | Scan..... | 94 |
| VI-7. | Zoom In/Out | 95 |
| VI-8. | Pan & Tilt..... | 96 |
| VI-9. | Snapshot | 97 |
| VI-10. | Recording | 98 |
| VI-11. | Video Playback..... | 99 |
| VII. | EdiView App..... | 100 |

I. Product Information

I-1. Package Contents



IC-3116W



QIG



CD-ROM



Power Adapter

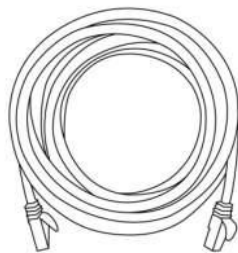

Ethernet Cable

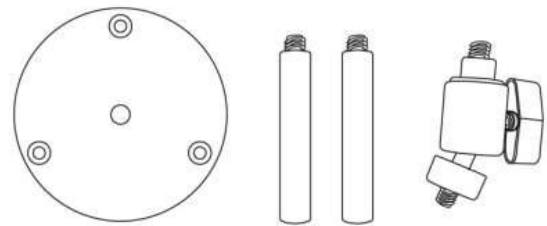

Mounting Kit

I-2. System Requirements

- Intel Pentium 4 2.4GHz (above or similar)
- VGA card (1024*768 or above)
- CD-ROM Drive
- At least 128MB hard disk space (256 MB recommended)
- Windows 2000, XP, Vista, 7 or 8
- Web browser (Internet Explorer 7.0, Firefox 3.6, Chrome 10, Opera 11, Safari 5 or above)

I-3. Back Panel

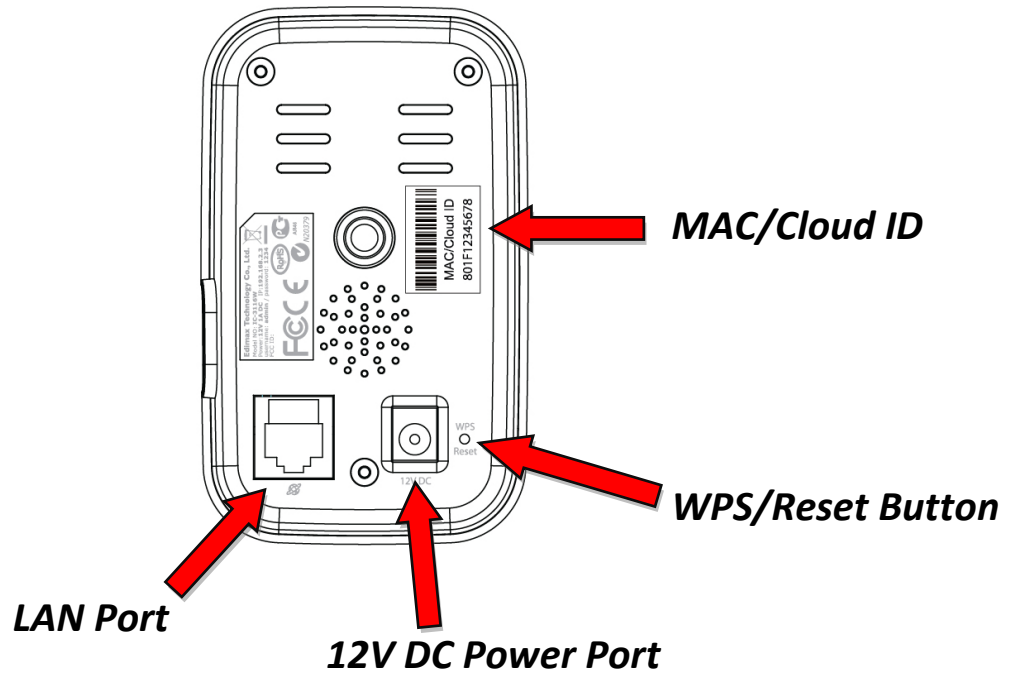

I-4. LED Status

| LED | LED Color | LED Status | Description |
|----------|-----------|---------------------------------|--|
| Power | Green | On | Network camera is on and connected to cloud server. |
| | | Quick Flashing | Network camera is restarting. |
| | | Slow Flashing (1 x per second) | Network camera is starting up OR network camera is not connected to cloud server. |
| LAN | Green | On | Network camera is connected to the local network. |
| | | Quick Flashing | LAN activity (transferring data). |
| | | Slow Flashing (1 x per second) | WPS is active. |
| Internet | Orange | On | Connected to Internet. |
| | | Slow Flashing (1 x per second) | Not connected to Internet. |

I-5. Product Label

The product label located on the back of the camera displays the MAC address and cloud ID of your network camera.

 ***The MAC address and cloud ID are the same for easy reference.***

The cloud ID allows you to view a live stream from your network camera remotely (from any Internet connection) as described later in III-4.

Myedimax.com.

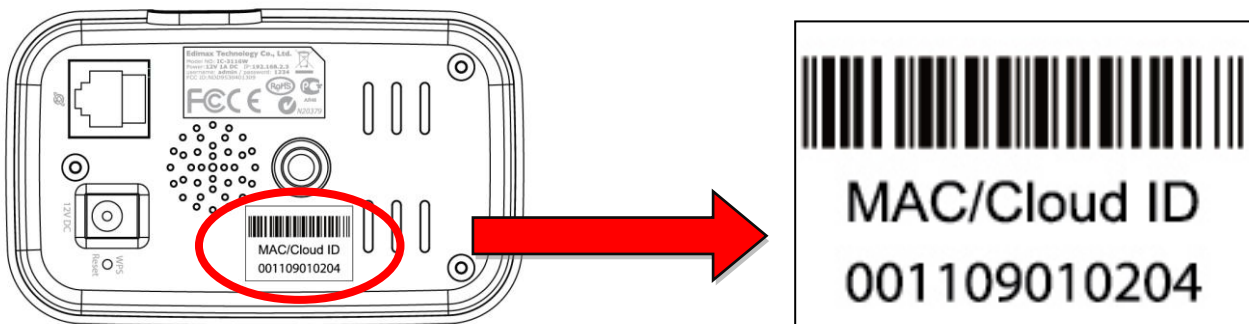

I-6. Reset

If you experience problems with your network camera, you can reset the camera back to its factory default settings. This resets **all** settings back to default.

- 1.** Press and hold the WPS/Reset button found on the back panel for at least 10 seconds
- 2.** Release the button when the **green** power LED is **flashing quickly**.
- 3.** Wait for the network camera to restart. The camera is ready when the **green** power LED is **on**.



After reset, the green power LED will display slow flashing if the network camera is unable to connect to the cloud server.

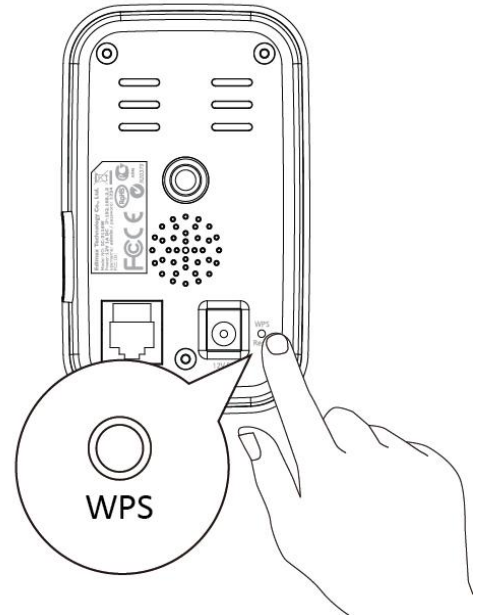

II. Hardware Installation

II-1. Mounting Kit

A stand for your network camera is included in the package contents. The stand requires some assembly.

1. Assemble the included camera stand as shown below. The camera stand can stand by itself or be mounted to a wall:

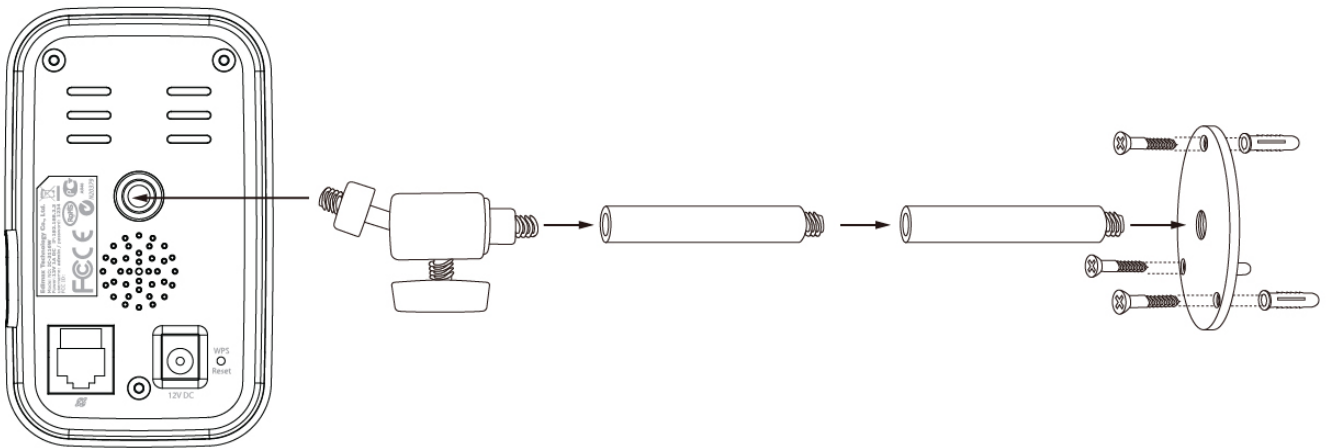

2. Secure the network camera to the included camera stand using the mounting hole on the rear of the camera.



You can also mount the network camera to a tripod using the mounting hole.

II-2. Camera

Follow the instructions below to ensure your camera is properly connected and ready for setup.

1. Use an Ethernet cable to connect the network camera's LAN port to a router/switch/access point's LAN port, as shown below.

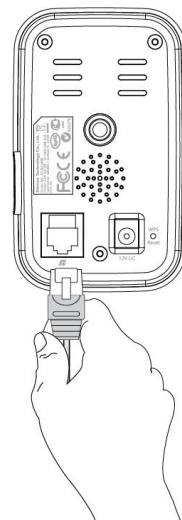

2. Connect the power adapter to the network camera's power port and to a power supply, as shown below.

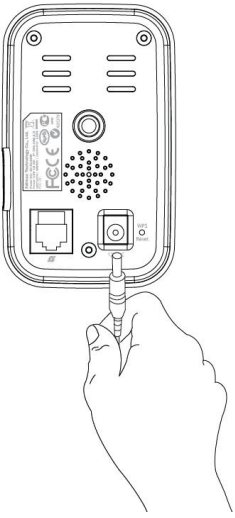

3. Wait a moment for the camera to power on. The camera is ready when the **green** power LED displays **on**. Please refer to **III. Camera Setup & EdiView Finder** to setup your network camera.

III. Camera Setup & EdiView Finder

Your network camera can be up and running in just a few minutes. First, please follow the instructions below for **Windows** or **Mac** in **III-1. Installing & Using EdiView Finder** to install the EdiView Finder software and connect your camera to your wireless network.

Or you can follow **III-3. WPS** as an alternative method to connect your network camera to your wireless network.

Then, you can use the web based management interface to watch a live stream and further configure the camera if you need (see **IV.**).

Additionally, you can view the camera's live image using either the cloud ID (see **V.**), the 16 channel viewer software (see **VI.**), or the EdiView smartphone app (see **VII.**).

III-1. EdiView Finder Network Camera Setup



Ensure your computer is connected to the same router as the network camera.

III-1-1. Windows

1. Insert the included CD into your CD-ROM drive and if the setup utility does not automatically open, please locate and open the "Autorun.exe" file in the "Autorun" folder.
2. Click "Setup Utility" to install the EdiView Finder software utility.

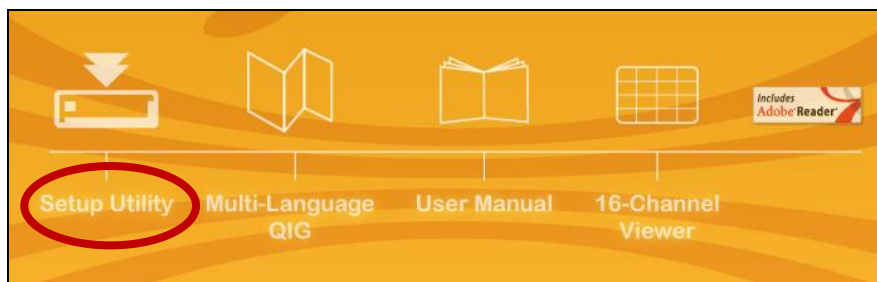

3. Click "Next" and follow the on-screen instructions to install the EdiView Finder software utility.

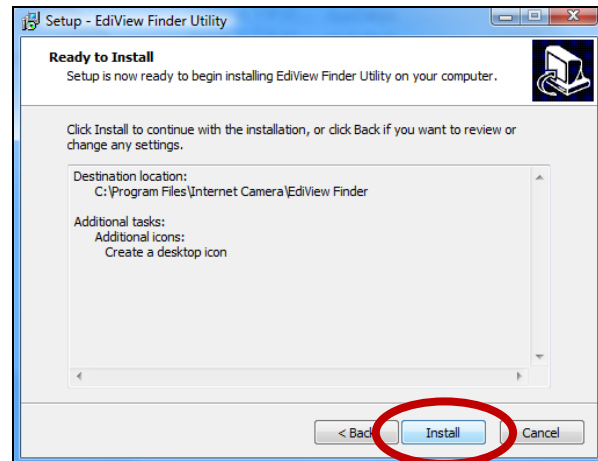
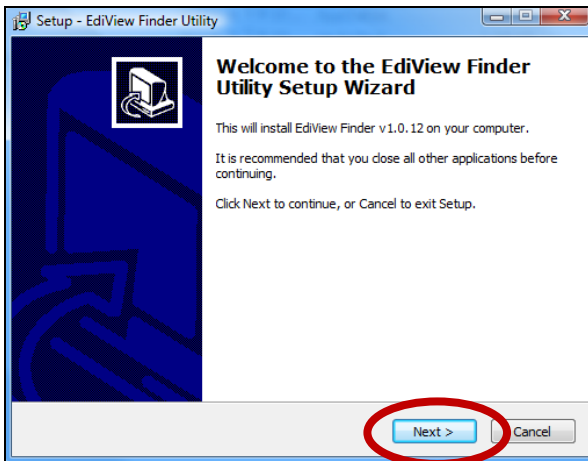

4. When installation is complete, select “Launch EdiView Finder Utility” before clicking “Finish”. Or double click the “EdiView Finder Utility” icon on your desktop to launch EdiView Finder.

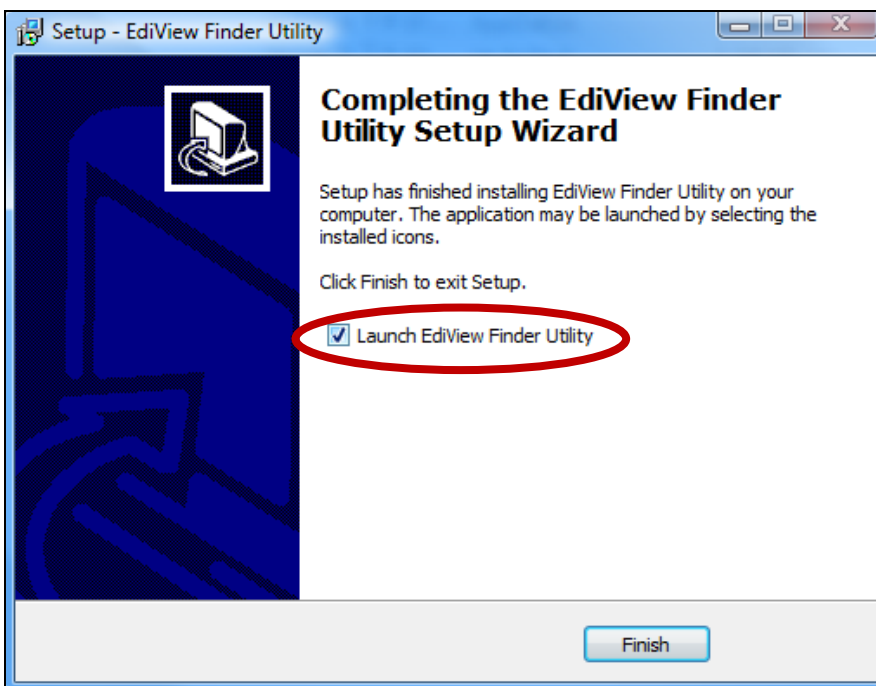

5. EdiView Finder will list all cameras on your local network, along with each camera’s name, model, IP address and MAC address.



Click the search icon to refresh the list if your camera is not displayed.

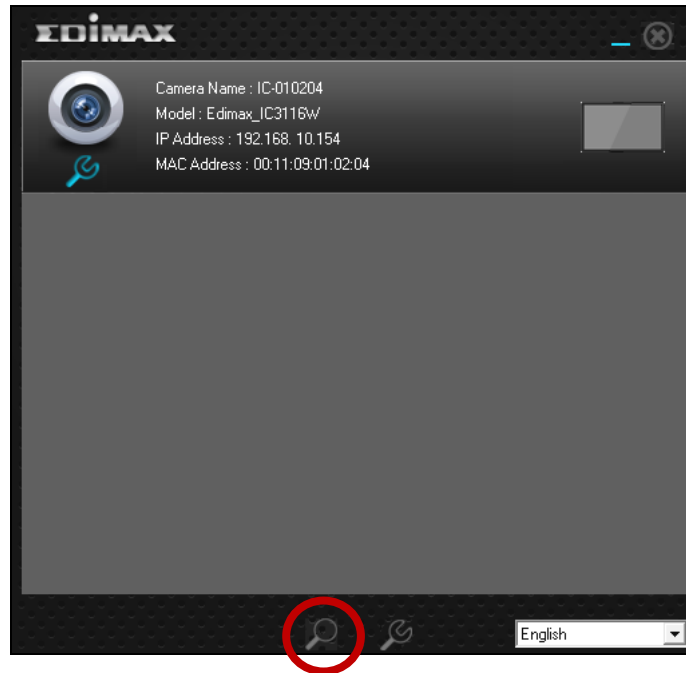

 ***The network camera's IP address is displayed on this screen. After setup, you can enter this IP address into the URL bar of a web browser on the same local network to access your network camera's web-based configuration interface.***

6. Double click your camera and then choose “Yes” or “No” if you wish to set up a wireless connection. If you choose “No” please go to **step 10**.

 ***The IC-3116W is a wireless camera, please choose “Yes” to set up your wireless connection.***



7. Select your wireless network from the list and enter the correct password in the "Password" field, before clicking "OK". This is the wireless network which your camera will connect to.

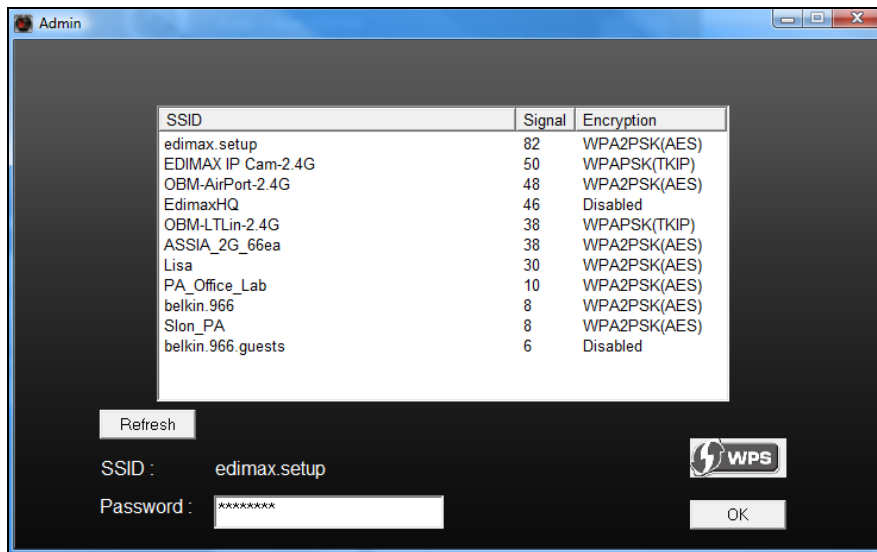

8. Unplug the Ethernet cable from your network camera and click "Next". Please wait a moment for the camera to detect the connection.

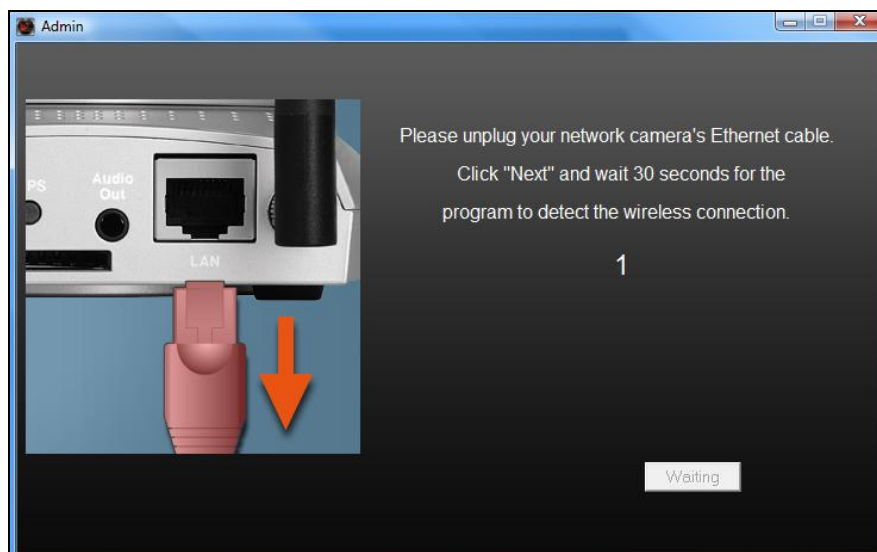

9. When the connection is detected as shown below, please click “Next”.

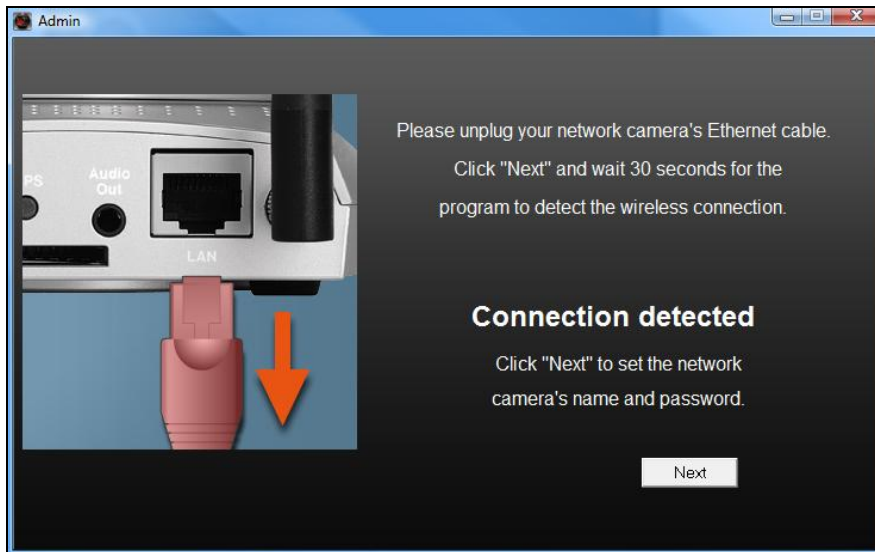

10. Enter a name and password for your camera. The password will be used later to log in to your camera remotely via its cloud ID, web interface or via the EdiView smartphone app. Click “OK” to continue.

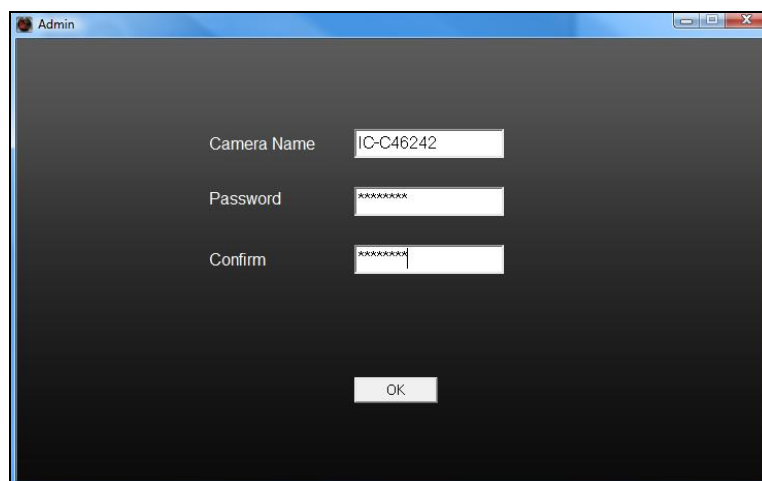

- 11.** The next screen will indicate that setup is complete. The camera is operational and ready for use. Click “OK” and a preview window showing a live stream from your camera may open.



III-1-2. Mac



EdiView Finder for Mac will not set up your network camera's wireless connection. After this chapter, please continue to IV-1-2. Wireless to set up the camera's wireless connection.

- 1.** Insert the included CD into your CD-ROM drive and browse to the "Mac" folder.

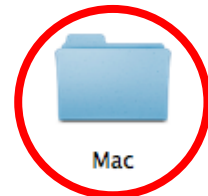

- 2.** Copy the "EdiView Finder" file to your desktop and double click the icon to open EdiView Finder.



EdiView Finder is also available for download from the Edimax website:

<http://www.edimax.com/EdiViewFinder.htm>



3.EdiView Finder will list all cameras on your local network, along with each camera’s name, model, IP address and MAC address.

 **Click the search icon to refresh the list if your camera is not displayed.**

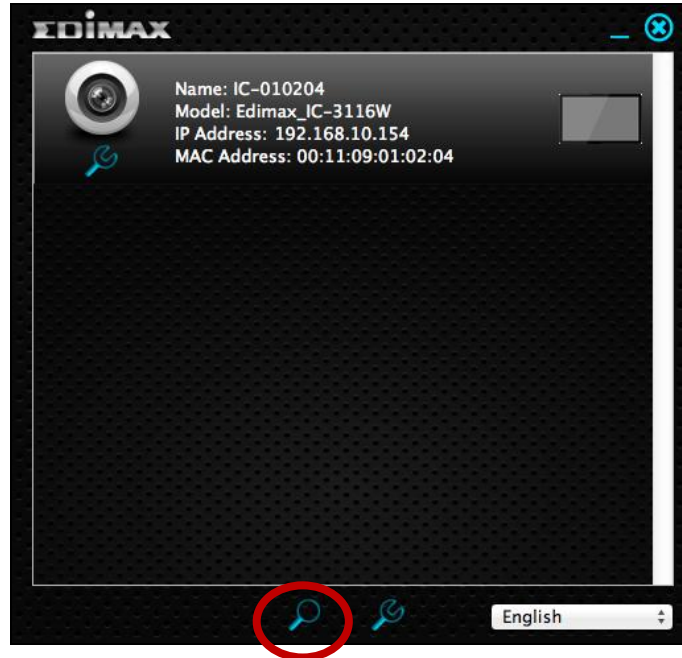

 **The network camera’s IP address is displayed on this screen. After setup, you can enter this IP address into the URL bar of a web browser on the same local network to access your network camera’s web-based configuration interface.**

4. Double click your network camera and wait a moment for the network camera to obtain an IP address and test the cloud connection. EdiView should display “Success” as shown below.

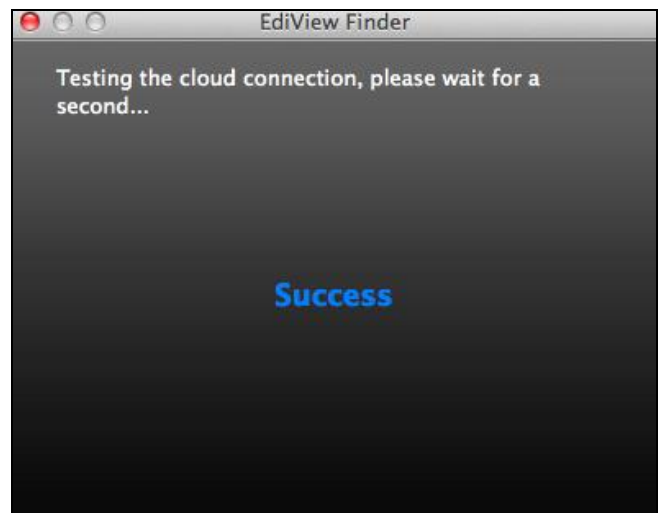
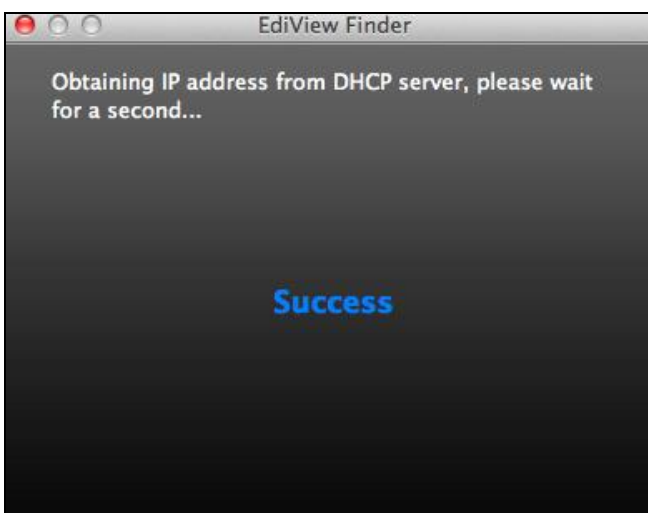

- 12.** Enter a name and password for your camera. The password will be used later to log in to your camera remotely via its cloud ID, web interface or via the EdiView smartphone app. Click “Next” to continue.



- 13.** The next screen will indicate that setup is complete. The camera is operational and ready to be configured for a wireless connection. Click “Finish” and a preview window showing a live stream from your camera may open.

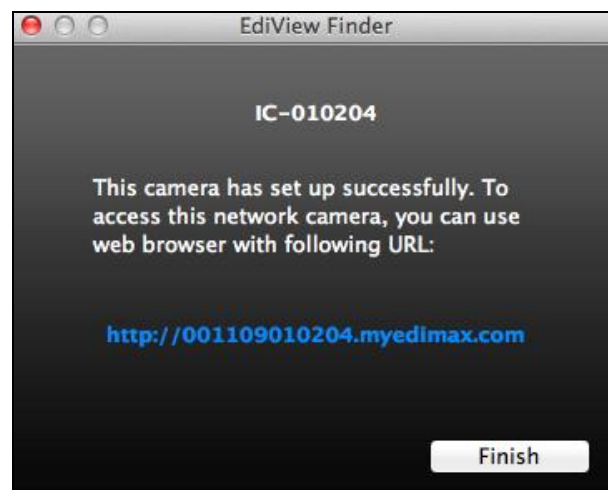

- 14.** To setup your network camera’s wireless connection, please follow **IV-1-2. Wireless.**

III-2. Using EdiView Finder

You can also use EdiView Finder to find your network camera's IP address, view a live stream, or modify the network camera's IP address. Double click the TV icon on the right side to view a live stream in a pop-up window, or click the wrench icon to open a new window with the network camera's IP address settings:

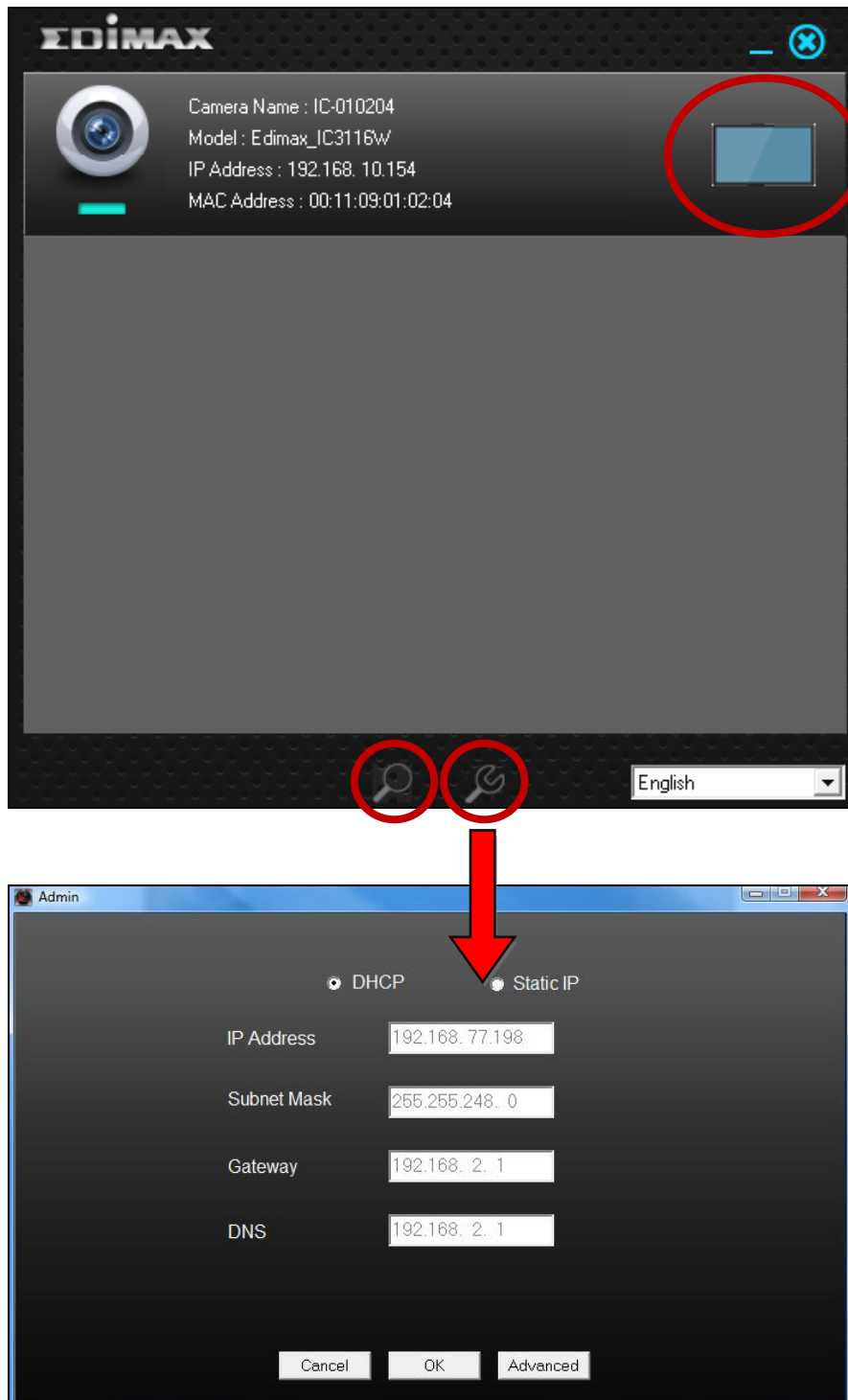



EdiView Finder will locate your network camera as long as you are on the same local network. Static IP users who may be using a different IP address subnet to the network camera should still be able to locate the network camera with EdiView Finder. If you encounter difficulties, it is recommended that you use a DHCP server – though you can manually set the network camera’s IP address using EdiView Finder (above) or using the web-based configuration interface (see IV-1-1. Network) if you need.

III-3. WPS (Wi-Fi Protected Setup)

The WPS button is a quick and easy method to establish a secure wireless connection between your network camera and your wireless router/access point.

1. Press and hold the WPS button on your **wireless router/access point** for the correct length of time to activate its WPS.



Please check the instructions for your wireless router/access point for how long you need to hold down its WPS button to activate WPS.

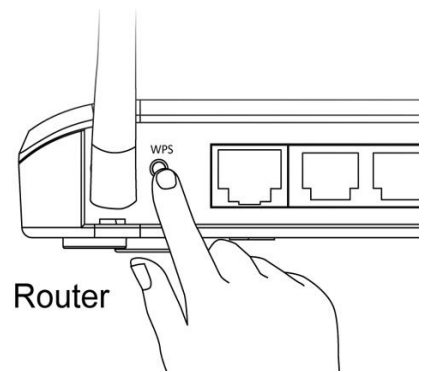

2. Within two minutes, press the WPS/Reset button on the network camera for 2 – 5 seconds to activate WPS. The **green** LAN LED will **flash slowly** to indicate that WPS is active.



Take care not to hold the WPS/Reset button too long and reset your network camera (see I-6.)

3. The devices will establish a secure wireless connection.

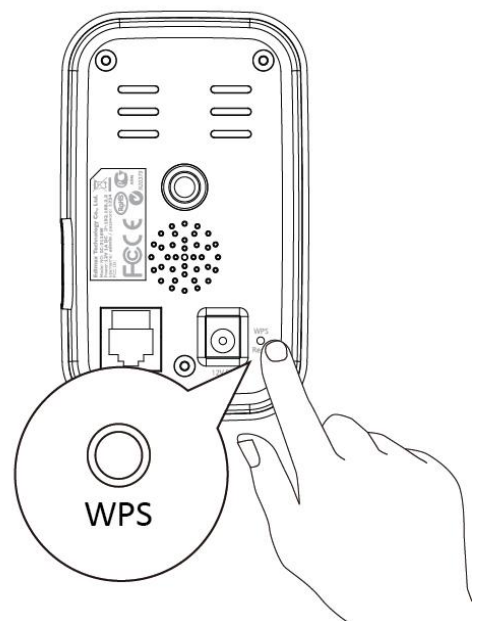

IV. Web-Based Management Interface

When you are using the **same** local network as your camera, you can use the web-based management interface to view or configure the camera.

You can access the web-based management interface with a web browser on a smartphone or computer. For smartphone users, the appearance of the interface will vary slightly to that which is displayed here, though the menu functions which are described later from **IV-1. Basic** onwards are essentially the same.

1. Enter the network camera's IP address into the URL bar of a web browser. The camera's IP address can be found by opening EdiView Finder, as displayed below:

 **Internet Explorer is recommended.**

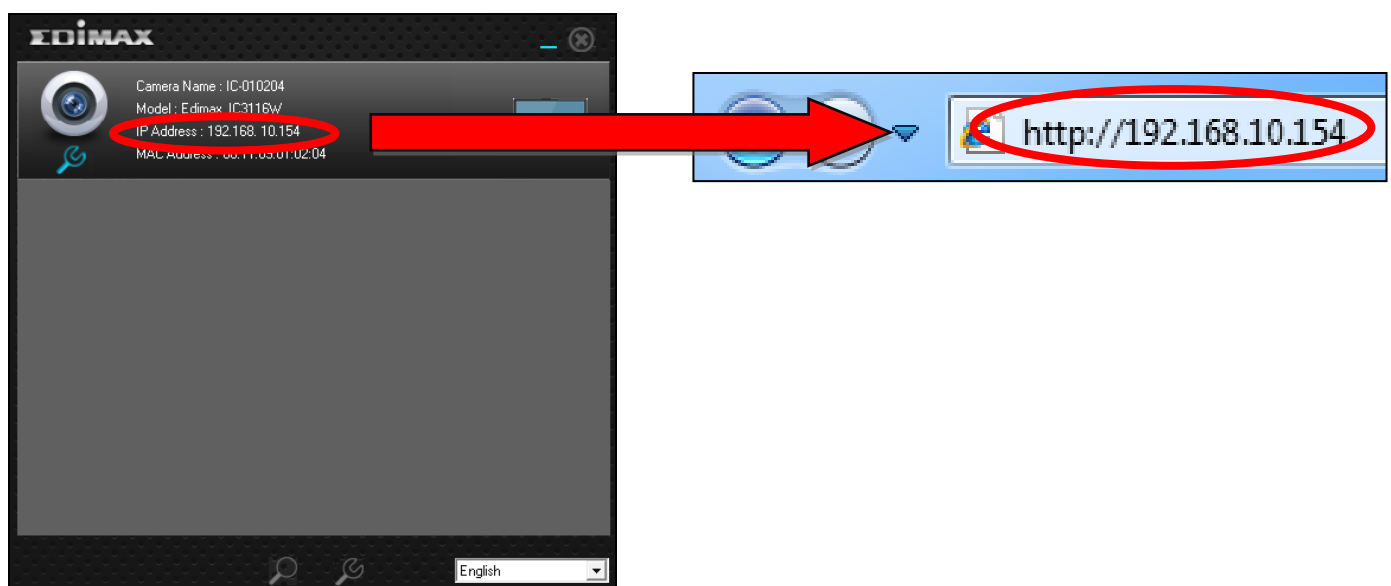

2. You may be prompted to allow a Java add-on to run. Please click the message where it says “click here” and then click “Run Add-on”.

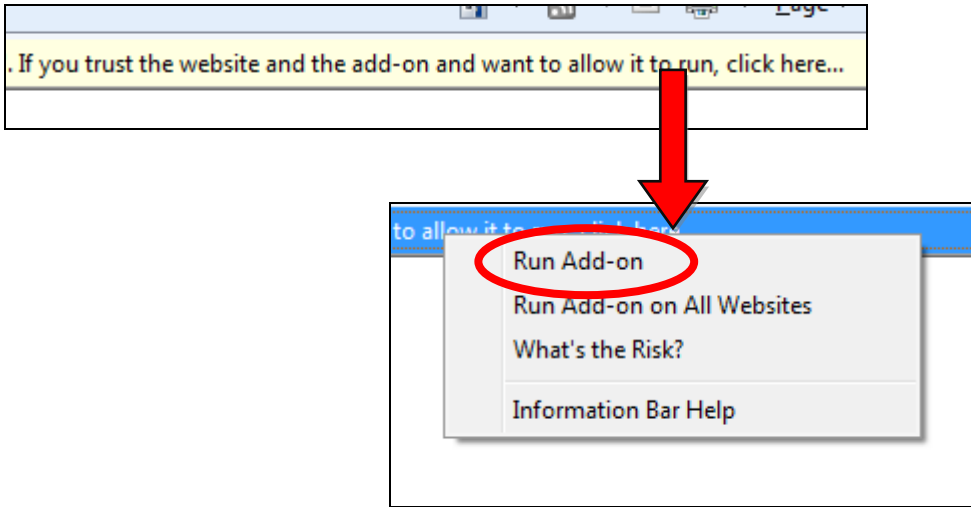

 ***If any other security warnings/prompts appear, please select “Run” or “Allow” or similar, depending on your browser.***

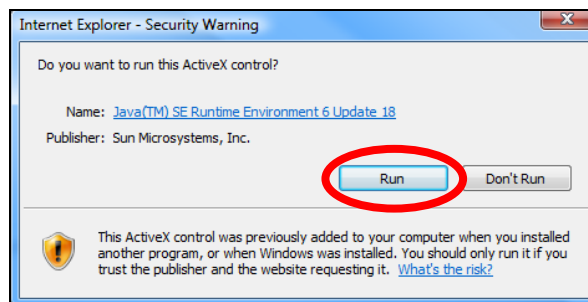



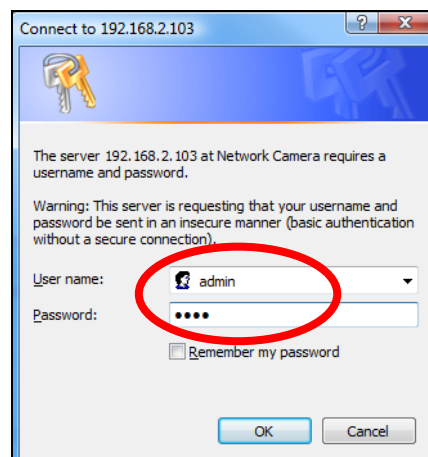

3. Enter the username and password for your network camera (default username: *admin* default password: *1234*). The network camera’s web-based management interface will then be displayed in your browser.

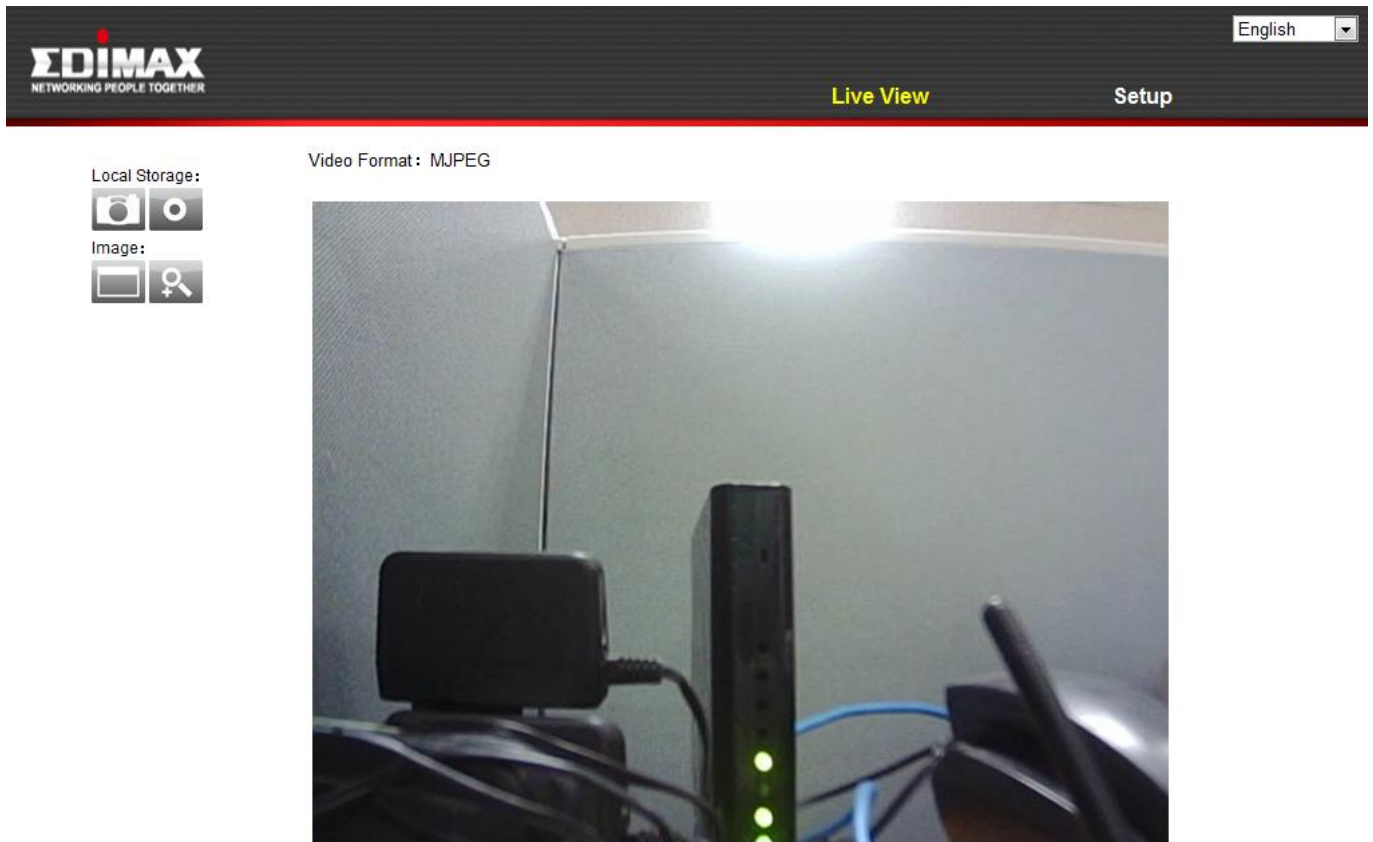

4. For computer users, the “Live View” screen will be displayed, as shown below. On the live view screen you can see a live stream from your camera and utilize various camera controls using the icons on the left side.



| | |
|--|--|
| Snapshot  | Save a snapshot (image) of the network camera’s current view. You will be prompted to select a location to save the image. |
| Record  | Record video. You will be prompted to select a location to save the recording. The icon will display blue while recording, click the icon again to stop recording. |
| Full Screen  | Expand the live view of the network camera to full screen mode. Press the “Esc” key on your keyboard to exit full screen. |
| Digital Zoom  | Click to open the digital zoom window: |

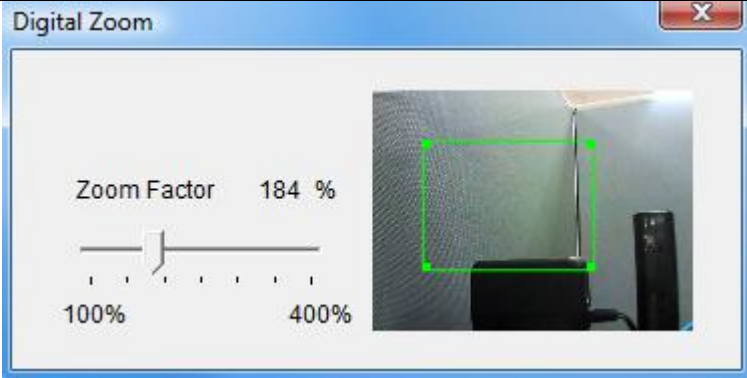

Digital Zoom

Zoom Factor 184 %

100% 400%

Adjust the level of zoom from 100% to 400% using the “Zoom Factor” slide bar and move the green box to the section of the image you wish to zoom on. The enlarged/zoomed view will be displayed in the main window.

5. Select “Setup” in the top right corner and use the menu down the left side to navigate to the network camera’s various settings. Each menu item is described in the following chapters.

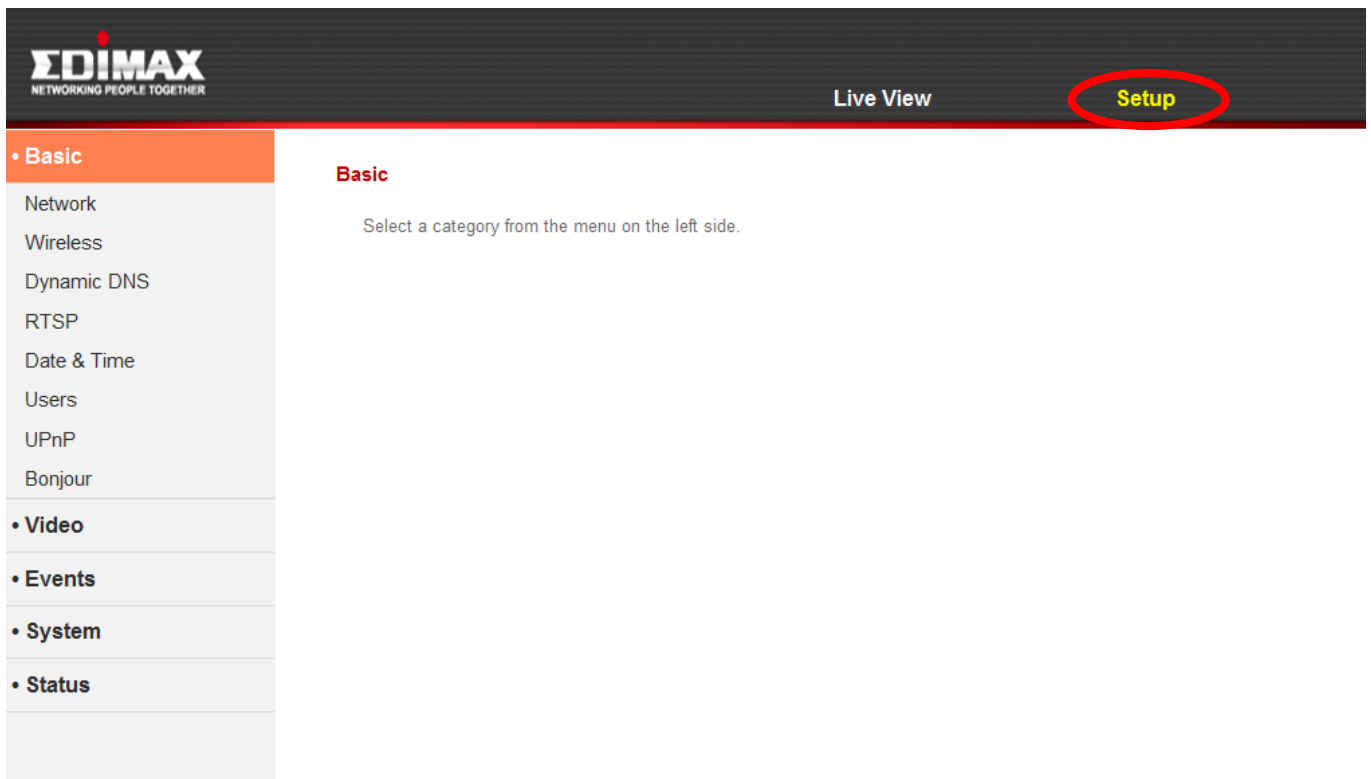

EDIMAX NETWORKING PEOPLE TOGETHER

Live View **Setup**

- Basic
 - Network
 - Wireless
 - Dynamic DNS
 - RTSP
 - Date & Time
 - Users
 - UPnP
 - Bonjour
- Video
- Events
- System
- Status

Basic

Select a category from the menu on the left side.

6. After making any changes, click “Save Settings” to save the settings and bring the changes into effect.

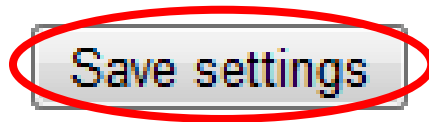

IV-1. Basic

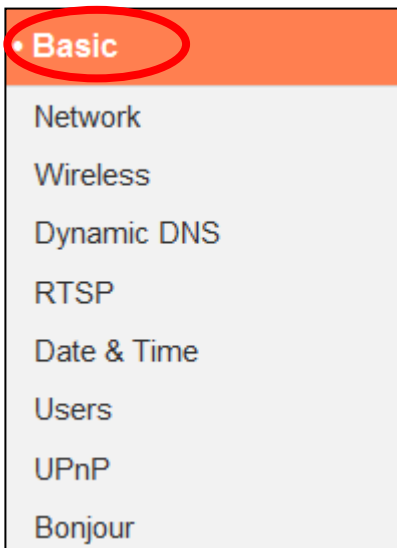

The “Basic” menu opens a submenu with eight categories of settings for your network camera’s basic operation. Select a category and refer to the appropriate chapter.

IV-1-1. Network

Local network settings are displayed on this page, as shown below:

Network

Network Type:

- Static IP
- DHCP

Static IP

IP Address:

Subnet Mask:

Gateway:

Primary DNS:

Secondary DNS:

HTTP Port:

| | |
|---------------------|--|
| Network Type | Select “DHCP” to automatically assign an IP address to your network camera from your router, or “Static IP” to manually set a static IP address. |
|---------------------|--|

| | |
|----------------------|---|
| IP Address | Specify an IP address here, which will be the IP address of your network camera. |
| Subnet Mask | Enter the subnet mask of the IP address. |
| Gateway | Enter the gateway address of your network. |
| Primary DNS | Enter the IP address of your primary DNS server. |
| Secondary DNS | Enter the IP address of your secondary DNS server (optional). |
| HTTP Port | You can edit the HTTP port number to any value between 1024 – 65535. The default value is 80. |

IV-1-2. Wireless

The wireless page allows you to configure settings for your network camera's wireless connection. For Windows users, your wireless connection should have been set up already using EdiView Finder, though you can still use this page to revise the settings if you need.

Mac users need to configure these settings manually since EdiView Finder on Mac will not set up your camera's wireless connection. A quick guide to set up your network camera's wireless connection using a smartphone or a computer is included below.



Mac users setting their network camera's wireless connection for the first time please ensure your network camera is connected to your router/access point/switch via Ethernet cable.

You can also use the "wireless" page for Wi-Fi Protected Setup (WPS): to either activate push-button WPS (the same effect as physically pushing the hardware WPS button built into the camera), or PIN code WPS (using a PIN code for verification between the two wireless devices for additional security.)

IV-1-2-1. Smartphone

1. Select “Basic” from the menu on the left side and then select “Wireless”.

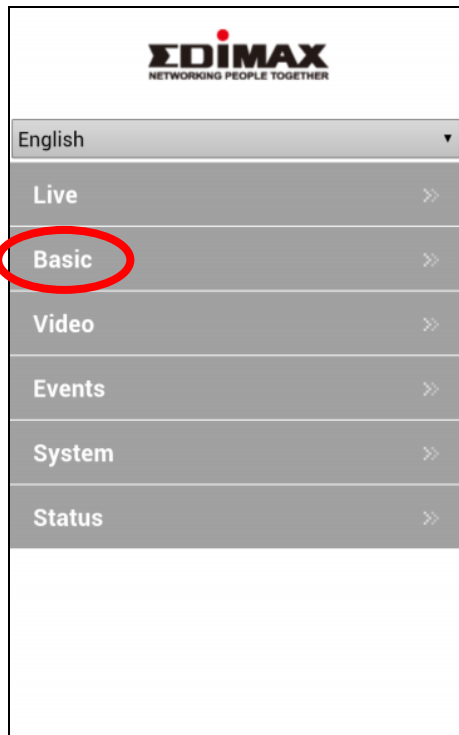

2. Configure the wireless settings A – E shown in the table below:

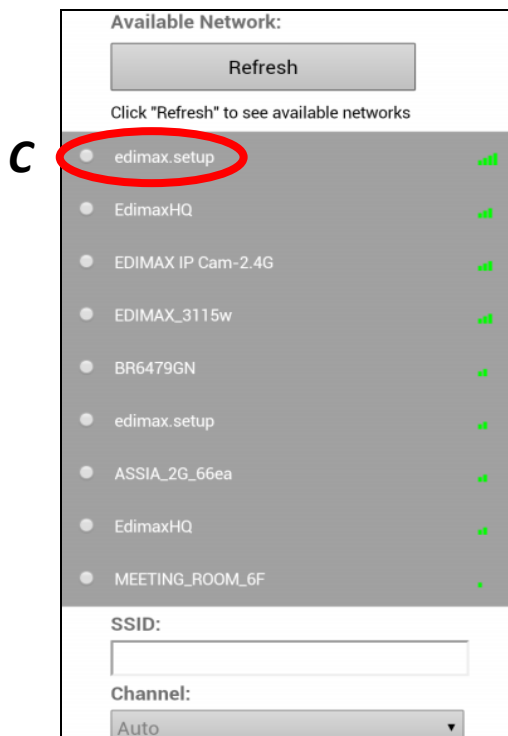
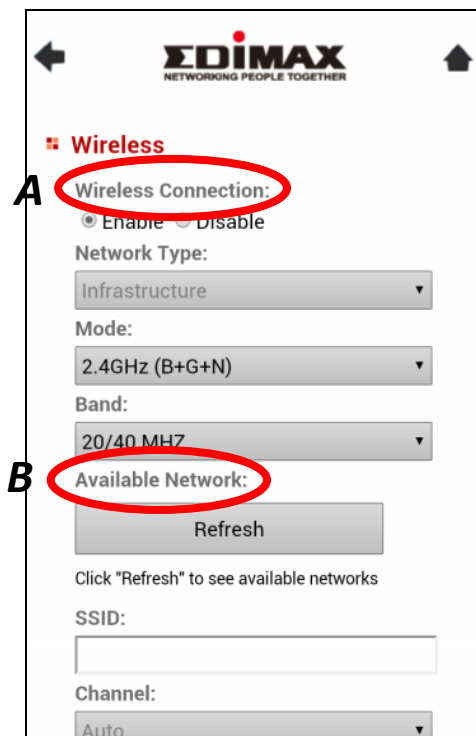

D

SSID:
edimax.setup

Channel:
Auto

Authentication:
WPA2 PSK

Encryption Type:
AES

WPA Pre Shared Key:
abcd1234

WEP Key Format:
HEX

WEP Key Length:
64-Bit

Default Key:
1

WEP Key 1:
[]

WEP Key 2:
[]

WEP Key 3:
[]

WEP Key 2:
[]

WEP Key 3:
[]

WEP Key 4:
[]

E Save settings

WPS

Self PinCode:
90588235

Access PBC mode:
Start PBC

Configure via PinCode:
Registrar SSID:
[]

Start PIN

| | | |
|----------|------------------------------|--|
| A | Wireless Connection | Select "Enable" to enable the wireless connection. |
| B | Available Network (1) | Click "Refresh" to display all available Wi-Fi networks. |
| C | Available Network (2) | Select your Wi-Fi network from the list. This is the wireless network which your camera will connect to. |
| D | WPA Pre Shared Key | Enter your Wi-Fi password. |
| E | Save Settings | Click "Save Settings" to save your settings. |

- 3.** After the settings are saved, remove the Ethernet cable from your network camera. Your camera should now be connected to your Wi-Fi.

IV-1-2-2. Computer

1. Configure the wireless settings **A – E** shown in the table below:

The screenshot shows the 'Wireless' settings page. At the top, there are radio buttons for 'Wireless Connection' (labeled **A**) with 'Enable' selected and 'Disable' unselected. Below that is the 'Available Network' section (labeled **B**) with a 'Refresh' button and the text 'Click "Refresh" to see available networks'. A table of available networks is shown below (labeled **C**), with the first row selected. The table has columns: Connected, SSID, BSSID, Signal, Channel, Encryption, and Network Type. Below the table are configuration options: SSID (text input), Authentication (dropdown: WPA2 PSK), Encryption Type (dropdown: AES), WPA Pre Shared Key (password field, labeled **D**), WEP Key Format (dropdown: ASCII), WEP Key Length (dropdown: 64-Bit), Default Key (dropdown: 1), and four WEP Key input fields. At the bottom is a 'Save settings' button (labeled **E**).

| | | |
|----------|----------------------------|--|
| A | Wireless Connection | Select "Enable" to enable the wireless connection. |
| B | Available Network | Click "Refresh" to display all available Wi-Fi networks. |
| C | Connected | Select your Wi-Fi network from the list. This is the wireless network which your camera will connect to. |
| D | WPA Pre Shared Key | Enter your Wi-Fi password. |
| E | Save Settings | Click "Save Settings" to save your settings. |

2. After the settings are saved, remove the Ethernet cable from your network camera. Your camera should now be connected to your Wi-Fi.

IV-1-2-3. WPS

WPS (Wi-Fi Protected Setup) is a quick and easy way to set up wireless connections between compatible devices. Use the “Start PBC” or “Start PIN” button to activate WPS on your network camera. Your network camera’s WPS PIN code is also listed next to “Self PinCode”.

WPS

Self PinCode: 90588235

Access PBC mode:

Configure via PinCode: Registrar SSID:

| | |
|------------------------------|---|
| Self PinCode | Your network camera’s WPS PIN code is listed here. |
| Access PBC Mode | Click “Start PBC” to activate push-button WPS on your network camera. This has the same effect as physically pushing the built-in hardware WPS button. |
| Configure via PinCode | Enter the SSID you wish to connect to and click “Start PIN” to activate PIN code WPS. You will then need to enter the network camera’s “Self PinCode” into your wireless router’s web U.I. and activate your router’s PIN code WPS. |



Please refer to your wireless router’s instructions for help accessing its web-based interface and activating WPS.

IV-1-3. Dynamic DNS

Dynamic DNS (DDNS) is a service which provides a hostname-to-IP service for dynamic IP users. If your Internet service provider didn't issue a fixed IP address, you can use a third-party dynamic DNS provider to map your current IP address to a fixed IP address. Several free or paid DDNS services are available online, please use the information provided by your DDNS provider to configure the settings on this page.

Dynamic DNS

Enable DDNS: Enable Disable

Provider:

Host Name:

Username:

Password:

| | |
|--------------------|--|
| Enable DDNS | Select "Enable" to enable DDNS functionality, or select "Disable" to disable DDNS functionality. |
| Provider | Select your dynamic DNS service provider from the dropdown menu. |
| Host Name | Enter the hostname you registered with the DDNS service provider. |
| User Name | Enter the user name you registered with the DDNS service provider. |
| Password | Enter the password you registered with the DDNS service provider. |

IV-1-4. RTSP

Real Time Streaming Protocol (RTSP) enables the network camera to be used with a streaming media server. Enter the required RTSP settings.

RTSP Settings

RTSP Port:

MJPEG RTSP Path: .sdp

RTP Port Range: -

Verification: ▼

| | |
|------------------------|---|
| RTSP Port | Enter the RTSP port. |
| MJPEG RTSP Path | Enter the MJPEG RTSP path. |
| RTP Port Range | Enter the RTP port range. |
| Verification | Select a verification type from the drop down menu. |

IV-1-5. Date & Time

You can set and adjust the network camera's system time and date on this page. Maintaining a correct system time is particularly important for recorded video organization/playback.

Date & Time

Mode: NTP Manual Setting

Set Time & Date Manually: / / : :

NTP Server:

Time Zone:

Daylight Saving: Enable Disable

| | |
|-------------------------------------|--|
| Mode | Select "NTP" or "Manual Setting". NTP (Network Time Protocol) can set and maintain the time and date automatically via an NTP server on the local network, if available. |
| Set Time & Date Manually | For manual setting mode, enter the correct time and date in the following format: YYYY/MM/DD HH:MM:SS |
| Synchronize to PC time | Click here to automatically enter the same time and date as your computer. |
| NTP Server | For NTP mode, enter the NTP server's hostname or IP address. |
| Time Zone | Select the correct time zone. |
| Daylight Saving | Enable or disable daylight saving according your local time zone. |

IV-1-6. Users

In addition to the default administrator account, you can configure several different login accounts for the network camera, with two different levels of access – operator and guest.

Operator accounts can configure all functions of the network camera in the same way as the administrator account, while guest accounts can only view the camera's image.

Users

User List: edimax : Operator

User Name:

Password:

Confirm Password:

Authority: Operator Guest

Anonymous Login: Enable Disable

| | |
|-------------------------|--|
| User List | Existing users are listed here. Select a user here to modify the settings. |
| User Name | Input user's name here. |
| Password | Input user's password here. |
| Confirm password | Input user's password here again for confirmation. |

| | |
|------------------------|---|
| Authority | Select the user's authority: Operators can view video and configure all settings, while guests can only view video. |
| Add | Add a new user. |
| Modify | Save the changes to an existing, selected user. |
| Remove | Remove selected user. |
| Anonymous Login | Enable or disable anonymous login. Anonymous login allows anyone to login to the network camera and view images. This function is useful if you want to setup a remote video server. |

IV-1-7. UPnP

Universal plug-and-play (UPnP) is a set of networking protocols which enables network devices to communicate and automatically establish working configurations with each other. When enabled, Windows computers can automatically discover the network camera on the local area network. The network camera also supports IGD.

UPnP

Enable Disable

[Save settings](#)

IGD (UPnP Port Forward)

IGD Enable (UPnP Port Forward) : Enable Disable

IGD Configuration (External Port) : IGD Fully Automation (Auto) IGD Semi Automation (Manually)

External HTTP Port :

External RTSP Port :

| | |
|--|--|
| Enable/Disable | Enable or disable UPnP. |
| IGD Enable (UPnP Port Forward) | Enable or disable Internet Gateway Device (IGD). |
| IGD Configuration (External Port) | Select fully-automated or semi-automated IGD. |
| External HTTP Port | Enter an external HTTP port. |
| External RTSP Port | Enter an external RTSP port. |

IV-1-8. Bonjour

Bonjour is a feature of Mac computers which allows Safari web browser to discover devices and services on the local network and provide a quick shortcut for access. When enabled, Safari users on the local network can find a shortcut to the network camera under Safari's "Bonjour" menu. Select "Enable" or "Disable".

Bonjour

Enable Disable

Save settings

IV-2. Video

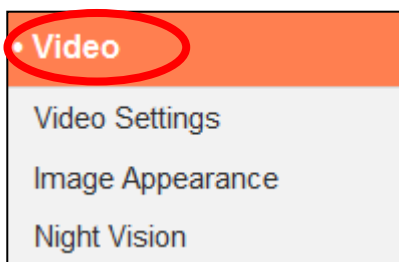

The “Video” menu consists of three categories for configuring the network camera’s video settings. Select an item from the submenu and refer to the appropriate following chapter.

IV-2-1. Video Settings

The “Video Settings” page enables you to modify the network camera’s resolution and frame rate settings.

Video Settings

| | |
|-------------------------|---|
| Format : | <input type="radio"/> H264 <input checked="" type="radio"/> MJPEG |
| H264 Resolution : | VGA (640 x 480) ▼ |
| H264 Maximum Bit Rate : | 2Mbps ▼ |
| MJPEG Resolution : | VGA (640 x 480) ▼ |
| MJPEG Quality : | High ▼ |
| Maximum Frame Rate : | 15 ▼ |
| Power Frequency : | 60 HZ ▼ |

| | |
|------------------------|---|
| Format | Select which format to use for your video, “H264” or “MJPEG”. |
| H264 Resolution | Select a H264 video resolution from the dropdown menu. A higher resolution provides more detailed video but requires more bandwidth. Note: Motion detection cannot be used when |

| | |
|------------------------------|---|
| | <i>“HD” resolution is selected.</i> |
| H264 Maximum Bit Rate | Select a maximum bit rate for H264 videos from the dropdown menu. A higher bit rate provides more detailed video but requires more bandwidth. |
| MJPEG Resolution | Select a MJPEG video resolution from the dropdown menu. A higher resolution provides more detailed video but requires more bandwidth. |
| MJPEG Quality | Select a quality level for MJPEG videos from the drop down menu. Higher quality requires more bandwidth. |
| Maximum Frame rate | Select the maximum video frame rate. A higher frame rate provides smoother video, but also requires more bandwidth. <i>Note: In dark environments, the network camera will automatically lower the frame rate to provide a better video quality, by using a longer exposure time.</i> |
| Power frequency | Adjust the power frequency to 50 Hz or 60 Hz frequency depending on your local region, in order to reduce flicker/improve playback in your videos. |

IV-2-2. Image Appearance

The “Image Appearance” page allows you to adjust various parameters relating to the network camera’s image appearance using the sliders shown below.

Image Appearance



| | |
|---|---|
| Brightness/ Contrast/ Saturation/ Sharpness/ | Click and drag the blue lever to change the value according to your preference for each category. |
| Reset to default | Click to reset all settings back to the default value of 50. |
| Save value | Save changes. |

IV-2-3. Night Vision

Night-vision allows your network camera to capture images in dark environments by using infra-red LEDs. Auto-switch will detect light levels in your network camera's environment and automatically switch to night-vision in low light. Select "Enable" or "Disable" for night-vision auto-switch.

Night Vision

Auto Switch : Enable Disable

IV-3. Events

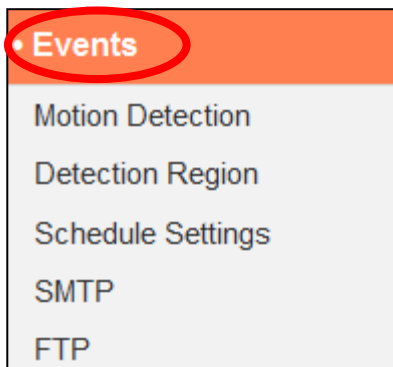

Select an item from the “Events” menu and refer to the appropriate following chapter. You can configure settings for motion detection, scheduling, SMTP and FTP.

IV-3-1. Motion Detection

The network camera features a motion detection function and various options for (motion detection) events notification. On this page you can enable or disable motion detection, event FTP upload and event emails as well as set the interval time to detect. Motion detection regions can be configured according to your preference on the “Detection Region” page (see next chapter).

Motion Detection

Motion Detection : Enable Disable
Interval Time To Detect :

FTP / Email Notification

Upload Event File to FTP : Enable Disable
Send Event File to Email : Enable Disable
Event File Format :
Video Recording Time :

| | |
|---------------------------------|---|
| Motion Detection | Enable or disable the motion detection function of your network camera. |
| Interval Time To Detect | After motion is detected, the network camera will not detect motion again for this length of time. For example, using an “Interval Time To Detect” of 20 seconds means that after motion is detected, the camera will not detect any further motion for 20 seconds. Then after 20 seconds, the camera will detect motion again. |
| Upload Event File to FTP | A snapshot image or short video of a detected event can be sent to a designated FTP server. Select “Enable” or “Disable” for this function. When enabled, you need to configure the FTP server information on the “FTP” page of the “Events” menu. |
| Send Event File to Email | A snapshot image or short video of a detected event can be sent to a designated email recipient. Select “Enable” or “Disable” for this function. When enabled, you need to configure the SMTP server information on the “SMTP” page of the “Events” menu. |
| Event File Format | Select a format for the event file which will be uploaded to FTP or sent to email. “JPEG” is a snapshot image while “H.264” is a video. |
| Video Recording Time | When H.264 (video) is selected as the event file format, specify the length of time for the video recording here. |

IV-3-2. Detection Region

When using the network camera's motion detection function, you can specify the area in the video where the network camera should be sensitive to motion. Motion outside of the detection region will be ignored by the network camera. This is useful to avoid false alarms.

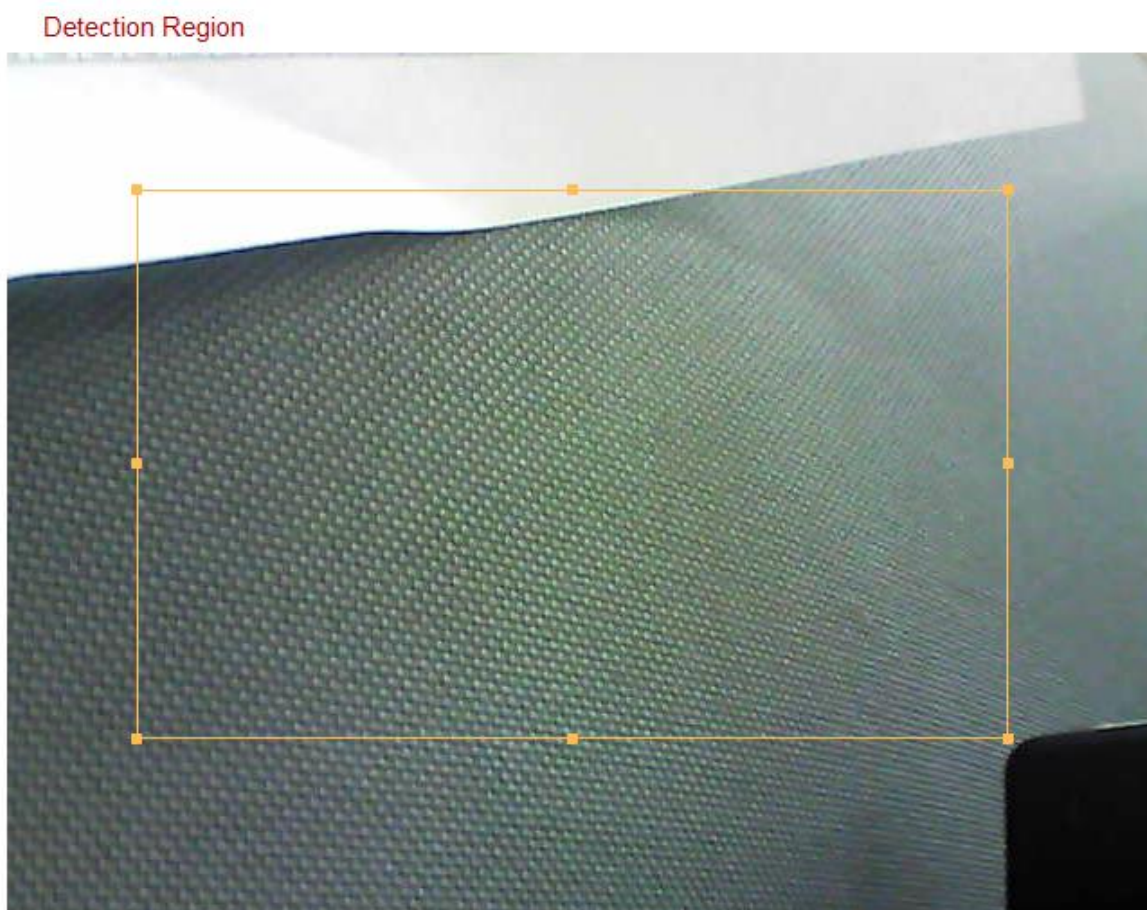

Region 1 **Region 2** **Region 3**

Sensitivity 90 90 90

Threshold 3 3 3

| Item | Description |
|---|---|
| Region 1 / Region 2 / Region 3 | Check the box to enable up to three motion detection regions. A color-coded rectangle will appear on the video view for each enabled region. Adjust the size and position |

| | |
|--------------------|--|
| | of each box according to your preference by clicking and dragging inside the box (move) or on the edges (resize). |
| Sensitivity | Adjust the sensitivity level of motion detection for each region. A higher value will trigger the alarm for minor motion in the video and vice-versa. You can reduce the sensitivity level if you receive unnecessary event notifications. |
| Threshold | Adjust the motion detection threshold level for each region. A higher value will trigger the alarm for large objects in the video, a lower value will trigger the alarm for smaller objects. |
| Save | Save your settings. |

IV-3-3. Schedule Settings

The network camera can be scheduled to record automatically at/on specified times and days. Select “Enable” to enable this feature and then define at which times the network camera will record using the table below.

For each day, click and drag across the timeline on the times which you want to record. A blue box indicates a scheduled recording. In the example below, recording is scheduled for 8am – 6pm Monday to Saturday.

Schedule Settings

Schedule : Enable Disable

| | 00:00 | 03:00 | 06:00 | 09:00 | 12:00 | 15:00 | 18:00 | 21:00 | 24:00 |
|-----------|---|-------|-------|-------|-------|-------|-------|-------|-------|
| Sunday | [Timeline: No recording scheduled] | | | | | | | | |
| Monday | [Timeline: Recording scheduled from 09:00 to 18:00] | | | | | | | | |
| Tuesday | [Timeline: Recording scheduled from 09:00 to 18:00] | | | | | | | | |
| Wednesday | [Timeline: Recording scheduled from 09:00 to 18:00] | | | | | | | | |
| Thursday | [Timeline: Recording scheduled from 09:00 to 18:00] | | | | | | | | |
| Friday | [Timeline: Recording scheduled from 09:00 to 18:00] | | | | | | | | |
| Saturday | [Timeline: Recording scheduled from 09:00 to 18:00] | | | | | | | | |

Buttons: Delete, Delete all, Select all, Store

Start : 08 : 00
End : 18 : 00

| | |
|-------------------|---|
| Delete | Delete the selected blue recording block on the timeline. |
| Delete All | Delete all blue recording blocks on the timeline. |
| Select All | Select all blue recording blocks. |
| Store | Store the recording settings on the timeline. Note: Schedule settings must also be enabled for the schedule to come into effect. |

IV-3-4. SMTP

A snapshot image of a motion-detected event can be sent to a designated email recipient. This function must be enabled in “Motion Detection” settings in the “Events” menu. Enter the required information about your sender and recipient email accounts below.

SMTP

Email Service Provider:

SMTP Server:

SMTP Port:

Recipient Email Address:

Sender Email Address:

SSL/TLS:

SMTP Authentication: Enable Disable

Account:

Password:

| | |
|-------------------------------|--|
| Email Service Provider | Select “Manual Settings” to enter the information manually or select a common email provider to enter some of the information automatically. |
| SMTP Server | Input the host name or IP address of the SMTP server for the email sender. This information can be provided by your email service provider. |
| SMTP Port | Input the SMTP port number for the email sender. Most SMTP servers use port number 25, while some SMTP servers use encrypted connections with a port number of 465. This information can be provided by your email |

| | |
|---------------------------------|---|
| | service provider. |
| Recipient E-Mail Address | Enter the email recipient's email address here. |
| Sender E-Mail Address | Enter the sender's email address here to avoid spam filter issues. |
| SSL/TLS | Select 'SSL or TLS' when your SMTP server requires encryption. Consult your mail server administrator when in doubt. |
| SMTP Authentication | Select 'Enable' when your SMTP server requires authentication. This information can be provided by your email service provider. |
| Account | Input the SMTP account name when your SMTP server requires authentication. This information can be provided by your email service provider. |
| Password | Input the password used for SMTP server authentication. |
| Send Test Email | Click here to send a test email with the current settings. |

IV-3-5. FTP

A snapshot image of a detected event can be sent to a designated FTP server. This function must be enabled in “Motion Detection” settings in the “Events” menu. Enter the required information about your FTP server below.

FTP

FTP Server:

Username:

Password:

Port:

Path:

Passive mode: Enable Disable

| | |
|---------------------|--|
| FTP Server | Enter the IP address or host name of the FTP server. |
| User Name | Enter the user name required by the FTP server. |
| Password | Enter the password of the FTP server. |
| Port | Enter the port number of the FTP server. This value should be an integer between 1 and 65535. Please don't change this value unless advised by the FTP server's administrator. |
| Path | Enter a path (folder) to save files on the FTP server. If blank, files will be saved in the FTP server's default root folder. |
| Passive mode | Enable or disable passive mode according to your FTP server. |

IV-4. System

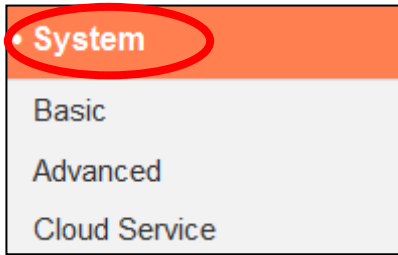

The “System” menu consists of three categories, “Basic”, “Advanced” and “Cloud Service”. Select a category and follow the appropriate chapter for more information.

IV-4-1. Basic

The “Basic” menu enables you to set the camera’s name and administrator password, as well as switch the LED(s) on/off according to your preference.

Basic

Network Camera Name:

Administrator Password:

Confirm Password:

LED Indicators: On Off

| | |
|-------------------------------|--|
| Network Camera Name | Set the name of the network camera for reference/identification purposes. This is especially useful when managing multiple network cameras. |
| Administrator Password | Enter your desired administrator password here. This is the password used to log into the camera with the “admin” account. |
| Confirm Password | Confirm your desired administrator password here. |
| LED Indication | Select “On” or “Off” to switch the network camera’s LED(s) on or off. Switching off the LEDs can be a power saving measure or can be for security purposes, so that anybody who can see the network camera is unaware if the camera is active. |

IV-4-2. Advanced

The “Advanced” page allows you to upgrade the network camera’s firmware, backup or restore the network camera’s settings, and reset or restart the network camera. Please check the Edimax website for the latest firmware for your network camera.



Do not switch off or disconnect the device during a firmware upgrade, as this could damage the device.

Upgrade Firmware

Firmware Filename:

Backup/Restore Settings

Backup Settings:

Restore Settings:

Reset

Restart:

Reset to Default: Keep Network Settings Default Settings

| | |
|--------------------------|---|
| Firmware Filename | Click “Browse” to locate the firmware file on your computer. |
| Upgrade Firmware | Click to upgrade the firmware to your selected file. |
| Backup Settings | Click “Apply” to save the current settings on your computer as config.bin file. |
| Restore Settings | Click “Browse” to find a previously saved config.bin file and then click “Upload” to replace your current settings. |
| Restart | Click “Restart Network Camera” to restart the network camera. Please wait a couple of minutes for network camera to boot up after a restart. Restarting will not affect the camera’s current configuration. |

| | |
|-------------------------|---|
| Reset to default | <p>Select “Keep Network Settings” or “Default Settings” and then click “Reset to Default”.</p> <p>When the camera resets, “Keep Network Settings” will reset all settings but keep the current network settings. The network camera’s IP address will remain the same.</p> <p>“Default Settings” will reset all of the camera’s settings, including network settings, back to the factory default status.</p> |
|-------------------------|---|

IV-4-3. Cloud Service

Edimax Plug & View is a function to allow you to view your network camera remotely via a cloud server (see **V. Myedimax.com**). You can enable or disable this feature here.

Plug & View

Enable Disable

IV-5. Status

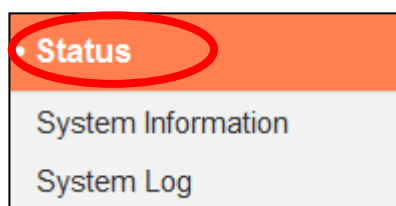

The “Status” menu provides important information about the status of the network camera. This information is useful for troubleshooting purposes or for network configuration.

IV-5-1. System Information

A summary of system-wide information about the network camera is displayed on this page, displayed under four categories: System, LAN, Wireless LAN and IGD (UPnP Port Forward).

System

| | |
|--------------------|------------------------------|
| Firmware Version : | v1.03 (Oct 11 2013 18:08:59) |
| Activex Version : | v1.0.0.28 |
| Device Uptime : | 38 min 47 sec |
| System Time : | 2013/10/18 03:57:53 |

LAN

| | |
|----------------|-------------------|
| IP Address : | 192.168.10.154 |
| Subnet Mask : | 255.255.255.0 |
| Gateway : | 192.168.10.1 |
| DNS Server 1 : | 192.168.10.1 |
| DNS Server 2 : | 192.168.10.1 |
| MAC Address : | 00:11:09:01:02:04 |
| HTTP Port : | 80 |

Wireless LAN

Link Status : Connected
SSID : edimax.setup
Channel : 2
Encryption : WPA2 PSKAES
Access Point MAC Address : 00:E0:4C:81:96:C1

IGD (UPnP Port Forward)

Link Status : Can not find device with UPNP IGD support
External IP Address :
External HTTP Port :
External RTSP Port :

IV-5-2. System Log

A system log provides information about the network camera's usage and actions. The system log can also be sent to a remote server for archiving.

System Log

Log Level:

Remote Log: Enable Disable

Remote Log Server:

```
Jan 1 00:00:20 syslogd started: BusyBox v1.13.4
Jan 1 00:00:20 kernel: klogd started: BusyBox v1.13.4 (2013-09-25 01:20:53 CST)
Jan 1 00:00:20 kernel: pcam"
Jan 1 00:00:20 kernel: 0x000000780000-0x000000800000 : "jffs2"
Jan 1 00:00:20 kernel: ehci_hcd: USB 2.0 'Enhanced' Host Controller (EHCI) Driver
Jan 1 00:00:20 kernel: b8021000=10000001
Jan 1 00:00:20 kernel: b8021054=200000
Jan 1 00:00:20 kernel: reg e0=99
Jan 1 00:00:20 kernel: reg e1=ac
Jan 1 00:00:20 kernel: reg e2=98
Jan 1 00:00:20 kernel: reg e3=c1
Jan 1 00:00:20 kernel: reg e4=1
Jan 1 00:00:20 IPCam[1029]: *** IPCam main program started. ***
Jan 1 00:00:20 IPCam[1029]: Init random number generator...
Jan 1 00:00:20 IPCam[1029]: Init random number generator with value: 76432496
Jan 1 00:00:20 IPCam[1029]: Init gpio function...
Jan 1 00:00:20 IPCam[1029]: Init networking...
Jan 1 00:00:20 kernel: DWC_otg: Init: Port Power? op_state=1
Jan 1 00:00:20 kernel: DWC_otg: Init: Power Port (0)
Jan 1 00:00:20 kernel: usb usb3: configuration #1 chosen from 1 choice
Jan 1 00:00:20 kernel: usb 1-1: new high speed USB device using rtl8652-ehci and address 2
```

| | |
|--------------------------|---|
| Log Level | Select a level of detail for the log from the dropdown list, from 0 - 4. 0 (minimum) will only log critical information, while 4 (maximum) will log everything. |
| Remote Log | Enable or disable the network camera's remote log function, to send the log to a remote server for archiving. The network camera supports syslog log servers. |
| Remote Log Server | Enter the IP address or host name of the log server you wish to use. |

V. Myedimax.com

You can use your network camera's Myedimax.com cloud ID to monitor your camera remotely using a web browser from any Internet connection. The network camera's **green** LED must display **on** to indicate a successful cloud connection, in order for this function to work.

1. Identify your network camera's cloud ID. The cloud ID is displayed in EdiView Finder (see III-1.) and on the product label on the back of the network camera (see I-5.).

 **The cloud ID is a string of 12 characters consisting of numbers 0 – 9 and letters A – F which is unique to your network camera.**

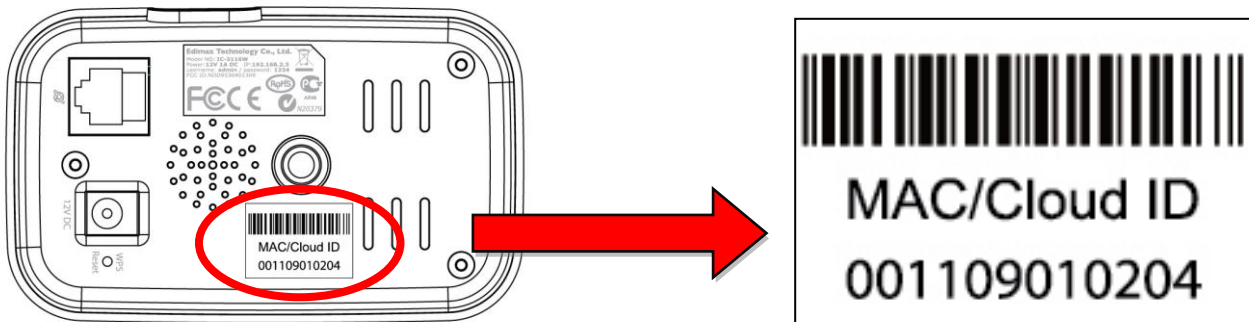

2. Enter **cloudID.myedimax.com** into the URL bar of a web browser.

For example, if your cloud ID is **001109010204** then enter **001109010204.myedimax.com** into your web browser.

 **Internet Explorer is recommended.**



3. You may be prompted to allow a Java add-on to run. Please click the message where it says "click here" and then click "Run Add-on".

. If you trust the website and the add-on and want to allow it to run, click here...

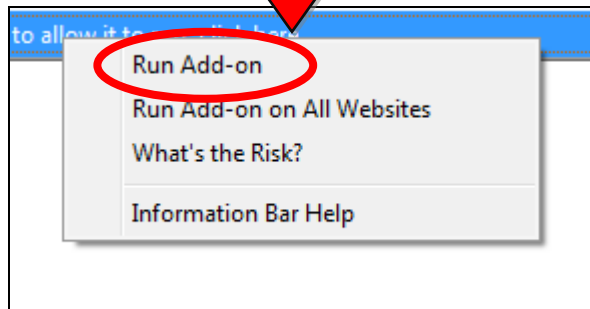

If any other security warnings/prompts appear, please select “Run” or “Allow” or similar, depending on your browser.

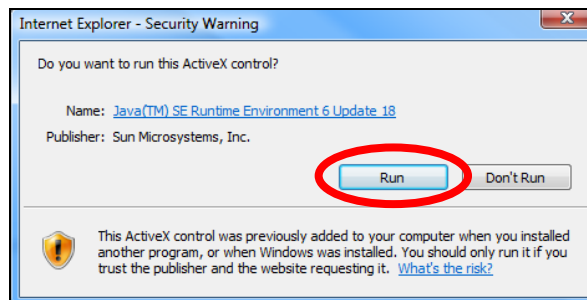

4. Enter your camera's password (default password: 1234) and click “OK” to see a live stream from your network camera.

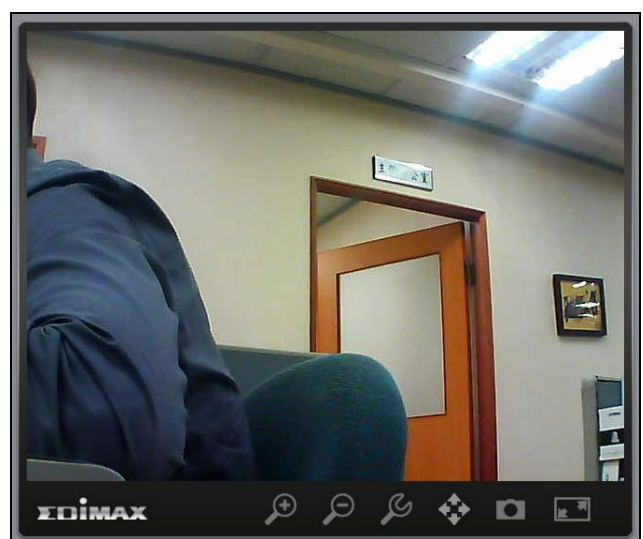
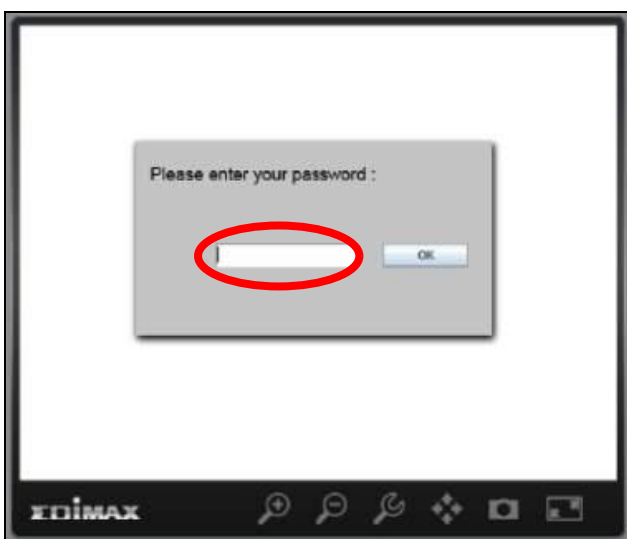

- 5.** The network camera can be operated and configured using the icons in the toolbar located below the image.

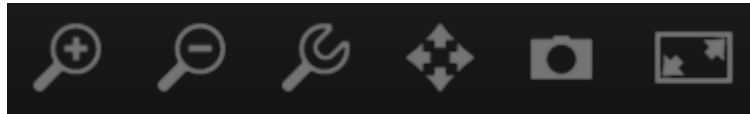

To configure the network camera, click  to show the configuration menu window:

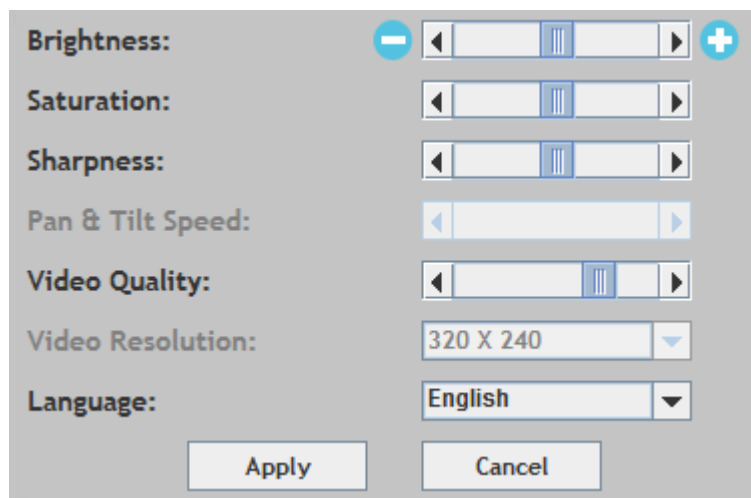

- 6.** Use the slider controls to change the image brightness, saturation, sharpness, video quality and pan & tilt speed. Use the dropdown lists to change the video resolution and operating language, and click “Apply” when finished.

VI. 16 Channel Viewer for Windows

The included 16 channel viewing software provides powerful access to your network camera's functions, along with the capability to view and manage up to 16 network camera simultaneously.

VI-1. Installation

1. Insert the included CD into your CD-ROM drive and if the setup utility does not automatically open, please locate and open the "Autorun.exe" file in the "Autorun" folder.
2. Click "16 Channel Viewer" to install the EdiView Finder software utility.

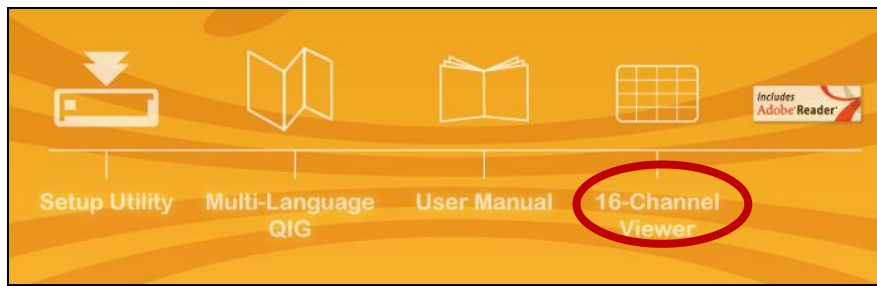

3. Click "Next" and follow the on-screen instructions to install the 16 channel viewer software.

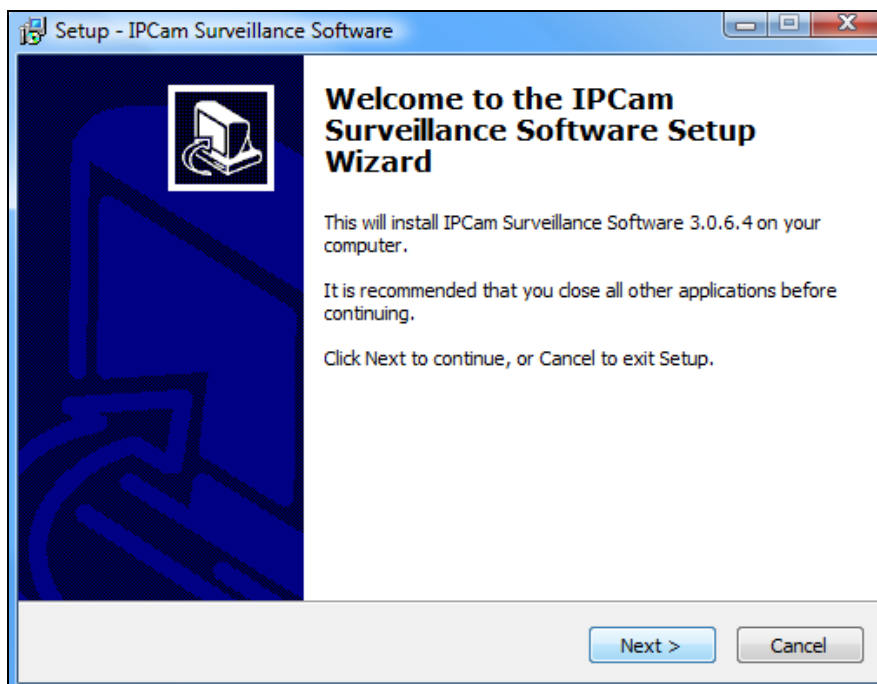

4. Check the installation location and click 'Next' to continue.

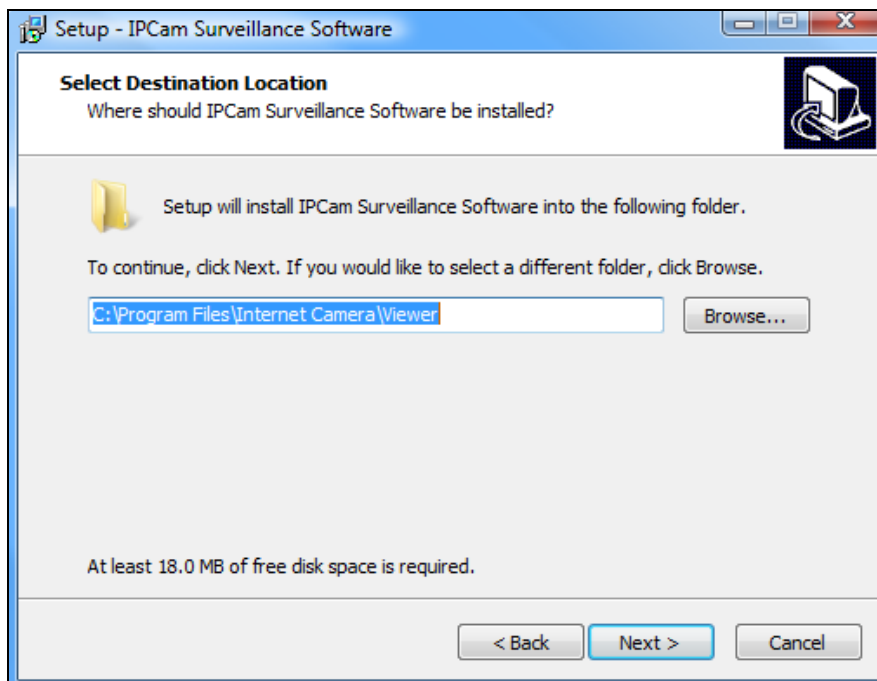

5. Click "Next" to continue.

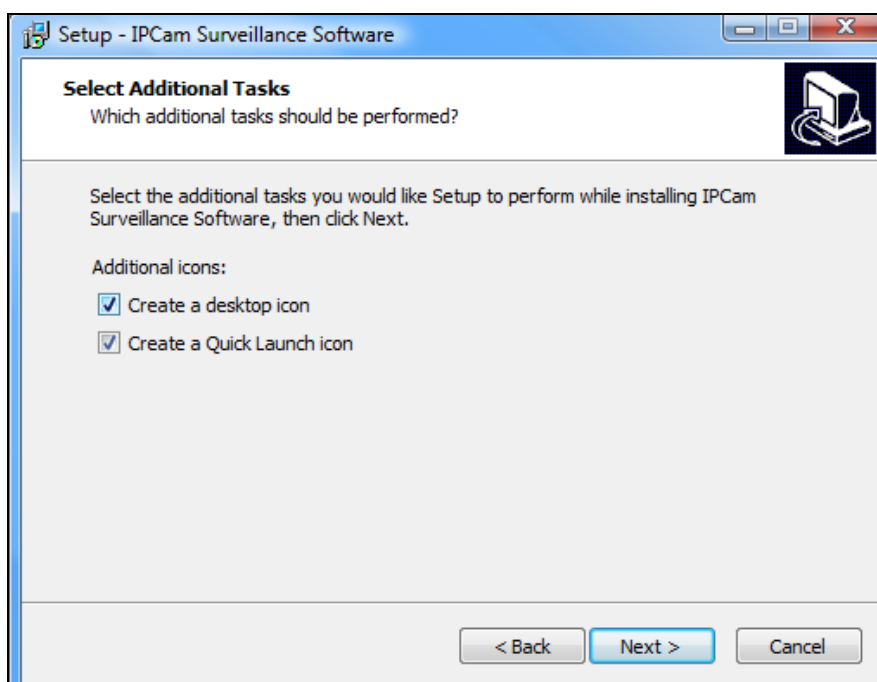

6. A summary of your installation will be displayed. Please check everything is correct and click "Install" to begin the installation.

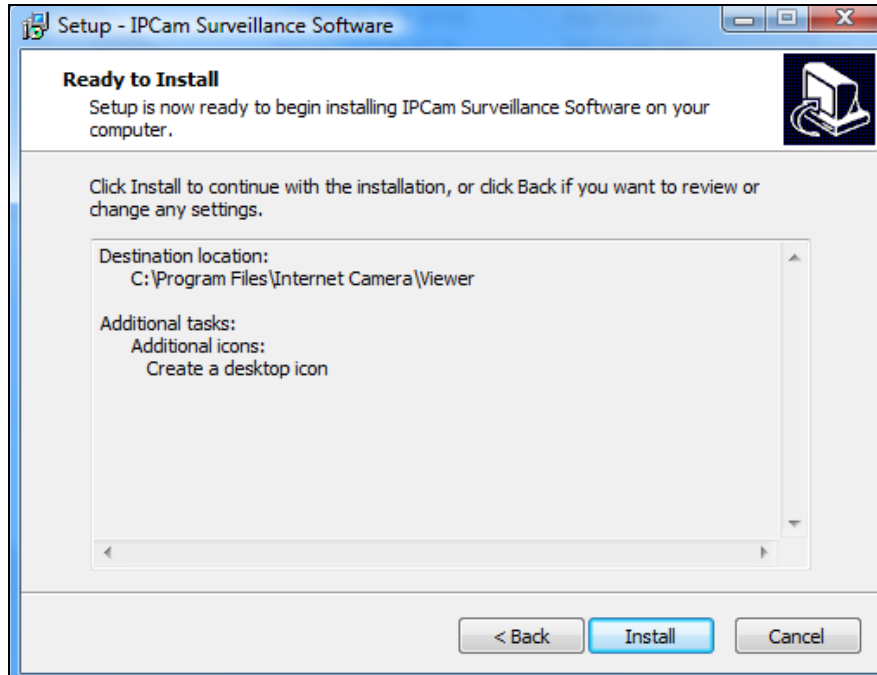

7. Please wait a moment for the installation to complete.

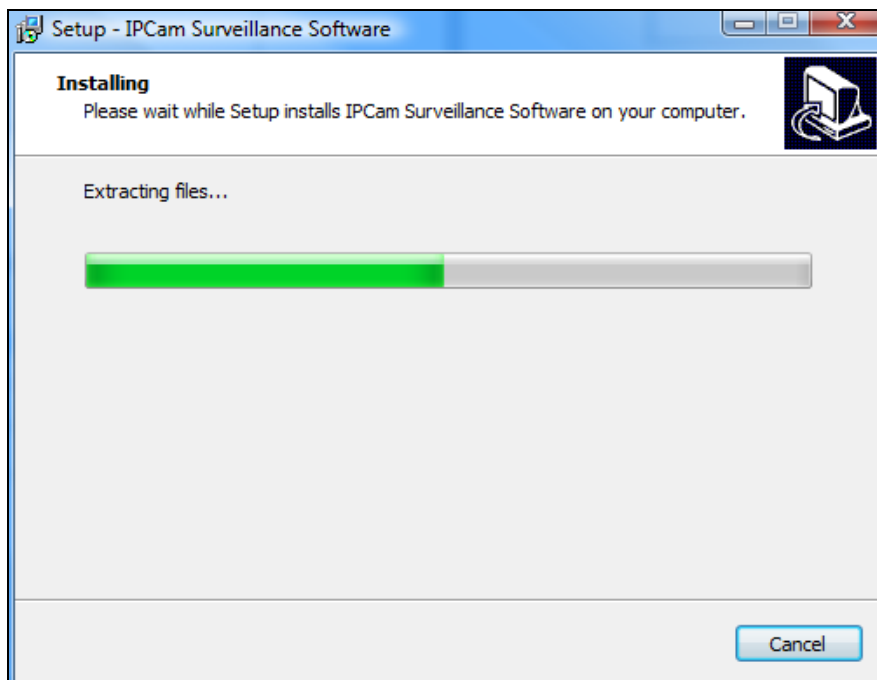

8. Click “Finish” and then double click the “IPCam Surveillance Software” icon on your desktop to open the software.

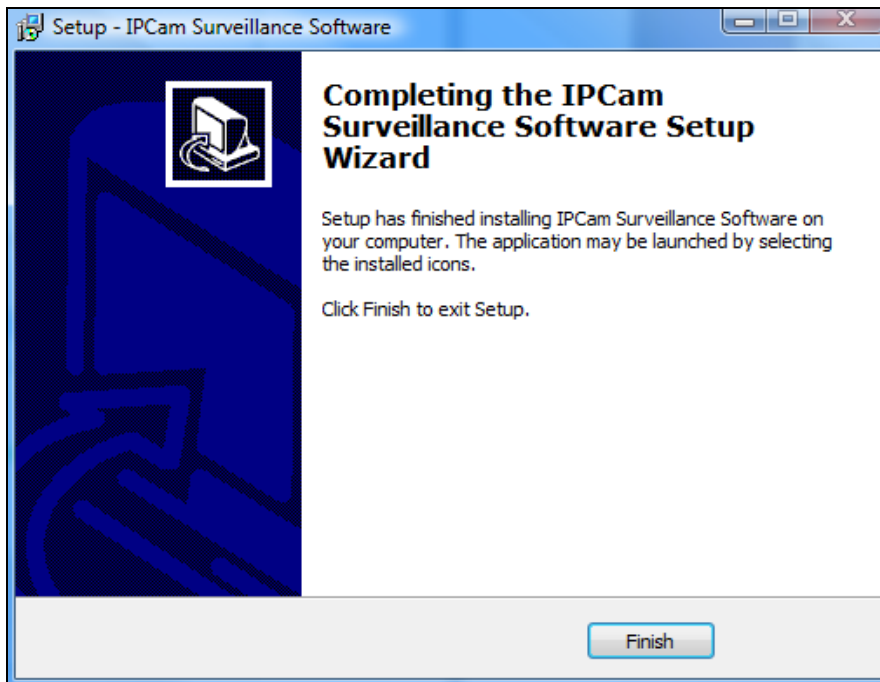







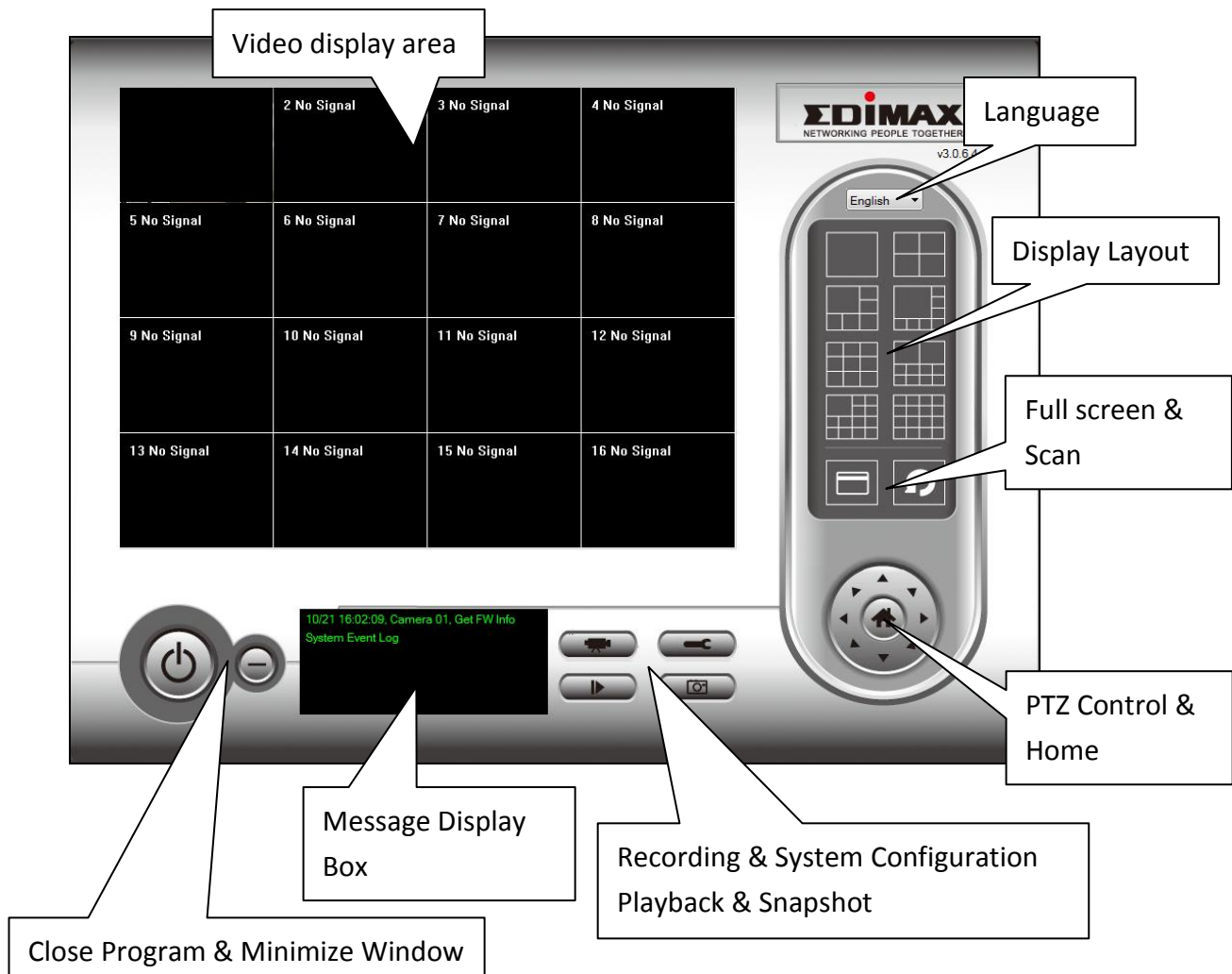



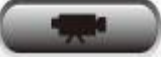

VI-2. Using the 16 Channel Viewer

 **Your monitor's resolution must be "1024 x 768" for the 16 channel viewer to work properly. Please set your monitor's resolution to "1024 x 768".**

The main screen of the 16 channel viewer is described below:



| | |
|--|---|
| Video display area | A live image of up to 16 connected cameras will be displayed in this area. |
| Language | Select a language from this dropdown menu to change the display language. |
| Display layout  | Change camera image display layout (click a layout icon to change camera display layout). There are 8 kinds of display layouts available. |
| Full screen  | Click this button to switch to full screen mode (only display all camera's image), press "ESC" key to quit full screen mode. |
| Scan  | Click this button and the network camera surveillance software will switch through the images of all connected camera automatically. Click this button once to activate the scan function (scan icon will become blue ) , click again to stop scanning (scan icon will become white ). |
| PTZ control  | There are 8 directions in the Pan Tilt Zoom (PTZ) control ring. If the camera you connect to supports PTZ, you can use the PTZ control ring to change the direction that the camera faces. This function is only available for supported cameras. |
| Home  | Click this button to return the camera to "Home" (default) position. This function is only available for supported cameras. |
| Recording  | Start video recording. |
| System Configuration  | Camera configuration and general options. |
| Playback  | Play back a recorded video file. A new window will open to locate recorded files. |
| Snapshot | Take a snapshot of current the camera image. |

| | |
|--|--|
|  | |
| Message display | Displays all system messages. |
| Close window (stop surveillance)  | Terminates network camera surveillance software. |
| Minimize window  | Minimizes network camera surveillance software window. |

VI-3. Configuring the 16 Channel Viewer

VI-3-1. Add Camera/Camera Configuration

In order to use the 16 channel viewer software, you must configure/add each camera(s) that you wish to connect. Please click the wrench icon () and a popup menu will appear:

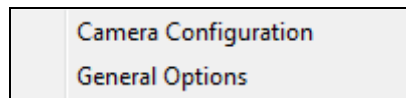

Please select “Camera Configuration” to configure/add cameras:

 ***Please select “Unblock” if you are prompted by Windows Security Alert that “IPCamViewer” has been blocked, or similar.***



VI-3-1-1. Camera

In the “Camera Configuration” tab you can add and configure all the cameras you wish to connect to the viewer software. To connect a camera to the viewer software, you need to enter the required information in the “Camera Configuration” box. You can do this automatically by selecting your camera listed in the “Camera Search” box and clicking “Select” (recommended) or you can enter the information manually.

The screenshot shows the 'Camera Configuration' window with the following elements:

- Channel List:** A list of channels from Channel 1 to Channel 16, with Channel 1 selected.
- Configuration Tabs:** 'Camera', 'Scheduled Recording', 'Audio', and 'Motion-Triggered Recording'. The 'Camera' tab is active.
- Camera Configuration 1:**
 - Name: IC-010204
 - Model: Edimax_IC3116W
 - IP Address: 192.168.10.154
 - Username: admin
 - Web Port: 80
 - Password: (masked with dots)
 - Video Format: M-JPEG
 - Buttons: Reset
- Camera Search:**
 - Table with columns: Camera Name, IP, Model.
 - Row 1: IC-010204, 192.168.10.154, Edimax_IC3116W (highlighted).
 - Buttons: Select, Refresh.
- Bottom Buttons:** OK, Cancel.



All of the information required to add your network camera can be completed automatically by selecting your camera listed in the “Camera Search” box and clicking “Select”.

| | |
|----------------------|--|
| Channel | Select the channel number you wish to use. |
| Camera Search | All cameras found on your local network will be displayed in the “Camera Search” box. |
| Select | Select a camera listed in the “Camera Search” box, and click the “Select” button to automatically enter the required information to connect the selected camera in the “Camera Configuration” box. |

| | |
|-----------------------|--|
| Refresh | Rescan the list of cameras on your local network. |
| Name | Enter the name of the camera here. The default name is the first 6 bytes of the camera's MAC address; you can change the name of the camera so you can remember the camera's location or purpose easily. |
| Model | Displays the model of the selected camera, this field cannot be changed. |
| IP Address | Input the IP address of the camera. |
| Username | Input the user name of the camera. |
| Web Port | Input the web port of the camera. By default it's "80". |
| Password | Input the password of the camera. Default password is "1234". You should change the entered password if you changed the password of the selected camera. |
| Video Format** | Select the video encoding format of this camera (MJPEG or H.264). |
| Reset | Clear all fields in the 'Camera Configuration' section. |
| OK | Save settings. |
| Cancel | Discard all settings in this tab. |

** : Only available for cameras support this function.

Click "OK" to save the settings and your network camera's image will be displayed in your selected channel on the 16 channel viewer's main screen:

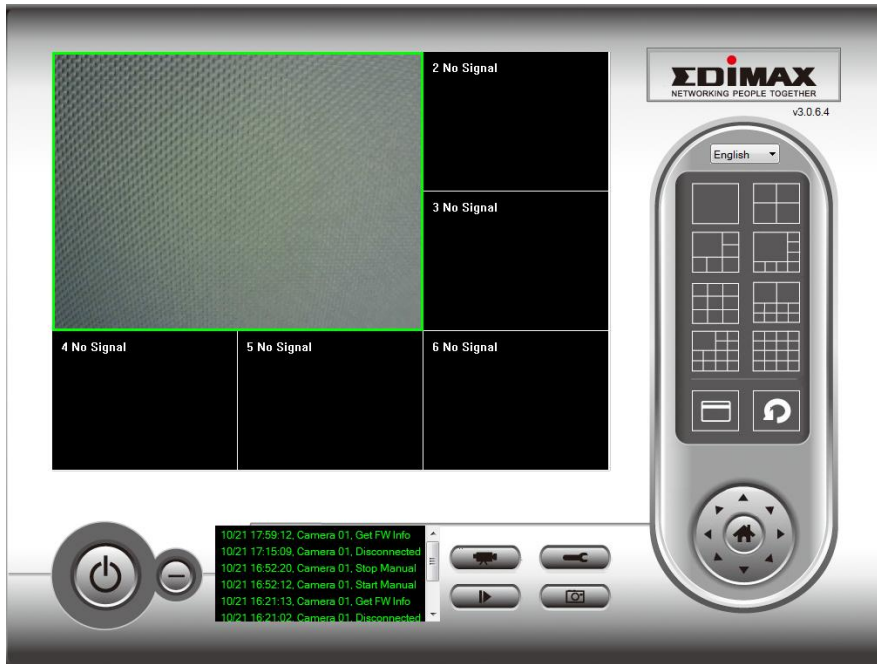

VI-3-1-2. Scheduled Recording

In this tab, you can setup scheduled video recording, so you can record the video captured by all cameras you have according to a pre-defined schedule.

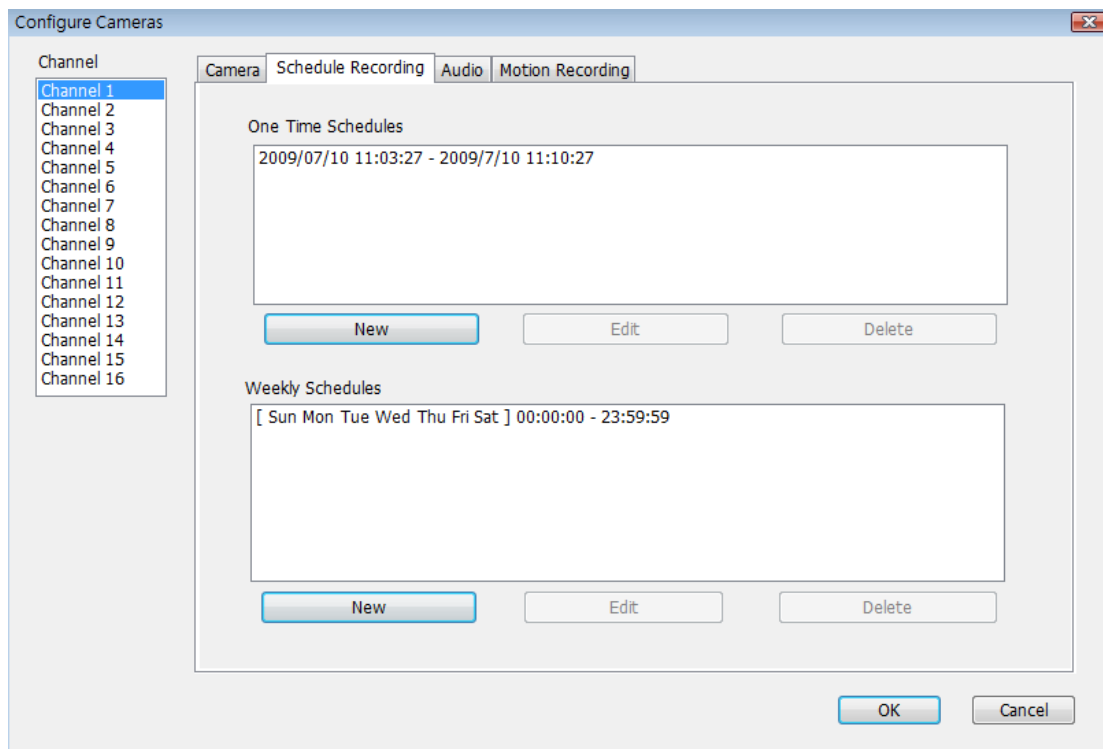

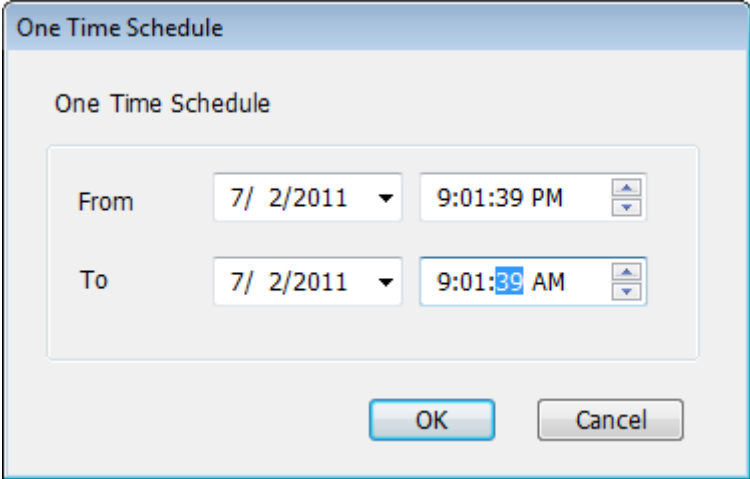
| | |
|---------------------------------|--|
| Channel | Select the channel number you wish to set. |
| One Time Schedules | You can specify the one-time schedule for a selected camera; this schedule will be executed once only. |
| New (One Time Schedules) | <p>Click this button and a new window will appear:</p>  <p>Please specify the time duration of this one-time schedule (the date and time of 'From' and 'To'), then click 'OK' to save settings.</p> <p>Please note you must set a schedule that will happen in the future, you cannot set a schedule in the past.</p> |
| Edit | You can modify a scheduled recording item. Select a schedule in 'One Time Schedules' list, and click the 'Edit' button to edit the start and end time of this schedule. |
| Delete | Delete a selected schedule item. |
| New (Weekly Schedules) | Click this button and a new window will appear: |

You can define the recording schedule that will be executed at the specified time of certain weekday(s) in a week. Please check all weekdays that apply, and set the start time in the 'From' field. You can set the duration of video recording in the 'Period' field (format is HH:MM:SS), and the end time will be calculated automatically and displayed in the 'To' field. You can also click the 'All Time Record' button to define a recording schedule that will be executed every weekday, from 12:00:00AM to 11:59:59PM.

Click 'OK' to save changes.

| | |
|---------------|---|
| Edit | You can modify a scheduled recording item. Select a schedule in the 'One Time Schedules' list, and click the 'Edit' button to edit the start and end time of this schedule. |
| Delete | Delete a selected schedule item. |
| OK | Save settings. |
| Cancel | Discard all settings in this tab. |

VI-3-1-3. Audio

For cameras that support audio, you can use this tab to decide if you wish to hear the audio captured by the selected camera.

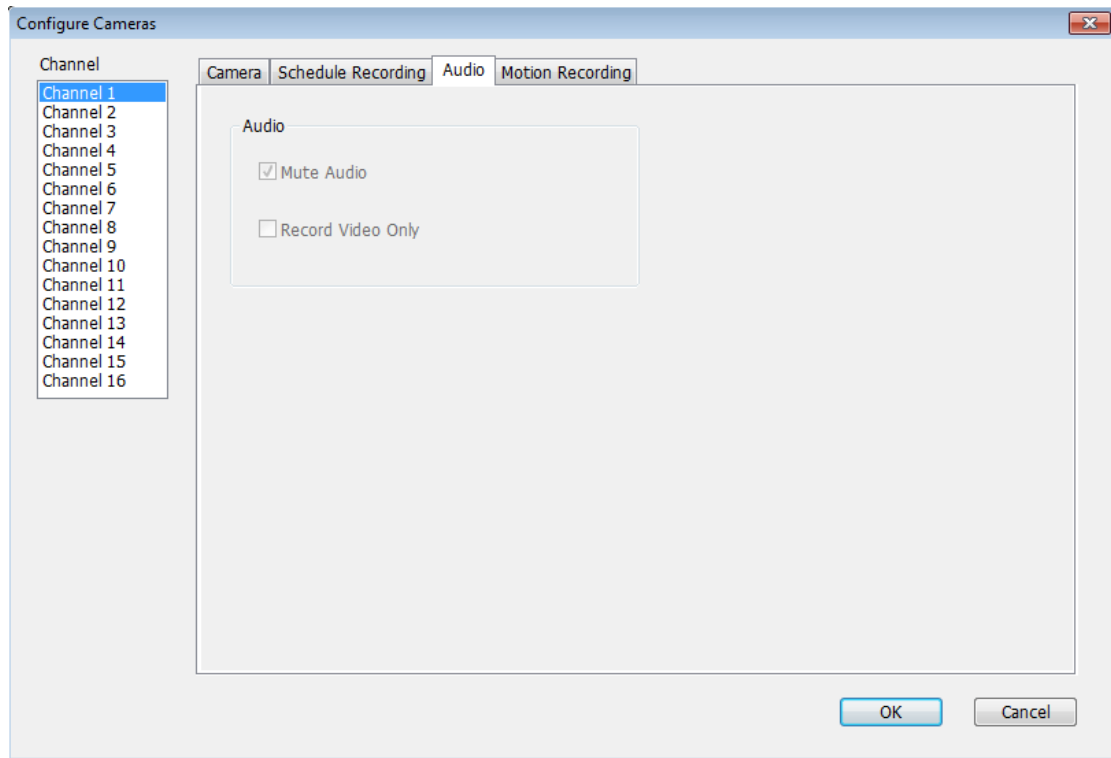

| | |
|--------------------------|--|
| Channel | Select the channel number you wish to set. |
| Mute Audio | Check this box and the network camera surveillance software will not play the audio captured by this camera. |
| Record Video Only | Check this box and the network camera surveillance software will not record the audio captured by this camera. |
| OK | Save settings in this tab. |
| Cancel | Discard all settings in this tab. |

VI-3-1-4. Motion Recording

The network camera features a motion detection function and various options for (motion detection) events notification. On this page you can enable or disable motion detection and set the camera to send an email or trigger an alarm when motion is detected.



Please not that when using the camera for security purposes, it is important to monitor the camera's stream even when using motion detection. Motion detection may not be 100% accurate.

Camera Configuration

Channel

- Channel 1
- Channel 2
- Channel 3
- Channel 4
- Channel 5
- Channel 6
- Channel 7
- Channel 8
- Channel 9
- Channel 10
- Channel 11
- Channel 12
- Channel 13
- Channel 14
- Channel 15
- Channel 16

Camera | Scheduled Recording | Audio | Motion-Triggered Recording

Motion-Triggered Recording

Enable Disable

Video Length: 10 seconds

Invoke alarm when motion is detected

Send email when motion is detected

OK Cancel

| | |
|--|---|
| Channel | Select the channel number you wish to set. |
| Enable | Enable motion record function. |
| Disable | Disable motion record function. |
| Video Length | Select the time duration from the dropdown menu, in seconds, that the camera will record when a motion has been detected. |
| Invoke alarm when motion is triggered | Send an alarm when a motion has been detected by the camera. |
| Send mail when | Send an email to a pre-defined address when |

| | |
|----------------------------|---|
| motion is triggered | a motion has been detected by the camera. |
| OK | Save settings in this tab. |
| Cancel | Discard all settings in this tab. |

VI-3-2. General Options

Click the wrench icon() and a popup menu will appear:

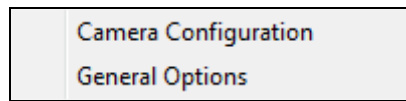

When you select “General Options”, please refer to the appropriate following chapter:

VI-3-2-1. General

All general settings such as the file storage directory and recording spaces can be set here.

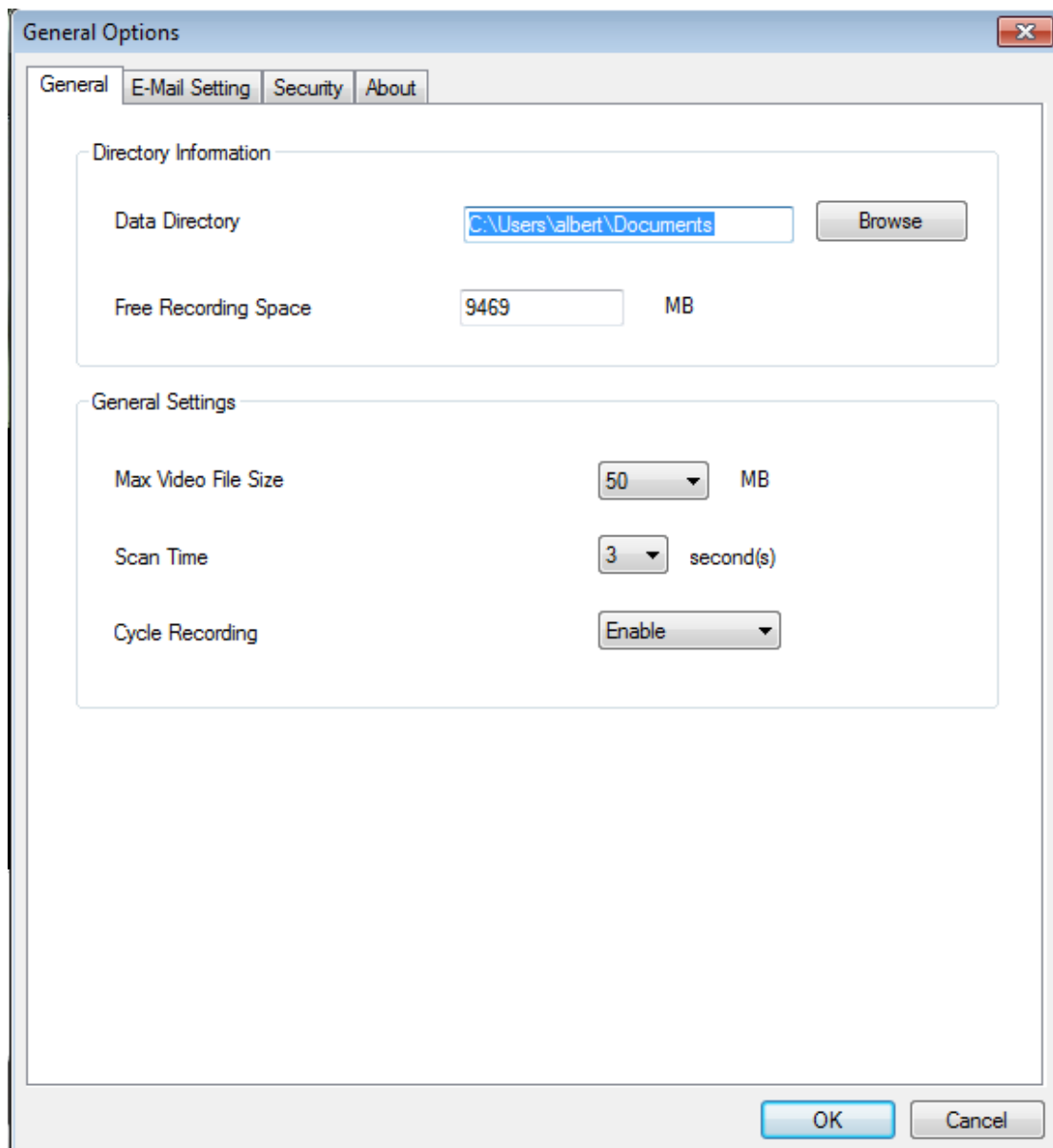

| | |
|-----------------------------|---|
| Data Directory | Set the directory (folder) you wish to store the recorded video and captured image. You can click the 'Browse' button to pick a directory on your hard disk. |
| Free Recording Space | Displays remaining storage space. |
| Max Video File Size | Defines the maximum file size of every video file. When the size of the file exceeds this value, the network camera surveillance software will open another file to record the video. |
| Scan Time | Define the time period to pause between every camera switch when you activate the 'Scan' function. |
| Cycle Recording | You can decide the behavior when hard disk space is full: Disable: Do not overwrite recorded video files. Enable: Overwrite recorded video files. |
| OK | Save settings in this tab. |
| Cancel | Discard all settings in this tab. |

VI-3-2-2. Email Setting

If you want to use the motion detection function and wish to receive an email that contains the image captured by the camera, please set up your email related parameters here first.

The screenshot shows a window titled "General Options" with a close button in the top right corner. It has four tabs: "General", "E-Mail Setting", "Security", and "About". The "E-Mail Setting" tab is active. The form contains the following elements:

- E-Mail Subject:** A text input field.
- Recipient E-Mail Address:** A large text area for listing email addresses, with three buttons below it: "New", "Edit", and "Delete".
- Sender E-Mail Address:** A text input field.
- SMTP Server:** A text input field.
- SMTP Port:** A text input field containing the number "25".
- SMTP Auth:** Two radio buttons labeled "Enable" and "Disable". The "Disable" radio button is selected.
- SMTP Account:** A text input field.
- SMTP Password:** A text input field.
- Buttons:** "OK" and "Cancel" buttons are located at the bottom right of the dialog.

| | |
|---------------------------------|--|
| E-Mail Subject | Specify the subject of the sent email. |
| Recipient E-Mail Address | Lists all email addresses you set. |
| New | Click this button and you'll be prompted to input the email address. Click 'OK' to save changes. |

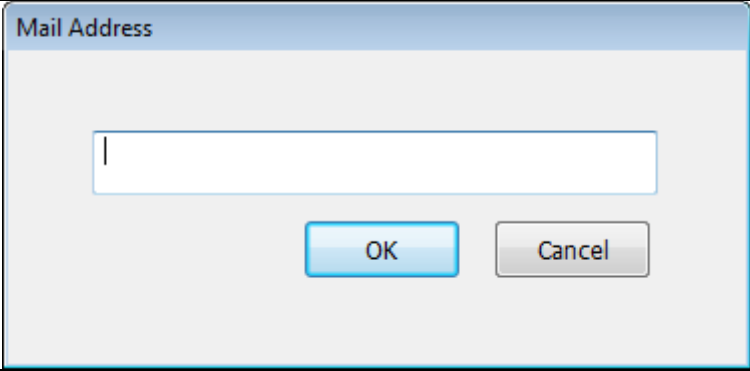
| | |
|------------------------------|--|
| |  |
| Edit | Select an email address from the 'Recipient E-Mail Address' box, and click 'Edit' to edit the email address. |
| Delete | Delete the selected email address. |
| Sender E-Mail Address | Specify the email address that will appear as the sender. |
| SMTP Server | Specify the IP address or host name of the SMTP server you wish to use. Most ISPs will only allow their subscribers to use their SMTP server, if you don't know which SMTP server you should use, please refer to the settings in your email software or ask your ISP / network administrator. |
| SMTP port | Specify the port number of the SMTP server you wish to use here. By default (and the setting of most of SMTP servers) it's '25'. |
| SMTP Auth | Select 'Enable' if your SMTP server requires authentication, select 'Disable' if it's not required. If you don't know if your SMTP server requires authentication, please refer to the settings in your email software or ask your ISP / network administrator. |
| SMTP Account | Input the SMTP account (username) of your SMTP server here. In most cases, it's the same as your POP3 username (the one you use to receive email). Please refer to the settings in your email software or ask your ISP / network administrator if you're not sure about this. |
| SMTP Password | Input the SMTP password of your SMTP server here. In most cases, it's the same as |

| | |
|---------------|---|
| | your POP3 password (the one you use to receive email). Please refer to the settings in your email software or ask your ISP / network administrator if you're not sure about this. |
| OK | Save settings in this tab. |
| Cancel | Discard all settings in this tab. |

VI-3-2-3. Security

You'll need to input the password every time you wish to use this network camera surveillance software:

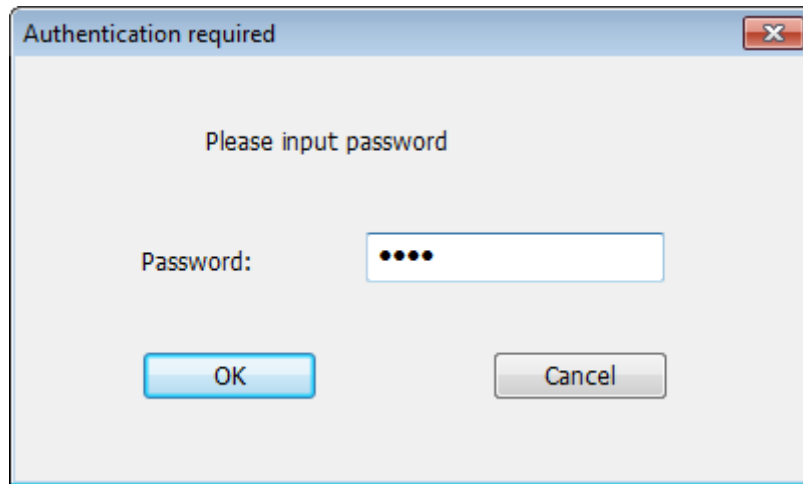

To set the password, please use the 'Security' tab in the 'General Options' menu:

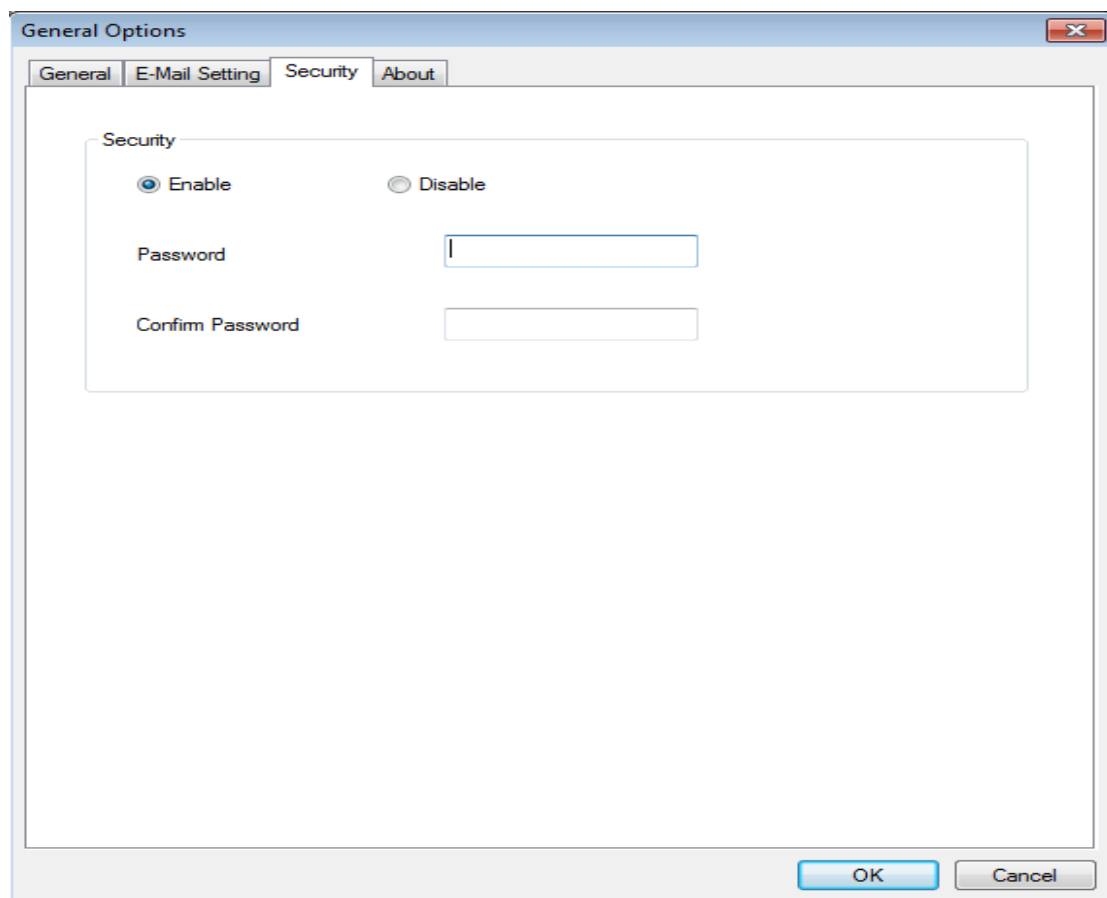

Here are the descriptions of all settings:

| | |
|-------------------------|--|
| Enable | Requires password authentication when this software starts. |
| Disable | Password authentication is not required when this software starts. |
| Password | Input the password you wish to use here. |
| Confirm Password | Input the password you wish to use here again. |

VI-3-2-4. About

Software version is displayed in this tab.

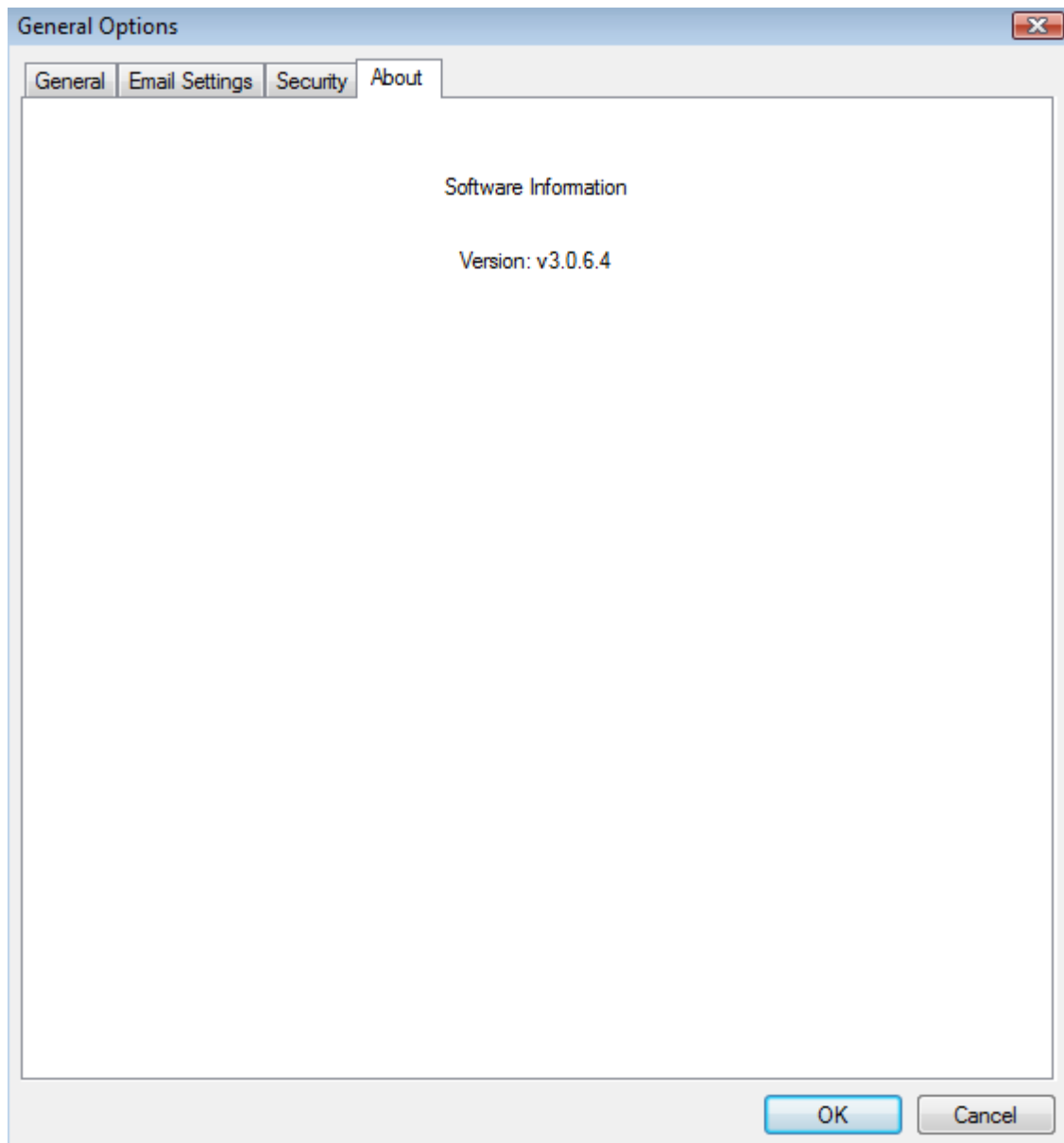

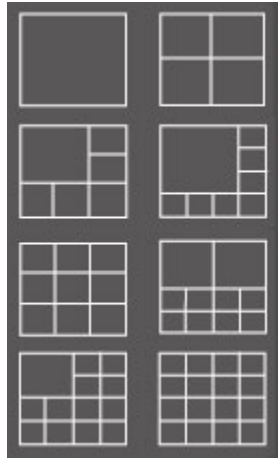

VI-4. Changing the Display Layout

This network camera surveillance software provides 8 display layouts:

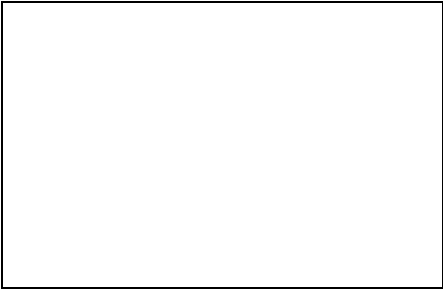

Every layout displays a different number of cameras in different arrangements, you can click the icon that represents a specific layout, and the video display area will change accordingly.

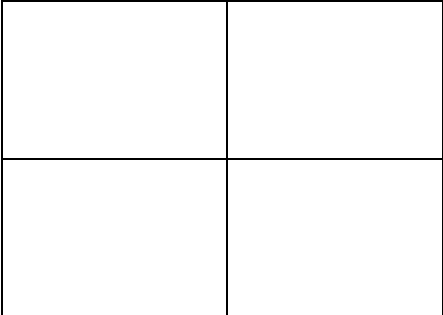
| | |
|---|--|
| <p>Layout style 1: 1 Camera only</p>  | <p>Displays the video of 1 camera only.</p>  |
| <p>Layout style 2: 4 Cameras</p>  | <p>Displays the video of up to 4 cameras.</p>  |
| <p>Layout style 3: 6 Cameras</p> | <p>Displays the video of up to 6 cameras.</p> |

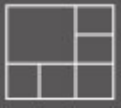
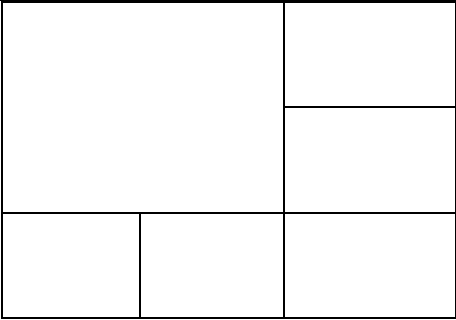
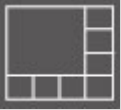
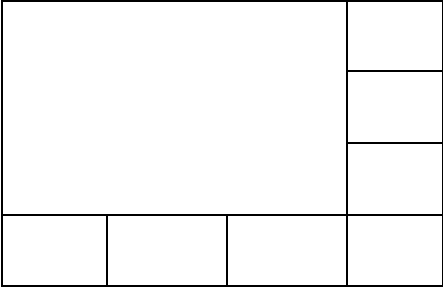
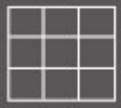
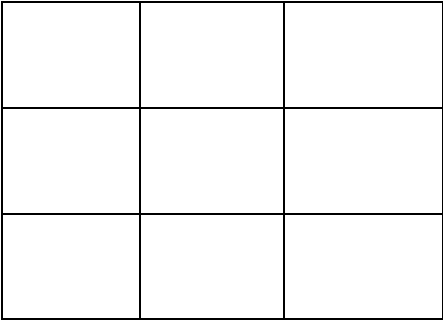
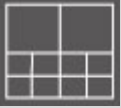
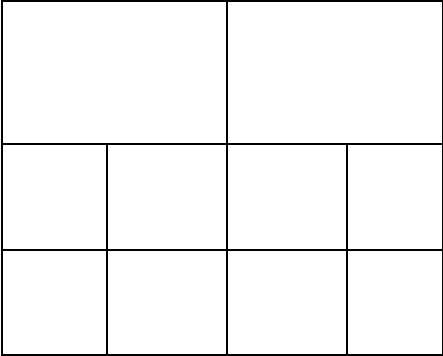
| | |
|--|---|
|  |  |
| <p>Layout style 4: 8 Cameras</p>  | <p>Displays the video of up to 8 cameras.</p>  |
| <p>Layout style 5: 9 Cameras</p>  | <p>Displays the video of up to 9 cameras.</p>  |
| <p>Layout style 6: 10 Cameras</p>  | <p>Displays the video of up to 10 cameras.</p>  |

**Layout style 7: 13
Cameras**

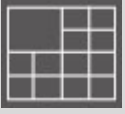

Displays the video of up to 13 cameras.

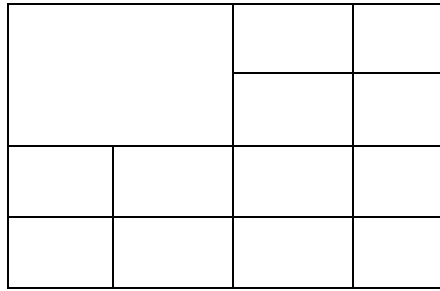

**Layout style 8: 16
Cameras**

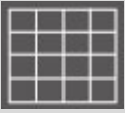

Displays the video of up to 16 cameras.

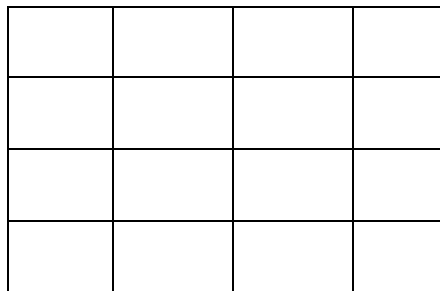

VI-5. Full Screen Mode

If you want to use all available space on your monitor to display the surveillance image, you can click the 'Full Screen' button to switch the display mode to full-screen mode.

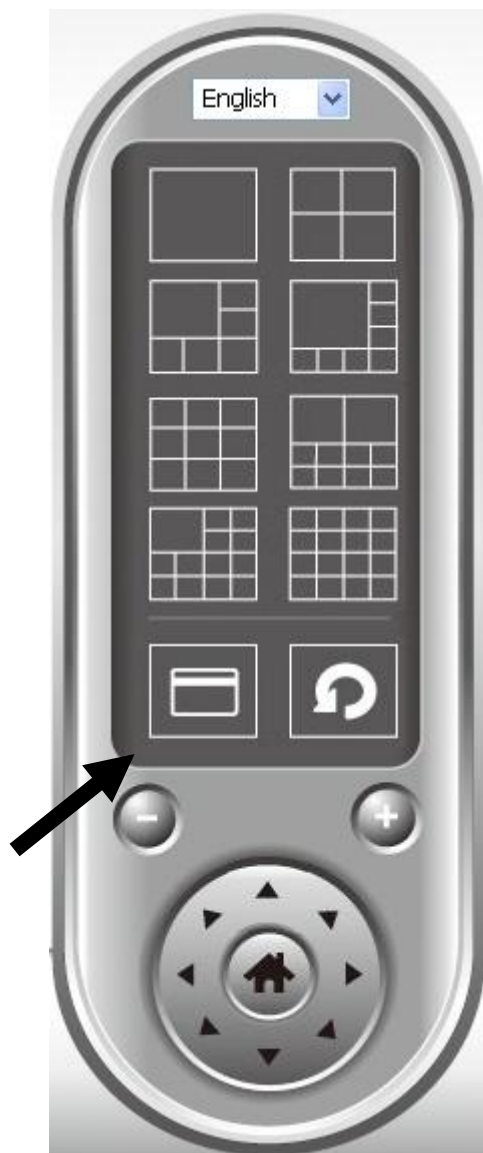



To exit full-screen mode, press the 'ESC' key.

VI-6. Scan

If you have more than one camera configured, and you wish to switch the display image between cameras, you can click the 'Scan' button to switch between all configured cameras.

 ***"Disconnected" will be displayed in the image window when a configured camera is disconnected.***





Click the 'Scan' button once to activate the scan function (the scan icon will become blue ) , click again to stop scanning (the scan icon will become white ).

VI-7. Zoom In/Out

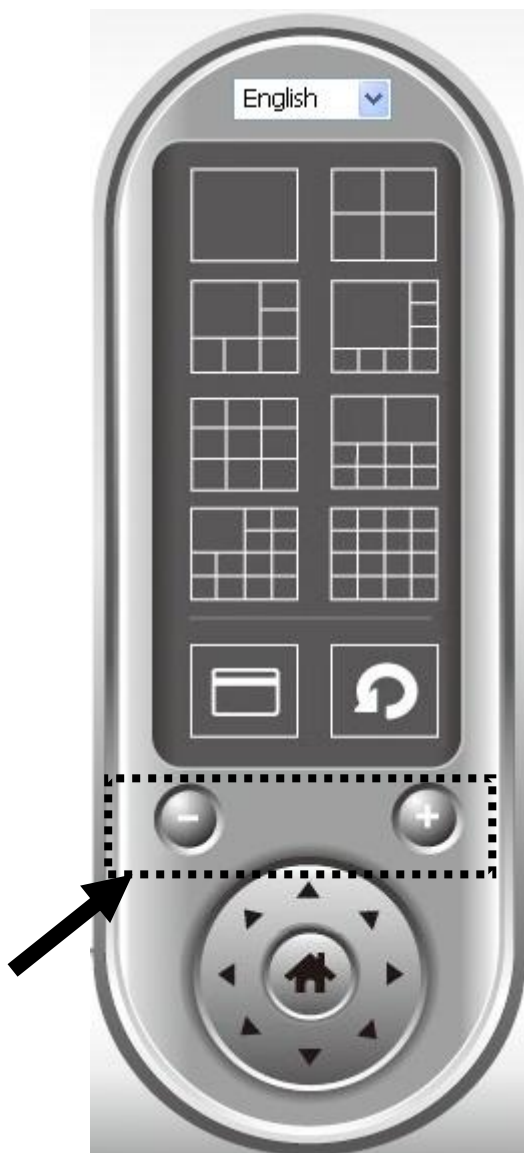
For cameras that support the zoom-in / zoom-out function, you can use this function to see more objects within the camera's view, or enlarge the image size of a certain object to see it in detail.



Please select a camera in the video display area by clicking on its image, then click the  button to see more objects within the camera's view, or click  to enlarge the image size of a certain object to see it in more detail (before zooming in, you may need to use the PTZ buttons - described in the next section - to find the object you wish to see in detail).

VI-8. Pan & Tilt

For cameras that support pan - tilt functions, you can change the direction that the camera points to, to see different places that fall within the camera's view.



Please select a camera in the video display area by clicking on its image, and then click the directions you wish the camera to move to (total 8 directions available). Click the 'Home' button (🏠) to return to the camera's home (default) position.

VI-9. Snapshot

You can take a snapshot of a selected camera and save it to a 'Snapshot' sub-folder in a pre-defined data directory.



Click the snapshot button once to take a snapshot; you can take as many snapshots as you want until the hard disk is full.

VI-10. Recording

You can start video recording a selected camera's image by clicking the 'Start Recording' button:



When recording starts, you'll see a message displayed in the message display box, such as '1/1 10:00:00, Camera 2 Start Manual', which means camera 2 started recording manually on 1/1 at 10:00:00.

To stop recording, click the 'Start Recording' button again, and you'll see a message displayed in the message display box such as '1/1 10:00:00, Camera 2 Stop Manual'.

VI-11. Video Playback

You can playback all recorded video by clicking this button.



A new window will appear:

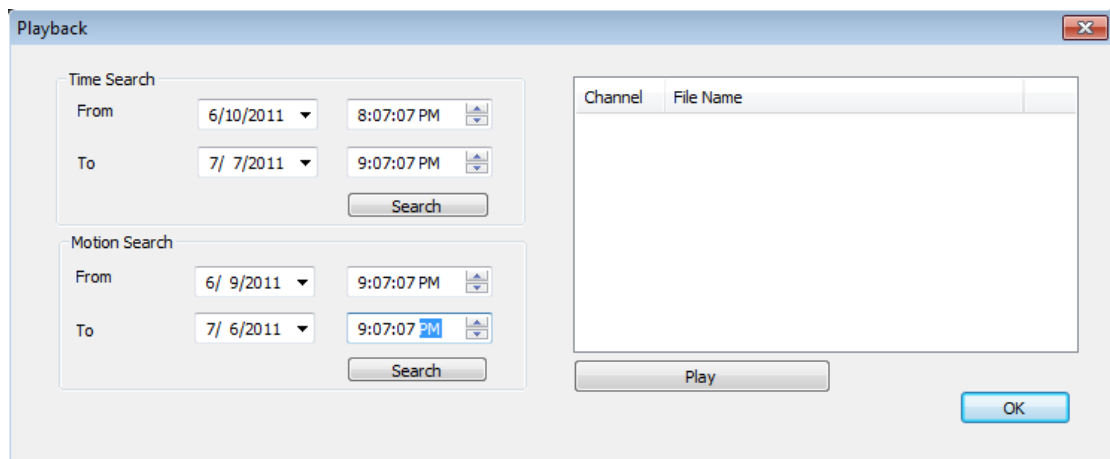

You have to search the video file before you can play it. There are two kinds of video search: Time Search (search all videos file that fall within a specific period of time) and Motion Search (search all videos recorded by the motion detection function and fall within a specific period of time).

Please define the start and end date / time of the time period you wish to search, and then click the 'Search' button (under 'Time Search' or 'Motion Search'). All found videos will be displayed, select the video you wish to play and click the 'Play' button to playback.

VII. EdiView App

You can use the free EdiView smartphone app to monitor your camera remotely using a smartphone from any Internet connection. The network camera's **green** LED must display **on** to indicate a successful cloud connection, in order for this function to work.

 **EdiView app screens may vary slightly according to version and future updates.**

1. Search the Apple app store or Google Play for “EdiView”. Download and install the EdiView app.

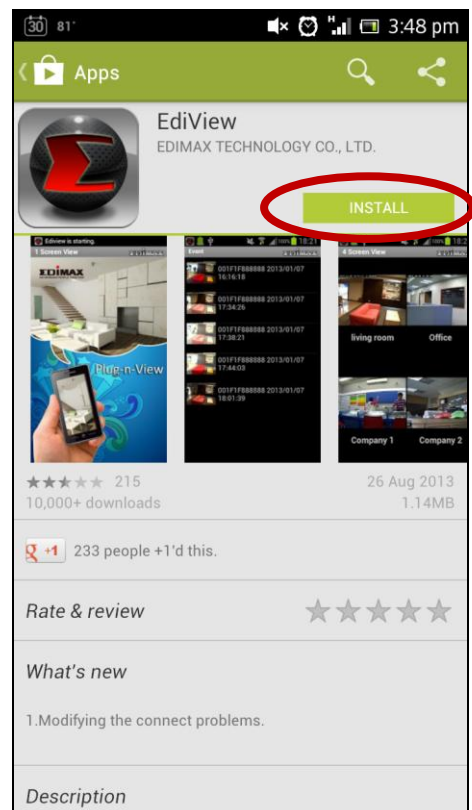

2. Run the EdiView app. iOS users select “Add new camera” and Android users select “Yes” to search for available cameras.

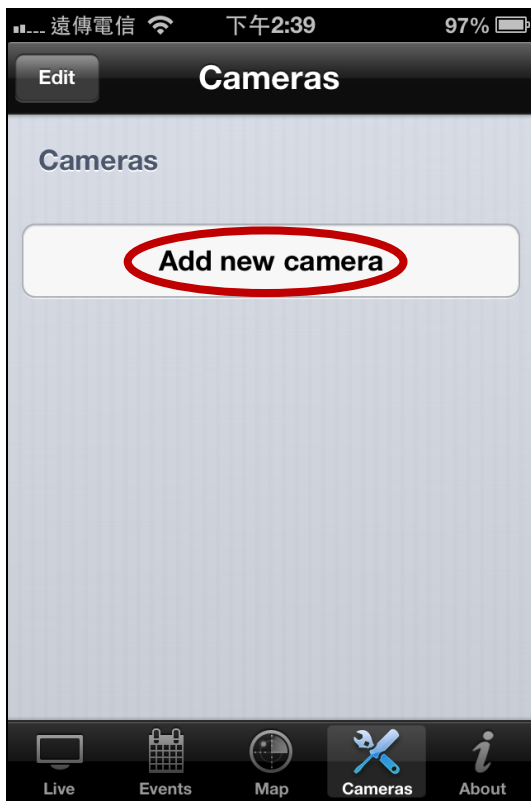

3. Select your network camera, enter the password when prompted (default password is 1234) and tap “OK”.

iOS:



Android:

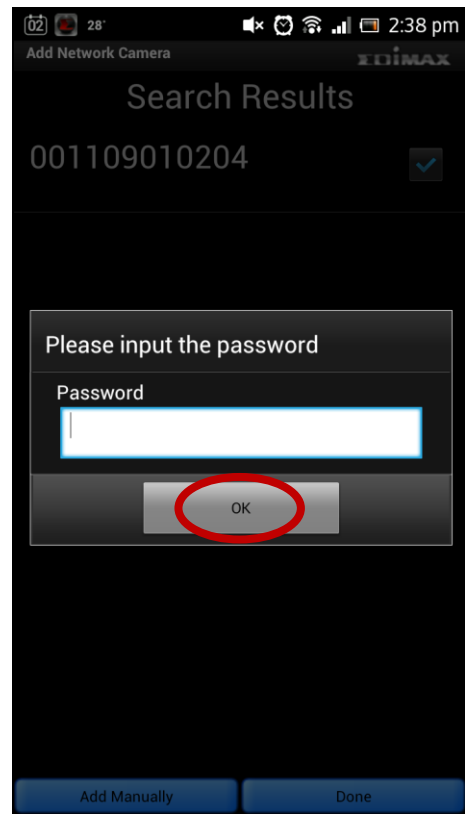
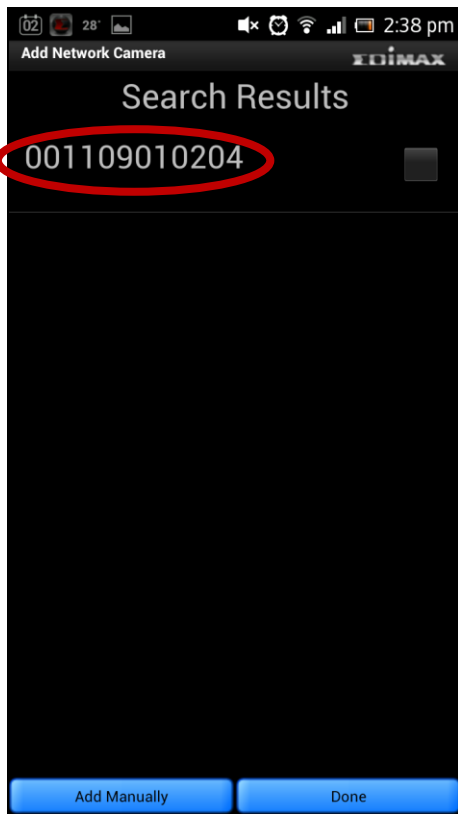

4. Android users select the camera name and tap “Done”. iOS users tap “Live” from the menu across the bottom of the screen.

Android:

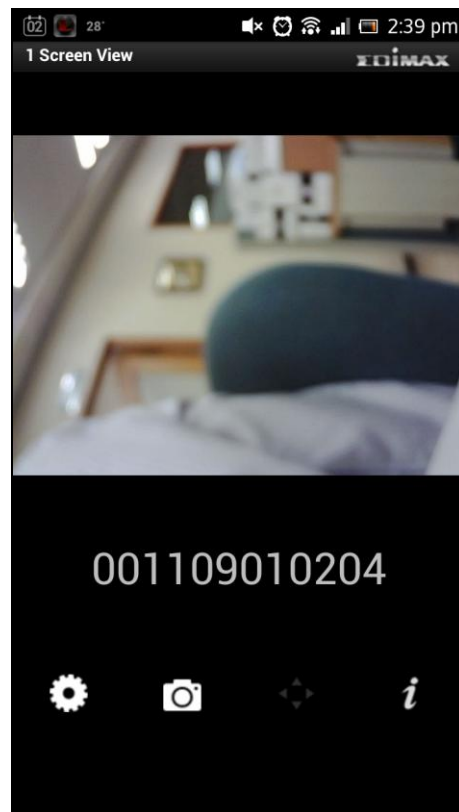
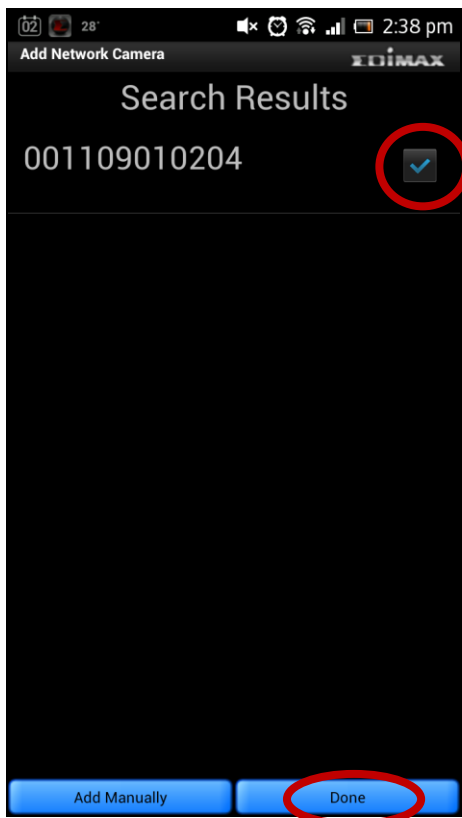

iOS:

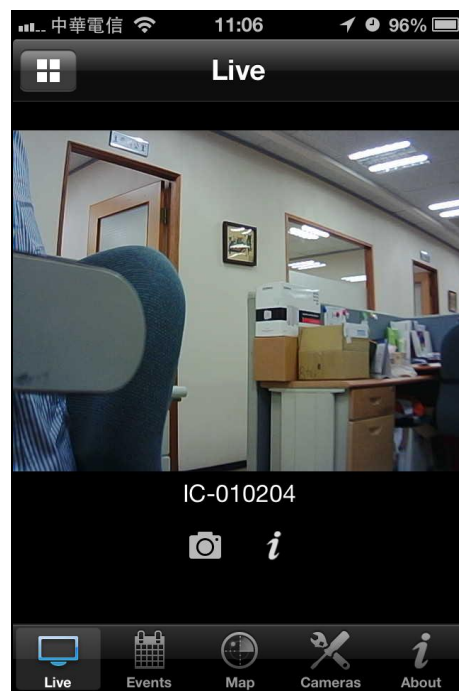

Federal Communication Commission Interference Statement

This equipment has been tested and found to comply with the limits for a Class B digital device, pursuant to Part 15 of FCC Rules. These limits are designed to provide reasonable protection against harmful interference in a residential installation. This equipment generates, uses, and can radiate radio frequency energy and, if not installed and used in accordance with the instructions, may cause harmful interference to radio communications. However, there is no guarantee that interference will not occur in a particular installation. If this equipment does cause harmful interference to radio or television reception, which can be determined by turning the equipment off and on, the user is encouraged to try to correct the interference by one or more of the following measures:

1. Reorient or relocate the receiving antenna.
2. Increase the separation between the equipment and receiver.
3. Connect the equipment into an outlet on a circuit different from that to which the receiver is connected.
4. Consult the dealer or an experienced radio technician for help.

FCC Caution

This device and its antenna must not be co-located or operating in conjunction with any other antenna or transmitter. This device complies with Part 15 of the FCC Rules. Operation is subject to the following two conditions: (1) this device may not cause harmful interference, and (2) this device must accept any interference received, including interference that may cause undesired operation. Any changes or modifications not expressly approved by the party responsible for compliance could void the authority to operate equipment.

Federal Communications Commission (FCC) Radiation Exposure Statement

This equipment complies with FCC radiation exposure set forth for an uncontrolled environment. In order to avoid the possibility of exceeding the FCC radio frequency exposure limits, human proximity to the antenna shall not be less than 2.5cm (1 inch) during normal operation.

Federal Communications Commission (FCC) RF Exposure Requirements

SAR compliance has been established in the laptop computer(s) configurations with PCMCIA slot on the side near the center, as tested in the application for certification, and can be used in laptop computer(s) with substantially similar physical dimensions, construction, and electrical and RF characteristics. Use in other devices such as PDAs or lap pads is not authorized. This transmitter is restricted for use with the specific antenna tested in the application for certification. The antenna(s) used for this transmitter must not be co-located or operating in conjunction with any other antenna or transmitter.

R&TTE Compliance Statement

This equipment complies with all the requirements of DIRECTIVE 1999/5/EC OF THE EUROPEAN PARLIAMENT AND THE COUNCIL of March 9, 1999 on radio equipment and telecommunication terminal equipment and the mutual recognition of their conformity (R&TTE). The R&TTE Directive repeals and replaces in the directive 98/13/EEC (Telecommunications Terminal Equipment and Satellite Earth Station Equipment) As of April 8, 2000.

Safety

This equipment is designed with the utmost care for the safety of those who install and use it. However, special attention must be paid to the dangers of electric shock and static electricity when working with electrical equipment. All guidelines of this and of the computer manufacture must therefore be allowed at all times to ensure the safe use of the equipment.

EU Countries Intended for Use

The ETSI version of this device is intended for home and office use in Austria, Belgium, Bulgaria, Cyprus, Czech, Denmark, Estonia, Finland, France, Germany, Greece, Hungary, Ireland, Italy, Latvia, Lithuania, Luxembourg, Malta, Netherlands, Poland, Portugal, Romania, Slovakia, Slovenia, Spain, Sweden, Turkey, and United Kingdom. The ETSI version of this device is also authorized for use in EFTA member states: Iceland, Liechtenstein, Norway, and Switzerland.

EU Countries Not Intended for Use

None

EU Declaration of Conformity

- English:** This equipment is in compliance with the essential requirements and other relevant provisions of Directive 2004/108/EC, 2006/95/EC, 2009/125/EC.
- French:** Cet équipement est conforme aux exigences essentielles et autres dispositions de la directive 2004/108/EC, 2006/95/EC, 2009/125/EC
- Czechian:** Toto zařízení je v souladu se základními požadavky a ostatními příslušnými ustanoveními směrnic 2004/108/EC, 2006/95/EC, 2009/125/EC.
- Polish:** Urządzenie jest zgodne z ogólnymi wymaganiami oraz szczególnymi warunkami określonymi Dyrektywą UE 2004/108/EC, 2006/95/EC, 2009/125/EC
- Romanian:** Acest echipament este în conformitate cu cerințele esențiale și alte prevederi relevante ale Directivei 2004/108/EC, 2006/95/EC, 2009/125/EC.
- Russian:** Это оборудование соответствует основным требованиям и положениям Директивы 2004/108/EC, 2006/95/EC, 2009/125/EC.
- Magyar:** Ez a berendezés megfelel az alapvető követelményeknek és más vonatkozó irányelveknek 2004/108/EC, 2006/95/EC, 2009/125/EC
- Türkçe:** Bu cihaz 2004/108/EC, 2006/95/EC, 2009/125/EC direktifleri zorunlu istekler ve diğer hükümlerle ile uyumludur.
- Ukrainian:** Обладнання відповідає вимогам і умовам директиви 2004/108/EC, 2006/95/EC, 2009/125/EC.
- Slovakian:** Toto zariadenie spĺňa základné požiadavky a ďalšie príslušné ustanovenia smerníc 2004/108/EC, 2006/95/EC, 2009/125/EC.
- German:** Dieses Gerät erfüllt die Voraussetzungen gemäß den Richtlinien 2004/108/EC, 2006/95/EC, 2009/125/EC.
- Spanish:** El presente equipo cumple los requisitos esenciales de la Directiva 2004/108/EC, 2006/95/EC, 2009/125/EC.
- Italian:** Questo apparecchio è conforme ai requisiti essenziali e alle altre disposizioni applicabili della Direttiva 2004/108/EC, 2006/95/EC, 2009/125/EC.
- Dutch:** Dit apparaat voldoet aan de essentiële eisen en andere van toepassing zijnde bepalingen van richtlijn 2004/108/EC, 2006/95/EC, 2009/125/EC.
- Portuguese:** Este equipamento cumpre os requisitos essenciais da Directiva 2004/108/EC, 2006/95/EC, 2009/125/EC
- Norwegian:** Dette utstyret er i samsvar med de viktigste kravene og andre relevante regler i Direktiv 2004/108/EC, 2006/95/EC, 2009/125/EC.
- Swedish:** Denna utrustning är i överensstämmelse med de väsentliga kraven och övriga relevanta bestämmelser i direktiv 2004/108/EC, 2006/95/EC, 2009/125/EC.
- Danish:** Dette udstyr er i overensstemmelse med de væsentligste krav og andre relevante forordninger i direktiv 2004/108/EC, 2006/95/EC, 2009/125/EC.
- Finnish:** Tämä laite täyttää direktiivien 2004/108/EC, 2006/95/EC, 2009/125/EC oleelliset vaatimukset ja muut asiaankuuluvat määräykset.

FOR USE IN 



WEEE Directive & Product Disposal



At the end of its serviceable life, this product should not be treated as household or general waste. It should be handed over to the applicable collection point for the recycling of electrical and electronic equipment, or returned to the supplier for disposal.

Notice According to GNU General Public License Version 2

This product includes software that is subject to the GNU General Public License version 2. The program is free software and distributed without any warranty of the author. We offer, valid for at least three years, to give you, for a charge no more than the costs of physically performing source distribution, a complete machine-readable copy of the corresponding source code.

Das Produkt beinhaltet Software, die den Bedingungen der GNU/GPL-Version 2 unterliegt. Das Programm ist eine sog. „Free Software“, der Autor stellt das Programm ohne irgendeine Gewährleistungen zur Verfügung. Wir bieten Ihnen für einen Zeitraum von drei Jahren an, eine vollständige maschinenlesbare Kopie des Quelltextes der Programme zur Verfügung zu stellen – zu nicht höheren Kosten als denen, die durch den physikalischen Kopiervorgang anfallen.

GNU GENERAL PUBLIC LICENSE

Version 2, June 1991

Copyright (C) 1989, 1991 Free Software Foundation, Inc. 51 Franklin Street, Fifth Floor, Boston, MA 02110-1301, USA
Everyone is permitted to copy and distribute verbatim copies of this license document, but changing it is not allowed.

Preamble

The licenses for most software are designed to take away your freedom to share and change it. By contrast, the GNU General Public License is intended to guarantee your freedom to share and change free software--to make sure the software is free for all its users. This General Public License applies to most of the Free Software Foundation's software and to any other program whose authors commit to using it. (Some other Free Software Foundation software is covered by the GNU Lesser General Public License instead.) You can apply it to your programs, too.

When we speak of free software, we are referring to freedom, not price. Our General Public Licenses are designed to make sure that you have the freedom to distribute copies of free software (and charge for this service if you wish), that you receive source code or can get it if you want it, that you can change the software or use pieces of it in new free programs; and that you know you can do these things.

To protect your rights, we need to make restrictions that forbid anyone to deny you these rights or to ask you to surrender the rights. These restrictions translate to certain responsibilities for you if you distribute copies of the software, or if you modify it.

For example, if you distribute copies of such a program, whether gratis or for a fee, you must give the recipients all the rights that you have. You must make sure that they, too, receive or can get the source code. And you must show them these terms so they know their rights.

We protect your rights with two steps: (1) copyright the software, and (2) offer you this license which gives you legal permission to copy, distribute and/or modify the software.

Also, for each author's protection and ours, we want to make certain that everyone understands that there is no warranty for this free software. If the software is modified by someone else and passed on, we want its recipients to know that what they have is not the original, so that any problems introduced by others will not reflect on the original authors' reputations.

Finally, any free program is threatened constantly by software patents. We wish to avoid the danger that redistributors of a free program will individually obtain patent licenses, in effect making the program proprietary. To prevent this, we have made it clear that any patent must be licensed for everyone's free use or not licensed at all.

The precise terms and conditions for copying, distribution and modification follow.

TERMS AND CONDITIONS FOR COPYING, DISTRIBUTION AND MODIFICATION

0. This License applies to any program or other work which contains a notice placed by the copyright holder saying it may be distributed under the terms of this General Public License. The "Program", below, refers to any such program or work, and a "work based on the Program" means either the Program or any derivative work under copyright law: that is to say, a work containing the Program or a portion of it, either verbatim or with modifications and/or translated into another language. (Hereinafter, translation is included without limitation in the term "modification".) Each licensee is addressed as "you".

Activities other than copying, distribution and modification are not covered by this License; they are outside its scope. The act of running the Program is not restricted, and the output from the Program is covered only if its contents constitute a work based on the Program (independent of having been made by running the Program). Whether that is true depends on what the Program does.

1. You may copy and distribute verbatim copies of the Program's source code as you receive it, in any medium, provided that you conspicuously and appropriately publish on each copy an appropriate copyright notice and disclaimer of warranty; keep intact all the notices that refer to this License and to the absence of any warranty; and give any other recipients of the Program a copy of this License along with the Program.

You may charge a fee for the physical act of transferring a copy, and you may at your option offer warranty protection in exchange for a fee.

2. You may modify your copy or copies of the Program or any portion of it, thus forming a work based on the Program, and copy and distribute such modifications or work under the terms of Section 1 above, provided that you also meet all of these conditions:

- a) You must cause the modified files to carry prominent notices stating that you changed the files and the date of any change.
- b) You must cause any work that you distribute or publish, that in whole or in part contains or is derived from the Program or any part thereof, to be licensed as a whole at no charge to all third parties under the terms of this License.
- c) If the modified program normally reads commands interactively when run, you must cause it, when started running for such interactive use in the most ordinary way, to print or display an announcement including an appropriate copyright notice and a notice that there is no warranty (or else, saying that you provide a warranty) and that users may redistribute the program under these conditions, and telling the user how to view a copy of this License. (Exception: if the Program itself is interactive but does not normally print such an announcement, your work based on the Program is not required to print an announcement.)

These requirements apply to the modified work as a whole. If identifiable sections of that work are not derived from the Program, and can be reasonably considered independent and separate works in themselves, then this License, and its terms, do not apply to those sections when you distribute them as separate works. But when you distribute the same sections as part of a whole which is a work based on the Program, the distribution of the whole must be on the terms of this License, whose permissions for other licensees extend to the entire whole, and thus to each and every part regardless of who wrote it.

Thus, it is not the intent of this section to claim rights or contest your rights to work written entirely by you; rather, the intent is to exercise the right to control the distribution of derivative or collective works based on the Program.

In addition, mere aggregation of another work not based on the Program with the Program (or with a work based on the Program) on a volume of a storage or distribution medium does not bring the other work under the scope of this License.

3. You may copy and distribute the Program (or a work based on it, under Section 2) in object code or executable form under the terms of Sections 1 and 2 above provided that you also do one of the following:

- a) Accompany it with the complete corresponding machine-readable source code, which must be distributed under the terms of Sections 1 and 2 above on a medium customarily used for software interchange; or,
- b) Accompany it with a written offer, valid for at least three years, to give any third party, for a charge no more than your cost of physically performing source distribution, a complete machine-readable copy of the corresponding source code, to be distributed under the terms of Sections 1 and 2 above on a medium customarily used for software interchange; or,
- c) Accompany it with the information you received as to the offer to distribute corresponding source code. (This alternative is allowed only for noncommercial distribution and only if you received the program in object code or executable form with such an offer, in accord with Subsection b above.)

The source code for a work means the preferred form of the work for making modifications to it. For an executable work, complete source code means all the source code for all modules it contains, plus any associated interface definition files, plus the scripts used to control compilation and installation of the executable. However, as a special exception, the source code distributed need not include anything that is normally distributed (in either source or binary form) with the major components (compiler, kernel, and so on) of the operating system on which the executable runs, unless that component itself accompanies the executable.

If distribution of executable or object code is made by offering access to copy from a designated place, then offering equivalent access to copy the source code from the same place counts as distribution of the source code, even though third parties are not compelled to copy the source along with the object code.

4. You may not copy, modify, sublicense, or distribute the Program except as expressly provided under this License. Any attempt otherwise to copy, modify, sublicense or distribute the Program is void, and will automatically terminate your rights under this License. However, parties who have received copies, or rights, from you under this License will not have their licenses terminated so long as such parties remain in full compliance.

5. You are not required to accept this License, since you have not signed it. However, nothing else grants you permission to modify or distribute the Program or its derivative works. These actions are prohibited by law if you do not accept this License.

Therefore, by modifying or distributing the Program (or any work based on the Program), you indicate your acceptance of this License to do so, and all its terms and conditions for copying, distributing or modifying the Program or works based on it.

6. Each time you redistribute the Program (or any work based on the Program), the recipient automatically receives a license from the original licensor to copy, distribute or modify the Program subject to these terms and conditions. You may not impose any further restrictions on the recipients' exercise of the rights granted herein. You are not responsible for enforcing compliance by third parties to this License.

7. If, as a consequence of a court judgment or allegation of patent infringement or for any other reason (not limited to patent issues), conditions are imposed on you (whether by court order, agreement or otherwise) that contradict the conditions of this License, they do not excuse you from the conditions of this License. If you cannot distribute so as to satisfy simultaneously your obligations under this License and any other pertinent obligations, then as a consequence you may not distribute the Program at all. For example, if a patent license would not permit royalty-free redistribution of the Program by all those who receive copies directly or indirectly through you, then the only way you could satisfy both it and this License would be to refrain entirely from distribution of the Program.

If any portion of this section is held invalid or unenforceable under any particular circumstance, the balance of the section is intended to apply and the section as a whole is intended to apply in other circumstances.

It is not the purpose of this section to induce you to infringe any patents or other property right claims or to contest validity of any such claims; this section has the sole purpose of protecting the integrity of the free software distribution system, which is implemented by public license practices. Many people have made generous contributions to the wide range of software distributed through that system in reliance on consistent application of that system; it is up to the author/donor to decide if he or she is willing to distribute software through any other system and a licensee cannot impose that choice.

This section is intended to make thoroughly clear what is believed to be a consequence of the rest of this License.

8. If the distribution and/or use of the Program is restricted in certain countries either by patents or by copyrighted interfaces, the original copyright holder who places the Program under this License may add an explicit geographical distribution limitation excluding those countries, so that distribution is permitted only in or among countries not thus excluded. In such case, this License incorporates the limitation as if written in the body of this License.

9. The Free Software Foundation may publish revised and/or new versions of the General Public License from time to time. Such new versions will be similar in spirit to the present version, but may differ in detail to address new problems or concerns.

Each version is given a distinguishing version number. If the Program specifies a version number of this License which applies to it and "any later version", you have the option of following the terms and conditions either of that version or of any later version published by the Free Software Foundation. If the Program does not specify a version number of this License, you may choose any version ever published by the Free Software Foundation.

10. If you wish to incorporate parts of the Program into other free programs whose distribution conditions are different, write to the author to ask for permission. For software which is copyrighted by the Free Software Foundation, write to the Free Software Foundation; we sometimes make exceptions for this. Our decision will be guided by the two goals of preserving the free status of all derivatives of our free software and of promoting the sharing and reuse of software generally.

NO WARRANTY

11. BECAUSE THE PROGRAM IS LICENSED FREE OF CHARGE, THERE IS NO WARRANTY FOR THE PROGRAM, TO THE EXTENT PERMITTED BY APPLICABLE LAW. EXCEPT WHEN OTHERWISE STATED IN WRITING THE COPYRIGHT HOLDERS AND/OR OTHER PARTIES PROVIDE THE PROGRAM "AS IS" WITHOUT WARRANTY OF ANY KIND, EITHER EXPRESSED OR IMPLIED, INCLUDING, BUT NOT LIMITED TO, THE IMPLIED WARRANTIES OF MERCHANTABILITY AND FITNESS FOR A PARTICULAR PURPOSE. THE ENTIRE RISK AS TO THE QUALITY AND PERFORMANCE OF THE PROGRAM IS WITH YOU. SHOULD THE PROGRAM PROVE DEFECTIVE, YOU ASSUME THE COST OF ALL NECESSARY SERVICING, REPAIR OR CORRECTION.

12. IN NO EVENT UNLESS REQUIRED BY APPLICABLE LAW OR AGREED TO IN WRITING WILL ANY COPYRIGHT HOLDER, OR ANY OTHER PARTY WHO MAY MODIFY AND/OR REDISTRIBUTE THE PROGRAM AS PERMITTED ABOVE, BE LIABLE TO YOU FOR DAMAGES, INCLUDING ANY GENERAL, SPECIAL, INCIDENTAL OR CONSEQUENTIAL DAMAGES ARISING OUT OF THE USE OR INABILITY TO USE THE PROGRAM (INCLUDING BUT NOT LIMITED TO LOSS OF DATA OR DATA BEING RENDERED INACCURATE OR LOSSES SUSTAINED BY YOU OR THIRD PARTIES OR A FAILURE OF THE PROGRAM TO OPERATE WITH ANY OTHER PROGRAMS), EVEN IF SUCH HOLDER OR OTHER PARTY HAS BEEN ADVISED OF THE POSSIBILITY OF SUCH DAMAGES.



Edimax Technology Co., Ltd
6F., No.3, Wu-Chuan 3rd Road, Wu-Gu,
New Taipei City, Taiwan

Edimax Technology Europe B.V.
Nijverheidsweg 25 5683 CJ Best
The Netherlands

Edimax Computer Company
3350 Scott Blvd., Bldg.15 Santa Clara,
CA 95054, USA