

U.I. Lapp GmbH	DATASHEET	
	SKINDICHT® SHVE	52010500 14.11.2013

Optimum, low-resistance 360° screen contact
High degree of protection
High strain relief



Optimum strain relief



Reliability



Interference signals



Temperature-resistant



Application range

Earthing gland, for applications where electrical interference fields can occur.
Medical engineering
Frequency converters
Airports
Measurement and control technology

Design

1 fitting
2 earth sleeves
3 sealing cones
4 cone, brass
5 compression screws

Note

Counter nut to be used: SKINDICHT® SM
EMC counter nut, SKINDICHT® SM nut should be used to ensure optimum contact with painted, anodised or powder-coated housings
Example order identification: SHVE 13.5 / 9 / 9 / 513.5 = PG thread compression screw9 = PG connection thread9 = Clear width of sealing cone5 = Clear width earthing sleeve

Remark

Photographs are not to scale and do not represent detailed images of the respective products.

Product Management	Document: SKINDICHT® SHVE	1 / 3
--------------------	---------------------------	-------

U.I. Lapp GmbH	DATASHEET	
	SKINDICHT® SHVE	52010500 14.11.2013

Technical Data

Article designation / size:	13,5/11/9/6
Outer sheath Ø, min./max. (mm):	6,8 / 8,8
Min./max. inner sheath Ø (mm):	4,5 / 6
SW (mm):	22
Overall length, C (mm):	32,5
Thread length, D (mm):	5.5
Pieces / PU:	25
Caution:	The installation dimensions can be found in appendix T21
Material:	Body: nickel-plated Earthing sleeve: blank brass Special sealing cone: CR O-ring: NBR
Protection rating:	Remark: A RoHS-non-compliant version is marketed under ÖLFLEX® 110 with VDE-REG.-Nr. 8067. To order this, please add appendix <1> to the below stated part numbers. This does not affect the above given further technical data or description.
Temperature range:	-20°C to +80°C

Product Management	Document: SKINDICHT® SHVE	2 / 3
--------------------	---------------------------	-------

U.I. Lapp GmbH	<h1>DATASHEET</h1>	 LAPP GROUP
SKINDICHT® SHVE		52010500 14.11.2013

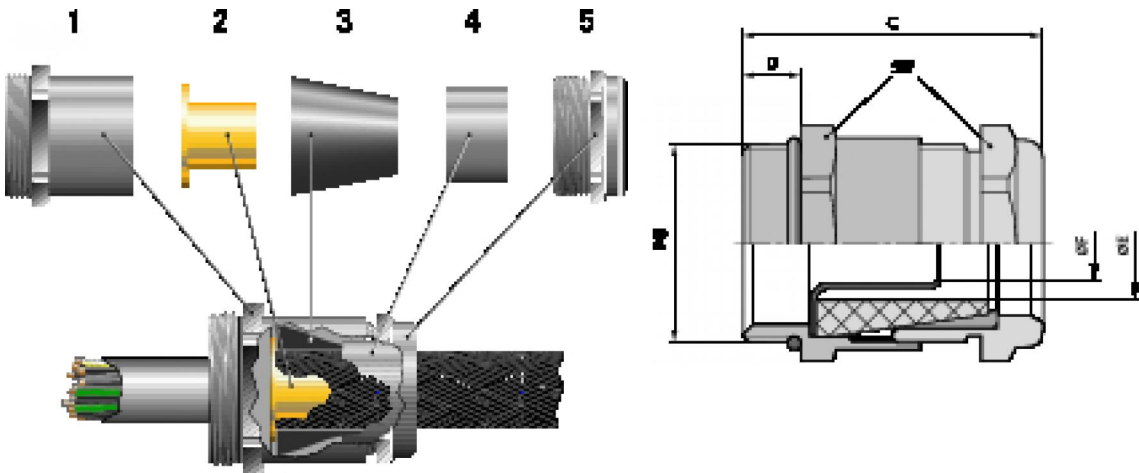

Product Management	Document: SKINDICHT® SHVE	3 / 3
--------------------	---------------------------	-------