

# CUS250LD

## RELIABILITY DATA

DWG No. CA802-57-01/LD		
APPD	CHK	DWG
<i>Zhen</i> 16-Jan-13	<i>Andrew</i> 09-Jan-13	<i>Perry</i> 09-Jan-13

## I N D E X

	PAGE
1. Calculated values of MTBF .....	R - 1
2. Component derating .....	R - 2
3. Main components temperature rise list .....	R - 5
4. Electrolytic capacitor life .....	R - 10
5. Vibration test .....	R - 15
6. Shock test .....	R - 16
7. Noise simulate test .....	R - 17
8. Thermal shock test .....	R - 18

Terminology used

FG .....Frame Ground

※ The above data is typical value. As all units have nearly the same characteristics, the data to be considered as ability value.

## 1. Calculated values of MTBF

MODEL : CUS250LD-5

### (1) Calculating method

Calculated based on part count reliability projection of JEITA (RCR-9102).

Individual failure rates  $\lambda_G$  is given to each part and MTBF is calculated by the count of each part.

<Formula> :

$$MTBF = \frac{1}{\lambda_{\text{equip}}} = \frac{1}{\sum_{i=1}^n N_i (\lambda_G \pi_Q)_i} \times 10^6 \text{ (Hours)}$$

$\lambda_{\text{equip}}$  : Total equipment failure rate (Failure/10<sup>6</sup> Hours)

$\lambda_G$  : Generic failure rate for the ith generic part (Failure/10<sup>6</sup> Hours)

$N_i$  : Quantity of ith generic part

n : Number of different generic part categories

$\pi_Q$  : Generic quality factor for the ith generic part ( $\pi_Q = 1$ )

### (2) MTBF values

$G_F$  : (Ground , Fixed)

**MTBF =158,374 (Hours)**

2. Component derating

MODEL : CUS250LD-5

(1) Calculating method

(a) Measuring Conditions

Input : 115VAC/230VAC      Ambient temperature : 40°C  
 Output : 5V, 50A(100%)      Mounting method : Mounting A,B,C,D,E

(b) Semiconductors

Compared with maximum junction temperature and actual one which is calculated based on maximum case temperature in mounting A~E condition, power dissipation and thermal impedance.

(c) IC, Resistors, Capacitors, etc.

Ambient temperature, operating condition, power dissipation and so on are within derating criteria.

(d) Calculating Method of Thermal Impedance

$$\theta_{j-c} = \frac{T_{j(max)} - T_c}{P_{c(max)}} \quad \theta_{j-a} = \frac{T_{j(max)} - T_a}{P_{c(max)}} \quad \theta_{j-l} = \frac{T_{j(max)} - T_l}{P_{c(max)}}$$

- $T_c$  : Case temperature at start point of derating ; 25°C in general
- $T_a$  : Ambient temperature at start point of derating ; 25°C in general
- $T_l$  : Lead temperature at start point of derating ; 25°C in general
- $P_{c(max)}$   
( $P_{ch(max)}$ ) : Maximum collector(channel) dissipation
- $T_{j(max)}$   
( $T_{ch(max)}$ ) : Maximum junction(channel) temperature
- $\theta_{j-c}$   
( $\theta_{ch-c}$ ) : Thermal impedance between junction(channel) and case
- $\theta_{j-a}$  : Thermal impedance between junction and air
- $\theta_{j-l}$  : Thermal impedance between junction and lead

## 2. Component derating list

Location No.	$V_{in} = 115VAC$	$Load = 100\%$	$T_a = 40^{\circ}C$
Q1 IPP60R199CP INFINEON	$T_{ch(max)} = 150^{\circ}C,$ $P_{ch} = 6.8W,$ $T_{ch} = T_c + ((\theta_{ch-c}) \times P_{ch}) = 127^{\circ}C$ $D.F. = 84.7\%$	$\theta_{ch-c} = 0.9^{\circ}C/W,$ $\Delta T_c = 81^{\circ}C,$	$P_{ch(max)} = 139W,$ $T_c = 121^{\circ}C$
Q2,Q3 IPP60R280C6 INFINEON	$T_{ch(max)} = 150^{\circ}C,$ $P_{ch} = 1.7W,$ $T_{ch} = T_c + ((\theta_{ch-c}) \times P_{ch}) = 121^{\circ}C$ $D.F. = 80.7\%$	$\theta_{ch-c} = 1.2^{\circ}C/W,$ $\Delta T_c = 79^{\circ}C,$	$P_{ch(max)} = 104W,$ $T_c = 119^{\circ}C$
D1 RS1005M RECTRON	$T_j(max) = 150^{\circ}C,$ $P_d = 4.0W,$ $T_j = T_c + ((\theta_{j-c}) \times P_d) = 118^{\circ}C$ $D.F. = 78.7\%$	$\theta_{j-c} = 1.2^{\circ}C/W,$ $\Delta T_c = 73^{\circ}C,$	$T_c = 113^{\circ}C$
D2 IDH04SG60C INFINEON	$T_j(max) = 150^{\circ}C,$ $P_d = 1.3W,$ $T_j = T_c + ((\theta_{j-c}) \times P_d) = 120^{\circ}C$ $D.F. = 80.0\%$	$\theta_{j-c} = 3.6^{\circ}C/W,$ $\Delta T_c = 75^{\circ}C,$	$T_c = 115^{\circ}C$
D3, D4 MUR460 MOTOROLA	$T_j(max) = 150^{\circ}C,$ $P_d = 0.15W,$ $T_j = T_c + ((\theta_{j-c}) \times P_d) = 115^{\circ}C$ $D.F. = 76.7\%$	$\theta_{j-c} = 28^{\circ}C/W,$ $\Delta T_c = 71^{\circ}C,$	$T_c = 111^{\circ}C$
Q51,Q52 IPP041N04NG INFINEON	$T_{ch(max)} = 150^{\circ}C,$ $P_{ch} = 2.2W,$ $T_{ch} = T_c + ((\theta_{ch-c}) \times P_{ch}) = 111^{\circ}C$ $D.F. = 74.0\%$	$\theta_{ch-c} = 1.6^{\circ}C/W,$ $\Delta T_c = 67^{\circ}C,$	$P_{ch(max)} = 94W,$ $T_c = 107^{\circ}C$
Q53,Q54 IPP037N08N3G INFINEON	$T_{ch(max)} = 150^{\circ}C,$ $P_{ch} = 3.2W,$ $T_{ch} = T_c + ((\theta_{ch-c}) \times P_{ch}) = 111^{\circ}C$ $D.F. = 74.0\%$	$\theta_{ch-c} = 0.7^{\circ}C/W,$ $\Delta T_c = 69^{\circ}C,$	$P_{ch(max)} = 214W,$ $T_c = 109^{\circ}C$
A101 ICE2PCS03G INFINEON	$T_j(max) = 150^{\circ}C,$ $P_d = 0.17W,$ $T_j = T_c + ((\theta_{j-c}) \times P_d) = 111^{\circ}C$ $D.F. = 74.0\%$	$\theta_{j-c} = 72^{\circ}C/W,$ $\Delta T_c = 59^{\circ}C,$	$T_c = 99^{\circ}C$
A102 FA5604N-D1-TE1 FUJI ELECTRIC	$T_j(max) = 150^{\circ}C,$ $P_d = 0.15W,$ $T_j = T_c + ((\theta_{j-c}) \times P_d) = 115^{\circ}C$ $D.F. = 76.7\%$	$\theta_{j-c} = 72^{\circ}C/W,$ $\Delta T_c = 64^{\circ}C,$	$T_c = 104^{\circ}C$
A201 AZ431BR-ATRE1 BCD	$T_j(max) = 150^{\circ}C,$ $P_d = 0.01W,$ $T_j = T_c + ((\theta_{j-c}) \times P_d) = 98^{\circ}C$ $D.F. = 65.3\%$	$\theta_{j-c} = 250^{\circ}C/W,$ $\Delta T_c = 55^{\circ}C,$	$T_c = 95^{\circ}C$
PC101 PS2861B-1Y-F3-A(L) (LED) RENESAS	$T_j(max) = 125^{\circ}C,$ $P_d = 1mW,$ $ALLOWABLE P_d(max) = 15.6mW (at T_c = 99^{\circ}C)$ $D.F. = 6.4\%$	$\Delta P_d/^{\circ}C = -0.6mW/^{\circ}C,$ $\Delta T_c = 59^{\circ}C,$	$P_c(max) = 60mW,$ $T_c = 99^{\circ}C$
PC101 PS2861B-1Y-F3-A(L) (Transistor) RENESAS	$T_j(max) = 125^{\circ}C,$ $P_c = 4mW,$ $ALLOWABLE P_c(max) = 31.2mW (at T_c = 99^{\circ}C)$ $D.F. = 12.8\%$	$\Delta P_c/^{\circ}C = -1.2mW/^{\circ}C,$ $\Delta T_c = 59^{\circ}C,$	$P_c(max) = 120mW,$ $T_c = 99^{\circ}C$
PC102 PS2861B-1Y-F3-A(L) (LED) RENESAS	$T_j(max) = 125^{\circ}C,$ $P_d = 0mW,$ $ALLOWABLE P_d(max) = 16.8mW (at T_c = 97^{\circ}C)$ $D.F. = 0\%$	$\Delta P_d/^{\circ}C = -0.6mW/^{\circ}C,$ $\Delta T_c = 57^{\circ}C,$	$P_c(max) = 60mW,$ $T_c = 97^{\circ}C$
PC102 PS2861B-1Y-F3-A(L) (Transistor) RENESAS	$T_j(max) = 125^{\circ}C,$ $P_c = 0mW,$ $ALLOWABLE P_c(max) = 33.6mW (at T_c = 97^{\circ}C)$ $D.F. = 0\%$	$\Delta P_c/^{\circ}C = -1.2mW/^{\circ}C,$ $\Delta T_c = 57^{\circ}C,$	$P_c(max) = 120mW,$ $T_c = 97^{\circ}C$

## 2. Component derating list

Location No.	$V_{in} = 230VAC$	$Load = 100\%$	$T_a = 40^{\circ}C$
Q1 IPP60R199CP INFINEON	$T_{ch(max)} = 150^{\circ}C,$ $P_{ch} = 2.5W,$ $T_{ch} = T_c + ((\theta_{ch-c}) \times P_{ch}) = 94^{\circ}C$ $D.F. = 62.7\%$	$\theta_{ch-c} = 0.9^{\circ}C/W,$ $\Delta T_c = 52^{\circ}C,$	$P_{ch(max)} = 139W,$ $T_c = 92^{\circ}C$
Q2,Q3 IPP60R280C6 INFINEON	$T_{ch(max)} = 150^{\circ}C,$ $P_{ch} = 1.7W,$ $T_{ch} = T_c + ((\theta_{ch-c}) \times P_{ch}) = 107^{\circ}C$ $D.F. = 71.3\%$	$\theta_{ch-c} = 1.2^{\circ}C/W,$ $\Delta T_c = 65^{\circ}C,$	$P_{ch(max)} = 104W,$ $T_c = 105^{\circ}C$
D1 RS1005M RECTRON	$T_j(max) = 150^{\circ}C,$ $P_d = 2.0W,$ $T_j = T_c + ((\theta_{j-c}) \times P_d) = 94^{\circ}C$ $D.F. = 62.7\%$	$\theta_{j-c} = 1.2^{\circ}C/W,$ $\Delta T_c = 52^{\circ}C,$	$T_c = 92^{\circ}C$
D2 IDH04SG60C INFINEON	$T_j(max) = 150^{\circ}C,$ $P_d = 1.1W,$ $T_j = T_c + ((\theta_{j-c}) \times P_d) = 98^{\circ}C$ $D.F. = 65.3\%$	$\theta_{j-c} = 3.6^{\circ}C/W,$ $\Delta T_c = 54^{\circ}C,$	$T_c = 94^{\circ}C$
D3, D4 MUR460 MOTOROLA	$T_j(max) = 150^{\circ}C,$ $P_d = 0.15W,$ $T_j = T_c + ((\theta_{j-c}) \times P_d) = 103^{\circ}C$ $D.F. = 68.7\%$	$\theta_{j-c} = 28^{\circ}C/W,$ $\Delta T_c = 59^{\circ}C,$	$T_c = 99^{\circ}C$
Q51,Q52 IPP041N04NG INFINEON	$T_{ch(max)} = 150^{\circ}C,$ $P_{ch} = 2.2W,$ $T_{ch} = T_c + ((\theta_{ch-c}) \times P_{ch}) = 101^{\circ}C$ $D.F. = 67.3\%$	$\theta_{ch-c} = 1.6^{\circ}C/W,$ $\Delta T_c = 57^{\circ}C,$	$P_{ch(max)} = 94W,$ $T_c = 97^{\circ}C$
Q53,Q54 IPP037N08N3G INFINEON	$T_{ch(max)} = 150^{\circ}C,$ $P_{ch} = 3.2W,$ $T_{ch} = T_c + ((\theta_{ch-c}) \times P_{ch}) = 101^{\circ}C$ $D.F. = 67.3\%$	$\theta_{ch-c} = 0.7^{\circ}C/W,$ $\Delta T_c = 59^{\circ}C,$	$P_{ch(max)} = 214W,$ $T_c = 99^{\circ}C$
A101 ICE2PCS03G INFINEON	$T_j(max) = 150^{\circ}C,$ $P_d = 0.17W,$ $T_j = T_c + ((\theta_{j-c}) \times P_d) = 99^{\circ}C$ $D.F. = 66.0\%$	$\theta_{j-c} = 72^{\circ}C/W,$ $\Delta T_c = 47^{\circ}C,$	$T_c = 87^{\circ}C$
A102 FA5604N-D1-TE1 FUJI ELECTRIC	$T_j(max) = 150^{\circ}C,$ $P_d = 0.15W,$ $T_j = T_c + ((\theta_{j-c}) \times P_d) = 104^{\circ}C$ $D.F. = 69.3\%$	$\theta_{j-c} = 72^{\circ}C/W,$ $\Delta T_c = 53^{\circ}C,$	$T_c = 93^{\circ}C$
A201 AZ431BR-ATRE1 BCD	$T_j(max) = 150^{\circ}C,$ $P_d = 0.01W,$ $T_j = T_c + ((\theta_{j-c}) \times P_d) = 86^{\circ}C$ $D.F. = 57.3\%$	$\theta_{j-c} = 250^{\circ}C/W,$ $\Delta T_c = 43^{\circ}C,$	$T_c = 83^{\circ}C$
PC101 PS2861B-1Y-F3-A(L) (LED) RENESAS	$T_j(max) = 125^{\circ}C,$ $P_d = 1mW,$ $ALLOWABLE P_d(max) = 21mW (at T_c = 90^{\circ}C)$ $D.F. = 4.8\%$	$\Delta P_d/^{\circ}C = -0.6mW/^{\circ}C,$ $\Delta T_c = 50^{\circ}C,$	$P_c(max) = 60mW,$ $T_c = 90^{\circ}C$
PC101 PS2861B-1Y-F3-A(L) (Transistor) RENESAS	$T_j(max) = 125^{\circ}C,$ $P_c = 4mW,$ $ALLOWABLE P_c(max) = 42mW (at T_c = 90^{\circ}C)$ $D.F. = 9.5\%$	$\Delta P_c/^{\circ}C = -1.2mW/^{\circ}C,$ $\Delta T_c = 50^{\circ}C,$	$P_c(max) = 120mW,$ $T_c = 90^{\circ}C$
PC102 PS2861B-1Y-F3-A(L) (LED) RENESAS	$T_j(max) = 125^{\circ}C,$ $P_d = 0mW,$ $ALLOWABLE P_d(max) = 22mW (at T_c = 89^{\circ}C)$ $D.F. = 0\%$	$\Delta P_d/^{\circ}C = -0.6mW/^{\circ}C,$ $\Delta T_c = 49^{\circ}C,$	$P_c(max) = 60mW,$ $T_c = 89^{\circ}C$
PC102 PS2861B-1Y-F3-A(L) (Transistor) RENESAS	$T_j(max) = 125^{\circ}C,$ $P_c = 0mW,$ $ALLOWABLE P_c(max) = 43mW (at T_c = 89^{\circ}C)$ $D.F. = 0\%$	$\Delta P_c/^{\circ}C = -1.2mW/^{\circ}C,$ $\Delta T_c = 49^{\circ}C,$	$P_c(max) = 120mW,$ $T_c = 89^{\circ}C$

## 3. Main Components Temperature Rise List

MODEL : CUS250LD-5

## (1) Measuring Conditions

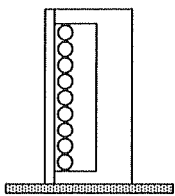
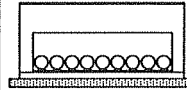
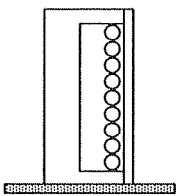
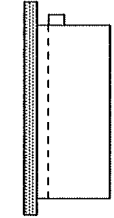
Mounting Method	Mounting A	Mounting B	Mounting C	Mounting D	Mounting E
	Standard Mounting:A				
Input Voltage	115VAC				
Output Voltage	5VDC				
Output Current	50A(100%)				



## (2) Measuring Results

Output Derating		Temperature Rise (°C)				
		Io=100 %				
		Ta=40°C	Ta=40°C	Ta=40°C	Ta=40°C	Ta=40°C
Location No.	Part name	Mounting A	Mounting B	Mounting C	Mounting D	Mounting E
A101	CHIP IC	55	52	53	56	59
A102	CHIP IC	60	56	56	59	64
A201	CHIP IC	43	40	46	55	44
C1	E.CAP.	38	35	34	35	43
C52	E.CAP.	43	43	39	48	41
C53	E.CAP.	42	42	41	50	43
C54	E.CAP.	43	40	41	45	41
D1	BRIDGE DIODE	71	69	73	73	69
D2	S.B.D	71	67	72	73	75
D3	F.R.D	68	62	64	67	71
Q1	MOSFET	77	74	78	80	81
Q2	MOSFET	77	72	73	79	78
Q3	MOSFET	69	65	67	72	72
Q52	MOSFET	64	59	60	67	64
Q53	MOSFET	65	60	62	69	64
Q104	CHIP MOSFET	72	68	69	73	74
Q201	CHIP MOSFET	74	72	72	79	75
L3	BALUN COIL	44	52	56	63	49
L4	BALUN COIL	52	60	60	66	56
L5	CHOKE COIL	66	70	65	70	64
L51	CHOKE COIL	58	59	55	62	56
T1 WIRE	TRANSFORMER WIRE	67	65	63	68	67
T2 WIRE	TRANSFORMER WIRE	53	49	46	49	61
PC101	PHOTO COUPLER	56	54	55	57	59
PC102	PHOTO COUPLER	55	53	54	56	57

## 3. Main Components Temperature Rise List

MODEL : CUS250LD-5

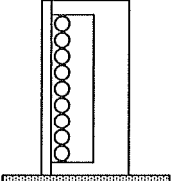
## (1) Measuring Conditions

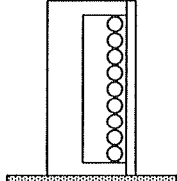
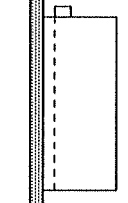
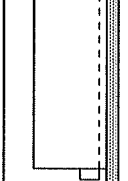
Mounting Method	Mounting A	Mounting B	Mounting C	Mounting D	Mounting E
Standard Mounting:A					
Input Voltage	115VAC				
Output Voltage	5VDC				
Output Current	45A(90%)				

## (2) Measuring Results

Output Derating		Temperature Rise (°C)				
		Io=90 %				
		Ta=50°C	Ta=50°C	Ta=50°C	Ta=50°C	Ta=50°C
Location No.	Part name	Mounting A	Mounting B	Mounting C	Mounting D	Mounting E
A101	CHIP IC	53	45	49	49	56
A102	CHIP IC	57	49	51	51	60
A201	CHIP IC	40	34	42	45	40
C1	E.CAP.	39	28	33	33	44
C52	E.CAP.	36	34	34	40	36
C53	E.CAP.	37	35	37	46	40
C54	E.CAP.	38	34	37	43	38
D1	BRIDGE DIODE	63	56	62	61	62
D2	S.B.D	58	51	60	58	63
D3	F.R.D	61	54	57	56	64
Q1	MOSFET	64	55	63	62	67
Q2	MOSFET	67	58	63	64	67
Q3	MOSFET	62	53	58	59	63
Q52	MOSFET	57	50	54	55	57
Q53	MOSFET	58	50	55	57	57
Q104	CHIP MOSFET	66	59	62	63	67
Q201	CHIP MOSFET	68	62	66	68	68
L3	BALUN COIL	40	42	49	52	44
L4	BALUN COIL	46	48	52	55	51
L5	CHOKE COIL	64	60	60	64	64
L51	CHOKE COIL	52	49	48	52	52
T1 WIRE	TRANSFORMER WIRE	59	55	56	55	60
T2 WIRE	TRANSFORMER WIRE	49	43	43	42	56
PC101	PHOTO COUPLER	52	45	50	49	54
PC102	PHOTO COUPLER	52	44	49	49	53



3. Main Components Temperature Rise List

MODEL : CUS250LD-5

(1) Measuring Conditions

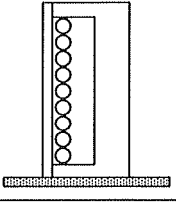
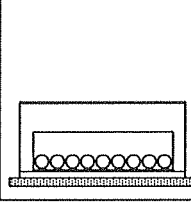
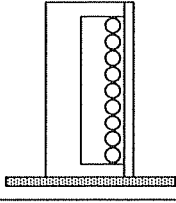
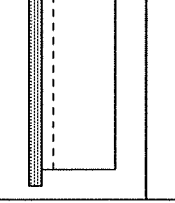
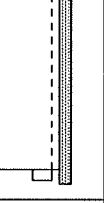
Mounting Method					
Standard Mounting:A					
Input Voltage	115VAC				
Output Voltage	5VDC				
Output Current	37.5A(75%)				

(2) Measuring Results

Output Derating		Temperature Rise (°C)				
		Io=75 %				
		Ta=60°C	Ta=60°C	Ta=60°C	Ta=60°C	Ta=60°C
Location No.	Part name	Mounting A	Mounting B	Mounting C	Mounting D	Mounting E
A101	CHIP IC	45	39	44	44	40
A102	CHIP IC	49	42	47	45	44
A201	CHIP IC	32	27	36	38	25
C1	E.CAP.	33	26	28	29	29
C52	E.CAP.	27	26	29	33	22
C53	E.CAP.	28	27	31	36	24
C54	E.CAP.	30	28	32	35	24
D1	BRIDGE DIODE	53	50	55	54	47
D2	S.B.D	51	45	53	53	46
D3	F.R.D	50	45	48	47	44
Q1	MOSFET	55	49	56	55	49
Q2	MOSFET	53	48	53	52	47
Q3	MOSFET	49	44	48	47	34
Q52	MOSFET	46	41	47	46	39
Q53	MOSFET	47	41	47	47	39
Q104	CHIP MOSFET	54	50	55	54	48
Q201	CHIP MOSFET	55	52	56	57	49
L3	BALUN COIL	31	33	38	42	26
L4	BALUN COIL	36	40	44	47	33
L5	CHOKE COIL	53	53	52	59	47
L51	CHOKE COIL	40	39	40	43	35
T1 WIRE	TRANSFORMER WIRE	42	41	46	47	20
T2 WIRE	TRANSFORMER WIRE	43	36	39	38	41
PC101	PHOTO COUPLER	44	38	45	43	38
PC102	PHOTO COUPLER	44	37	44	43	37

## 3. Main Components Temperature Rise List

MODEL : CUS250LD-5

## (1) Measuring Conditions

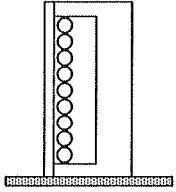
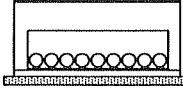
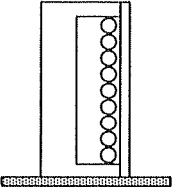
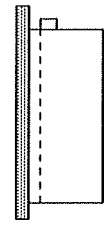
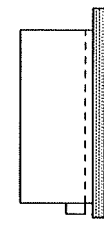
Mounting Method	Mounting A	Mounting B	Mounting C	Mounting D	Mounting E
Standard Mounting:A					
Input Voltage	115VAC				
Output Voltage	5VDC				
Output Current	25A(50%)				

## (2) Measuring Results

Output Derating		Temperature Rise (°C)				
		Io=50 %				
		Ta=70°C	Ta=70°C	Ta=70°C	Ta=70°C	Ta=70°C
Location No.	Part name	Mounting A	Mounting B	Mounting C	Mounting D	Mounting E
A101	CHIP IC	34	31	34	34	32
A102	CHIP IC	38	34	37	36	36
A201	CHIP IC	22	20	26	28	19
C1	E.CAP.	24	21	22	22	23
C52	E.CAP.	18	19	21	24	16
C53	E.CAP.	19	20	22	26	17
C54	E.CAP.	20	20	22	25	17
D1	BRIDGE DIODE	37	36	40	39	34
D2	S.B.D	34	32	38	37	32
D3	F.R.D	36	34	36	36	33
Q1	MOSFET	38	35	40	39	35
Q2	MOSFET	38	36	39	39	35
Q3	MOSFET	34	32	34	34	25
Q52	MOSFET	32	30	33	33	28
Q53	MOSFET	31	29	33	33	27
Q104	CHIP MOSFET	41	39	42	42	38
Q201	CHIP MOSFET	41	40	43	44	38
L3	BALUN COIL	19	22	26	28	17
L4	BALUN COIL	24	27	30	33	24
L5	CHOKE COIL	46	47	45	52	42
L51	CHOKE COIL	29	29	29	32	26
T1 WIRE	TRANSFORMER WIRE	30	31	34	35	14
T2 WIRE	TRANSFORMER WIRE	34	30	30	31	32
PC101	PHOTO COUPLER	33	30	34	34	29
PC102	PHOTO COUPLER	33	29	34	33	29

3. Main Components Temperature Rise List

MODEL : CUS250LD-5

(1) Measuring Conditions

Mounting Method	Mounting A	Mounting B	Mounting C	Mounting D	Mounting E
Standard Mounting: A					
Input Voltage	230VAC				
Output Voltage	5VDC				
Output Current	50A(100%)				

(2) Measuring Results

Output Derating		Temperature Rise (°C)				
		Io=100 %				
		Ta=40°C	Ta=40°C	Ta=40°C	Ta=40°C	Ta=40°C
Location No.	Part name	Mounting A	Mounting B	Mounting C	Mounting D	Mounting E
A101	CHIP IC	47	40	46	46	44
A102	CHIP IC	53	43	52	49	50
A201	CHIP IC	37	32	42	43	31
C1	E.CAP.	31	26	29	28	28
C52	E.CAP.	39	38	39	42	32
C53	E.CAP.	38	38	39	44	33
C54	E.CAP.	38	36	37	40	30
D1	BRIDGE DIODE	50	45	52	50	44
D2	S.B.D	52	44	54	50	47
D3	F.R.D	59	51	59	55	56
Q1	MOSFET	50	43	52	49	45
Q2	MOSFET	65	57	65	63	59
Q3	MOSFET	61	54	61	59	56
Q52	MOSFET	57	50	57	55	50
Q53	MOSFET	59	52	59	58	51
Q104	CHIP MOSFET	64	57	64	62	59
Q201	CHIP MOSFET	67	62	68	68	61
L3	BALUN COIL	28	29	37	37	23
L4	BALUN COIL	32	34	40	40	27
L5	CHOKE COIL	52	48	51	53	46
L51	CHOKE COIL	52	49	50	54	45
T1 WIRE	TRANSFORMER WIRE	56	54	55	55	47
T2 WIRE	TRANSFORMER WIRE	47	37	46	43	49
PC101	PHOTO COUPLER	48	39	50	47	43
PC102	PHOTO COUPLER	47	37	49	46	42

4. Electrolytic capacitor life time

MODEL : CUS250LD-5

Mounting A

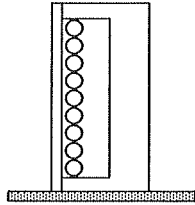

Conditions Ta 40°C -----  
 50°C -.-.-.-  
 60°C \_\_\_\_\_  
 70°C -.-.-.-

Vin = 115VAC

Load (%)	Lifetime (years)			
	Ta = 40°C	Ta = 50°C	Ta = 60°C	Ta = 70°C
50	10.0	10.0	7.5	3.8
75	10.0	7.4	3.7	-
90	8.6	4.3	-	-
100	6.2	-	-	-

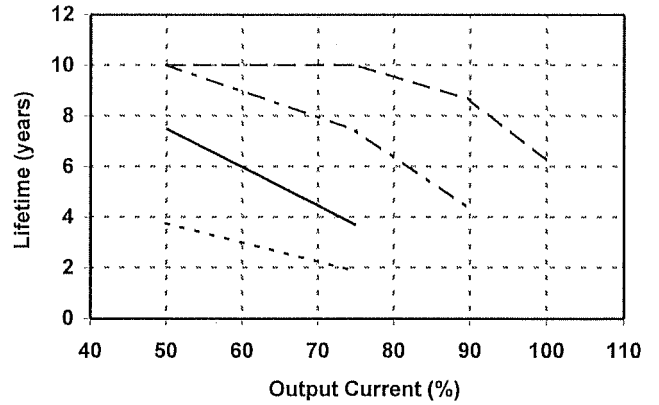

Vin = 230VAC

Load (%)	Lifetime (years)			
	Ta = 40°C	Ta = 50°C	Ta = 60°C	Ta = 70°C
50	10.0	10.0	7.9	3.9
75	10.0	8.8	4.4	-
90	10.0	5.7	-	-
100	8.1	-	-	-

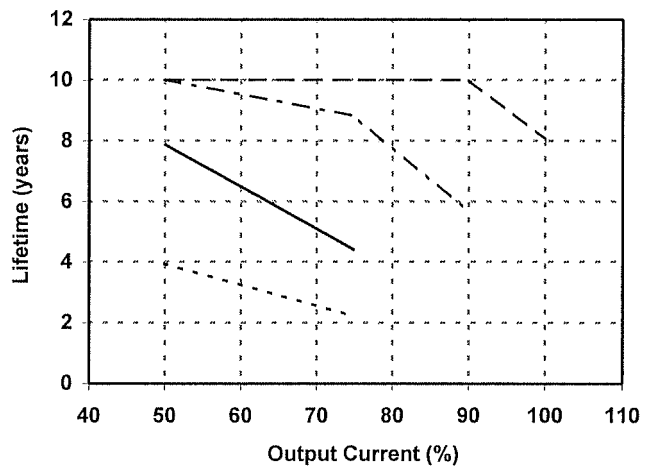

Formula:

For 105°C Elect. capacitor

$$L = L_o * 2^{(105-\Delta T-T_a)/10} / (24 * 365) \text{ (years)}$$

Where:

- L — Elec. Capacitor computed life (24 hours per day , 365 days operation)
- L<sub>o</sub> — Guarantee life for Elec. capacitor
- T<sub>a</sub> — Ambient temperature
- ΔT — Temperature rise of Elec. capacitor

4. Electrolytic capacitor life time

MODEL : CUS250LD-5

Mounting B

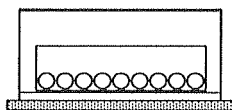

Vin = 115VAC

Load (%)	Lifetime (years)			
	Ta = 40°C	Ta = 50°C	Ta = 60°C	Ta = 70°C
50	10.0	10.0	7.5	3.8
75	10.0	8.5	4.2	-
90	10.0	5.3	-	-
100	6.1	-	-	-

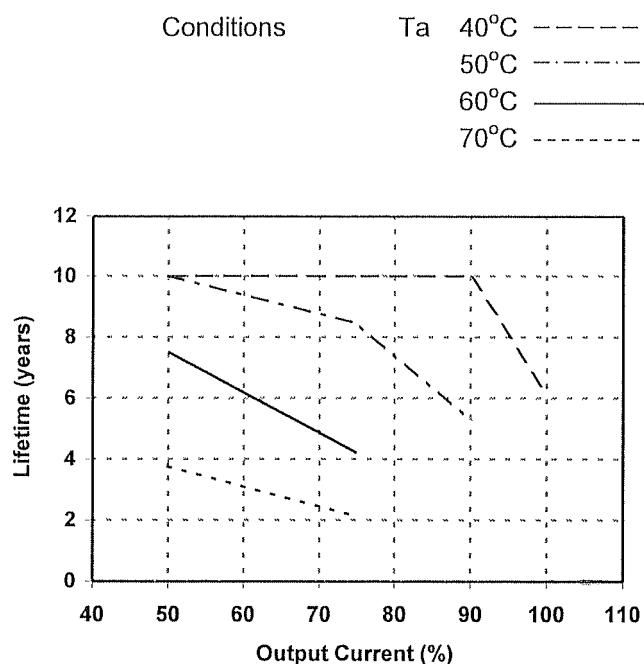

Vin = 230VAC

Load (%)	Lifetime (years)			
	Ta = 40°C	Ta = 50°C	Ta = 60°C	Ta = 70°C
50	10.0	10.0	8.2	4.1
75	10.0	8.9	4.5	-
90	10.0	5.9	-	-
100	8.5	-	-	-

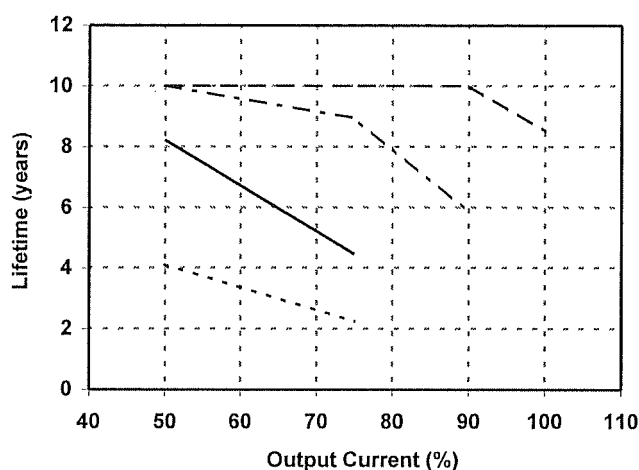

Formula:

For 105°C Elect. capacitor

$$L = L_0 * 2^{(105 - \Delta T - T_a) / 10} / (24 * 365) \text{ (years)}$$

Where:

- L — Elec. Capacitor computed life (24 hours per day , 365 days operation)
- L<sub>0</sub> — Guarantee life for Elec. capacitor
- T<sub>a</sub> — Ambient temperature
- ΔT — Temperature rise of Elec. capacitor

4. Electrolytic capacitor life time

MODEL : CUS250LD-5

Mounting C

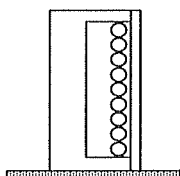

Conditions Ta 40°C -----  
 50°C -.-.-.-.  
 60°C \_\_\_\_\_  
 70°C -.-.-.-.

Vin = 115VAC

Load (%)	Lifetime (years)			
	Ta = 40°C	Ta = 50°C	Ta = 60°C	Ta = 70°C
50	10.0	10.0	6.6	3.3
75	10.0	6.8	3.4	-
90	9.4	4.7	-	-
100	8.3	-	-	-

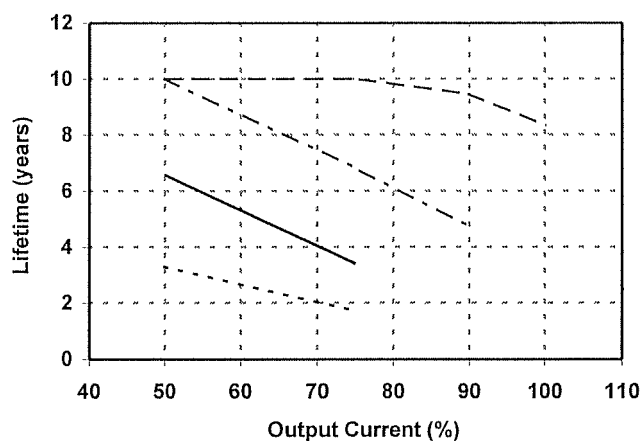

Vin = 230VAC

Load (%)	Lifetime (years)			
	Ta = 40°C	Ta = 50°C	Ta = 60°C	Ta = 70°C
50	10.0	10.0	8.1	4.0
75	10.0	9.1	4.5	-
90	10.0	6.0	-	-
100	7.3	-	-	-

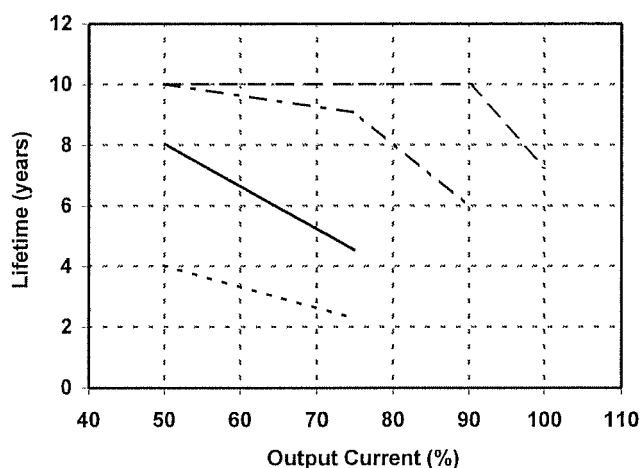

Formula:

For 105°C Elect. capacitor

$$L = L_o * 2^{(105-\Delta T-T_a)/10} / (24 * 365) \text{ (years)}$$

Where:

- L — Elec. Capacitor computed life (24 hours per day , 365 days operation)
- L<sub>o</sub> — Guarantee life for Elec. capacitor
- T<sub>a</sub> — Ambient temperature
- ΔT — Temperature rise of Elec. capacitor

4. Electrolytic capacitor life time

MODEL : CUS250LD-5

Mounting D

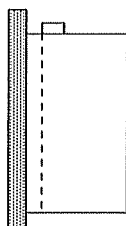

Vin = 115VAC

Load (%)	Lifetime (years)			
	Ta = 40°C	Ta = 50°C	Ta = 60°C	Ta = 70°C
50	10.0	9.9	5.0	2.5
75	9.7	4.9	2.4	-
90	5.5	2.5	-	-
100	3.1	-	-	-

Conditions Ta 40°C -----  
 50°C - - - - -  
 60°C \_\_\_\_\_  
 70°C - - - - -

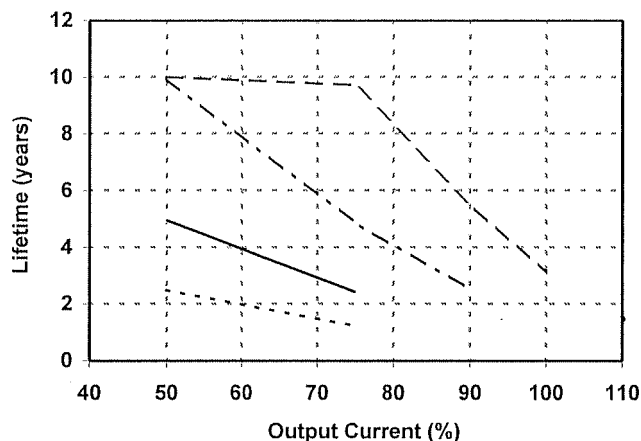

Vin = 230VAC

Load (%)	Lifetime (years)			
	Ta = 40°C	Ta = 50°C	Ta = 60°C	Ta = 70°C
50	10.0	10.0	6.4	3.2
75	10.0	6.6	3.3	-
90	8.1	4.1	-	-
100	5.6	-	-	-

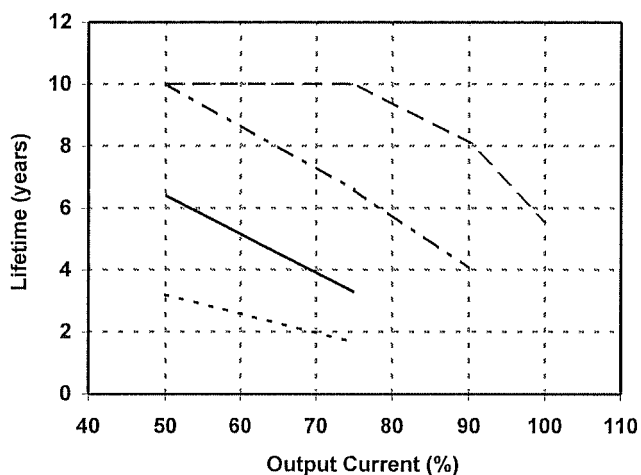

Formula:

For 105°C Elect. capacitor

$$L = L_0 * 2^{(105-\Delta T-T_a)/10} / (24 * 365) \text{ (years)}$$

Where:

- L — Elec. Capacitor computed life (24 hours per day , 365 days operation)
- L<sub>0</sub> — Guarantee life for Elec. capacitor
- T<sub>a</sub> — Ambient temperature
- ΔT — Temperature rise of Elec. capacitor

4. Electrolytic capacitor life time

MODEL : CUS250LD-5

Mounting E

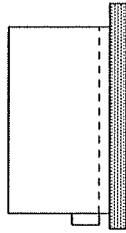

Conditions

Ta 40°C -----  
 50°C -.-.-.-.  
 60°C \_\_\_\_\_  
 70°C -.-.-.-.

Vin = 115VAC

Load (%)	Lifetime (years)			
	Ta = 40°C	Ta = 50°C	Ta = 60°C	Ta = 70°C
50	10.0	10.0	7.9	4.0
75	10.0	10.0	5.3	-
90	7.6	3.8	-	-
100	6.2	-	-	-

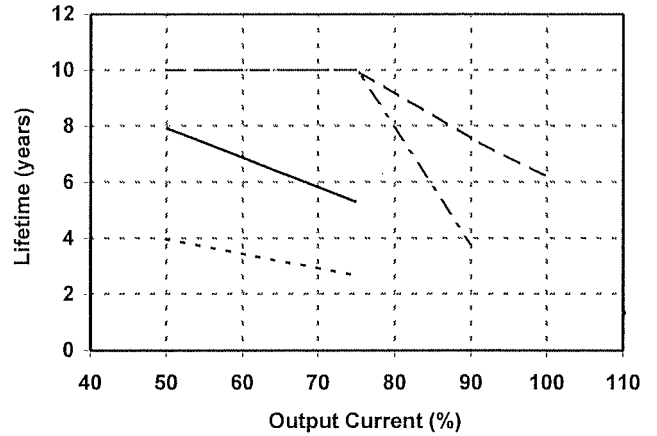

Vin = 230VAC

Load (%)	Lifetime (years)			
	Ta = 40°C	Ta = 50°C	Ta = 60°C	Ta = 70°C
50	10.0	10.0	9.7	4.9
75	10.0	10.0	6.1	-
90	10.0	8.5	-	-
100	10.0	-	-	-

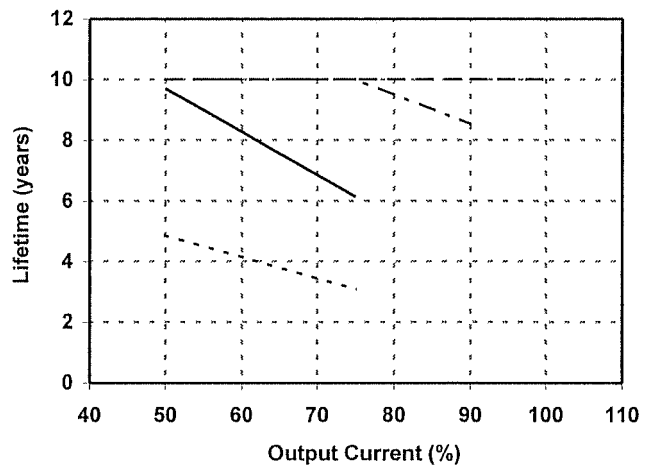

Formula:

For 105°C Elect. capacitor

$$L = L_o * 2^{(105-\Delta T-T_a)/10} / (24 * 365) \text{ (years)}$$

Where:

- L — Elec. Capacitor computed life (24 hours per day , 365 days operation)
- L<sub>o</sub> — Guarantee life for Elec. capacitor
- T<sub>a</sub> — Ambient temperature
- ΔT — Temperature rise of Elec. capacitor



**5. Vibration Test**

**MODEL : CUS250LD-5**

**(1) Vibration Test Class**

Frequency Variable Endurance Test

**(2) Equipment Used**

- Controller : DP550 (DP CORP. USA)
- Vibrator : V870 (LDS CORP. UK)

**(3) Test Conditions**

- Sweep frequency            10 ~ 55Hz
- Sweep time                    1.0 min.
- Acceleration                 Constant 19.6m/s<sup>2</sup> ( 2G )
- Direction                        X, Y, Z.
- Test time                        1 hour each

**(4) Test Method**

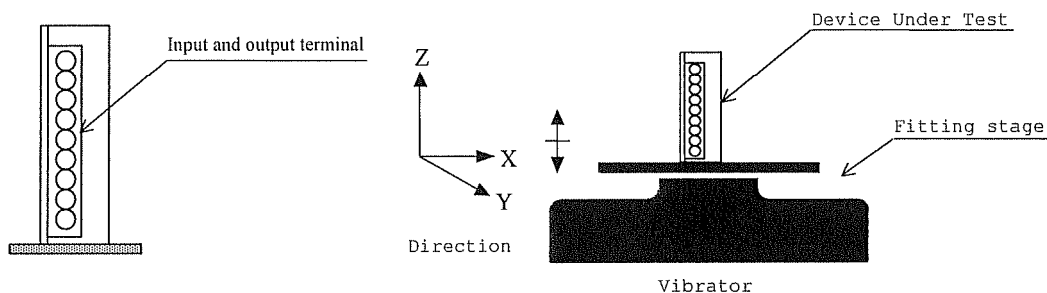

**(5) Test Results**

**OK**

V<sub>in</sub> : 115VAC

I<sub>out</sub> : 100%

Check item		Output Voltage (V)	Ripple Voltage (mVp-p)	D.U.T.State
Before Test		4.998	55	————
After Test	X	4.997	56	OK
	Y	4.997	56	OK
	Z	4.997	57	OK

**6. Shock test**

**MODEL : CUS250LD-5**

**(1) Shock Test Class**

- 196.1m/s<sup>2</sup> ( 20G ) (JIS-C-0040-1987)

**(2) Equipment Used**

- Equipment : S-015(Northwest machine)

**(3) Test Conditions**

- Acceleration                      Constant 196.1m/s<sup>2</sup> ( 20G )
- Direction                              X, Y, Z.
- Test time                                3 times

**(4) Test Method**

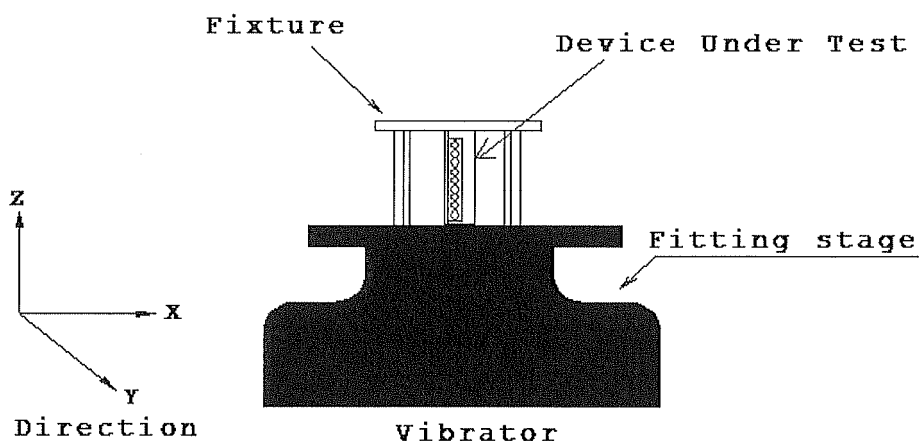

**(5) Test Results**

**OK**

Vin : 115VAC

Iout : 100%

Check item		Output Voltage (V)	Ripple Voltage (mVp-p)	D.U.T.State
Before Test		4.998	55	—————
After Test	X	4.997	56	OK
	Y	4.997	57	OK
	Z	4.997	57	OK

## 7. Noise simulate test

MODEL : CUS250LD-5

### (1) Test circuit and equipment

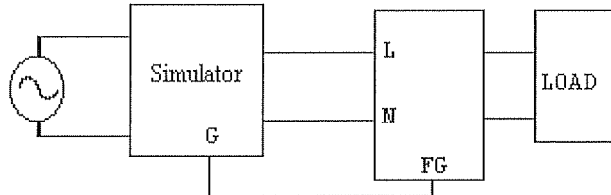

Simulator : INS-400L Noise Laboratory Co.,LTD

### (2) Test conditions

- |                       |                 |                  |                  |
|-----------------------|-----------------|------------------|------------------|
| • Input voltage       | : 115VAC/230VAC | • Noise level    | : 0V~2.0kV       |
| • Output voltage      | : Rated         | • Phase shift    | : 0° ~ 360°      |
| • Output current      | : 0%, 100%      | • Polarity       | : + , -          |
| • Ambient temperature | : 25°C          | • Mode           | : Normal, Common |
| • Pulse width         | : 50ns ~ 1000ns | • Trigger select | : Line           |

### (3) Acceptable conditions

1. Not to be broken.
2. Not to be shut down output.
3. No other out of orders.

### (4) Test result

OK

**8. Thermal shock test**

MODEL : CUS250LD-5

**(1) Equipment used**

THERMAL SHOCK CHAMBER TSA-101S-W (ESPEC CORP.)

**(2) The number of D.U.T.(Device Under Test)**

1 unit

**(3) Test Conditions**

- Ambient temperature : -40°C ↔ 85°C
- Test time : Refer to drawing
- Test cycle : 100 cycles
- Not operating : NO

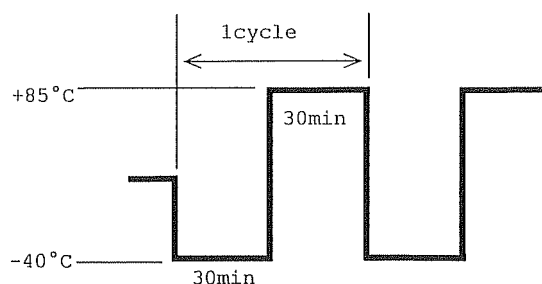

**(4) Test Method**

Before testing, check if there is no abnormal output, then put the D.U.T. in testing chamber, and test it according to the above cycle. 100 cycles later, leave it for 1 hour at the room temperature, then check if there is no abnormal output.

**(5) Test Results**

OK

Vin : 115VAC			5V			
Io : 100%			From	To		
Ripple&Noise		mV	50	50		
Line regulation	Full load	mV	1	1		
Load regulation	Vin:115V	mV	18	18		
Efficiency	Pin	W	285.93	88.02%	285.93	88.02%
	Vout	V	5.034		5.034	
	Iout	A	50		50	
Solder condition • etc.			OK			