

ROYALOHM

C O N F I D E N T I A L D O C U M E N T

SPECIFICATION FOR APPROVAL

CONRAD

Description : (MFR) Coated Type Kit Resistors
100pcs./polybag kit

Royalohm Part no.:
MF0W4FxxxxxKIT

Approved by

Parts corresponding to RoHS Compliant: 2005-Apr.-1

Royal Electronic Factory (Thailand) Co., Ltd.
20/1-2 Moo 2 Klong-Na, Muang
Chachoengsao 24000, Thailand
Tel: +66-38-822404-8
Fax: +66 38-981190 / 823765
E-mail Address: Export sales: Export@royalohm.com
Local sales: Local@royalohm.com
<http://www.royalohm.com>
P.O. Box 251 Klongchan, Bangkok 10240, Thailand

Approved	Checked	Prepared
Mr. Jack Lin	Mr. S. Polthanasan	Ms. P. Supatta

Issued Date: 2014/01/14

Customer: CONRAD	Part No.: MF0W4FxxxxxKIT
-------------------------	---------------------------------

1. Scope:

This specification for approval relates to Coated Type Kit Resistors (MFR) manufactured by ROYALOHM 's specifications.

2. Type designation:

The type designation shall be in the following form :

(Ex.)	MF	1/4W	F	4.99KΩ
	Type	Power Rating	Resistance Tolerance	Nominal Resistance

3. Ratings:

Ratings shall be shown in the table 1.

Table 1

Type	MF
Rated Power	0.25W at 70°C
Max. Working Voltage	250 V
Max. Overload Voltage	500 V
Dielectric Withstanding Voltage	500 V
Rated Ambient Temp.	70 °C
Operating Temp. Range	-55°C --- +155°C
Resistance Tolerance	± 1%
Resistance Range	1Ω----10MΩ

3.1 Power rating:

Resistors shall have a power rating based on continuous full load operation at an ambient temperature of 70 °C. For temperature in excess of 70 °C , the load shall be derated as shown in the figure 1.

3.2 Voltage rating:

Resistors shall have a rated direct-current (DC) continuous working voltage or an approximate sine-wave root-mean-square (RMS) alternating-current (AC) continuous working voltage at commercial-line frequency and waveform corresponding to the power rating , as determined from the following formula :

$$RCWV = \sqrt{P \times R}$$

Were : RCWV = Rated DC or RMS AC continuous working voltage at commercial-line frequency and waveform (volt)

P = Power Rating (watt)

R = Nominal Resistance (ohm)

Coated Type Kit Resistors (MFR)

In no case shall the rated DC or RMS AC continuous working voltage be greater than the applicable maximum value

Figure 1.

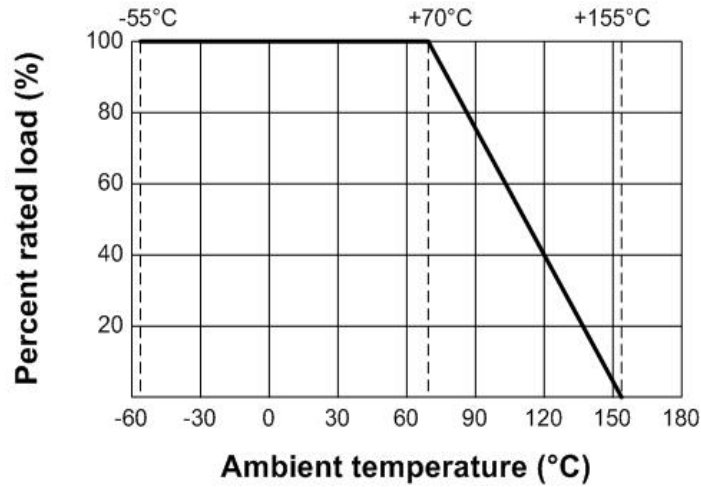

3.3 Nominal resistance :

Effective figures of nominal resistance shall be in accordance with E-96, E-192 series, and resistance tolerance shall be shown by table 1.

4. Construction :

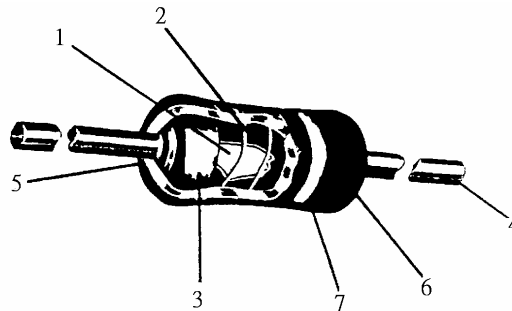

No.	Name	Material
1	Basic Body	Rod Type Ceramics
2	Resistance Film	Metal Film
3	End Cap	Steel (Tin plated iron surface)
4	Lead Wire	Annealed copper wire coated with tin
5	Joint	By Welding
6	Coating	Insulated epoxy resin (Color : Sky blue)
7	Color Code	Epoxy Resin

Coated Type Kit Resistors (MFR)

5. Characteristics :

Characteristics	Limits	Test Methods (JIS C 5201-1)
DC. resistance	Must be within the specified tolerance	The limit of error of measuring apparatus shall not exceed allowable range or 1% of resistance tolerance (Sub-clause 4.5)
Insulation resistance	Insulation resistance is 10,000 M Ω Min	Resistors shall be clamped in the trough of a 90° metallic V-block or foil method use a metal foil shall be wrapped closely around the body of the resistor. After that shall be tested at DC potential respectively specified in the above list for 60 +10/-0 secs. (Sub-clause 4.6)
Dielectric withstanding voltage	No evidence of flashover mechanical damage, arcing or insulation break down	Resistors shall be clamped in the trough of a 90° metallic V-block or foil method use a metal foil shall be wrapped closely around the body of the resistor. After that shall be tested at AC potential respectively specified in the table 1. for 60 +10/-0 secs. (Sub-clause 4.7)
Temperature coefficient	Within the temperature coefficient specified below : 10 Ω to 1M Ω ; \pm 50 PPM/ $^{\circ}$ C Max. 1 Ω to 9.76 Ω ; \pm 200 PPM/ $^{\circ}$ C Max.	Natural resistance change per temp. degree centigrade $\frac{R_2 - R_1}{R_1(t_2 - t_1)} \times 10^6 \quad (\text{PPM}/^{\circ}\text{C})$ R1: Resistance value at room temperature (t1) R2: Resistance value at room temp. plus 100 $^{\circ}$ C (t2) (Sub-clause 4.8)
Short time overload	Resistance change rate is \pm (0.5% + 0.05 Ω) Max. with no evidence of mechanical damage	Permanent resistance change after the application of a potential of 2.5 times RCWV for 5 seconds (Sub-clause 4.13)
Terminal strength	No evidence of mechanical damage	Direct load : Resistance to a 2.5 kgs direct load for 10 secs. in the direction of the longitudinal axis of the terminal leads Twist test : Terminal leads shall be bent through 90 $^{\circ}$ at a point of about 6mm from the body of the resistor and shall be rotated through 360 $^{\circ}$ about the original axis of the bent terminal in alternating direction for a total of 3 rotations (Sub-clause 4.16)
Solderability	95 % coverage Min.	The area covered with a new, smooth, clean, shiny and continuous surface free from concentrated pinholes. Test temp. of solder : 245 $^{\circ}$ C \pm 3 $^{\circ}$ C Dwell time in solder : 2 ~ 3 seconds (Sub-clause 4.17)

Coated Type Kit Resistors (MFR)																	
Characteristics	Limits	Test Methods (JIS C 5201-1)															
Soldering temp. reference	Electrical characteristics shall be satisfied. Without distinct deformation in appearance. (95 % coverage Min.)	The leads immersed into solder bath to 3.2 to 4.8 mm. from the body. Permanent resistance change shall be checked. <u>Wave soldering condition: (2 cycles Max.)</u> Pre-heat : 100 ~ 120 °C , 30 ± 5 sec. Suggestion solder temp.: 235 ~ 255 °C , 10 sec. (Max.) Peak temp.: 260 °C <u>Hand soldering condition:</u> Hand Soldering bit temp. : 380 ± 10 °C Dwell time in solder : 3 +1/-0 sec.															
Resistance to soldering heat	Resistance change rate is ± (1% + 0.05 Ω) Max. with no evidence of mechanical damage	Permanent resistance change when leads immersed to 3.2 to 4.8 mm from the body in 350°C ± 10 °C solder for 3 ± 0.5 seconds (Sub-clause 4.18)															
Temperature cycling	Resistance change rate is ± (1% + 0.05 Ω) Max. with no evidence of mechanical damage	Resistance change after continuous 5 cycles for duty shown below:															
		<table border="1" style="width: 100%; border-collapse: collapse;"> <thead> <tr> <th style="text-align: center;">Step</th> <th style="text-align: center;">Temperature</th> <th style="text-align: center;">Time</th> </tr> </thead> <tbody> <tr> <td style="text-align: center;">1</td> <td style="text-align: center;">-55°C ± 3°C</td> <td style="text-align: center;">30 mins</td> </tr> <tr> <td style="text-align: center;">2</td> <td style="text-align: center;">Room temp.</td> <td style="text-align: center;">10~15 mins</td> </tr> <tr> <td style="text-align: center;">3</td> <td style="text-align: center;">+155°C ± 2°C</td> <td style="text-align: center;">30 mins</td> </tr> <tr> <td style="text-align: center;">4</td> <td style="text-align: center;">Room temp.</td> <td style="text-align: center;">10~15 mins</td> </tr> </tbody> </table>	Step	Temperature	Time	1	-55°C ± 3°C	30 mins	2	Room temp.	10~15 mins	3	+155°C ± 2°C	30 mins	4	Room temp.	10~15 mins
		Step	Temperature	Time													
		1	-55°C ± 3°C	30 mins													
		2	Room temp.	10~15 mins													
3	+155°C ± 2°C	30 mins															
4	Room temp.	10~15 mins															
(Sub-clause 4.19)																	
Vibration	Resistance change rate is ± (1% + 0.05 Ω) Max.	55Hz, 3 planes 2hrs each Total amplitude = 1.5mm (Sub-clause 4.22)															
Load life in humidity	Resistance value	Δ R/R															
	Normal type	± 1.5 %															
	Resistance change after 1,000 hours (1.5 hours "on", 0.5 hour "off") at RCWV in a humidity test chamber controlled at 40 °C ± 2 °C and 90 to 95 % relative humidity (Sub-clause 4.24.2.1)																
Load life	Resistance value	Δ R/R															
	Normal type	± 1.5 %															
	7.10 Permanent resistance change after 1,000 hours operating at RCWV with duty cycle of (1.5 hours "on", 0.5 hour "off") at 70°C ± 2°C ambient (Sub-clause 4.25.1)																
Resistance to solvent	No deterioration of protective coatings and markings	Specimens shall be immersed in a bath of trichroethane completely for 3 minutes with ultrasonic (Sub-clause 4.30)															
Pulse overload	Resistance change rate is ± (1% + 0.05 Ω) Max. with no evidence of mechanical damage	Resistance change after 10,000 cycles (1 sec. "on" , 25 secs. "off") at 4 times RCWV (Sub-clause 5.8)															

Coated Type Kit Resistors (MFR)

6. Dimension :

Unit : mm

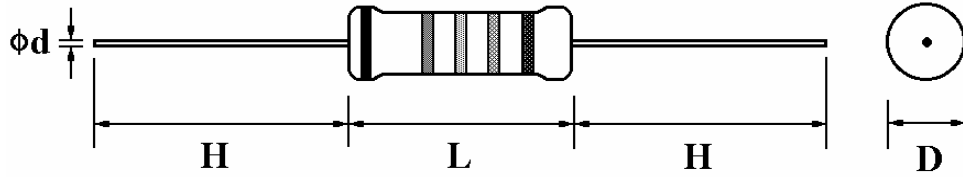

Type	Power Rating	D (Max.)	L (Max.)	d ± 0.05	H ± 3
MF	1/4W	2.5 mm	6.8 mm	0.54 mm	28 mm

Painting method:

Welding point, terminal and lead wire, is permissible to be exposed without the outer coated cover. The extent should be within 1/2 of the arc angle.

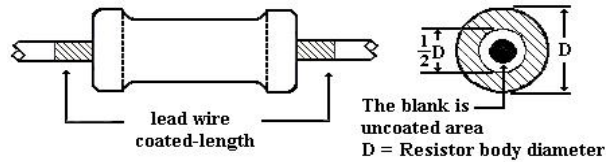

7. Marking :

7.1 Resistor :

Resistors shall be marked with color coding colors shall be in accordance with JIS C 0802

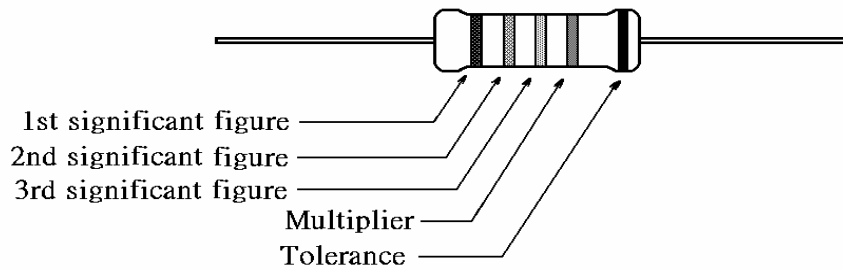

Coated Type Kit Resistors (MFR)

8. Packing specification :

8.1 Taping dimension :

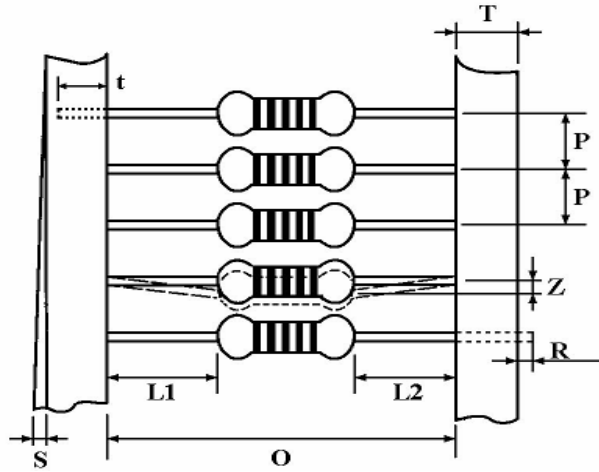

Dimensions (mm)

Type	Style	O	P	L1-L2	T	Z	R	t	S
MF-25	PT-52	52±1	5±0.3	1 Max.	6±1	1 Max.	0	4 ±1	0.5 Max.

8.2 Bulk in inner box packing (in plastic Bag)



100 pcs./polybag
255x0.08x72 (mm) LxHxW

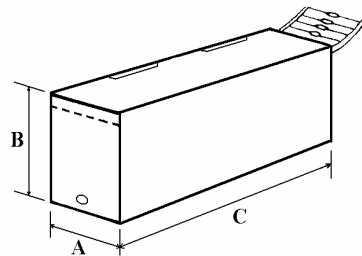

Inner Box of Plastic Bag. (3,000 pcs.)

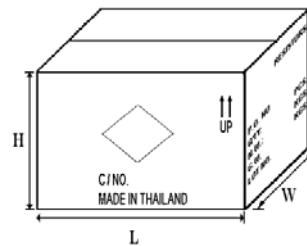

Carton Box (60,000 pcs.)

Dimension (mm)

Type	Q'ty / Bag (pcs.)	Q'ty / Inner Box (pcs.)	Q'ty / Carton (pcs.)	Inner Box Size L x W x H (±5)	Carton Box Size L x W x H (±5)
MF-25	100	3,000	60,000	262 x 84 x 79	270 x 460 x 350

Part Number System

Explanation of Part Number System (Coated Type Kit Resistors (MFR))

1	2	3	4	5	6	7	8	9	10	11	12	13	14
M	F	0	W	4	F	F	8	2	0	K	K	I	T

Product Type:
MF = Metal Film
Fixed Resistor

Special Feature:
0 = Standard Product
F = Non-Flame
I = Non-Inductive Product

Tolerance:
B = ± 0.1%
C = ± 0.25%
D = ± 0.5%
F = ± 1%
G = ± 2%
J = ± 5%

Resistance Value:
E-24 series: the 1st digit is "0",
the 2nd & 3rd digits are for
the significant figures of the
resistance and the 4th indicate
the number of zeros following:
"J" ~ 0.1, "K" ~ 0.01
Ex.: 4.7Ω ~ 47J, 4.7KΩ ~ 472
E--96 Series: the 1st to 3rd digits
are significant figures of
resistance and the fourth
one denotes number of zeros
following:
Ex.: 1.33KΩ = 1331

Wattage:

Normal size:	Small size:
W8 = 1/8W	S4 = 1/4W-S
W4 = 1/4W	S2 = 1/2W-S
W2 = 1/2W	O6 = 0.6W-S
1W = 1W	M7 = 0.75W-S
2W = 2W	1S = 1W-S
3W = 3W	2S = 2W-S
	3S = 3W-S

Extra Small size:
U2 = 1/2W-SS
04 = 0.4W-SS

PPM requirement:
B = ± 15PPM
C = ± 25PPM
F = ± 50PPM
G = ± 100PPM
J = ± 200PPM

Special Feature:
Fill-in these 3 digits
with the chip resistor
types as follows:
- KIT: Kit resistor
(with resistor)
- K0N: Album only
(no resistor)
- KIL: Index Only
- KIN: Insert Only
- KIC: Insert and
Album, Cover Lid
(no resistor)

Sample: MF 1/4W +/- 1% 50ppm 8.2Ω 100Pcs. Per Poly bag Resistors → MF0W4FF820KKIT

Coated Type Kit Resistors (MFR)

Environment Related Substance

This product complies to EU RoHS directive, EU PAHs directive, EU PFOS directive and Halogen free.

Ozone layer depleting substances.

Ozone depleting substances are not used in our manufacturing process of this product.

This product is not manufactured using Chloro fluorocarbons (CFCs), Hydrochlorofluorocarbons (HCFCs), Hydrobromofluorocarbons (HBFCs) or other ozone depleting substances in any phase of the manufacturing process.

Storage Condition

The performance of these products, including the solderability, is guaranteed for a year from the date of arrival at your company, provided that they remain packed as they were when delivered and stored at a temperature of $25^{\circ}\text{C} \pm 5^{\circ}\text{C}$ and a relative humidity of $60\%\text{RH} \pm 10\%\text{RH}$

Even within the above guarantee periods, do not store these products in the following conditions. Otherwise, their electrical performance and/or solderability may be deteriorated, and the packaging materials (e.g. taping materials) may be deformed or deteriorated, resulting in mounting failures.

1. In salty air or in air with a high concentration of corrosive gas, such as Cl_2 , H_2S , NH_3 , SO_2 , or NO_2
2. In direct sunlight