

Instruction Manual

MS5/4PIU-4 MS5/12PIU-5
 MS5/6PIU-4 MS5/16PIU-5
 MS5/8PIU-4

standalone Unicable™
 multiswitches for
 distribution of satellite
 signals from 1 satellite
 position (4 polarities) for
 8 users

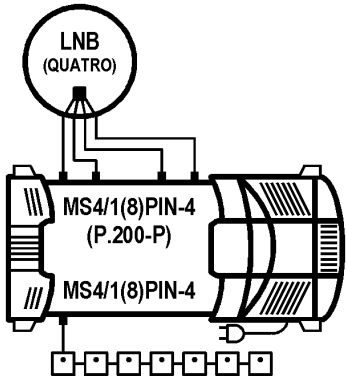

standalone Unicable™
 multiswitch for
 distribution of satellite
 signals from 2 satellite
 positions (8 polarities)
 for 8 users

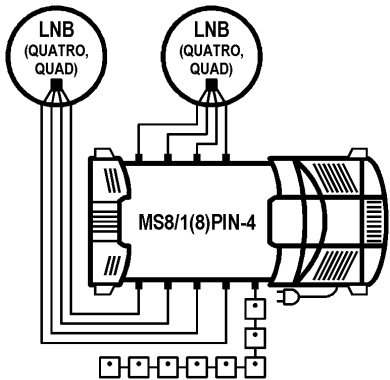

Dear Customer,
 congratulations on the purchase of the EMP-Centauri product. Before its installation and putting into operation, read carefully the entire operation manual. Keep the purchase and rework (if any) records for future need.

Content

1 Field of Application, Warranty	1
2 Technical Specifications	1
3 Product Takeover	3
4 Product Storing and Installations	3
5 Product Connection	3
6 Product Settings	4
7 Safety	4
8 Product Maintenance	5
9 Troubleshooting	5
10 Symbols Explanation	6
11 Wiring Diagrams	6
12 EMP-Centauri Related Products	7
13 Contact	8

1 Field of Application, Warranty

The product is designed for the distribution of satellite (SAT), terrestrial (TERR); TV and radio signals. **We recommend the device to be installed and serviced by the qualified technician.** EMP-Centauri's PROFI CLASS products are covered under 4 (four) years warranty from the date of purchase. The warranty shall not apply to the product used for other than the specified purpose. The user will be responsible for injury or material damage which may arise in consequence of any product use in contradiction with the manual. It is prohibited to dismantle the product and make any interventions in it. Repairs or any interventions in the product may be performed only by EMP-Centauri company, or other companies authorized by EMP-Centauri.

2 Technical Specifications

The products are standalone multiswitches for distribution of terrestrial and satellite signals from 1 satellite position (4 polarities) for 4 (MS5/4PIU-4), 6 (MS5/6PIU-4), 8 (MS5/8PIU-4), 12 (MS5/12PIU-5) or 16 (MS5/16PIU-5) users. Multiswitches are controlled from receiver by analogue commands. It is enabled to switch on active or passive mode of terrestrial band. Multiswitches are compatible with quad LNB. Terrestrial input can supply terrestrial antenna preamplifier with DC voltage, the supply is electronically protected against short-circuit. Multiswitches are powered from internal power supply PIU27.

13 Contact

EMP-Centauri s.r.o.
 5. května 690
 339 01 Klatovy 4
 Czech Republic

tel: (+420) 376 314 852
 fax: (+420) 376 314 367
 info@emp-centauri.cz
 www.emp-centauri.eu

Specification	MS5/4PIU-4	MS5/6PIU-4	MS5/8PIU-4	MS5/12PIU-5	MS5/16PIU-5
Number of Inputs	5				
Number of Outputs	4	6	8	12	16
Frequency Range	TERR 5-862 MHz (pas), 40-862 MHz (act), SAT 950-2300 MHz				
Insertion Loss (avg)	TERR 2/19 dB (act/pas), SAT 3 dB	TERR 3/20 dB (act/pas), SAT 4 dB		TERR 7gain/21 dB (act/pas), SAT 0 dB	TERR 6gain/22 dB (act/pas), SAT 0 dB
Isolation (min)	20 dB				
Maximum Input level*	TERR 93/100 dBuV (act/pas), SAT 100 dBuV			TERR 85/100 dBuV (act/pas), SAT 90 dBuV	
Maximum Output Level*	TERR 91/81 dBuV (act/pas), SAT 97 dBuV	TERR 90/80 dBuV (act/pas), SAT 96 dBuV		TERR 92/79 dBuV (act/pas), SAT 90 dBuV	TERR 91/78 dBuV (act/pas), SAT 90 dBuV
Control	analogue commands				
Current Consumption	40mA (18 V DC) from each satellite receiver, 240 mA / 18 V DC (act) or 160 mA / 18 V DC (pas) from power supply			45 mA (18 V DC) from each satellite receiver, 360 mA / 18 V DC (act) or 210 mA / 18 V DC (pas) from power supply	
Current from Terr. Input	100 mA max (12 V DC)				
Power Consumption	6.0 W / 4.0 W (act/pas) + consumption of devices connected to inputs (LNB, terrestrial antenna preamplifier, etc.), maximum consumption of multiswitch and connected devices must not exceed maximum output power of power supply			9.0 W / 5.0 W (act/pas) + consumption of devices connected to inputs (LNB, terrestrial antenna preamplifier, etc.), maximum consumption of multiswitch and connected devices must not exceed maximum output power of power supply	
Dimensions (w,d,h)	26.5 x 15.2 x 8.7			34.5 x 15.2 x 8.7	
Temperature Range	-30°C - +70°C				

* TERR: EN 50083-3/60dB IMA₃ [dBuV]; SAT: EN 50083-3/35dB IMA₃ [dBuV]

avg - average value, there is tolerance of ±3 dB in specified range

min - minimum value

act/pas - active/passive mode of terrestrial band

12 EMP-Centauri's PROFI CLASS Related Products

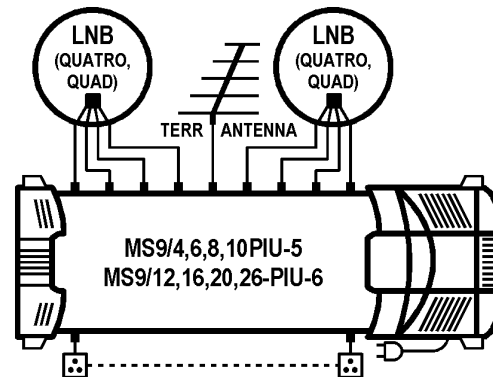

standalone multiswitches for distribution of terrestrial and satellite signals from 2 satellite positions (8 polarities) for 4-26 users

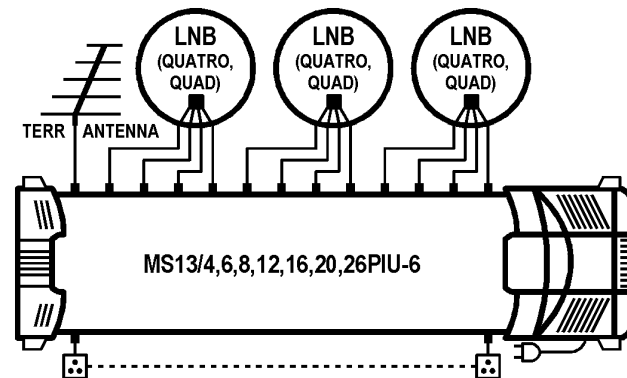

standalone multiswitches for distribution of terrestrial and satellite signals from 3 satellite positions (12 polarities) for 4-26 users

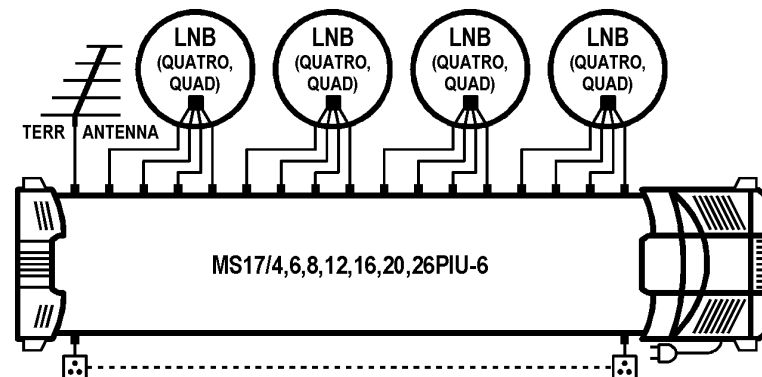









standalone multiswitches for distribution of terrestrial and satellite signals from 4 satellite positions (16 polarities) for 4-26 users

exceeds the specifications, see section 2 Product Specifications. The next cause can be the overheating of product in consequence of wrong installation, see section 4 Product Storing and Installation. Disconnect the product from the power grid, remove the cause, and re-plug the product into the power grid after a few minutes again.

If the failure cannot be removed, please contact your distributor.

10 Symbols Explanation

	certificate of conformity
	for indoor use only
	DC power supply
	grounding
	class II device
	fuse protected
	safety transformer
	According to EU directive, electric and electronic devices which are identified by one of the following symbols must not be disposed of together with municipal waste. When disposing of the old device, use local waste collection and separation systems.

11 Wiring Diagrams

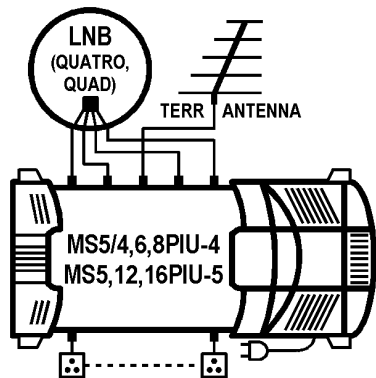

Power Supply Specifications	PIU15
Input Voltage	90-265 V AC, 50/60 Hz
Output Voltage	18 V DC
Maximum Output Current	0.8 A (18 V DC)
Maximum Output Power	15 W
Efficiency	75% min
Dimensions (w,d, h)	12.6 x 15.2 x 8.7 cm (power cord length 130 cm)
Temperature Range	-30 - +70 °C

3 Product Takeover

Make sure that the product is not damaged and following accessories are enclosed:

- 75 Ω loads for the impedance matching of unused outputs (2 pcs, others can be ordered from EMP-Centauri, code 1000066).

In the case of damage or missing accessories please contact your dealer.

4 Product Storing and Installation

The product must not be stored and installed

- in the place with excessive humidity,
- in the place with dropping or running water,
- in the place with high dust pollution, mechanical vibrations or impacts,
- in the place out of temperature limits specified in the section 2 Technical Specifications,
- close to heat sources (radiators or air ventilators, direct sunshine etc.),
- in the reach of children.

Fix the product firmly on a wall or another hard and inflammable surface with screws and dowels. **The mains socket must be placed near the product. The mains socket and plug must be easily available.**

- The product shall be in no case held only by the connected cables.
- Ensure the free space for the air circulation (space on sides and bellow the product should be at least 20 cm and the space over its top at least 50 cm).
- Do not cover the product (with curtains etc.).
- Do not place any containers with liquids (vases, glasses etc.) or naked flame sources (lighted candle etc.) on the product or near the product.

5 Product Connection

Connect the product in accordance with this manual and valid regulation. Use high-quality 75 Ω coaxial cable designed for satellite reception. Mount the F connectors (screw, crimp or compress type) on the ends of coaxial cables, in the case of using the screw F connectors proceed according to the following picture and instructions:



1. Remove the outer coaxial cable coating in the length of approx. 15 mm.
2. Roll up the metal shielding braid and the shielding foil underneath and cut the shielding with scissors to approx. 5 mm.
3. Remove approx. 10 mm of the inner plastic insulation (approx. 5 mm of the insulation remains in a place).

4. Carefully screw the F connector on the cable end until the plastic insulation levels with the F connector opening.
5. Check there is no short between the inner conductor of coaxial cable and F connector.

The coaxial cables shall not be broken, the minimum bending radius should be 5 cm. Connect the F connectors into the F sockets of product and fasten them with an appropriate force.

- Connect input F sockets marked A-D with convertor (LNB) outputs according to the next table:

marking of F socket of multiswitch	marking of outputs of quatro LNB	marking of outputs of quad LNB
A	V/L or 12V/0kHz	any output
B	H/L or 18V/0kHz	any output
C	V/H or 12V/22kHz	any output
D	H/H or 18V/22kHz	any output

- Connect input F socket marked TERR IN with output of terrestrial antenna, eventually with output of terrestrial antenna with terrestrial antenna preamplifier.
- Connect output F sockets marked 1 to actual number of outputs of multiswitch with other components in distribution system (satellite receiver, terrestrial receiver, wall socket etc.).
- Connect the mains plug into the mains socket with voltage according to section 2 Technical Specifications.
- Connect connector marked with grounding symbol with protective earthing conductor, see section 10 Symbols Explanation.

If some of outputs are not used, it is appropriate to terminate them with 75 Ohm loads. If not terminated, insertion loss curve in terrestrial band may be rippled.

The wiring examples are shown in the section 11 Wiring Diagrams or at the website www.emp-centauri.eu.

6 Product Settings

For all SAT inputs, it is possible to change level of signals by means of attenuators in 15 dB range; the minimum attenuation is in clockwise stop position, the maximum attenuation is in counterclockwise stop position (for terrestrial input switching to passive mode, see below). Set attenuators very gently, do not turn them behind stop positions by force.

Active and passive mode of terrestrial band can be selected by turnable switch, passive mode is selected by turning the switch to counterclockwise stop position. The return path is available in the passive mode.

If input F socket marked TERR IN is in short connection or maximal allowed current is exceeded (see section 2 Technical Specifications), the voltage decreases down to 0 V. Quality of signals is not affected however.

7 Safety

Due to security reasons the product and wiring in which the product is connected, must be grounded properly. Use the earthing terminal identified with the symbol of grounding to ground the product. Make sure the antennas are grounded properly.

Connect all devices to power grid only after all connections are finished and checked.

The product works with the AC voltage, see section 2 Technical Specifications. Make sure, that the local AC voltage corresponds to the operating voltage of product.

No objects can be placed on the mains cord for prevent its damage or break. No hot objects should touch the mains cord.

While disconnecting the product from power grid, never pull the mains cord but the mains plug to prevent the mains cord damage. Pay attention that the mains plug holds tight in the mains socket. Loose mains plug or mains socket means the danger of fire.

Never disassemble the product connected to the power grid, you risk the danger of electrical shock.

Never work on the wiring (including satellite and terrestrial receivers, TVs) during or before a storm. A lightning stroke into the antenna may cause dangerous overvoltage in the product metallic parts.

The product should be disconnected from the wiring immediately if it gets into contact with liquids (dropping water, spilled drinks etc.).

8 Product Maintenance

Always disconnect the product from the power grid and wiring before performing any maintenance of the product. If you have to enter places with a risk of fall, pay attention to your safety.

Use only dry cloth to clean the product and do not use any liquid agents.

Coaxial cables installed outdoors should be replaced once in a few years. Unscrew all F connectors and clean connector contacts, resp. shorten the coaxial cable by approx. 2 cm, every 2 years.

Check the state of power supply and its mains cord periodically. If the mains cord or the mains plug of product is damaged, it must be replaced by manufacturer or qualified technician to prevent any dangerous situation. Let the product serviced if the housing of power supply is damaged.

If not used for long time, disconnect the product from the power grid.

9 Troubleshooting

Always disconnect the product from the power grid before working on product, otherwise you risk the electric hazard. Pay attention to your safety if you have to enter places with a risk of fall.

In the case the product does not work and LED of power supply is on:

- Check if the terrestrial and satellite antennas are correctly fixed, optimally set and connected to the product, satellite and terrestrial receivers turned on, plugged on and correctly set.
- Check the connector connections. The inner conductor of coaxial cable must be in contact with the inner conductor of F socket and the shielding of coaxial cable with F connector. Replace broken or interrupted coaxial cable.

In the case the product does not work and LED of power supply is off or blinks:

- Check that the product is connected to the power grid with AC voltage. If not, connect the product to the power grid with correct AC voltage.
- Disconnect the product from the power grid and check that there is no short-circuit on the input satellite coaxial cables, which prevents the power supplying of LNBs. If yes, remove short-circuit and re-plug the product into the power grid again.
- The power supply can fail temporarily in case of overload or overheating. The cause can be current consumption of devices connected to the satellite inputs of product which