



airMAX™

TITANIUM SECTOR

Advanced RF Isolation Variable Beamwidth Antenna

Models: AM-V2G-Ti, AM-V5G-Ti, AM-M-V5G-Ti

Carrier-Class 2x2 MIMO PtMP BaseStation

Adjustable Beamwidth Configuration

Reduced Co-Location Interference



airMAX™ TITANIUM SECTOR

Advanced Carrier-Class PtMP Basestation Antenna

Introducing the airMAX Titanium Sector, which continues the evolution of Ubiquiti's best-in-class sector antennas. Advanced RF isolation and variable beamwidth configuration put the Titanium Sector at the forefront of sector antenna technology.

Reduced Co-Location Interference

Drawing on Ubiquiti's depth of electrical and mechanical engineering expertise, Ubiquiti has developed the airMAX Titanium Sector to be highly resistant to noise interference in co-location deployments.

Adjustable Beamwidth Configuration

Having adjustable beamwidth options enhances scalability and streamlines inventory. The airMAX Titanium Sector may be custom configured for any deployment requiring a 60°, 90°, or 120° sector.

Antenna gain changes according to the configured beamwidth.

Model	60°	90°	120°
AM-V2G-Ti	17 dBi	16 dBi	15 dBi
AM-V5G-Ti	21 dBi	20 dBi	19 dBi
AM-M-V5G-Ti	17 dBi	16 dBi	15 dBi

Increased Performance

The airMAX Titanium Sector was specifically engineered for optimal performance when paired with a Rocket™ Titanium.

- 20% increase in performance with PtMP networks
- Up to 90% performance improvement in a co-location environment
- Increased durability in harsh weather

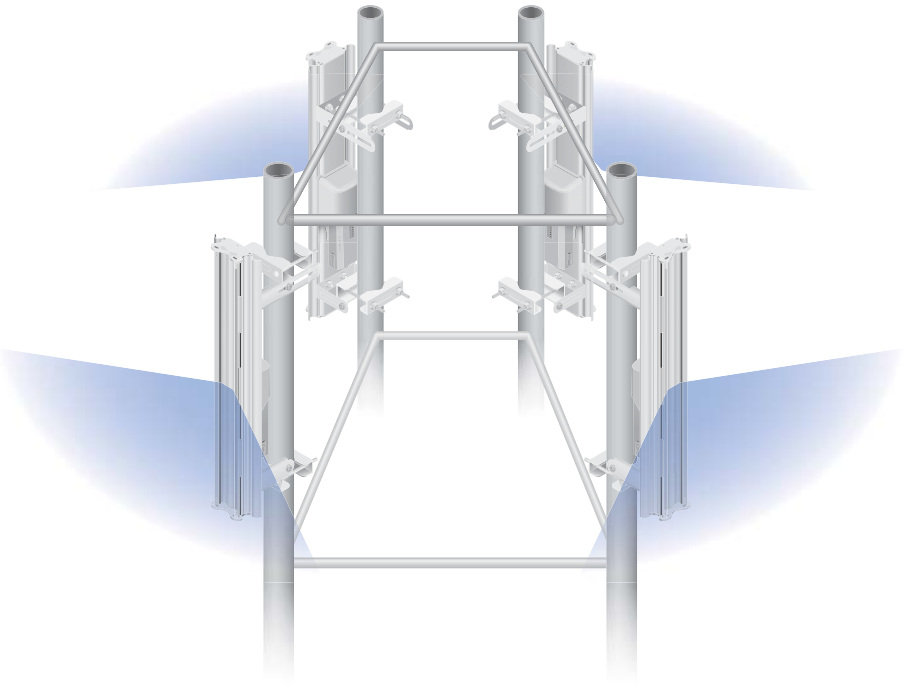

Ideal for Co-Location Deployments

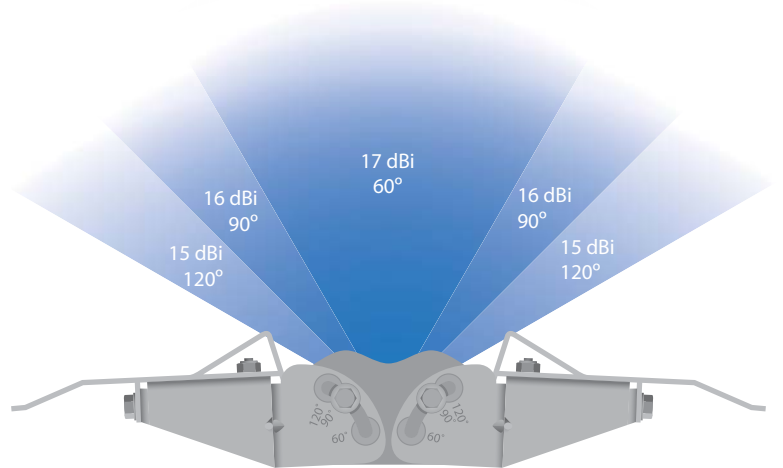

AM-V2G-Ti Adjustable Beamwidth

Easily Mount and Protect Your Rocket

The Titanium Sector has an integrated Rocket mount that allows you to mount the Rocket without the use of any tools. The custom-designed Protective Shroud helps to shield your Rocket from the elements.

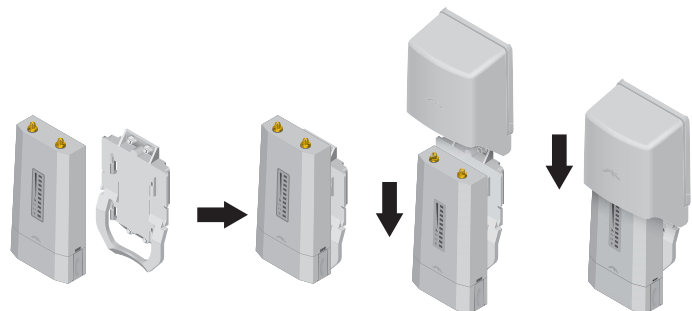

Overview

Model: AM-V2G-Ti

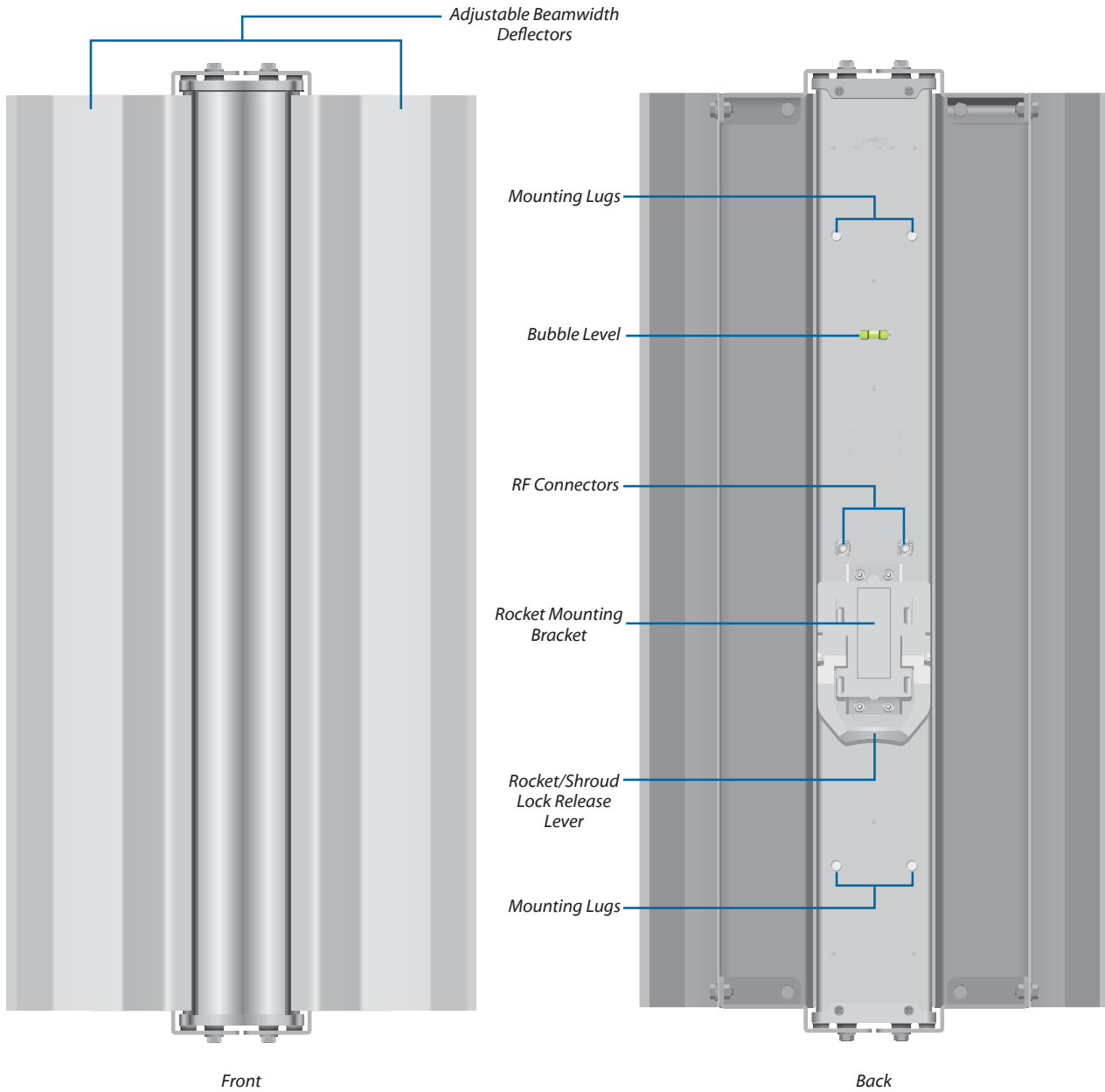

Model: AM-V5G-Ti

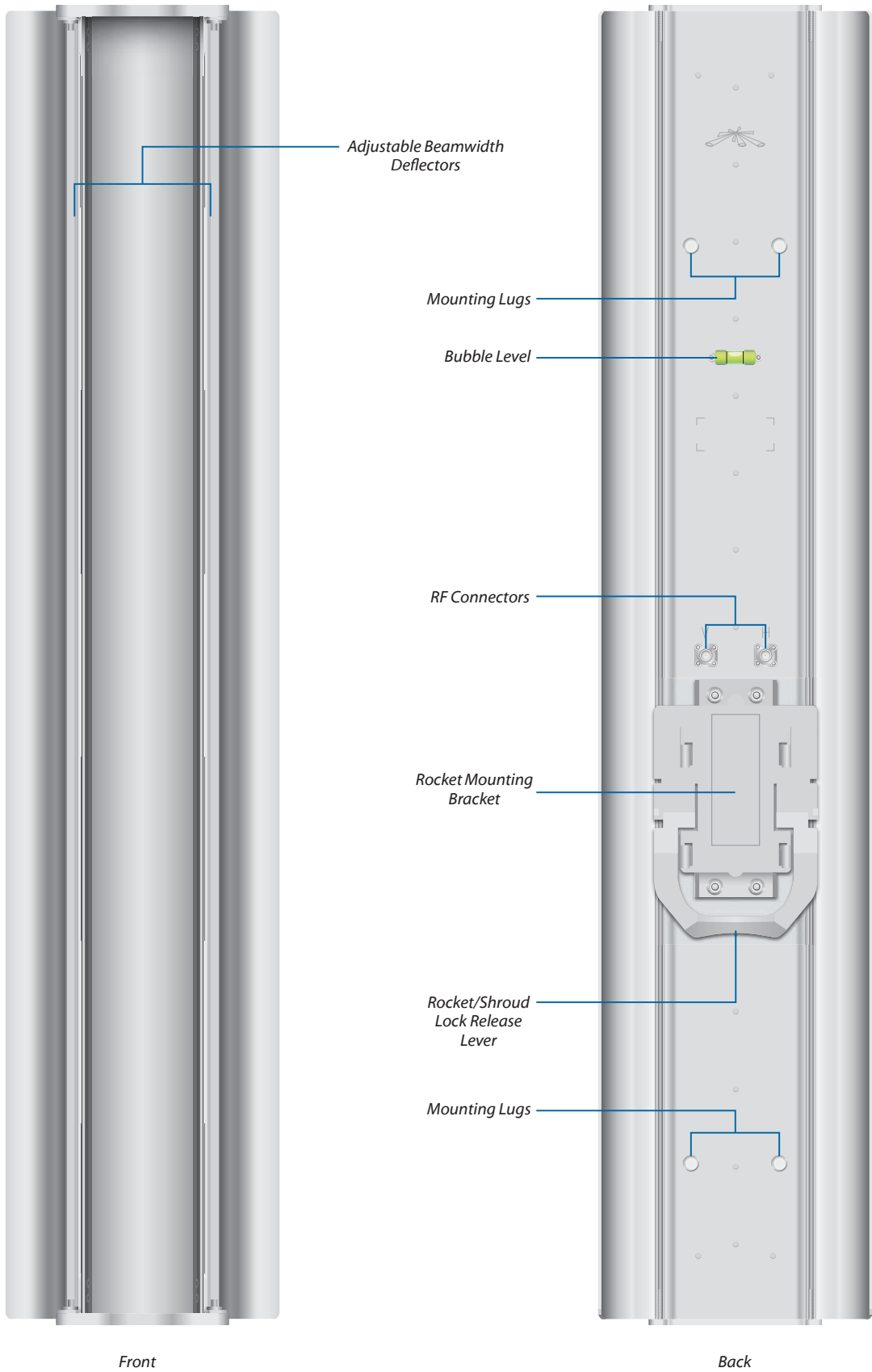

Model: AM-M-V5G-Ti

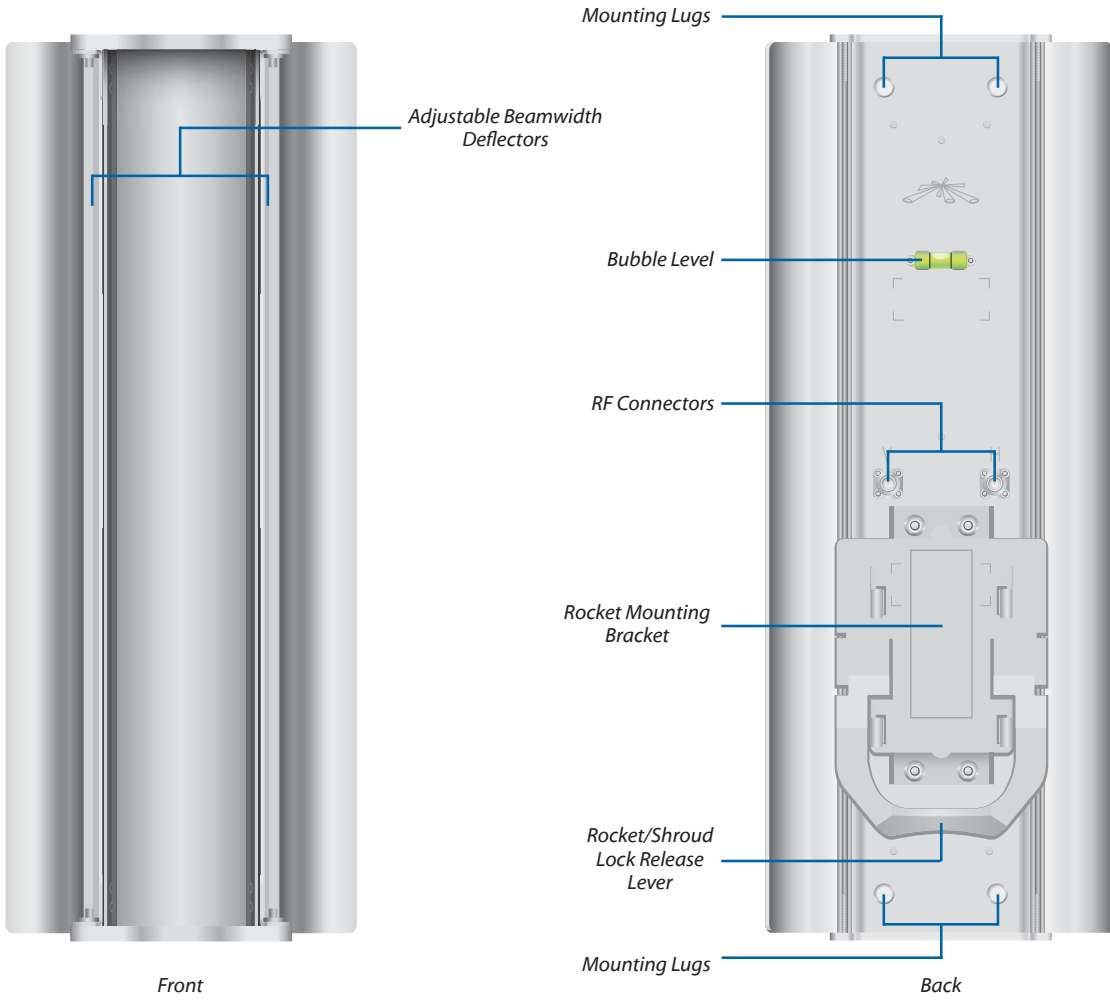

Specifications

Model: AM-V2G-Ti	
Dimensions	773 x 372 x 120 mm
Weight	6.40 kg (with Brackets)
Frequency Range	2.3 - 2.6 GHz
Beamwidth Angles	60°/ 90°/ 120°
Gain (Beamwidth Dependent)	17 dBi @ 60° 16 dBi @ 90° 15 dBi @ 120°
Elevation Beamwidth	4°
Electrical Downtilt	4°
Wind Survivability	125 mph
Wind Loading	92 lbs @ 100 mph
Polarization	Dual Linear
Cross-Pol Isolation	25 dB Typical
Front-to-Back Ratio	30 dB Typical
Max. VSWR	1.5:1
RF Connectors	2 RP-SMA Connectors (Weatherproof)
Compatible Radios	RocketM2 Titanium RocketM2
Mounting	Pole Mount (Kit Included)
ETSI Specification	EN 302 326 DN2
Certifications	CE, FCC, IC

Model: AM-V5G-Ti	
Dimensions	721 x 149.1 x 75.7 mm
Weight	3.72 kg (with Brackets)
Frequency Range	5.45 - 5.85 GHz
Beamwidth Angles	60°/ 90°/ 120°
Gain (Beamwidth Dependent)	21 dBi @ 60° 20 dBi @ 90° 19 dBi @ 120°
Elevation Beamwidth	4°
Electrical Downtilt	2°
Wind Survivability	125 mph
Wind Loading	37 lbs @ 120 mph
Polarization	Dual Linear
Cross-Pol Isolation	25 dB Typical
Front-to-Back Ratio	30 dB Typical
Max. VSWR	1.5:1
RF Connectors	2 RP-SMA Connectors (Weatherproof)
Compatible Radios	RocketM5 Titanium RocketM5 GPS RocketM5
Mounting	Pole Mount (Kit Included)
ETSI Specification	EN 302 326 DN2
Certifications	CE, FCC, IC

Specifications

Model: AM-M-V5G-Ti	
Dimensions	385 x 149 x 76 mm
Weight	3.25 kg (with Brackets)
Frequency Range	5.45 - 5.85 GHz
Beamwidth Angles	60°/ 90°/ 120°
Gain (Beamwidth Dependent)	17 dBi @ 60° 16 dBi @ 90° 15 dBi @ 120°
Elevation Beamwidth	4°
Electrical Downtilt	3°
Wind Survivability	125 mph
Wind Loading	15 lbf @ 100 mph
Polarization	Dual Linear
Cross-Pol Isolation	25 dB Typical
F/B Ratio	35 dB Typical
Max. VSWR	1.7:1
RF Connectors	2 RP-SMA Connectors (Weatherproof)
Compatible Radios	RocketM5 Titanium RocketM5 RocketM5 GPS
Mounting	Pole Mount (Kit Included)
ETSI Specification	EN 302 326 DN2
Certifications	CE, FCC, IC

Vertical Azimuth

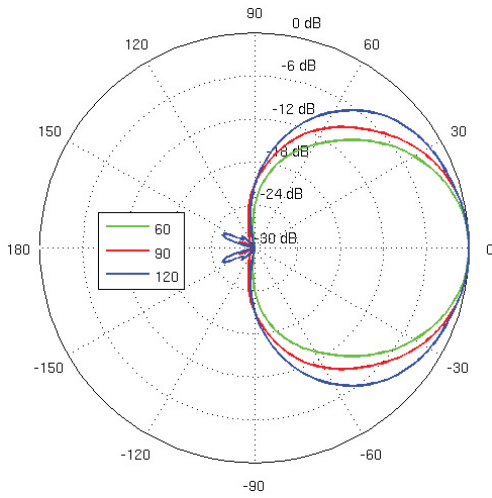

Vertical Elevation

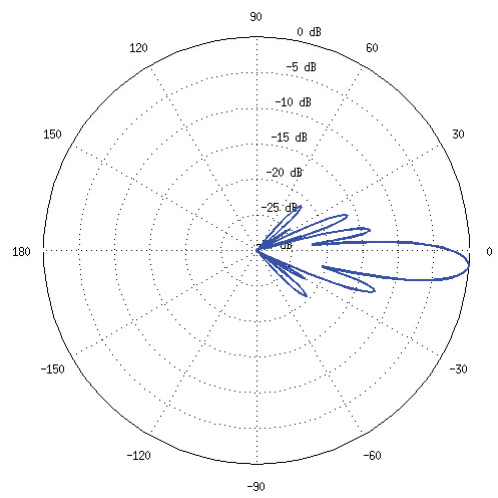

Horizontal Azimuth

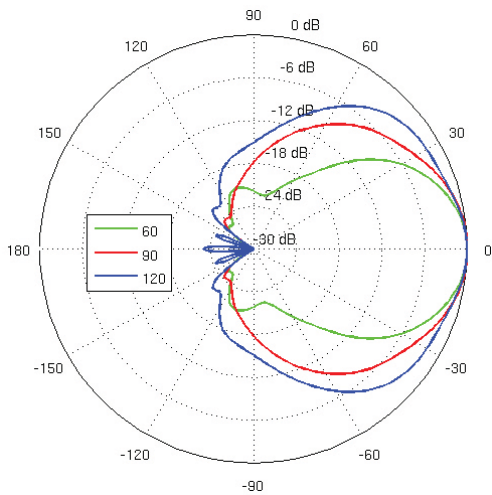

Horizontal Elevation

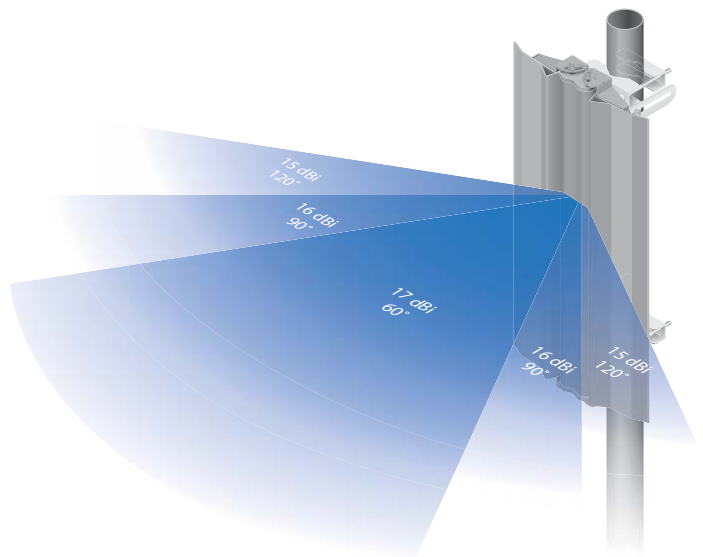
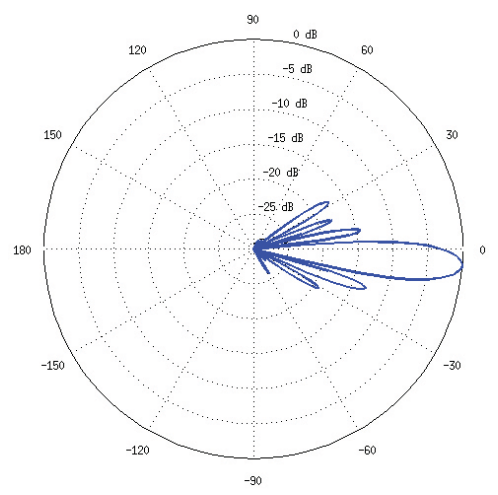

Vertical Azimuth

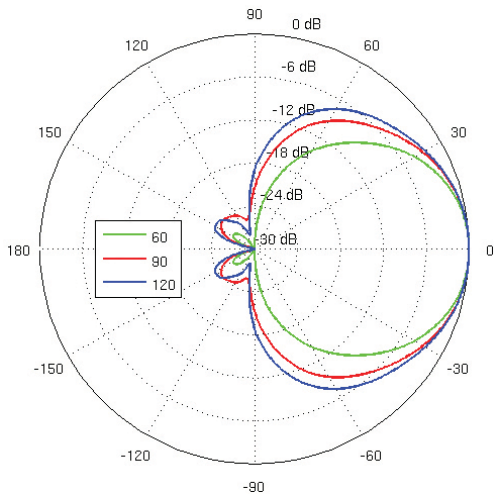

Vertical Elevation

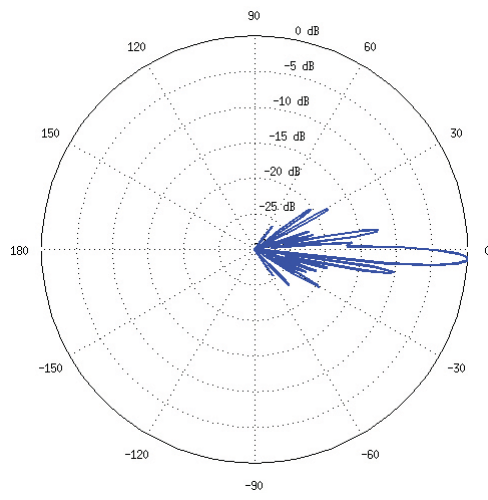

Horizontal Azimuth

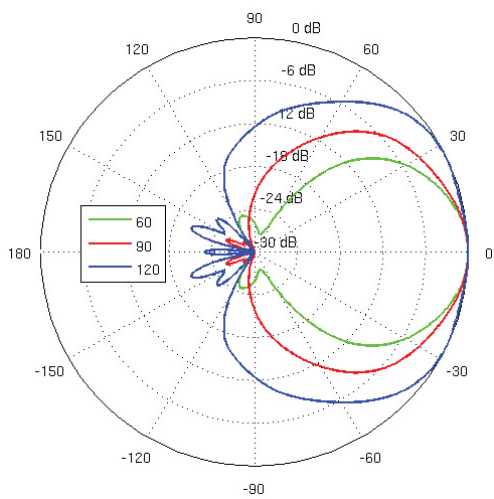

Horizontal Elevation

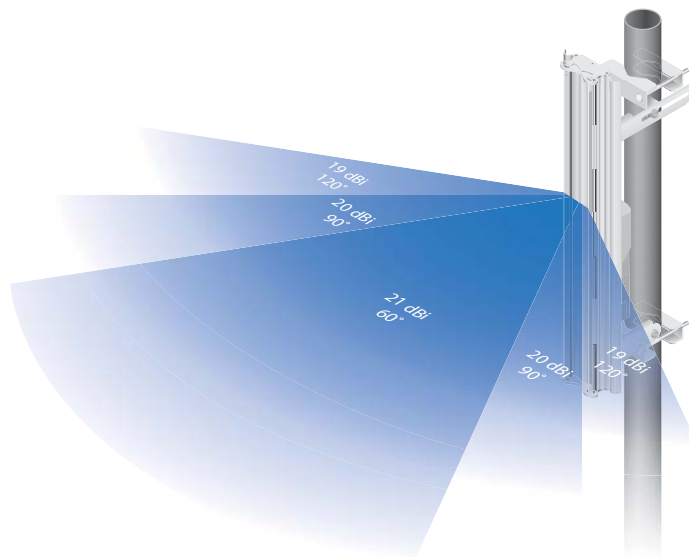
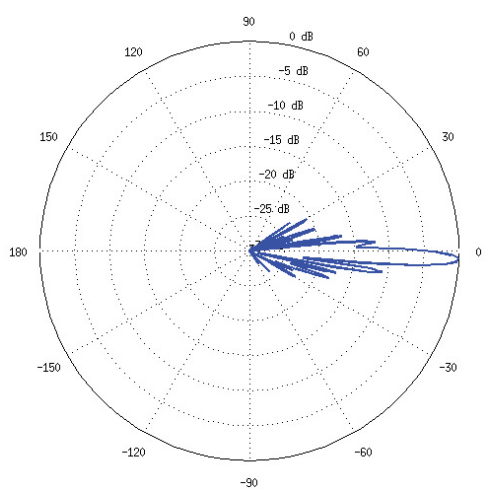

Vertical Azimuth

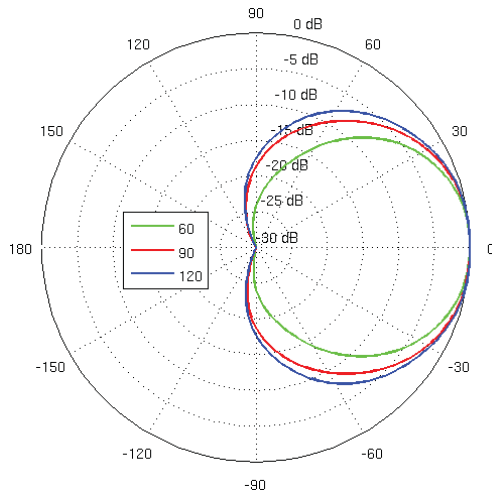

Vertical Elevation

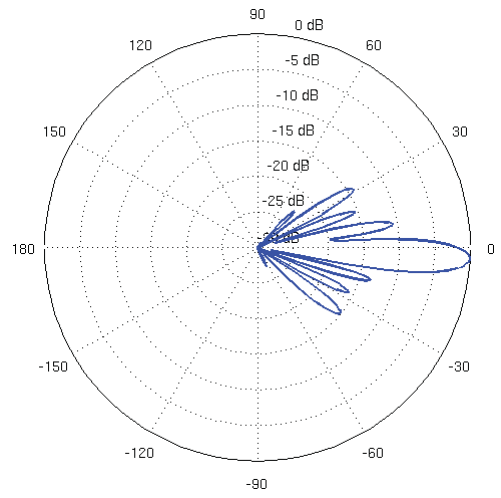

Horizontal Azimuth

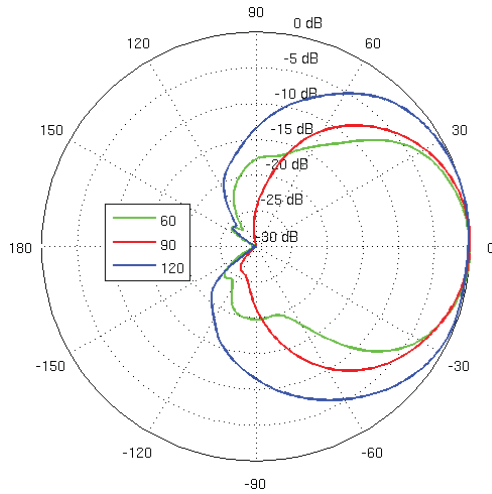

Horizontal Elevation

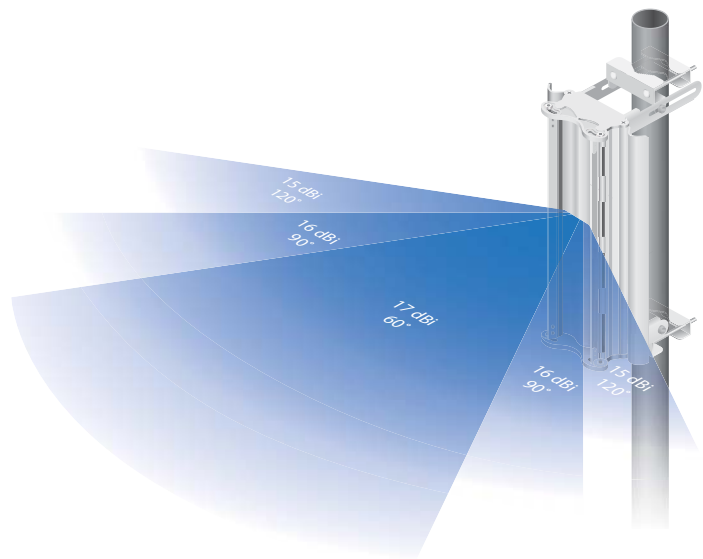
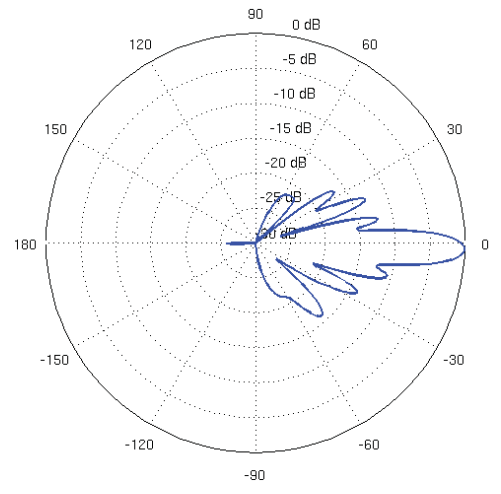

TOUGH Cable™

OUTDOOR CARRIER CLASS SHIELDED

Protect your networks from the most brutal environments with Ubiquiti Networks' industrial-grade, shielded Ethernet cable, TOUGH Cable.

Increase Performance

Dramatically improve your Ethernet link states, speeds, and overall performance with Ubiquiti TOUGH Cables.

Extreme Weatherproof

Designed for outdoor use, TOUGH Cables have been built to perform even in the harshest weather and environments.

ESD Damage Protection

Protect your networks from devastating electrostatic discharge (ESD) attacks.

Extended Cable Support

TOUGH Cables have been developed to increase power handling performance for extended cable run lengths.

Bulletproof your networks

TOUGH Cable is currently available in two versions: PRO Shielding Protection and CARRIER Shielding Protection.

TOUGH Cable PRO is a Category 5e, outdoor, carrier-class shielded cable with an integrated ESD drain wire.

TOUGH Cable CARRIER is a Category 5e, outdoor, carrier-class shielded cable that features an integrated ESD drain wire, anti-crosstalk divider, and secondary shielding. It is rated to provide optimal performance on Gigabit Ethernet networks.

Additional Information:

- 24 AWG copper conductor pairs
- 26 AWG integrated ESD drain wire to prevent ESD attacks and damage
- PE outdoor-rated, weatherproof jacket
- Multi-layered shielding
- Available in lengths of 1000 ft (304.8 m)

TERMS OF USE: Ubiquiti radio devices must be professionally installed. Shielded Ethernet cable and earth grounding must be used as conditions of product warranty. TOUGH Cable is designed for outdoor installations. It is the installer's responsibility to follow local country regulations, including operation within legal frequency channels, output power, indoor cabling requirements, and Dynamic Frequency Selection (DFS) requirements.

For further information, please visit www.ubnt.com.

All specifications in this document are subject to change without notice.

© 2012 Ubiquiti Networks, Inc. All rights reserved.



TOUGH Cable Connectors

Specifically designed for use with Ubiquiti TOUGH Cables and available in 100-pc. bags, TOUGH Cable Connectors protect against ESD attacks and Ethernet hardware damage, while allowing rapid field deployment without soldering.

ESD attacks are the leading cause for device failures. The diagram below illustrates the areas vulnerable to ESD attacks in a network.

By using a grounded Ubiquiti Power over Ethernet (PoE) Adapter along with Ubiquiti TOUGH Cable and TOUGH Cable Connectors, you can effectively protect against ESD attacks.

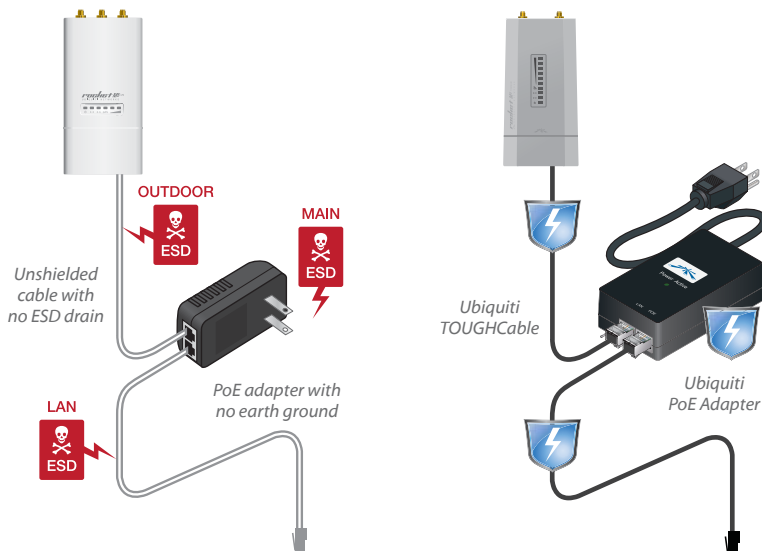

www.ubnt.com

PHJL122112