

# PIC32-PINGUINO and PIC32-PINGUINO-OTG development boards user's manual

All boards produced by Olimex are ROHS compliant

Revision E, October 2013

Designed by OLIMEX Ltd, 2011

## INTRODUCTION:

### What is Arduino?

Arduino is an open-source electronics prototyping platform, designed to make the process of using electronics in multidisciplinary projects more accessible. The hardware consists of a simple open hardware design for the Arduino board with an Atmel AVR processor and on-board I/O support. The software consists of a standard programming language and the boot loader that runs on the board.

Arduino hardware is programmed using a Wiring-based language (syntax + libraries), similar to C++ with some simplifications and modifications, and a Processing-based IDE.

The project began in Ivrea, Italy in 2005 to make a device for controlling student-built interaction design projects less expensively than other prototyping systems available at the time. As of February 2010 more than 120,000 Arduino boards had been shipped. Founders Massimo Banzi and David Cuartielles named the project after a local bar named Arduino. The name is an Italian masculine first name, meaning "strong friend". The English pronunciation is "Hardwin", a namesake of Arduino of Ivrea.

More information could be found at the creators web page <http://arduino.cc/> and in the Arduino Wiki <http://en.wikipedia.org/wiki/Arduino>

To make the story short - Arduino is easy for the beginners with lack of Electronics knowledge, but also do not restrict the professionals as they can program it in C++ or mix of Arduino/C++ language.

There are thousands of projects which makes the startup easy as there is barely no field where Arduino enthusiasts to have not been already.

Arduino has inspired two other major derivatives - MAPLE and PINGUINO. Based on 8-bit AVR technology the computational power of Arduino boards are modest, this is why team from MIT developed **MAPLE** project which is based on ARM7 STM32F103RBT6 microcontroller, the board have same friendly IDE as Arduino and offers the same capabilities as hardware and software but runs the Arduino code much faster. Maple project can be found at <http://leaflabs.com>

In parallel with Arduino another project was started called **PINGUINO**. This project choose the first implementation to be with PIC microcontrollers, the reason was that AVRs were hard to find in some parts of the world like South America so you will see lot of **PINGUINO** developers are from there. **PINGUINO** project founders decided to go with Python instead Java for processing language. For the moment **PINGUINO** is much more flexible than Arduino as not limited to 8bit, currently the IDE which have GCC in background can support 8-bit PIC microcontrollers, 32bit PIC32 (MIPS) microcontrollers and ARM7/CORTEXM3 microcontrollers which makes **PINGUINO** very flexible as once you make your project you can migrate easily through different hardware platforms and not being connected to single microcontroller manufacturer. The PINGUINO project can be found at <http://www.pinguino.cc>

## **BOARD FEATURES:**

We entered the Arduino/MAPLE field 5 years after the introductions of the design, and this allowed us to see and skip most of the errors the Arduino inventors did :-)

We had the possibility to read current customer feedback and to implement what they wanted to see in the original Arduino.

1. The original Arduino/Maple uses linear power supply, this limits the input voltage range. We designed the power supply to accept power in the 9 to 30V DC range thus making it possible to take virtually any power supply adapter on the market; this also enables application which are in industrial power supply 24VDC.
2. We carefully selected all components to work reliable in **the INDUSTRIAL temperature range -25+85C** so the board can be used in INDUSTRIAL applications while the original design is up to the commercial 0-70C operating temperature.
3. The original Arduino/MAPLE design is not good for portable applications as consumes too much power with the linear voltage regulators, we put ULTRA LOW POWER voltage regulators and the consumption is only few microamps, which enables hand-held and battery powered applications.
4. We added Li-Ion rechargeable battery power supply option with BUILD-IN on board charger, so when you attach battery it is automatically charged and kept in this state until the other power source (USB or external adapter) is removed and it will AUTOMATICALLY power the board - no jumpers, no switches!
5. Our board has UEXT connector which allows many existing modules like RF, ZIGBEE, GSM, GPS to be connected.
6. Our board has SD-MMC card for data logging.
7. Our board has USB-OTG hardware.
8. Our design allows RTC - Real Time Clock.
9. We made our design noise immune.
10. Optionally if someone needs higher precision and temperature stability in Analog reading we have provisioned the board with Aref precise source.
11. The LEDs and the BUTTONs are on the edge of the board so that there is easy access even if the boards have shields mounted.
12. All components are LOWER than the connectors, so the shields do not interfere with them.
13. Mini USB connector is used which is common and used in most cell phones, so you do not have to buy other cables.
14. Original Arduino design had flaw and the connectors were not spaced at 0.1" thus making the usage of proto boards impossible, to keep the compatibility we have same spacing but we also added next to it a connector with 0.1" step which customers can use with perforated boards.

15. All signals on the connectors are printed on the top and on the bottom of the board, so when you check with probe you know exactly which port you are measuring.
16. 4 mount holes to make board attachment easier.

## **ELECTROSTATIC WARNING:**

The **PIC32-PINGUINO** and **PIC32-PINGUINO-OTG** boards are shipped in protective anti-static packaging. The boards must not be subject to high electrostatic potentials. General practice for working with static sensitive devices should be applied when working with these boards.

## **BOARD USE REQUIREMENTS:**

- Cables:** Mini USB cable
- For programming via ICSP connector you will need PIC-ICSP connector and USB A-B cable for, PIC-KIT3.
- Hardware:** Programmer/Debugger – PIC-KIT3, or other compatible programming/debugging tool.
- !!!Warning!!!** PIC-ICD2, PIC-ICD2-POCKET and PIC-ICD2-TINY are not supported nor recommended. They lack software support in newer MPLABs

## **MAIN DIFFERENCES BETWEEN THE TWO BOARDS:**

The main difference between PIC32-PINGUINO and PIC32-PINGUINO-OTG is the USB connector. The first board has a standard USB connector that is configured as a device which allows the board to communicate only with hosts. The PIC32-PINGUINO-OTG can be configured either as a device or a host – which allows the board to communicate with devices also – e.g. USB smartphones, keyboards, mice etc.

# SCHEMATICS:

## PIC32-PINGUINO

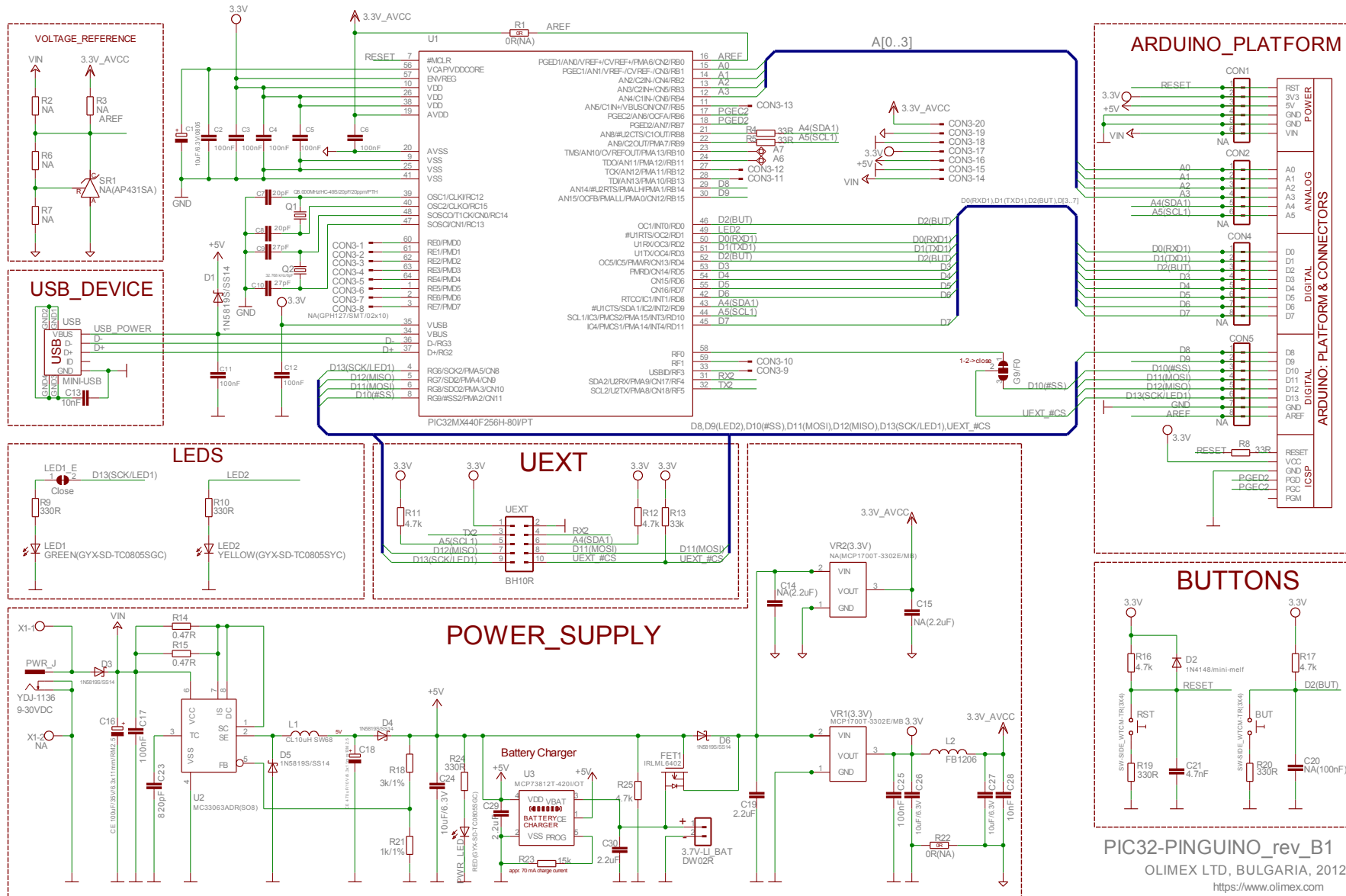

# PIC32-PINGUINO-OTG

Designed by Olimex\_LTD

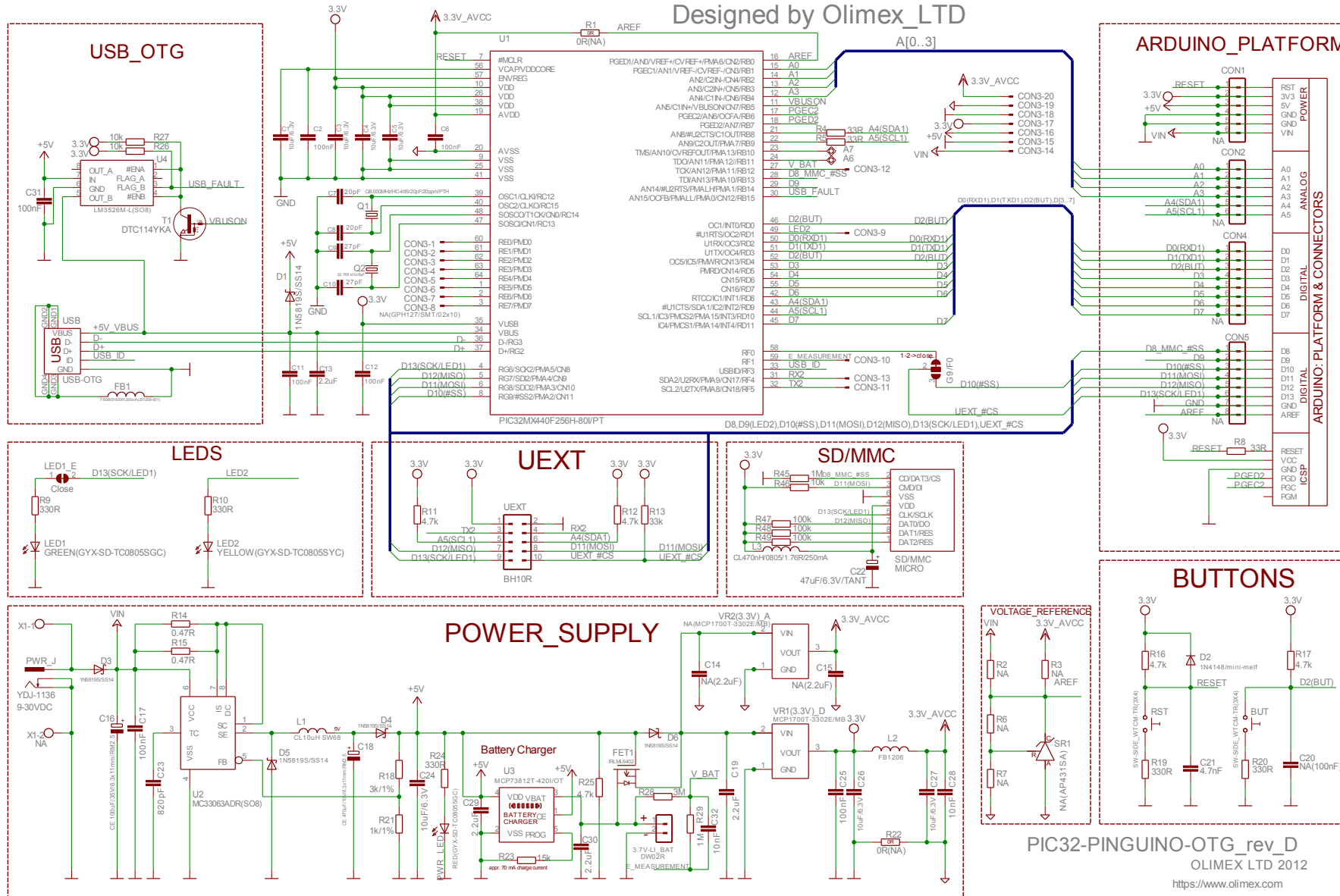

# BOARD LAYOUT:

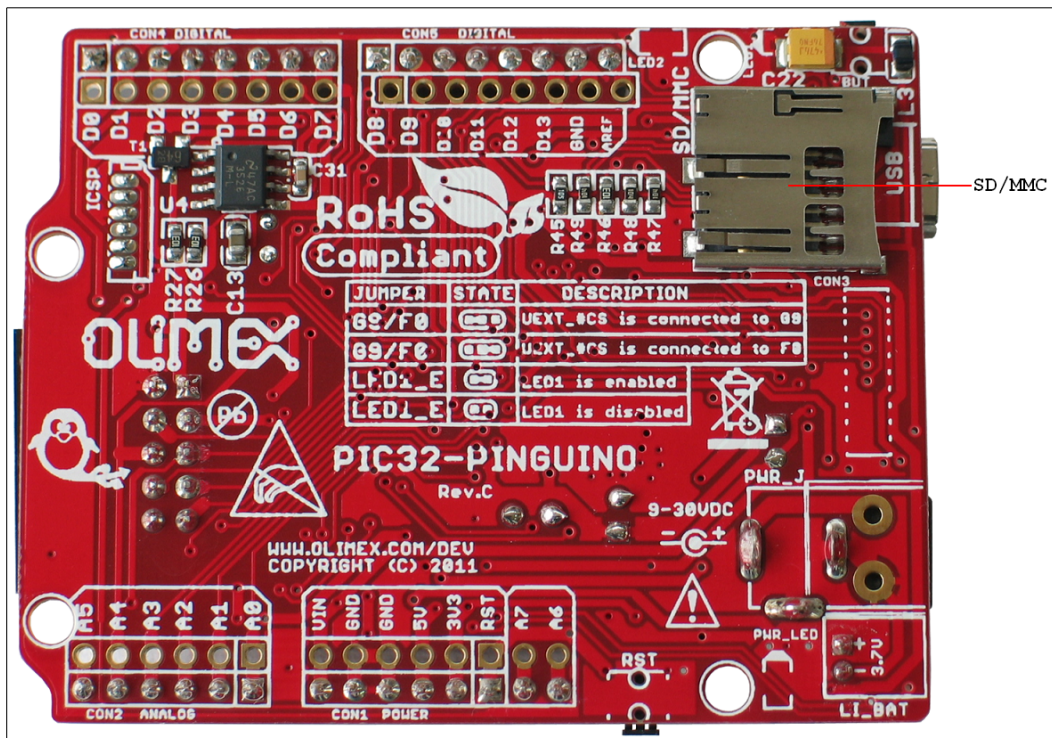
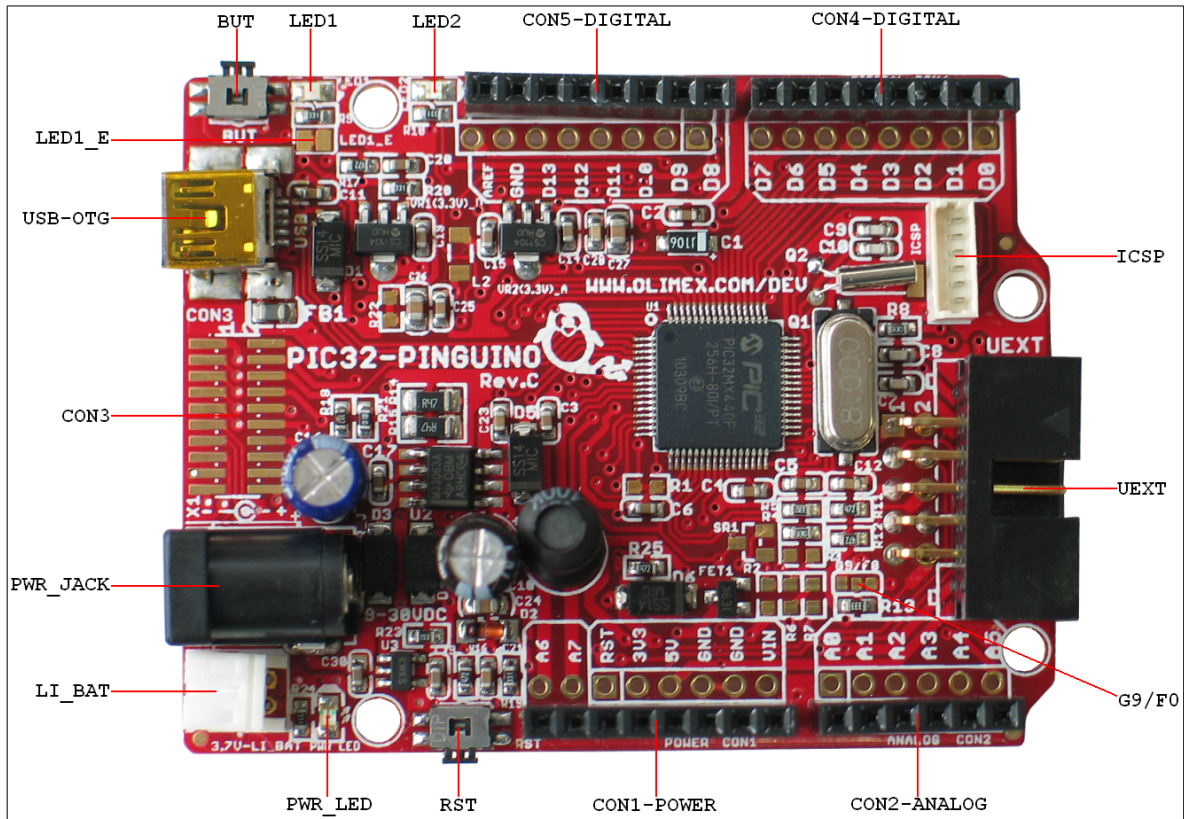

## **POWER SUPPLY CIRCUIT:**

**PIC32-PINGUINO/-OTG** can take power supply from:

- external power supply (9-30) VDC.
- + 5V from USB
- 3.7 V Li-ion battery

The programmed board power consumption is about 100 mA with all peripherals enabled.

## **RESET CIRCUIT:**

**PIC32-PINGUINO/-OTG** reset circuit includes D2 (1N4148), R16 (4.7k $\Omega$ ), R19 (330 $\Omega$ ), C21 (4.7nF), PIC32MX440F256H pin 7 (#MCLR) and RESET button.

## **CLOCK CIRCUIT:**

Quartz crystal **Q1** 8 MHz is connected to PIC32MX440F256H pin 39 (OSC1/CLKI/RC12) and pin 40 (OSC2/CLKO/RC15).

Quartz crystal **Q2** 32.768 kHz is connected to PIC32MX440F256H pin 47 (SOSCI/CN1/RC13) and pin 48 (SOSCO/T1CK/CN0/RC14).



## JUMPER DESCRIPTION:

### LED1\_E



This jumper, when closed, enables LED1.  
Default state is closed.

### G9/F0



This jumper, when is in position G9 – connects UEXT pin 10 (UEXT\_#CS) to CON5 pin 3 (D10(#SS)) and when is on position F0 – connects UEXT pin 10 (UEXT\_#CS) to PIC32MX440F256H pin 58 (RF0).

Default state is in position F0.

## INPUT/OUTPUT:

**Status Led** with name **LED1 (green)** connected via jumper LED1\_E to PIC32MX440F256H pin 4 (RG6) – signal D13(SCK/LED1).

**Status Led** with name **LED2 (yellow)** connected to PIC32MX440F256H pin 49 (#U1RTS/OC2/RD1).

**Power-on LED (red)** with name **PWR\_LED** – this LED shows that the board is power supplied.

**User button** with name **BUT** connected to **PIC32MX440F256H** pin 46 (OC1/INT0/RD0) and pin 52 (OC5/IC5/PMWR/CN13/RD4) – signal D2(BUT).

**Note that you should be careful with D2 signal on the digital connector since it goes to two microcontroller pins.**

**User button** with name **RST** connected to **PIC32MX440F256H** pin 7 (#MCLR).

**EXTERNAL CONNECTORS DESCRIPTION:**

**ICSP:**

Pin #	Signal Name
1	RESET
2	+3.3V
3	GND
4	PGED2
5	PGEC2
6	Not connected

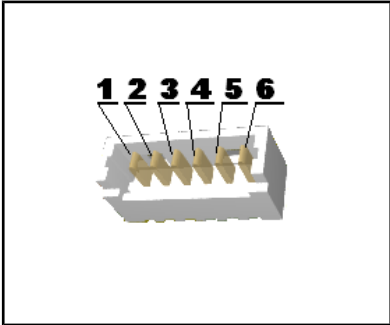

**UEXT:**

Pin #	Signal Name
1	+3.3V
2	GND
3	TX2
4	RX2
5	A5(SCL1)
6	A4(SDA1)
7	D12(MISO)
8	D11(MOSI)
9	D13(SCK/LED1)
10	UEXT_#CS

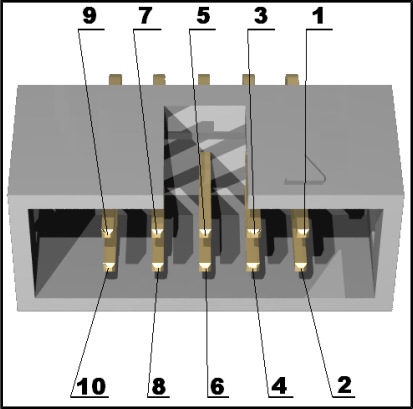

### CON1 – POWER:

Pin #	Signal Name
1	RESET
2	+3.3V
3	+5V
4	GND
5	GND
6	VIN

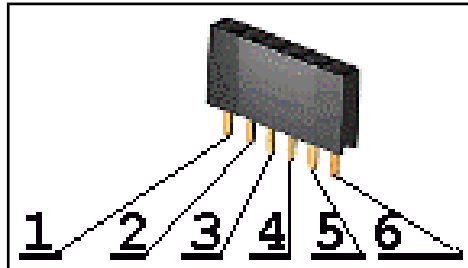

### CON2 – ANALOG:

Pin #	Signal Name
1	A0
2	A1
3	A2
4	A3
5	A4(SDA1)
6	A5(SCL1)

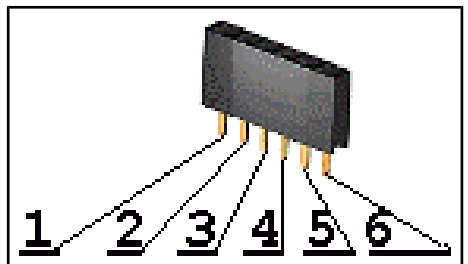

### PWR JACK:

Pin #	Signal Name
1	Power Input
2	GND

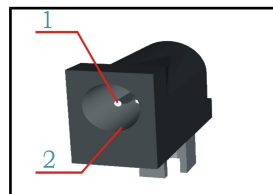

### CON4 – DIGITAL:

Pin #	Signal Name
1	D0(RXD1)
2	D1(TXD1)
3	D2(BUT)
4	D3
5	D4
6	D5
7	D6
8	D7

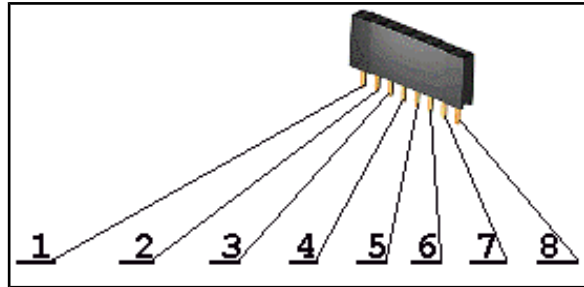

### CON5 – DIGITAL:

Pin #	Signal Name
1	D8_MMC_#SS
2	D9
3	D10(#SS)
4	D11(MOSI)
5	D12(MISO)
6	D13(SCK/LED1)
7	GND
8	AREF

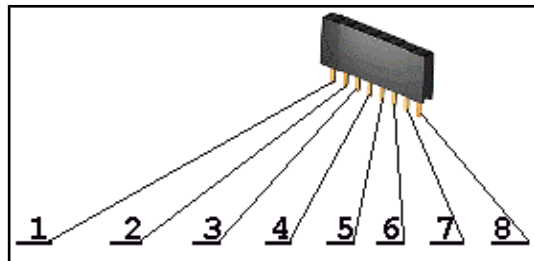

### LI BAT:

Pin #	Signal Name
1	VBAT
2	GND

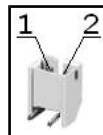

## USB-OTG (On-The-Go):

Note that it is present only in the PIC32-PINGUINO-OTG version

Pin #	Signal Name
1	+5V_VBUS
2	D -
3	D +
4	USB_ID
5	GND

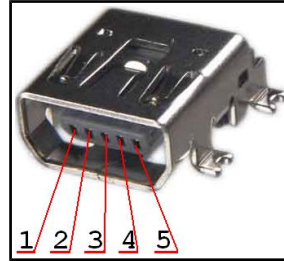

## SD/MMC:

Pin #	Signal Name
1	MCIDAT2
2	D8_MMC_#SS
3	D11(MOSI)
4	+3.3V
5	D13(SCK/LED1)
6	GND
7	D12(MISO)
8	MCIDAT1
9	Not connected
10	Not connected
11	Not connected
12	Not connected

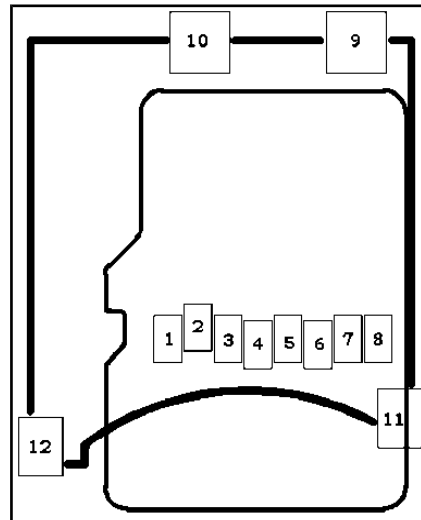

### CON3:

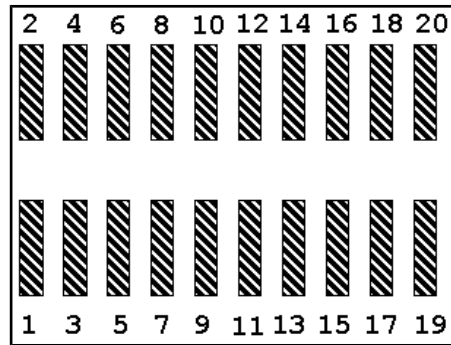

Pin #	Signal Name	Pin #	Signal Name
1	RE0	2	RE1
3	RE2	4	RE3
5	RE4	6	RE5
7	RE6	8	RE7
9	LED2	10	RF1
11	TX2	12	RB12
13	RX2	14	VIN
15	GND	16	+5V
17	+3.3V	18	GND
19	AGND	20	VDD

Note: This connector is not mounted on the board.

# MECHANICAL DIMENSIONS:

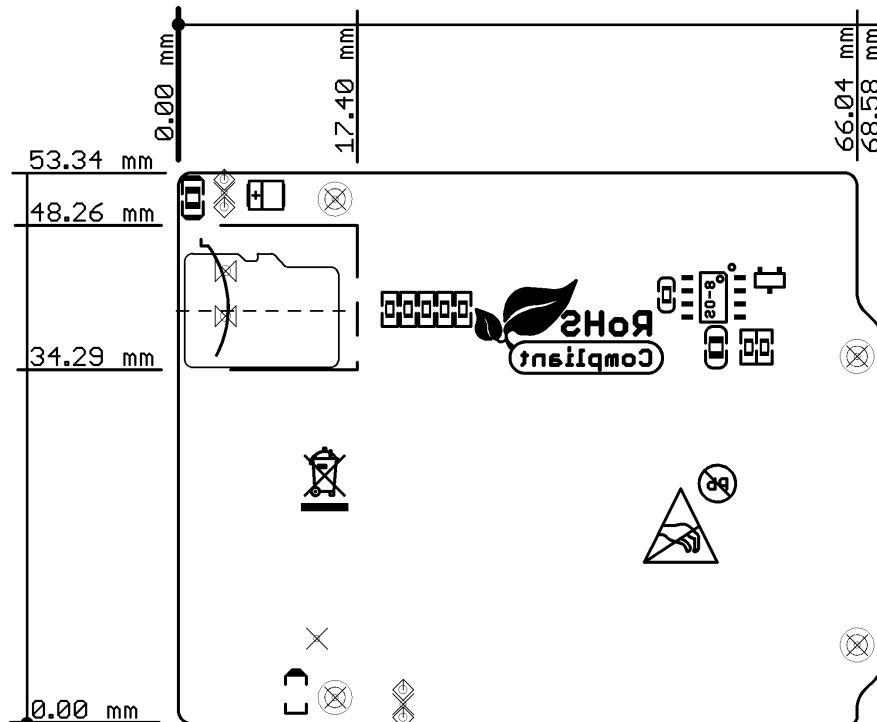
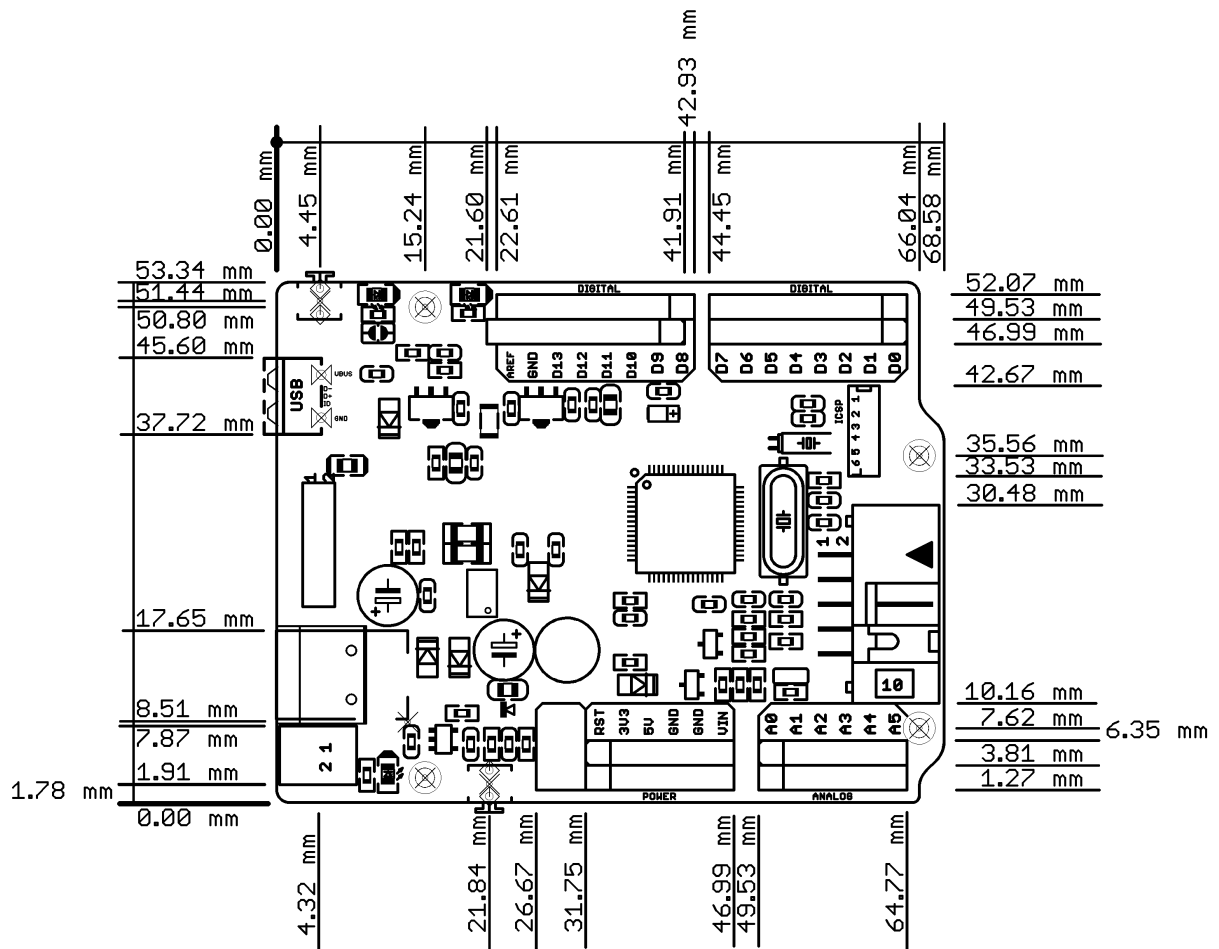

## **AVAILABLE DEMO SOFTWARE:**

There are numerous projects available in the software section of PIC32-PINGUINO and PIC32-PINGUINO-OTG web pages:

<https://www.olimex.com/Products/Duino/PIC32/PIC32-PINGUINO/>

<https://www.olimex.com/Products/Duino/PIC32/PIC32-PINGUINO-OTG/>



## **ORDER CODE:**

**PIC32-PINGUINO** – fully assembled and tested board

**PIC32-PINGUINO-OTG** – fully assembled and tested board

### **How to order?**

You can order to us directly or by any of our distributors.  
Check our web <https://www.olimex.com/> for more info.

## **Revision history:**

### **Board's revision**

Rev. C, March 2011

Rev. D, March 2012

- Changed various names on the top and the bottom of the board
- Removed C14 - 2.2uF, C15 - 2.2uF, VR2-MCP1700T-3302E/MB; Added L2-FB1206 – because of random hangs of the PIC32 in specific cases
- Removed C20 – was filtering not only the button bounce but some of the higher frequencies which we decided to change

### **Manual's revision**

Rev. A, August 2011

- At first page "Copyright(c) 2011, OLIMEX Ltd, All rights reserved" is replaces with "Designed by OLIMEX Ltd., 2011"
- In schematic "COPYRIGHT(C) 2011, OLIMEX Ltd." replaced with "DESIGNED BY OLIMEX LTD, 2011"

Rev. B, October 2011

- In "BOARD USE REQUIREMENTS" added more information about cables; "Hardware" and "Warning"
- The picture for USB on-the-go connector is changed

Rev. C, March 2012

- Removed "*10 .We use separate voltage regulator for the Analog part, which allow the ADC to be read correctly without the digital noise pickup.*"
- Updated schematic with board version D
- Various spelling changes and page formatting

Rev. D, October 2012

- Adjusted the manual for both PIC32-PINGUINO and PIC32-PINGUINO-OTG
- Updated disclaimer
- Updated schematic with board version D

- Various spelling changes and page formatting

Rev E October 2013

- Added additional note about the D2 signal to make it more obvious.
- Updated disclaimer

© 2013 Olimex Ltd. Olimex®, logo and combinations thereof, are registered trademarks of Olimex Ltd. Other product names may be trademarks of others and the rights belong to their respective owners.

**The information in this document is provided in connection with Olimex products. No license, express or implied or otherwise, to any intellectual property right is granted by this document or in connection with the sale of Olimex products.**

The Hardware project is released under the Creative Commons Attribution-Share Alike 3.0 United States License. You may reproduce it for both your own personal use, and for commercial use. You will have to provide a link to the original creator of the project <http://www.olimex.com> on any documentation or website.

You may also modify the files, but you must then release them as well under the same terms. Credit can be attributed through a link to the creator website: <http://www.olimex.com>

The software is released under GPL.

It is possible that the pictures in this manual differ from the latest revision of the board.

The product described in this document is subject to continuous development and improvements. All particulars of the product and its use contained in this document are given by OLIMEX in good faith. However all warranties implied or expressed including but not limited to implied warranties of merchantability or fitness for purpose are excluded. This document is intended only to assist the reader in the use of the product. OLIMEX Ltd. shall not be liable for any loss or damage arising from the use of any information in this document or any error or omission in such information or any incorrect use of the product.

This evaluation board/kit is intended for use for engineering development, demonstration, or evaluation purposes only and is not considered by OLIMEX to be a finished end-product fit for general consumer use. Persons handling the product must have electronics training and observe good engineering practice standards. As such, the goods being provided are not intended to be complete in terms of required design-, marketing-, and/or manufacturing-related protective considerations, including product safety and environmental measures typically found in end products that incorporate such semiconductor components or circuit boards.

Olimex currently deals with a variety of customers for products, and therefore our arrangement with the user is not exclusive. Olimex assumes no liability for applications assistance, customer product design, software performance, or infringement of patents or services described herein.

**THERE IS NO WARRANTY FOR THE DESIGN MATERIALS AND THE COMPONENTS USED TO CREATE PIC32-PIGNOINO. THEY ARE CONSIDERED SUITABLE ONLY FOR PIC32-PINGUINO.**