

ASUS®

**PB287 Series
LCD Monitor**

User Guide

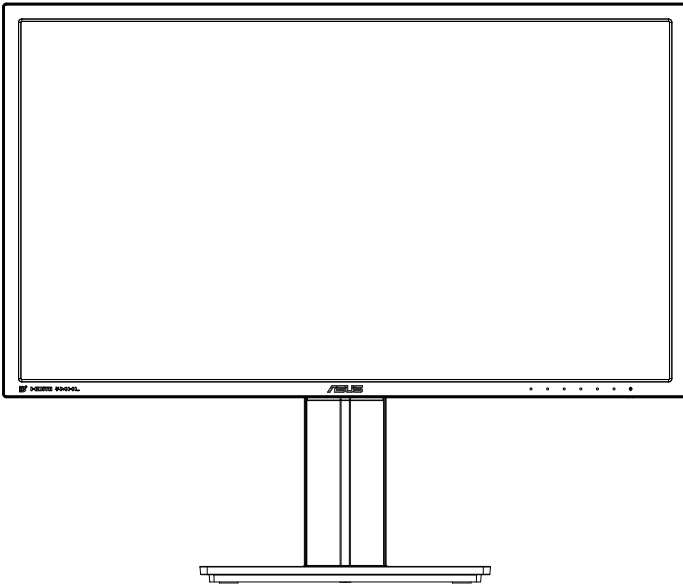

Table of contents

- Notices iii
- Safety information iv
- Care & Cleaning v
- 1.1 Welcome! 1-1
- 1.2 Package contents..... 1-1
- 1.3 Assembling the monitor base..... 1-2
- 1.4 Connect cables..... 1-2
 - 1.4.1 Detaching the cable cover 1-2
 - 1.4.2 Rear of the LCD monitor 1-3
- 1.5 Monitor introduction 1-4
 - 1.5.1 Using the Controls button 1-4
 - 1.5.2 QuickFit Function 1-6
- 2.1 Detaching the arm/stand (for VESA wall mount) 2-1
- 2.2 Adjusting the monitor..... 2-2
- 3.1 OSD (On-Screen Display) menu 3-1
 - 3.1.1 How to reconfigure..... 3-1
 - 3.1.2 OSD Function Introduction..... 3-2
- 3.2 Specifications..... 3-12
- 3.3 Troubleshooting (FAQ)..... 3-13
- 3.4 Supported Timing List..... 3-14

Copyright © 2014 ASUSTeK COMPUTER INC. All Rights Reserved.

No part of this manual, including the products and software described in it, may be reproduced, transmitted, transcribed, stored in a retrieval system, or translated into any language in any form or by any means, except documentation kept by the purchaser for backup purposes, without the express written permission of ASUSTeK COMPUTER INC. ("ASUS").

Product warranty or service will not be extended if: (1) the product is repaired, modified or altered, unless such repair, modification of alteration is authorized in writing by ASUS; or (2) the serial number of the product is defaced or missing.

ASUS PROVIDES THIS MANUAL "AS IS" WITHOUT WARRANTY OF ANY KIND, EITHER EXPRESS OR IMPLIED, INCLUDING BUT NOT LIMITED TO THE IMPLIED WARRANTIES OR CONDITIONS OF MERCHANTABILITY OR FITNESS FOR A PARTICULAR PURPOSE. IN NO EVENT SHALL ASUS, ITS DIRECTORS, OFFICERS, EMPLOYEES OR AGENTS BE LIABLE FOR ANY INDIRECT, SPECIAL, INCIDENTAL, OR CONSEQUENTIAL DAMAGES (INCLUDING DAMAGES FOR LOSS OF PROFITS, LOSS OF BUSINESS, LOSS OF USE OR DATA, INTERRUPTION OF BUSINESS AND THE LIKE), EVEN IF ASUS HAS BEEN ADVISED OF THE POSSIBILITY OF SUCH DAMAGES ARISING FROM ANY DEFECT OR ERROR IN THIS MANUAL OR PRODUCT.

SPECIFICATIONS AND INFORMATION CONTAINED IN THIS MANUAL ARE FURNISHED FOR INFORMATIONAL USE ONLY, AND ARE SUBJECT TO CHANGE AT ANY TIME WITHOUT NOTICE, AND SHOULD NOT BE CONSTRUED AS A COMMITMENT BY ASUS. ASUS ASSUMES NO RESPONSIBILITY OR LIABILITY FOR ANY ERRORS OR INACCURACIES THAT MAY APPEAR IN THIS MANUAL, INCLUDING THE PRODUCTS AND SOFTWARE DESCRIBED IN IT.

Products and corporate names appearing in this manual may or may not be registered trademarks or copyrights of their respective companies, and are used only for identification or explanation and to the owners' benefit, without intent to infringe.

Notices

Federal Communications Commission Statement

This device complies with Part 15 of the FCC Rules. Operation is subject to the following two conditions:

- This device may not cause harmful interference, and
- This device must accept any interference received including interference that may cause undesired operation.

This equipment has been tested and found to comply with the limits for a Class B digital device, pursuant to Part 15 of the FCC Rules. These limits are designed to provide reasonable protection against harmful interference in a residential installation. This equipment generates, uses and can radiate radio frequency energy and, if not installed and used in accordance with manufacturer's instructions, may cause harmful interference to radio communications. However, there is no guarantee that interference will not occur in a particular installation. If this equipment does cause harmful interference to radio or television reception, which can be determined by turning the equipment off and on, the user is encouraged to try to correct the interference by one or more of the following measures:

- Reorient or relocate the receiving antenna.
- Increase the separation between the equipment and receiver.
- Connect the equipment to an outlet on a circuit different from that to which the receiver is connected.
- Consult the dealer or an experienced radio/TV technician for help.



As an Energy Star® Partner, our company has determined that this product meets the Energy Star® guidelines for energy efficiency.

Canadian Department of Communications Statement

This digital apparatus does not exceed the Class B limits for radio noise emissions from digital apparatus set out in the Radio Interference Regulations of the Canadian Department of Communications.

This class B digital apparatus complies with Canadian ICES-003.

Safety information

- Before setting up the monitor, carefully read all the documentation that came with the package.
- To prevent fire or shock hazard, never expose the monitor to rain or moisture.
- Never try to open the monitor cabinet. The dangerous high voltages inside the monitor may result in serious physical injury.
- If the power supply is broken, do not try to fix it by yourself. Contact a qualified service technician or your retailer.
- Before using the product, make sure all cables are correctly connected and the power cables are not damaged. If you detect any damage, contact your dealer immediately.
- Slots and openings on the back or top of the cabinet are provided for ventilation. Do not block these slots. Never place this product near or over a radiator or heat source unless proper ventilation is provided.
- The monitor should be operated only from the type of power source indicated on the label. If you are not sure of the type of power supply to your home, consult your dealer or local power company.
- Use the appropriate power plug which complies with your local power standard.
- Do not overload power strips and extension cords. Overloading can result in fire or electric shock.
- Avoid dust, humidity, and temperature extremes. Do not place the monitor in any area where it may become wet. Place the monitor on a stable surface.
- Unplug the unit during a lightning storm or if it will not be used for a long period of time. This will protect the monitor from damage due to power surges.
- Never push objects or spill liquid of any kind into the slots on the monitor cabinet.
- To ensure satisfactory operation, use the monitor only with UL listed computers which have appropriate configured receptacles marked between 100 ~ 240V AC.
- The socket-outlet shall be installed near the equipment and shall be easily accessible
- If you encounter technical problems with the monitor, contact a qualified service technician or your retailer.
- Provide an earthing connection before the mains plug is connected to the mains. And, when disconnecting the earthing connection, be sure to disconnect after pulling out the mains plug from the mains.

Care & Cleaning

- Before you lift or reposition your monitor, it is better to disconnect the cables and power cord. Follow the correct lifting techniques when positioning the monitor. When lifting or carrying the monitor, grasp the edges of the monitor. Do not lift the display by the stand or the cord.
- Cleaning. Turn your monitor off and unplug the power cord. Clean the monitor surface with a lint-free, non-abrasive cloth. Stubborn stains may be removed with a cloth dampened with mild cleaner.
- Avoid using a cleaner containing alcohol or acetone. Use a cleaner intended for use with the LCD. Never spray cleaner directly on the screen, as it may drip inside the monitor and cause an electric shock.

The following symptoms are normal with the monitor:

- The screen may flicker during the initial use due to the nature of the fluorescent light. Turn off the Power Switch and turn it on again to make sure that the flicker disappears.
- You may find slightly uneven brightness on the screen depending on the desktop pattern you use.
- When the same image is displayed for hours, an afterimage of the previous screen may remain after switching the image. The screen will recover slowly or you can turn off the Power Switch for hours.
- When the screen becomes black or flashes, or cannot work anymore, contact your dealer or service center to fix it. Do not repair the screen by yourself!

Conventions used in this guide



WARNING: Information to prevent injury to yourself when trying to complete a task.



CAUTION: Information to prevent damage to the components when trying to complete a task.



IMPORTANT: Information that you **MUST** follow to complete a task.



NOTE: Tips and additional information to aid in completing a task.

Where to find more information

Refer to the following sources for additional information and for product and software updates.

1. ASUS websites

The ASUS websites worldwide provide updated information on ASUS hardware and software products. Refer to **<http://www.asus.com>**

2. Optional documentation

Your product package may include optional documentation that may have been added by your dealer. These documents are not part of the standard package.

1.1 Welcome!

Thank you for purchasing the ASUS® LCD monitor!

The latest widescreen LCD monitor from ASUS provides a crisper, broader, and brighter display, plus a host of features that enhance your viewing experience.

With these features, you can enjoy the convenience and delightful visual experience that the monitor brings you!

1.2 Package contents

Check your package for the following items:

- ✓ LCD Monitor
- ✓ Monitor Base
- ✓ Quick Start Guide
- ✓ Warranty Card
- ✓ 1x Power Cord
- ✓ 1x Audio Cable
- ✓ 1x DisplayPort Cable (option)
- ✓ 1x HDMI Cable (option)
- ✓ 1x DVI to HDMI Cable (option)
- ✓ 1x MHL Cable (option)



-
- If any of the above items is damaged or missing, contact your retailer immediately.
-

1.3 Assembling the monitor base

1. Attach the base to the arm. Beware to align the latch to the notch on the base.
2. The end of the arm will slightly protrude from the base. No need to push it in.
3. Screw the base to the arm tightly.

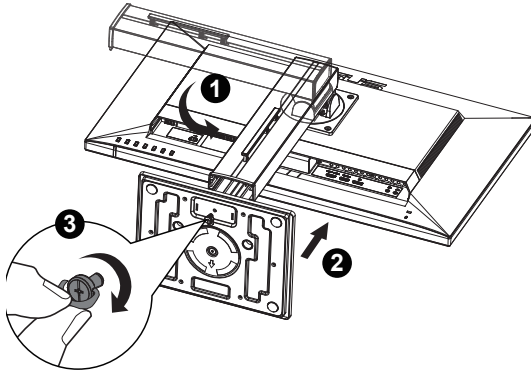

- We recommend that you cover the table surface with soft cloth to prevent damage to the monitor.

1.4 Connect cables

1.4.1 Detaching the cable cover

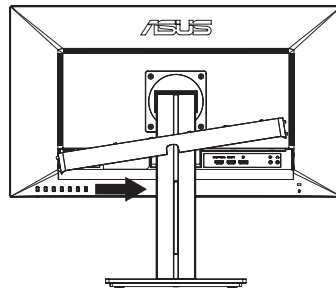
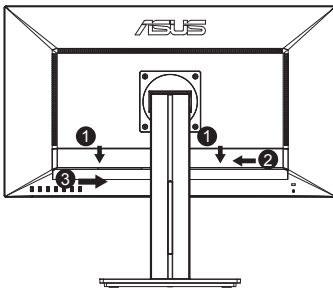

1.4.2 Rear of the LCD monitor

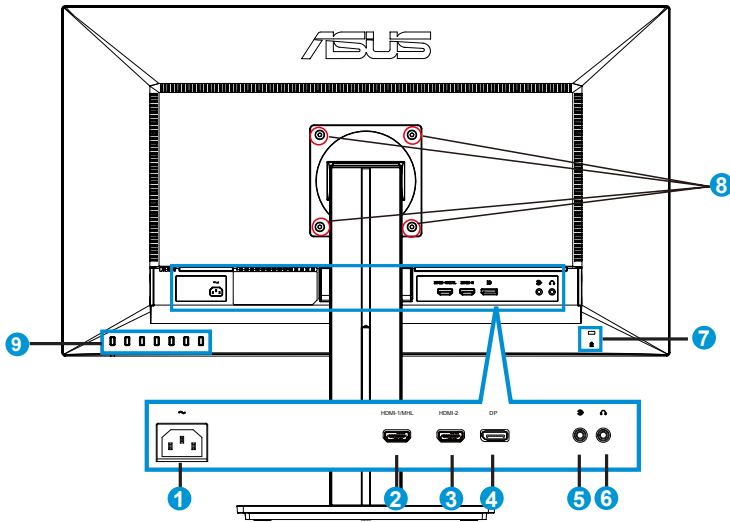

1. AC-IN port
2. HDMI-1 / MHL port
3. HDMI-2
4. DisplayPort
5. Audio - in Port
6. Earphone - out Port
7. Kensington Lock
8. Screw Holes for VESA Wall Mount
9. Control buttons



- Flip upward the IO port cover to connect cables. After connected cables, replace the cover and carefully push it upward to its original position with both thumbs at both sides of the cover.

1.5 Monitor introduction

1.5.1 Using the Controls button



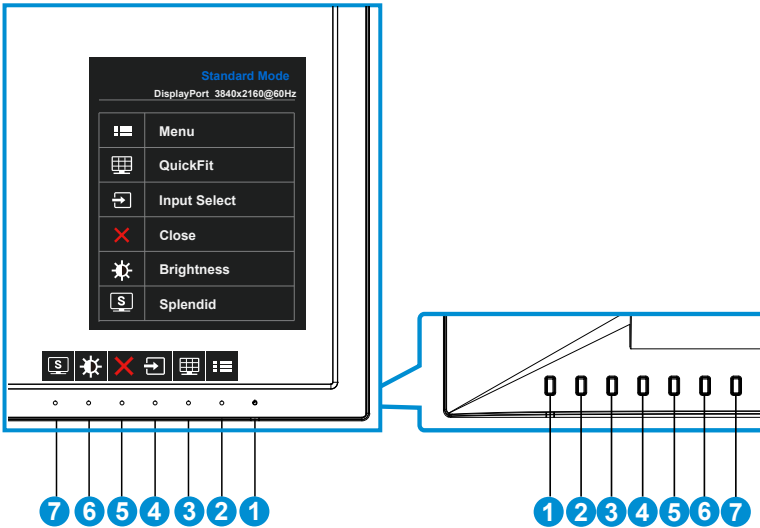

Use the control button on the back of the monitor to adjust the image settings.



1. Power Button/Power Indicator:
 - Press this button to turn the monitor on/off.
 - The color definition of the power indicator is as the below table.

Status	Description
White	ON
Amber	Standby mode
OFF	OFF

2. MENU Button:
 - Press this button to enter the OSD menu.
3. QuickFit Button:
 - This is a hotkey to activate the **QuickFit** function designed for alignment.
 - The **QuickFit** function contains 6 pages of common grid patterns, paper sizes, and photo sizes. See page 1-6 for details.

4.  Input Select Button:
 - Use this hotkey to switch from HDMI-1 / MHL, HDMI-2 or DisplayPort input signal.
5.  Close Button
 - Exit the OSD menu.
6.  Shortcut key1
 - This is a Shortcut key. The default setting is Brightness.
7.  Shortcut key2
 - This is a Shortcut key. The default setting is Splendid.

1.5.2 QuickFit Function

The QuickFit function contains three patterns: (1) Grid (2) Paper size (3) Photo size.

1. Grid pattern: Facilitates designers and users to organize content and layout on one page and achieve a consistent look and feel.

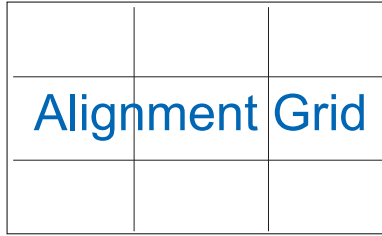

2. Paper size: Provides users to view their documents in real size on the screen.

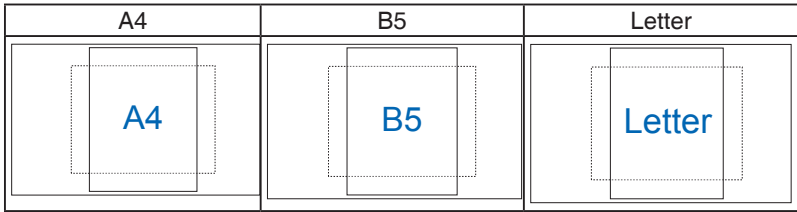

3. Photo size: Provides photographers and other users to accurately view and edit their photos in real size on the screen.

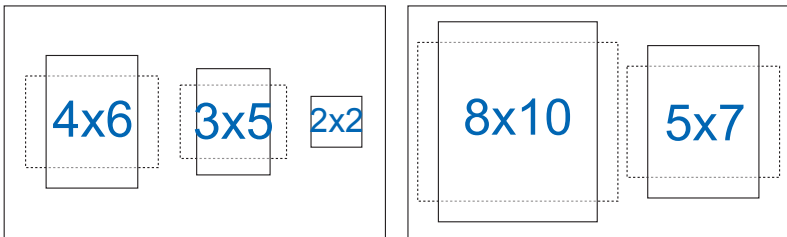

2.1 Detaching the arm/stand (for VESA wall mount)

The detachable stand of this monitor is specially designed for VESA wall mount.

1. Disconnect power and signal cables. Carefully put the front of the monitor face down on a clean table.
2. Use your fingers to loosen the screw located at the bottom of the base, and remove the base from the stand.
3. Or you may directly use a screwdriver to remove the screws that secure the stand to the monitor, and detach the stand from the monitor.



- We recommend that you cover the table surface with soft cloth to prevent damage to the monitor.
- Hold the stand while removing the screws.

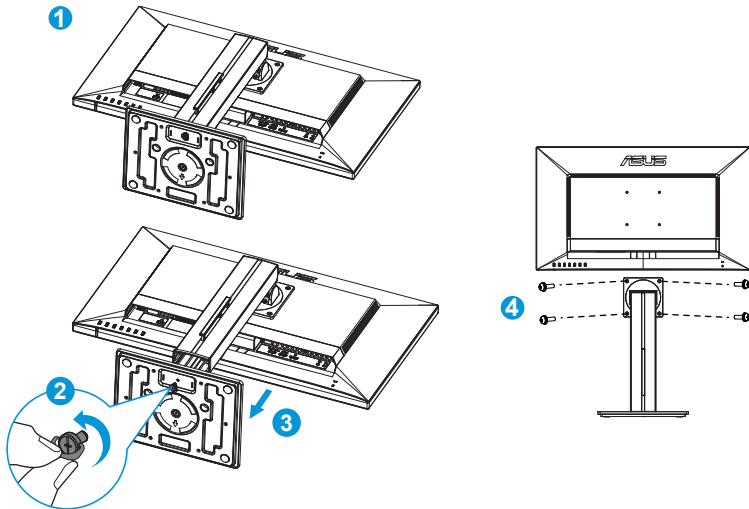

- The VESA wall mount kit (100 x 100 mm) is purchased separately.
- Use only the UL Listed Wall Mount Bracket with minimum weight/load 22.7kg (Screw size: M4 x 10 mm).

2.2 Adjusting the monitor

- For optimal viewing, we recommend that you look at the full face of the monitor, then adjust the monitor to the angle that is most comfortable for you.
- Hold the stand to prevent the monitor from falling while changing its angle.
- You can adjust the monitor's angle from -5° to 20° .

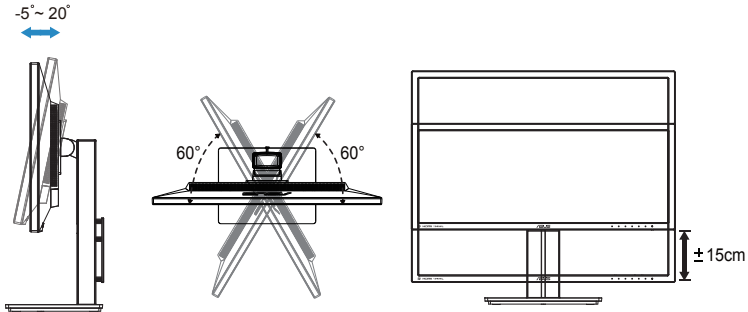

3.1 OSD (On-Screen Display) menu

3.1.1 How to reconfigure

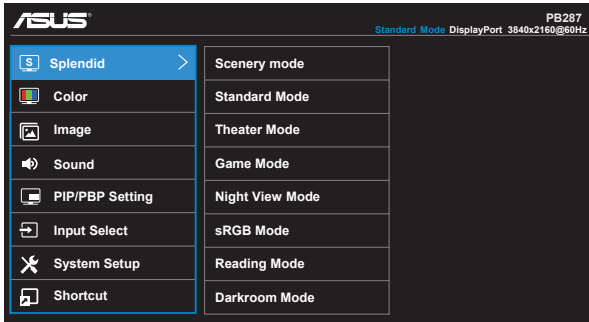

1. Press the MENU button to activate the OSD menu.
2. Press the ▼ and ▲ buttons to toggle between options in the Menu. As you move from one icon to another, the option name is highlighted.
3. To select the highlighted item on the menu press the ✓ button.
4. Press the ▼ and ▲ buttons to select the desired parameter.
5. Press the ✓ button to enter the slide bar and then use the ▼ or ▲ buttons, according to the indicators on the menu, to make your changes.
6. Select the ↶ to return to previous menu or ✓ to accept and return to previous menu.

3.1.2 OSD Function Introduction

1. Splendid

This function contains eight sub-functions that you can select for your preference. Each mode has the Reset selection, allowing you to maintain your setting or return to the preset mode.

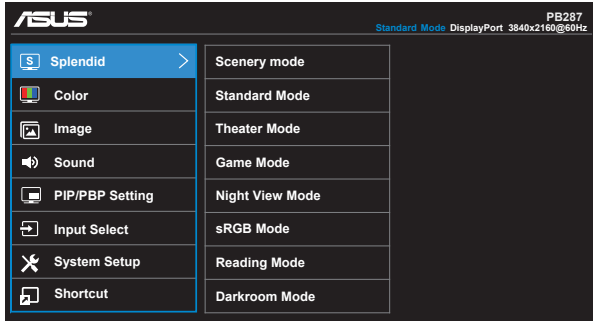

- **Scenery Mode:** This is the best choice for scenery photo displaying with SPLENDID™ Video Intelligence Technology.
- **Standard Mode:** This is the best choice for document editing with SPLENDID™ Video Intelligence Technology.
- **Theater Mode:** This is the best choice for movie watching with SPLENDID™ Video Intelligence Technology.
- **Game Mode:** This is the best choice for game playing with SPLENDID™ Video Intelligence Technology.
- **Night View Mode:** This is the best choice for playing dark-scene game or watching dark-scene movie with SPLENDID™ Video Intelligence Technology.
- **sRGB Mode:** This is the best choice for viewing photos and graphics from PCs.
- **Reading Mode:** This is the best choice for book reading.
- **Darkroom Mode:** This is the best choice for a weak ambient light environment.



-
- In the Standard Mode, the Saturation, SkinTone, Sharpness, and ASCR functions are not user-configurable.
 - In the sRGB, the Saturation, Color Temp., SkinTone, Sharpness, Brightness, Contrast and ASCR functions are not user-configurable.
 - In the Reading Mode, the Saturation, SkinTone, ASCR, contrast, and Color Temp functions are not user-configurable.
-

2. Color

Select the image color you like from this function.

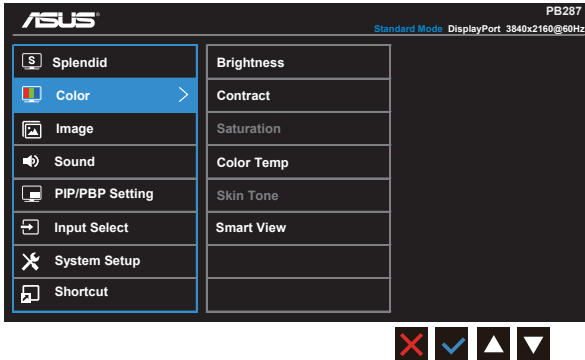

- **Brightness:** The adjusting range is from 0 to 100.
- **Contrast:** The adjusting range is from 0 to 100.
- **Saturation:** The adjusting range is from 0 to 100.
- **Color Temp.:** Contains three preset color modes (**Cool**, **Normal**, **Warm**) and **User Mode**.
- **Skin Tone:** Contains three color modes including **Reddish**, **Natural**, and **Yellowish**.
- **Smart View:** The versatile viewing positions with Smart View Technology



-
- In the User Mode, colors of R (Red), G (Green), and B (Blue) are user-configurable; the adjusting range is from 0 ~ 100.
-

3. Image

You can adjust the image Sharpness, Trace Free, Aspect Control, VividPixel, ASCR, from this main function.

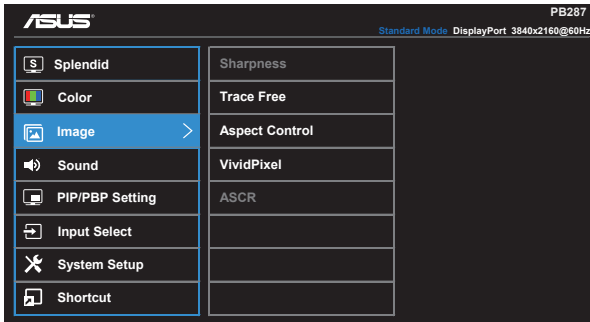

- **Sharpness:** Adjusts the picture sharpness. The adjusting range is from 0 to 100.
- **Trace Free:** Speeds up the response time by Over Drive technology. The adjusting range is from lower 0 to faster 100.
- **Aspect Control:** Adjusts the aspect ratio to “Full”, “4:3”, “1:1”, “Overscan”.
- **VividPixel:** ASUS Exclusive Technology that brings lifelike visuals for crystal-clear and detail-oriented enjoyment. The adjusting range is from 0 to 100.
- **ASCR:** Select **ON** or **OFF** to enable or disable dynamic contrast ratio function.

4. Sound

Adjust the sound settings to your preference.

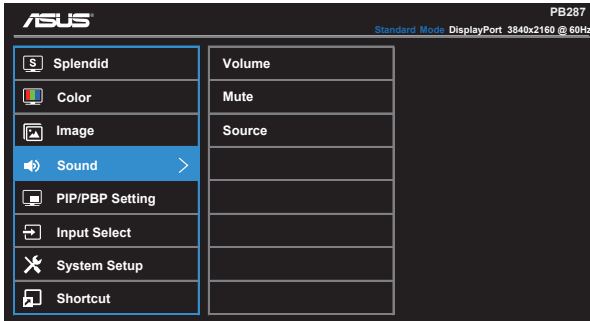

- **Volume:** Adjusts the output volume level.
- **Mute:** Mute the output volume.
- **Source:** Adjusts audio source to “Line In” or “HDMI” (only available for HDMI-1/MHL or HDMI-2 input); Adjusts audio source to “Line In” or “DisplayPort” (only available for DisplayPort input).

5. PIP/PBP Setting

The PIP/PBP Setting allows you to open up another sub-window connected from another video source besides the main-window from your original video source.

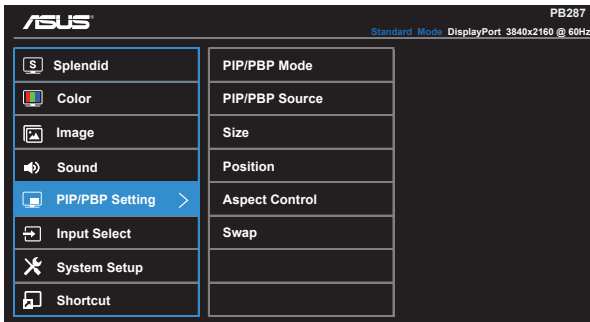

By activating this function, this monitor displays two pictures from two different video sources.

- **PIP/PBP Mode:** Selects PIP or PBP function, or turn it off.
- **PIP/PBP Source:** Selects the video input source among, “HDMI-1/MHL”, HDMI-2 or “DisplayPort”.
- **Size:** Adjust the PIP size to “Small”, “Middle”, or “Large”.
- **Position:** Adjusts the position of PIP sub-window to “Right-Top”, “Right-Bottom”.
- **Aspect Control:** Adjusts the PIP aspect ratio and automatically adjust the PIP window size.
- **Swap:** Swaps the sources of the main- and sub-windows.

		Main-window		
Sub-window	HDMI-1/MHL		YES	YES
	HDMI-2	YES		YES
	DisplayPort	YES	YES	



- PBP image is similar to input source

PIP mode main/sub source setting

Main Source	PIP Source	Support	Operating Instruction
Resolution A 3840x2160-30Hz 3840x2160-60Hz	Resolution A 3840x2160-30Hz 640x350-70Hz 720x400-70Hz	YES	
Any	3840x2160-60Hz	NO	If main source is HDMI-1, sub source is DisplayPort: 1. Activating the OSD, select the main source to DisplayPort 2. Change the PC DisplayPort resolution to 3840x2160-30Hz 3. Activating the OSD, select the main source to HDMI-1 PS: To get better view experience, to keep DisplayPort as main source is recommended
640x350-70Hz 720x400-70Hz	Any	NO	Before activating PIP function, user should enter into windows OS firstly.

PBP mode main/sub source setting

Main Source	PBP Source	Support	Operating Instruction
Resolution A 640x350-70Hz 720x400-70Hz	Resolution A 640x350-70Hz 720x400-70Hz	YES	
Resolution A 640x350-70Hz 720x400-70Hz	3840x2160-30Hz 3840x2160-60Hz	NO	If main source (left window) is HDMI-1, sub source is DisplayPort(right window): 1. Activating the OSD, turn off the PBP function 2. Select the input source to DisplayPort 3. Change the PC DisplayPort resolution to 1920x1080-60Hz 4. Activating the OSD,turn on the PBP function, and select the main/sub source you wanted.
3840x2160-30Hz 3840x2160-60Hz	Resolution A 640x350-70Hz 720x400-70Hz	NO	If main source(left window) is DisplayPort, sub source is HDMI-1(right window): 1. Activating the OSD, select the main source to HDMI-1 2. turn off the PBP function 3. Select the input source to DisplayPort 4. Change the PC DisplayPort resolution to 1920x1080-60Hz 5. Activating the OSD, turn on the PBP function, and select the main/sub source you wanted.
3840x2160-30Hz 3840x2160-60Hz	3840x2160-30Hz 3840x2160-60Hz	NO	If main source(left window) is DisplayPort, sub source is HDMI-1(right window): 1. Activating the PIP/PBP Setting shortcut OSD, turn off the PBP function 2. Change the PC DisplayPort resolution to 1920x1080-60Hz 3. Activating the OSD, select the main source to HDMI-1 4. Change the PC HDMI-1 resolution to 1920x1080-60Hz 5. Activating the OSD, turn on the PBP function, and select the main/sub source you wanted.
3840x2160-30Hz 3840x2160-60Hz	No signal	NO	If main source (left window) is DisplayPort, sub source is HDMI-1 or HDMI-2 (right window): 1. Activating the OSD, select the main source to HDMI-1 or HDMI-2 2. Activating the PIP/PBP Setting shortcut OSD, turn off the PBP function 3. Select the input source to DisplayPort 4. Change the PC DisplayPort resolution to 1920x1080-60Hz 5. Activating the OSD, turn on the PBP function, and select the main/sub source you wanted.



- To get better view experience, to keep DisplayPort as main source is recommended.
- Resolution A refers to the resolution which is equal or less than 1920x1080 and H frequency is equal or less than 60Hz.

6. Input Select

Select the input source from **HDMI-1/ MHL**, **HDMI-2** or **DisplayPort** input signal.

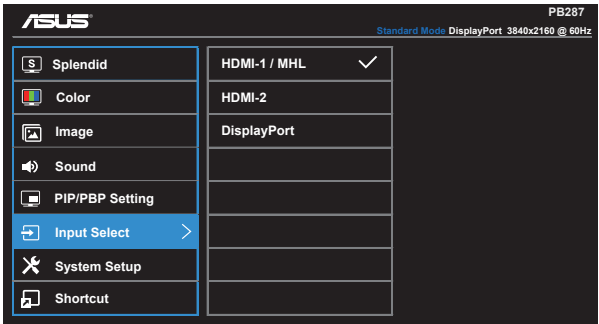

7. System Setup

Adjusts the system configuration.

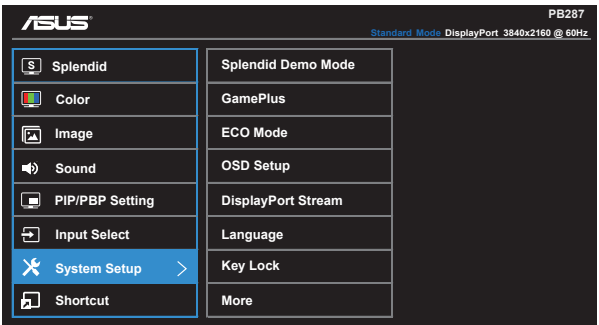

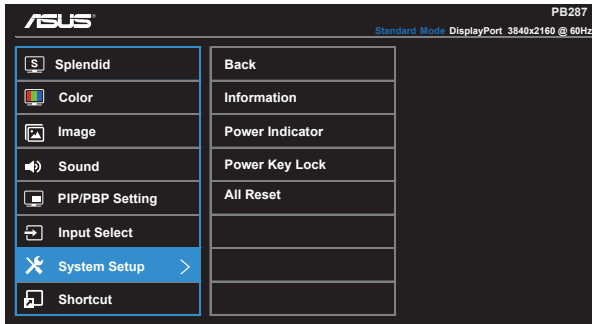

- **Splendid Demo Mode:** Activate the demo mode for the Splendid function.
- **GamePlus:** The GamePlus Function provides a toolkit and creates a better gaming environment for users when playing different types of games. Particularly, Aimpoint function is specially designed for new gamers or beginners interested in First Person Shooter (FPS) games.

To activate GamePlus:

- Select **ON** to enter the GamePlus main menu.
- Press ◀ and ▶ to select between Aimpoint and Timer function.
- Press ✓ to confirm the function you choose. Press ↶ to go back. Press ✗ to go off, and exit.

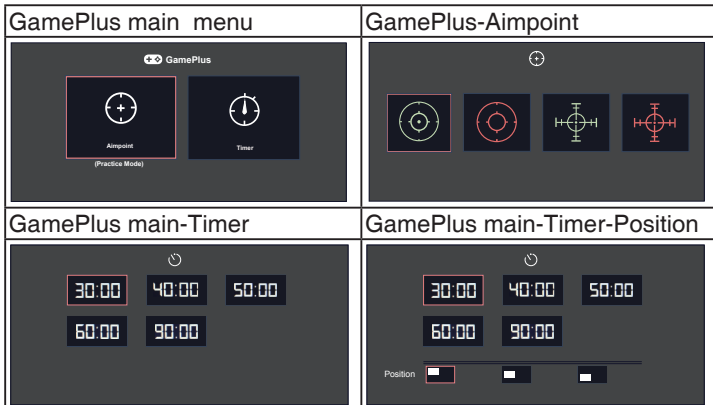

- **ECO Mode:** Activate the ecology mode for power saving.

- **OSD Setup:** Adjusts the **OSD Timeout**, **DDC/CI**, and **Transparency** of the OSD screen.
- **DisplayPort Stream:** Compatibility with graphic card. Select DP 1.1 or DP 1.2 by graphic card DP version. (3840x2160-60Hz is available at DP 1.2 only. The best resolution is 3840x2160-30Hz at DP 1.1). Follow the instructions below to change 4K2K, 30Hz to 4K2K, 60Hz on your PC: In Windows, right click the desktop and enter the Screen Resolution. Go to Advanced Settings, and set the refresh rate to 60Hz from 30Hz.
- **Language:** Select OSD language. The selections are: **English, French, German, Spanish, Italian, Dutch, Russian, Traditional Chinese, Simplified Chinese, Japanese, Persian, Thai, Indonesian, Poland, Turkey, Portugal, Czech, Croatia, Hungary, Romania, and Korean.**
- **Key Lock:** Disable all key functions. Pressing the second button on the right for more than five seconds to disable key lock function.
- **Information:** Displays the monitor information.
- **More:** Return the next page of System Setting.
- **Back:** Return the previous page of System Setting.
- **Power Indicator:** Turn the power LED indicator on/off.
- **Power Key Lock:** To disable / enable power key
- **All Reset:** Selects "**Yes**" to revert all settings to the factory default mode.

8. Shortcut

Selecting this option allows you to set two shortcut keys.

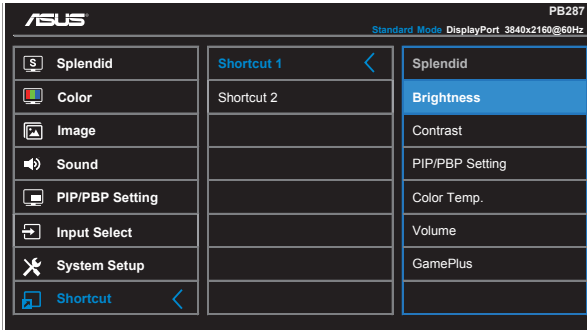

- **Shortcut 1:** User can select from “Splendid”, “Brightness”, “Contrast”, “PIP/PBP Setting”, “Color Temp.”, “Volume”, “GamePlus” and set as shortcut key. The default setting is Brightness.
- **Shortcut 2:** User can select from “Splendid”, “Brightness”, “Contrast”, “PIP/PBP Setting”, “Color Temp.”, “Volume”, “GamePlus” and set as shortcut key. The default setting is Splendid.

3.2 Specifications

Model	PB287Q
Panel Size	28" W (71.12 cm)
Max. Resolution	3840 x 2160
Brightness (Typ.)	300cd/m ²
Dynamic Contrast Ratio (Typ.)	≥ 100,000,000:1
Viewing Angle (CR ≤ 10)	170°(V); 160°(H)
Display Colors	1.073 G (Real 10 bit)
Response Time (Typ.)	≤ 1 ms (Gray to Gray)
D-Sub input	No
HDMI-1 / MHL input	Yes (MHL2.0)
Power ON Consumption	Power on<64 W*
Note	* Based on Energy Star 6.0 standard
Speaker	Yes (2W)
Earphone	Yes
Power saving mode	< 0.5 W
Power off mode	< 0.5 W
Tilt	-5° ~ +20°
VESA Wall Mounting	Yes (100mm x 100mm)
Phys. Dimension (WxHxD)	660.26 x 559.21(Lowest) x 220.06 mm
Box Dimension (WxHxD)	764 x 465 x 224 mm
Net Weight (Esti.)	7.9 kg
Gross Weight (Esti.)	10.6 kg
Voltage Rating	AC 100~240V(Built-in)

3.3 Troubleshooting (FAQ)

Problem	Possible Solution
Power LED is not ON	<ul style="list-style-type: none">• Press the  button to check if the monitor is in the ON mode.• Check if the power cord is properly connected to the monitor and the power outlet.• Check Power Indicator function in main menu OSD. Select "ON" to turn on power LED.
The power LED lights amber and there is no screen image	<ul style="list-style-type: none">• Check if the monitor and the computer are in the ON mode.• Make sure the signal cable is properly connected the monitor and the computer.• Inspect the signal cable and make sure none of the pins are bent.• Connect the computer with another available monitor to check if the computer is properly working.
Screen image is too light or dark	<ul style="list-style-type: none">• Adjust the Contrast and Brightness settings via OSD.
Screen image bounces or a wave pattern is present in the image	<ul style="list-style-type: none">• Make sure the signal cable is properly connected to the monitor and the computer.• Move electrical devices that may cause electrical interference.
Screen image has color defects (white does not look white)	<ul style="list-style-type: none">• Inspect the signal cable and make sure that none of the pins are bent.• Perform Reset via OSD.• Adjust the R/G/B color settings or select the Color Temperature via OSD.
No sound or sound is low	<ul style="list-style-type: none">• Make sure the audio cable is properly connected to the monitor.• Adjust the volume settings of both your monitor and computer.• Make sure the computer sound card driver is properly installed and activated.• Make sure the audio source is correct on the OSD.• Few players will not send the necessary information after their color input format are changed. This may lead to the abnormal color display. At this time, turn on/off the power again to correct this anomaly.

3.4 Supported Timing List

VESA / IBM Modes Support Timing

Resolution	Refresh Rate	Horizontal Frequency
640 x 350	70Hz	31.469KHz
640 x 480	60Hz	31.469KHz
720 x 400	70Hz	31.469KHz
800 x 600	56Hz	35.156KHz
800 x 600	60Hz	37.879KHz
1024 x 768	60Hz	48.363KHz
1280 x 720	60Hz	44.772KHz
1280 x 800	60Hz	49.702KHz
1280 x 960	60Hz	60KHz
1280 x 1024	60Hz	63.981KHz
1440 x 900	60Hz	55.935KHz
1680 x 1050	60Hz	65.29KHz
1920 x 1080	60Hz	67.5KHz
3840 x 2160	30Hz	67.5KHz
3840 x 2160 (DP)	60Hz	133.32KHz

HDMI 1.4 CEA-861 Formats Supported Timing

Resolution	Refresh Rate	Horizontal Frequency
640 x 480P	59.94 / 60Hz	31.469 / 31.5KHz
720 x 480P	59.94 / 60Hz	31.469 / 31.5KHz
720 x 576P	50Hz	31.25KHz
1280 x 720P	50Hz	37.5KHz
1280 x 720P	59.94 / 60Hz	44.955 / 45KHz
1440 x 480P	59.94 / 60Hz	31.469 / 31.5KHz
1440 x 576P	50Hz	31.25KHz
1920 x 1080i	50Hz	28.125KHz
1920 x 1080i	59.94 / 60Hz	33.716 / 33.75KHz
1920 x 1080P	30Hz	33.75KHz
1920 x 1080P	50Hz	56.25KHz
1920 x 1080P	59.94 / 60Hz	67.433 / 67.5KHz

* The modes not listed in the above tables may not be supported. For optimal resolution, we recommend that you choose a mode listed in the above tables.