

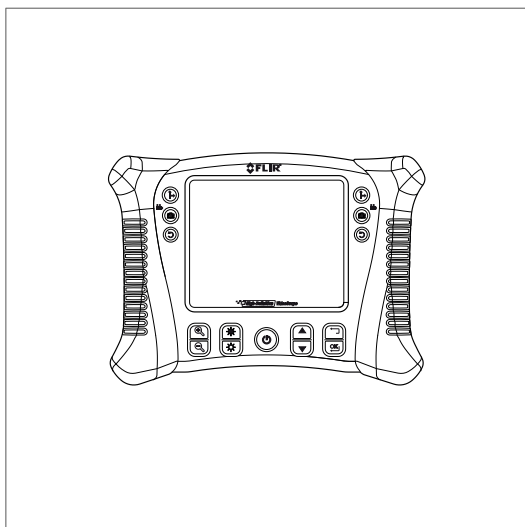

User's manual

FLIR VS70

High definition videoscope inspection camera





User's manual

FLIR VS70



Intertek™

Table of contents

1	Disclaimers	1
	1.1 Copyright.....	1
	1.2 Quality assurance	1
	1.3 Documentation updates	1
	1.4 Disposal of electronic waste.....	2
	1.5 FCC Compliance	2
	1.6 Industry Canada compliance.....	3
2	Safety information	4
3	Introduction	5
4	Description	6
	4.1 Monitor.....	6
	4.1.1 Function buttons	8
	4.1.2 Display icons	8
	4.2 Articulating probe.....	9
	4.3 Wireless transmitter	10
	4.4 Probe accessories.....	10
	4.5 Probe.....	11
5	Operation	12
	5.1 Basic operation	12
	5.1.1 Controlling the camera LED light intensity	12
	5.1.2 Taking a picture	12
	5.1.3 Recording a video.....	12
	5.2 Setup menu	13
	5.3 Factory Default Profiles menu.....	14
	5.4 Installing probe accessories.....	14
	5.5 Articulating probe.....	15
	5.5.1 Articulating probe—wireless version	15
	5.5.2 Articulating probe—direct version	16
	5.6 Wireless transmitter	17
	5.6.1 Wireless transmitter—wireless version.....	17
	5.6.2 Wireless transmitter—direct version	18
	5.7 Managing stored pictures and videos.....	19

Table of contents

	5.7.1	Viewing pictures and videos on the monitor display	19
	5.7.2	Transferring files to a PC	19
	5.7.3	Deleting the picture/video memory	20
	5.8	Video output to a TV or external monitor	20
	5.9	Reset	20
	5.10	Rear stand	20
6		Maintenance	21
	6.1	Cleaning	21
	6.2	Battery recharging	21
7		Technical specifications	22
	7.1	Monitor	22
	7.2	Transmitter	23
	7.3	Camera	23
	7.4	Probes and cameras	24
	7.5	Earphone	24
	7.6	Part numbers	24
8		Technical support for external meters	27
9		FLIR Test and Measurement Limited 2 Year Warranty	28

1 Disclaimers

1.1 Copyright

© 2016, FLIR Systems, Inc. All rights reserved worldwide. No parts of the software including source code may be reproduced, transmitted, transcribed or translated into any language or computer language in any form or by any means, electronic, magnetic, optical, manual or otherwise, without the prior written permission of FLIR Systems.

The documentation must not, in whole or part, be copied, photocopied, reproduced, translated or transmitted to any electronic medium or machine readable form without prior consent, in writing, from FLIR Systems.

Names and marks appearing on the products herein are either registered trademarks or trademarks of FLIR Systems and/or its subsidiaries. All other trademarks, trade names or company names referenced herein are used for identification only and are the property of their respective owners.

1.2 Quality assurance

The Quality Management System under which these products are developed and manufactured has been certified in accordance with the ISO 9001 standard.

FLIR Systems is committed to a policy of continuous development; therefore we reserve the right to make changes and improvements on any of the products without prior notice.

1.3 Documentation updates

Our manuals are updated several times per year, and we also issue product-critical notifications of changes on a regular basis.

To access the latest manuals and notifications, go to the Download tab at:

<http://support.flir.com>

It only takes a few minutes to register online. In the download area you will also find the latest releases of manuals for our other products, as well as manuals for our historical and obsolete products.

1 Disclaimers

1.4 Disposal of electronic waste



As with most electronic products, this equipment must be disposed of in an environmentally friendly way, and in accordance with existing regulations for electronic waste.

Please contact your FLIR Systems representative for more details.

1.5 FCC Compliance

This device complies with part 15 of the FCC Rules. Operation is subject to the following two conditions:

1. This device may not cause harmful interference.
2. This device must accept any interference received, including interference that may cause undesired operation.

This equipment has been tested and found to comply with the limits for a Class B digital device, pursuant to part 15 of the FCC Rules. These limits are designed to provide reasonable protection against harmful interference in a residential installation. This equipment generates, uses, and can radiate radio frequency energy and, if not installed and used in accordance with the instructions, may cause harmful interference to radio communications. However, there is no guarantee that interference will not occur in a particular installation. If this equipment does cause harmful interference to radio or television reception, which can be determined by turning the equipment off and on, the user is encouraged to try to correct the interference by one or more of the following measures:

- Reorient or relocate the receiving antenna.
- Increase the separation between the equipment and receiver.
- Connect the equipment into an outlet on a circuit different from that to which the receiver is connected.
- Consult the dealer or an experienced radio/TV technician for help.

1 Disclaimers



CAUTION

Exposure to Radio Frequency Radiation.

To comply with FCC/IC RF exposure compliance requirements, a separation distance of at least 20 cm must be maintained between the antenna of this device and all persons. This device must not be co-located or operating in conjunction with any other antenna or transmitter.



WARNING

Changes or modifications not expressly approved by the party responsible for compliance could void the user's authority to operate the equipment.

1.6 Industry Canada compliance

This device complies with Industry Canada licence-exempt RSS standard(s). Operation is subject to the following two conditions: (1) this device may not cause interference, and (2) this device must accept any interference, including interference that may cause undesired operation of the device.



CAUTION

Exposure to Radio Frequency Radiation.

To comply with RSS 102 RF exposure compliance requirements, for mobile configurations, a separation distance of at least 20 cm must be maintained between the antenna of this device and all persons. This device must not be co-located or operating in conjunction with any other antenna or transmitter.

2 Safety information

Note Before operating the device, you must read, understand, and follow all instructions, dangers, warnings, cautions, and notes.

Note FLIR Systems reserves the right to discontinue models, parts or accessories, and other items, or to change specifications at any time without prior notice.



WARNING

Make sure that children cannot touch the device. The device contains dangerous objects and small parts that children can swallow. If a child swallows an object or a part, speak with a physician immediately. Injury to persons can occur.



WARNING

Do not let children play with the packing material. These can be dangerous for children if they use them as toys.



CAUTION

For the Articulating Probe, do not operate the articulation knob with the probe in a coiled configuration. This will cause damage to the articulation controls.



This symbol, adjacent to another symbol or terminal, indicates that the user must refer to the manual for further information.



This symbol, adjacent to a terminal, indicates that, under normal use, hazardous voltages may be present.



Double insulation.

3 Introduction

Congratulations on your purchase of this FLIR VS70 video borescope.

This instrument is designed for use as a remote inspection device. It can be used to peer into tight spots, and record and playback real-time video and images. Typical applications include HVAC inspection, cable routing, and automotive/boat/aircraft inspection. The monitor is designed with dual left- or right-handed controls for maximum flexibility, and is available with a full line of accessories.

This borescope is shipped fully tested and, with proper use, will provide years of reliable service.

4 Description

4.1 Monitor

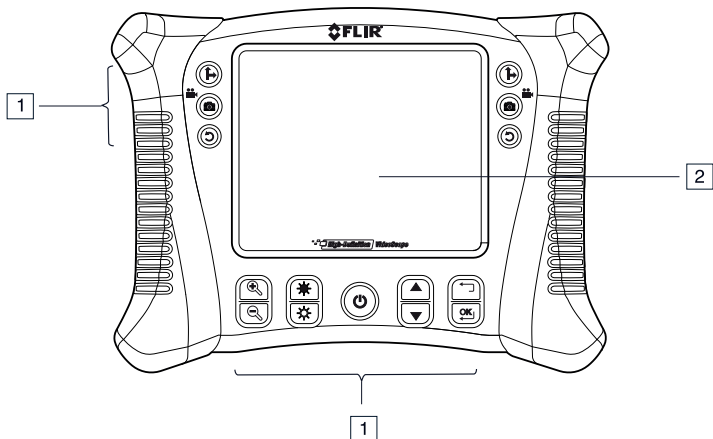

Figure 4.1 Monitor front view

1. Function buttons, see section 4.1.1 *Function buttons*, page 8.
2. Display.

4 Description

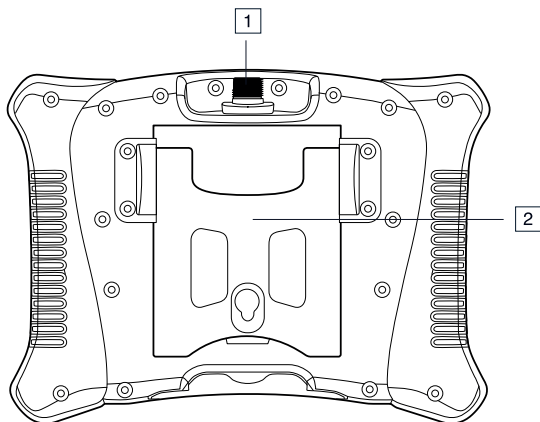

Figure 4.2 Monitor rear view

1. Probe connector.
2. Rear stand.

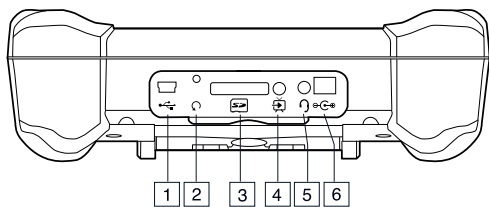











Figure 4.3 Monitor bottom view, with access cover removed



1. USB connector.
2. Reset button.
3. SD card slot.
4. Video output jack.
5. Headset jack (audio and mic).
6. AC adapter connector.

4 Description





4.1.1 Function buttons

	For two-camera probe, press the button to toggle between the side view and the front view camera lens.
	<ul style="list-style-type: none">• Press the button to take a picture.• Press and hold down the button for 3 seconds to start/stop recording a video.
	Press the button to rotate the display 90°.
	Press the buttons to increase/decrease the display resolution.
	Press the buttons to increase/decrease the camera LED light intensity.
	Press and hold down the button for 5 seconds to switch on/off the monitor.
	<ul style="list-style-type: none">• Press the buttons to navigate up/down in the setup menu.• Press the  button to access the picture/video memory.
	<ul style="list-style-type: none">• Press the button to open the setup menu.• Press the button to select the highlighted menu item.
	Press the button to exit the setup menu.

4.1.2 Display icons

	Indicates that a picture is being taken.
	Indicates that a video is being recorded.
	Indicates the battery voltage status.

4 Description

	Indicates that a stored picture is being displayed.
	Indicates that a stored video is being displayed.
	Indicates playback of a stored video.
	Indicates paused playback of a stored video.

4.2 Articulating probe

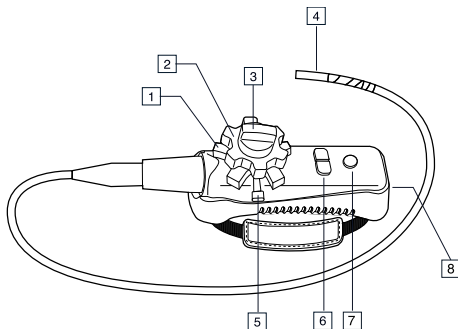

Figure 4.4 Articulating probe

1. Articulation knob (up/down).
2. Articulation knob (left/right).
3. Tension knob (left/right).
4. Articulating camera.
5. Tension knob (up/down).
6. Light intensity buttons.
7. Power button.
8. AC adaptor and extension cable sockets.

4 Description

4.3 Wireless transmitter

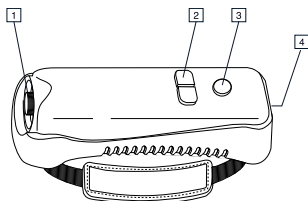

Figure 4.5 Wireless transmitter

1. Probe connector.
2. Light intensity buttons.
3. Power button.
4. AC adaptor and extension cable sockets.

4.4 Probe accessories

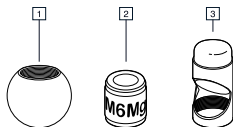

Figure 4.6 Probe accessories

1. Anti-slag tip.
2. Magnet.
3. 45° mirror.

4 Description

4.5 Probe

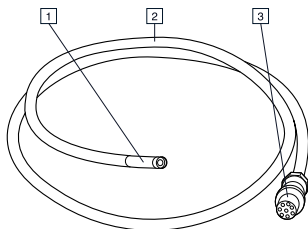







Figure 4.7 Probe

1. Camera.
2. Shaft.
3. Monitor connector.



5 Operation

5.1 Basic operation



1. Insert an SD card into the SD card slot, located on the bottom of the monitor.
2. Connect the probe to the monitor or turn on the wireless adapter if applicable.
3. Press and hold down the  button for 5 seconds to switch on the monitor.
4. If the battery indicator  shows that the battery voltage is low or if the monitor does not power on, recharge the battery. See section 6.2 *Battery recharging*, page 21.
5. Maneuver the probe into position to view the area to be examined. The probe can be bent into the shape of the area to be examined. The optimum focus distance is probe dependent.
6. For TWO-CAMERA PROBE, press the  button to toggle between the side view and the front view camera lens. Two-camera operation requires a direct connection of the dual channel cable (VSC2-58-1FM) to the VS70 monitor.
7. Use the  and  buttons to zoom in and out.

5.1.1 Controlling the camera LED light intensity

Note The camera LEDs become warm when set to maximum intensity.

1. In wireless mode, use the light intensity buttons on the articulating probe (see Figure 4.4 *Articulating probe*, page 9) or wireless transmitter (see Figure 4.5 *Wireless transmitter*, page 10) to increase/decrease the light intensity.
2. In direct mode, use the  and  buttons to increase/decrease the light intensity.





5.1.2 Taking a picture

1. Press the  button to take a picture and store it in the memory. The  icon is briefly displayed.

5.1.3 Recording a video

1. Audio can be recorded on the video via the microphone, located on the bottom of the monitor. For audio recording, remove the bottom access cover.





5 Operation

- Press and hold down the  button for 3 seconds (long press) to start the video recording. The   icons are displayed.
- While recording, you can take a picture by pressing the  button (short press).
- Press and hold down the  button for 3 seconds (long press) to stop the video recording.







5.2 Setup menu

Monitor settings are adjusted in the setup menu.

<i>DELETE ALL</i>	Delete all stored pictures and videos.
<i>VIDEO OUTPUT</i>	For two-camera probe, select the front view or the side view camera.
<i>DATE/TIME SETUP</i>	Select the date and time format, set the date and time, and select display on/off (when on, the date and time are shown on the display and on the pictures/videos).
<i>LANGUAGE</i>	Select the menu display language.
<i>VIDEO FORMAT</i>	Set the video output to NTSC or PAL format. Press either of the two camera buttons (upper right or upper left button) to access the <i>Factory Default</i> menu for camera brightness, contrast, hue, and saturation settings. See section 5.3 <i>Factory Default Profiles menu</i> , page 14 for more information.
<i>AUTO POWER OFF</i>	Set auto power off to 5, 10, 15, or 30 minutes or <i>DISABLE</i> .
<i>INPUT SOURCE</i>	Set the input source to <i>DIRECT</i> or <i>WIRELESS</i> .

- Press the  button to open the setup menu.
- Press the  or  button to navigate to the desired menu item.
- Press the  button to select the highlighted menu item.

5 Operation

4. Press the  or  button to scroll through the options in an open menu item.
5. Press the  or  button to increase/decrease the selected value.
6. Press the  button to exit without saving.
7. After a change, do one of the following:
 - Press the  button to save the changed value.
 - Press the  button to exit without saving.

Note After 10 seconds of inactivity, the setup menu will exit without saving any changes.

8. Press the  button to move up one step in the menu hierarchy and to exit the setup menu.

5.3 Factory Default Profiles menu

The FLIR VS70 has two factory default profiles (*Default1* and *Default2*) and one user profile for brightness, contrast, hue, and saturation camera settings. To access the *Factory Default* menu, follow this procedure:

1. Navigate to the the *VIDEO FORMAT* screen in the setup menu as explained in Section 5.2.
2. Press OK to open the *TV OUTPUT NTSC/PAL* selection screen
3. Press either of the camera buttons (top left or top right button) to access the *Factory Setup* screen; The user profile settings will be shown, these can be adjusted and saved by the user. Scroll down to *Default1* or *Default2* and press *OK* to use one of the factory default profiles.

5.4 Installing probe accessories

Three accessories (mirror, anti-slag tip, and magnet) are supplied with each probe.

5 Operation

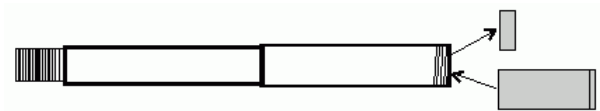

Figure 5.1 Installing probe accessories

1. Unscrew the probe ring.
2. Screw on the accessory.

5.5 Articulating probe

The articulating probe, with an adjustable tip angle, is used for improved viewing angles and optimum inspection when the probe is inserted into the area to be examined. The articulating probe is available in a direct (wired) or wireless version.

Turn the articulation knobs to adjust the camera tip. The tension of an articulation knob is adjusted by turning the corresponding tension knob. Refer to Figure 4.4 *Articulating probe*, page 9.

Note Do not operate the articulation knobs (see Figure 4.4 *Articulating probe*, page 9) with the probe in a coiled configuration. This will damage the articulation controls.

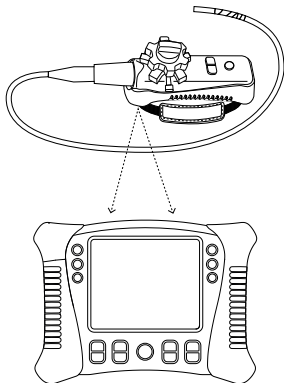

5.5.1 Articulating probe—wireless version



5 Operation

Note The articulating probe battery must be fully charged for wireless operation. A weak battery may result in shut down of data transmission.

Note The FLIR VS70 wireless operation transmits on 2.4 GHz which may interfere with other equipment operating on this same frequency.

1. Connect the AC adaptor to the articulating probe and charge the battery if necessary.
2. On the monitor, press and hold down the  button for 5 seconds to switch on the monitor.
3. In the setup menu under *INPUT SOURCE*, select *WIRELESS*. Refer to section 5.2 *Setup menu*, page 13.
4. On the articulating probe, press and hold down the  button for 5 seconds to switch on the articulating probe. The camera video is displayed on the monitor display.
5. Insert the probe into the area to be examined. Adjust the camera tip to the required viewing angle.

5.5.2 Articulating probe—direct version

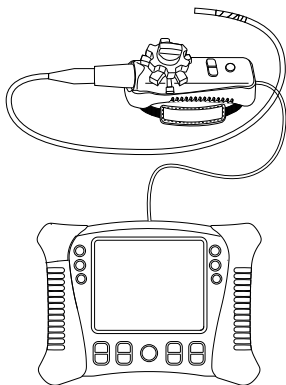

1. Connect the articulating probe to the probe connector on the monitor, using the supplied patch cable.

5 Operation

2. On the monitor, press and hold down the  button for 5 seconds to switch on the monitor. The camera video is displayed on the monitor display.
3. In the setup menu under *INPUT SOURCE*, select *DIRECT*. Refer to section 5.2 *Setup menu*, page 13.
4. Insert the probe into the area to be examined. Adjust the camera tip to the required viewing angle.

5.6 Wireless transmitter

The wireless transmitter is intended for use in areas that are difficult to access or in situations where it is hard to maneuver the probe with the display attached. The wireless transmitter can also be connected directly to the monitor using the patch cord.

5.6.1 Wireless transmitter—wireless version

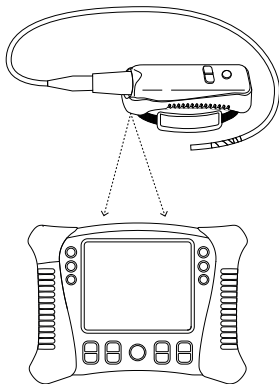



Note The wireless transmitter battery must be fully charged for wireless operation. A weak battery may result in shut down of the transmitter.

Note The FLIR VS70 wireless operation transmits on 2.4 GHz which may interfere with other equipment operating on this same frequency.

1. Connect the AC adaptor to the wireless transmitter and charge the battery.
2. Attach the probe to the wireless transmitter.

5 Operation

3. On the monitor, press and hold down the  button for 5 seconds to switch on the monitor.
4. In the setup menu under *INPUT SOURCE*, select *WIRELESS*. Refer to section 5.2 *Setup menu*, page 13.
5. On the wireless transmitter, press and hold down the  button for 5 seconds to switch on the transmitter. The camera video is displayed on the monitor display.



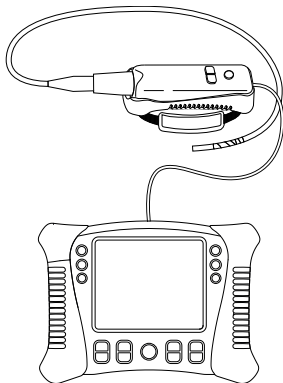

5.6.2 Wireless transmitter—direct version











1. Attach the probe to the wireless transmitter.
2. Connect the wireless transmitter to the probe connector on the monitor, using the supplied patch cable.
3. On the wireless transmitter, press and hold down the  button for 5 seconds to switch on both the transmitter and the monitor. The camera video is displayed on the monitor display.
4. In the setup menu under *INPUT SOURCE*, select *DIRECT*. Refer to section 5.2 *Setup menu*, page 13.

5.7 Managing stored pictures and videos

5.7.1 Viewing pictures and videos on the monitor display

1. Press the  button to access the pictures and videos in the memory.
2. Thumbnails of the pictures and videos are displayed. The  icon is displayed on video thumbnails.
3. Use the  and  buttons to navigate through the picture/video thumbnails. The selected picture/video is framed.
4. To open the selected picture/video file, press the  button.

The file number (e.g., IMG00005) and the  icon (for pictures) or the  icon (for videos) are displayed.

5. To start playback of an open video file, press the  button. The  icon is displayed.
6. To pause the playback of a video, press the  button. The  icon is displayed.
7. To exit an open picture/video, press the  button.
8. To exit the picture/video file memory, press the  button.

5.7.2 Transferring files to a PC

There are two methods for transferring stored picture/video files to a PC:

- Remove the SD card from the monitor and insert it into the PC.
- Connect the monitor to the PC with a USB cable.

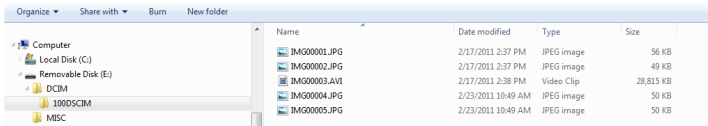

Name	Date modified	Type	Size
IMG00001.JPG	2/17/2011 2:37 PM	JPEG image	56 KB
IMG00002.JPG	2/17/2011 2:37 PM	JPEG image	49 KB
IMG00003.AVI	2/17/2011 2:38 PM	Video Clip	28,815 KB
IMG00004.JPG	2/23/2011 10:49 AM	JPEG image	50 KB
IMG00005.JPG	2/23/2011 10:49 AM	JPEG image	50 KB



Pictures are saved in *.JPG format and videos in *.AVI format.

5 Operation

5.7.3 Deleting the picture/video memory

1. In the setup menu, select *DELETE ALL*. Refer to section 5.2 *Setup menu*, page 13.

The *ERASE YES/NO* box appears.

2. Press the  button to select *YES*. Press the  button to delete all files in the memory.

Press the  button to exit without deleting the file.

5.8 Video output to a TV or external monitor

The monitor can be set to output the high-quality video to a TV or other external video monitor.

1. In the setup menu under *VIDEO FORMAT*, select *PAL* or *NTSC* to match the TV/external monitor to be used. Refer to section 5.2 *Setup menu*, page 13.
2. Connect the video cable to the video output jack, located on the bottom of the monitor. Connect the other end of the cable to the video input jack of the TV or other external monitor.

The high-quality video image is displayed on the TV/external monitor.

5.9 Reset

If the monitor becomes unresponsive due to electromagnetic interference or other magnetic event, use a paper clip or other narrow object to press the Reset button, located on the bottom of the monitor.

5.10 Rear stand

The rear stand can be set to three positions: lower position (stored), middle position for bench viewing, and upper position for hanging.

6 Maintenance

6.1 Cleaning

Clean the monitor, articulating probe, wireless transmitter, and accessories with a damp cloth and mild detergent; do not use abrasives or solvents.

6.2 Battery recharging

1. Ensure that the monitor is switched off.
2. Connect the AC adaptor to the monitor.

3. After several hours, press the  button to switch on the monitor.

The battery voltage status is indicated on the display:

- The battery is fully charged: 
- The battery charging is still in process:

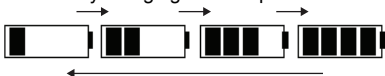

4. If the battery is fully charged, remove the AC adaptor and observe that the fully charged four-bar indicator appears: 

5. If the battery is not fully charged, press the  button to switch off the monitor and continue charging.

Note The battery will not charge properly if the monitor is switched on during the charging cycle.

Note If the battery fails to charge, please contact FLIR Systems for battery replacement service. In order to maintain IP rating, the battery must be replaced by authorized FLIR service personnel.

7 Technical specifications

7.1 Monitor

LCD screen	145 mm (5.7"); viewable: 135 mm (5.3") Active matrix, 640 × 480 pixels
Interface	Mini USB 1.1 and AV out
Recording medium	SD card
SD memory	4 GB standard (32 GB maximum)
Compression format	MPEG4
Still image format	JPEG (640 × 480)
Video recording format	AVI (640 × 480)
Video output format	NTSC and PAL; Frame rate 30 fps
Receiver frequency	2.4 GHz
Receiver sensitivity	-87 dBm (SNR = 42 dB, $F_{\text{mod}} = 15$ kHz)
Video system	NTSC/PAL
Data	Video/audio
Audio type	Stereo
Tripod mount	On rear, accepts standard tripod screw
Battery	3.7 V rechargeable lithium polymer
Power adaptor	100–240 V input/5 V DC output
Ingress Protection	IP67
Operating temperature	-10 to 60°C (14 to 140°F)
Storage temperature	-40 to 80°C (-40 to 176°F)
Operating humidity (maximum)	80%

7 Technical specifications

Dimensions (W × D × H)	241 mm × 178 mm × 70 mm (9.5" × 7" × 2.75")
Weight	1.57 kg (3.46 lb.), including batteries

7.2 Transmitter

Frequency	2.4 GHz
Data	Video/audio
Video system	NTSC/PAL
Battery	3.7 V rechargeable lithium polymer
Power adaptor	100–240 V input/9 V DC output
Unobstructed effective range	10 m (32.5')
Operating temperature	–10 to 60°C (14 to 140°F)
Storage temperature	–40 to 80°C (–40 to 176°F)
Dimensions (W × D × H)	190 mm × 70 mm × 63.5 mm (7.5" × 2.75" × 2.5")
Weight (approximate)	0.43 kg (0.95 lb)

7.3 Camera

Imaging Sensor	CMOS
Video Format	NTSC
Brightness Control	Manual
Lamp Type	LED
Interface	Composite video
Ingress Protection	IP67
Operating Temperature	–10°C to 50°C (14 to 122°F)

7 Technical specifications

7.4 Probes and cameras

Articulation	240 ± 20° manual tip articulation
Accessories	Mirror, magnet and anti-snag ball (excluding 25 mm diameter cables)

7.5 Earphone

Plug	<ul style="list-style-type: none">• 3.5 mm (0.14")• 4 rings
Speaker	<ul style="list-style-type: none">• 15 mm (0.59")• 32 Ω• 20~20 kHz
Microphone	6 × 5 mm (0.24" × 0.2")
Boom microphone, total length	10 cm (3.9")
Color	Black
Wire length	1.2 m (3.9')

7.6 Part numbers

Part number	Field of view	Description
VST	-	Wireless 2.4 GHz VS70 transmitter
VSA2-1-w	56°	Wireless 2-way 6 mm (0.24") articulating camera with 1 m (3.3') probe
VSA2-2-w	56°	Wireless 2-way articulating camera with 2 m (6.6') probe
VSA2-1	56°	2-way 6 mm (0.24") articulating camera with 1 m (3.3') probe
VSA2-2	56°	2-way 6 mm (0.24") articulating camera with 2 m (6.6') probe

7 Technical specifications

Part number	Field of view	Description
VSC3.9-1FM	53°	3.9 mm (0.15") camera with 1 m (3.3') flexible probe – QVGA via SF
VSC4.1-2RM	53°	4.1 mm (0.16") camera with 2 m (6.6') SR probe – QVGA via SF
VSC5.8-1RM	56°	5.8 mm (0.23") camera with 1 m (3.3') SR probe – VGA via SF
VSC5.8-2RM	56°	5.8 mm (0.23") camera with 2 m (6.6') SR probe – VGA via SF
VSC5.8-1R	56°	5.8 mm (0.23") camera with 1 m (3.3') SR probe – VGA via LF
VSC5.8-2R	56°	5.8 mm (0.23") camera with 2 m (6.6') SR probe – VGA via LF
VSC5.8-20	56°	5.8 mm (0.23") camera with 20 m (66') FG probe – VGA via LF
VSC5.8-30	56°	5.8 mm (0.23") camera with 30 m (98') FG probe – VGA via LF
VSC8.0-1R	56°	8 mm (0.31") camera with 1 m (3.3') SR probe – VGA via LF
VSC8.0-2R	56°	8 mm (0.31") camera with 2 m (6.6') SR probe – VGA via LF
VSC6.5-12S	56°	6.5 mm (0.26") camera with 0.30 m (12") SS rigid probe – VGA via SF
VSC6.5-17S	56°	6.5 mm (0.26") camera with 0.43 m (17") SS rigid probe – VGA via SF
VSS-20	-	Plumbing spool 20 m (66')
VSS-30	-	Plumbing spool 30 m (98')

7 Technical specifications

Part number	Field of view	Description
VSC25	72°	25 mm (0.98") camera with FG detachable probe – VGA via LF
VSC28	110°	28 mm (1.1") camera with FG detachable probe – VGA via LF

8 Technical support for external meters

Website	http://www.flir.com/test
Technical support	TMSupport@flir.com
Repairs	Repair@flir.com
Phone number	+1 855-499-3662 (toll-free)

9 FLIR Test and Measurement Limited 2 Year Warranty

A qualifying FLIR Test and Measurement product (the "Product") purchased either directly from FLIR Commercial Systems Inc and affiliates (FLIR) or from an authorized FLIR distributor or reseller that Purchaser registers on-line with FLIR is eligible for coverage under FLIR's Limited Warranty, subject to the terms and conditions in this document. This warranty only applies to purchases of Qualifying Products (see below) purchased and manufactured after April 1, 2013.

PLEASE READ THIS DOCUMENT CAREFULLY; IT CONTAINS IMPORTANT INFORMATION ABOUT THE PRODUCTS THAT QUALIFY FOR COVERAGE UNDER THE LIMITED WARRANTY, PURCHASER'S OBLIGATIONS, HOW TO ACTIVATE THE WARRANTY, WARRANTY COVERAGE, AND OTHER IMPORTANT TERMS, CONDITIONS, EXCLUSIONS AND DISCLAIMERS.

1. PRODUCT REGISTRATION. To qualify for FLIR's Limited Warranty, Purchaser must fully register the Product directly with FLIR on-line at <http://www.flir.com> within Sixty (60) DAYS of the date the Product was purchased by the first retail customer (the "Purchase Date"). Qualifying PRODUCTS THAT ARE NOT REGISTERED ON-LINE WITHIN SIXTY (60) DAYS OF THE PURCHASE DATE WILL HAVE A LIMITED ONE YEAR WARRANTY FROM DATE OF PURCHASE.

2. QUALIFYING PRODUCTS. Upon registration, Test and Measurement products that qualify for coverage under FLIR's Limited Warranty are: VS70 Videoscope, VSAxx Articulation Camera, VSCxx Camera, VSSxx Probe Spool, VST handset, MR02 Pin Extension Probe, and TAxX not including accessories which may have their own warranty.

3. WARRANTY PERIODS. The applicable Limited Warranty Period measured from the Purchase data are:

Products	Limited Warranty Period
VS70, VSAxx, VSCxx, VSSxx, VST, MR02, TAxX	TWO (2) Years

Any Product that is repaired or replaced under warranty is covered under this Limited Warranty for one hundred eighty days (180) days from the date of return shipment by FLIR or for the remaining duration of the applicable Warranty Period, whichever is longer.

4. LIMITED WARRANTY. In accordance with the terms and conditions of this Limited Warranty, and except as excluded or disclaimed in this document, FLIR warrants, from the Purchase Date, that all fully registered Products will conform to FLIR's published product specifications and be free from defects in materials and workmanship during the applicable Warranty Period. PURCHASER'S SOLE AND EXCLUSIVE REMEDY UNDER THIS

WARRANTY, AT FLIR'S SOLE DISCRETION, IS THE REPAIR OR REPLACEMENT OF DEFECTIVE PRODUCTS IN A MANNER, AND BY A SERVICE CENTER, AUTHORIZED BY FLIR. IF THIS REMEDY IS ADJUDICATED TO BE INSUFFICIENT, FLIR SHALL REFUND PURCHASER'S PAID PURCHASE PRICE AND HAVE NO OTHER OBLIGATION OR LIABILITY TO BUYER WHATSOEVER.

5. WARRANTY EXCLUSIONS AND DISCLAIMERS. FLIR MAKES NO OTHER WARRANTY OF ANY KIND WITH RESPECT TO THE PRODUCTS. ALL OTHER WARRANTIES, EXPRESS OR IMPLIED, INCLUDING BUT NOT LIMITED TO IMPLIED WARRANTIES OF MERCHANTABILITY, FITNESS FOR A PARTICULAR PURPOSE (EVEN IF PURCHASER HAS NOTIFIED FLIR OF ITS INTENDED USE FOR THE PRODUCTS), AND NON-INFRINGEMENT ARE EXPRESSLY EXCLUDED FROM THIS AGREEMENT.

THIS WARRANTY EXPRESSLY EXCLUDES ROUTINE PRODUCT MAINTENANCE, SOFTWARE UPDATES, AND REPLACEMENT OF FUSES, OR DISPOSABLE BATTERIES. FLIR FURTHER EXPRESSLY DISCLAIMS ANY WARRANTY COVERAGE WHERE THE ALLEGED NONCONFORMITY IS DUE TO NORMAL WEAR AND TEAR, OTHER ALTERATION, MODIFICATION, REPAIR, ATTEMPTED REPAIR, IMPROPER USE, IMPROPER MAINTENANCE, NEGLECT, ABUSE, IMPROPER STORAGE, FAILURE TO FOLLOW ANY PRODUCT INSTRUCTIONS, DAMAGE (WHETHER CAUSED BY ACCIDENT OR OTHERWISE), OR ANY OTHER IMPROPER CARE OR HANDING OF THE PRODUCTS CAUSED BY ANYONE OTHER THAN FLIR OR FLIR'S EXPRESSLY AUTHORIZED DESIGNEE.

THIS DOCUMENT CONTAINS THE ENTIRE WARRANTY AGREEMENT BETWEEN PURCHASER AND FLIR AND SUPERSEDES ALL PRIOR WARRANTY NEGOTIATIONS, AGREEMENTS, PROMISES AND UNDERSTANDINGS BETWEEN PURCHASER AND FLIR. THIS WARRANTY MAY NOT BE ALTERED WITHOUT THE EXPRESS WRITTEN CONSENT OF FLIR.

6. WARRANTY RETURN, REPAIR AND REPLACEMENT. To be eligible for warranty repair or replacement, Purchaser must notify FLIR within thirty (30) days of discovering of any apparent defect in materials or workmanship. Before Purchaser may return a Product for warranty service or repair, Purchaser must first obtain a returned material authorization (RMA) number from FLIR. To obtain the RMA number Owner must provide an original proof of purchase. For additional information, to notify FLIR of an apparent defect in materials or workmanship, or to request an RMA number, visit <http://www.flir.com>. Purchaser is solely responsible for complying with all RMA instructions provided by FLIR including but not limited to adequately packaging the Product for shipment to FLIR and for all packaging and shipping costs. FLIR will pay for returning

9 FLIR Test and Measurement Limited 2 Year Warranty

to Purchaser any Product that FLIR repairs or replaces under warranty.

FLIR reserves the right to determine, in its sole discretion, whether a returned Product is covered under Warranty. If FLIR determines that any returned Product is not covered under Warranty or is otherwise excluded from Warranty coverage, FLIR may charge Purchaser a reasonable handling fee and return the Product to Purchaser, at Purchaser's expense, or offer Purchaser the option of handling the Product as a non-warranty return.

7. NON-WARRANTY RETURN. Purchaser may request that FLIR evaluate and service or repair a Product not covered under warranty, which FLIR may agree to do in its sole discretion. Before Purchaser returns a Product for non-warranty evaluation and repair, Purchaser must contact FLIR by visiting <http://www.flir.com> to request an evaluation and obtain an RMA. Purchaser is solely

responsible for complying with all RMA instructions provided by FLIR including but not limited to adequately packaging the Product for shipment to FLIR and for all packaging and shipping costs. Upon receipt of an authorized non-warranty return, FLIR will evaluate the Product and contact Purchaser regarding the feasibility of and the costs and fees associated with Purchaser's request. Purchaser shall be responsible for the reasonable cost of FLIR's evaluation, for the cost of any repairs or services authorized by Purchaser, and for the cost of repackaging and returning the Product to Purchaser.

Any non-warranty repair of a Product is warranted for one hundred eighty days (180) days from the date of return shipment by FLIR to be free from defects in materials and workmanship only, subject to all of the limitations, exclusions and disclaimers in this document.

A note on the technical production of this publication

This publication was produced using XML — the eXtensible Markup Language. For more information about XML, please visit <http://www.w3.org/XML/>

A note on the typeface used in this publication

This publication was typeset using Linotype Helvetica™ World. Helvetica™ was designed by Max Miedinger (1910–1980)

LOEF (List Of Effective Files)

T501026.xml; en-US; AE; 36943; 2016-08-19



Website

<http://www.flir.com>

Customer support

<http://support.flir.com>

Copyright

© 2016, FLIR Systems, Inc. All rights reserved worldwide.

Disclaimer

Specifications subject to change without further notice. Models and accessories subject to regional market considerations. License procedures may apply. Products described herein may be subject to US Export Regulations. Please refer to exportquestions@flir.com with any questions.

Publ. No.: T559827
Release: AE
Commit: 36943
Head: 36943
Language: en-US
Modified: 2016-08-19
Formatted: 2016-08-19



T559827