

brother

TZe
TAPE**HGe**
TAPE**HS**
TUBE

QUICK SETUP GUIDE

P-touch
ELECTRONIC LABELING SYSTEM

PT-E550W

P-touch EDGE



Read this guide before you start using your P-touch labeling system.

Keep this guide in a handy place for future reference.

Please visit us at <http://solutions.brother.com/> where you can get product support and answers to frequently asked questions (FAQs).



INTRODUCTION

Thank you for purchasing the P-touch labeling system model PT-E550W. Your new PT-E550W is an intuitive, easy to operate and feature rich labeler that produces professional looking and high quality labels. This manual contains various precautions and basic procedures for using the P-touch labeling system. Read this manual carefully before using and keep in a handy place for future reference.

Available Manuals

The following manuals are available for this P-touch labeling system. The latest manuals can be downloaded from the Brother Solutions Center at <http://solutions.brother.com/>

Quick Setup Guide (this guide)

This guide provides information you should read before using the P-touch labeling system, such as setting up the machine.

User's Guide (PDF manual on the included CD-ROM)

This guide provides basic information about using the P-touch labeling system along with detailed troubleshooting tips.

Network User's Guide for E550W

This guide provides information about the network settings. This guide can be downloaded from the Brother Solutions Center at <http://solutions.brother.com/>

Available Applications for Use with Computers

P-touch Editor

P-touch Transfer Manager

P-touch Update Software

Refer to "Using P-touch Software" on page 44 for details.

Available Applications for Use with Mobile Devices

Brother offers various applications for use with the P-touch labeling system, including applications that allow you to print directly from your Apple iPhone, iPad, and iPod touch or Android™ smartphone, and applications that allow you to transfer data, such as templates, symbols, and databases that were created using a computer, to the P-touch labeling system wirelessly.

The Brother applications can be downloaded free-of-charge from the App Store or Google Play.

Software Development Kits

A software development kit (SDK) is available. Visit the Brother Developer Center (<http://www.brother.com/product/dev/index.htm>).

CAUTION

RISK OF EXPLOSION IF BATTERY IS REPLACED BY AN INCORRECT TYPE.
DISPOSE OF USED BATTERIES ACCORDING TO THE INSTRUCTIONS.

ATTENTION

RISQUE D'EXPLOSION SI LA BATTERIE EST REMPLACÉE PAR UN MODÈLE
INADÉQUAT.
MISE AU REBUT DES BATTERIES USAGÉES CONFORMÉMENT AUX
INSTRUCTIONS.

Federal Communications Commission (FCC) Declaration of Conformity (For USA Only)

Responsible Party: Brother Mobile Solutions, Inc.
100 Technology Drive Suite 250A
Broomfield, CO 80021 U.S.A.
Tel: (303) 460-1600

Product Name: Brother P-touch Electronic Labeling System
Model Number: PT-E550W

This device complies with Part 15 of the FCC Rules. Operation is subject to the following two conditions: (1) this device may not cause harmful interference, and (2) this device must accept any interference received, including interference that may cause undesired operation.

PT-E550W is equipped with FCC ID:B3Q8VA633.

This equipment has been tested and found to comply with the limits for a Class B digital device, pursuant to Part 15 of the FCC Rules. These limits are designed to provide reasonable protection against harmful interference in a residential installation. This equipment generates, uses and can radiate radio frequency energy and, if not installed and used in accordance with the instructions, may cause harmful interference to radio communications. However, there is no guarantee that interference will not occur in a particular installation. If this equipment does cause harmful interference to radio or television reception, which can be determined by turning the equipment off and on, the user is encouraged to try to correct the interference by one or more of the following measures:

- Reorient or relocate the receiving antenna.
- Increase the separation between the equipment and receiver.
- Connect the equipment into an outlet on a circuit different from that to which the receiver is connected.
- Consult the dealer or an experienced radio/TV technician for help.
- This transmitter must not be co-located or operated in conjunction with any other antenna or transmitter.

Important

- The enclosed interface cable should be used in order to ensure compliance with the limits for a Class B digital device.
- Changes or modifications not expressly approved by Brother Industries, Ltd. could void the user's authority to operate the equipment.

* In case WLAN Interface is in use.

CAUTION: To maintain compliance with FCC's RF exposure guidelines, use only the supplied antenna. Unauthorized antenna, modification, or attachments could damage the transmitter and may violate FCC regulations.

ATTENTION: (For USA and Canada)

The Lithium Ion battery you have purchased is recyclable. At the end of its useful life, under various state and local laws, it is illegal to dispose of this battery into your municipal waste stream. Please call 1-800-8-BATTERY



The available scientific evidence does not show that any health problems are associated with using low power wireless devices. There is no proof, however, that these low power wireless devices are absolutely safe. Low power Wireless devices emit low levels of radio frequency energy (RF) in the microwave range while being used. Whereas high levels of RF can produce health effects (by heating tissue), exposure of low-level RF that does not produce heating effects causes no known adverse health effects. Many studies of low-level RF exposures have not found any biological effects. Some studies have suggested that some biological effects might occur, but such findings have not been confirmed by additional research. PT-E550W has been tested and found to comply with FCC radiation exposure limits set forth for an uncontrolled environment and meets the FCC radio frequency (RF) Exposure Guidelines.

Open Source Licensing Remarks

This product includes open-source software.

To see the open source licensing remarks, please go to the manual download selection on your model's home page of Brother Solutions Center at <http://solutions.brother.com/>

International ENERGY STAR® Compliance Statement

The purpose of the International ENERGY STAR® Program is to promote the development and popularization of energy-efficient office equipment. As an ENERGY STAR® Partner, Brother Industries, Ltd. has determined that this product meets the ENERGY STAR® guidelines for energy efficiency.



Compilation and Publication Notice

Under the supervision of Brother Industries, Ltd., this manual has been compiled and published covering the latest product's descriptions and specifications.

The contents of this manual and the specifications of this product are subject to change without notice.

If new versions of the PT-E550W operating system becomes available, this manual may not reflect the updated features. Therefore, you may find that new operating system and the contents in this manual may be different.

Any trade names and product names of companies appearing on Brother products, related documents and any other materials are all trademarks or registered trademarks of those respective companies.

Trademarks and Copyrights

Brother is a trademark of Brother Industries, Ltd.

P-TOUCH is a trademark or registered trademark of Brother Industries, Ltd.

© 2014 Brother Industries, Ltd. All rights reserved.

Microsoft, Windows Vista, Windows Server and Windows are either registered trademarks or trademarks of Microsoft Corp. in the United States and/or other countries.

Apple, Macintosh, Mac OS, iPhone, iPad and iPod are trademarks of Apple Inc., registered in the United States and other countries.

The names of other software or products used in this document are trademarks or registered trademarks of the respective companies that developed them.

Wi-Fi and Wi-Fi Alliance are registered trademarks of the Wi-Fi Alliance.

Each company whose software title is mentioned in this manual has a Software License Agreement specific to its proprietary programs.

Any trade names and product names of companies appearing on Brother products, related documents and any other materials are all trademarks or registered trademarks of those respective companies.

Important Information

Should you have questions, or need information about your Brother Product, we have a variety of support options for you to choose from:

Customer Service
1-800-255-0415

Customer Service
1-303-460-1628 (fax)

World Wide Web
For purchasing accessories and certain Brother products:
<http://www.brothermobilesolutions.com>

For product information
<http://solutions.brother.com/>

Supplies / Accessories
1-800-543-6144

Brother Mobile Solutions, Inc., 100 Technology Drive, #250A, Broomfield, CO 80021

Contents

GETTING STARTED 21

Unpacking Your P-touch Labeling System 21

General Description 22

 LCD Display 23

 Key Names and Functions 25

Power Supply 27

 AC Adapter 27

 Rechargeable Li-ion Battery 27

 Alkaline/Ni-MH Battery 30

Inserting a Tape Cassette 31

Turning Power On/Off 32

 Auto Power-Off Time 32

Feeding Tape 33

 Feed & Cut 33

 Feed Only 33

LCD Display 34

 LCD Contrast 34

 Backlight 34

Setting Language and Unit 35

 Language 35

 Unit 35

EDITING A LABEL 36

Selecting a Labeling Application Type 36

 GENERAL 36

 FACEPLATE 36

 CABLE WRAP 36

 CABLE FLAG 37

 PATCH PANEL 37

 PUNCH-DOWN BLOCK 38

 Heat Shrink Tube 38

Creating a Bar Code Label 39

 Setting Bar Code Parameters and Entering Bar Code Data 39

 Editing and Deleting a Bar Code 40

Entering a Serialize Label 40

 Serialize 40

 Advanced Serialize 41

USING P-TOUCH SOFTWARE 44

Using P-touch Software 44

 Features 44

 System Requirements 44



 Installing the Software and Printer Driver 45

 Uninstalling the Printer Driver 47









 Uninstalling the Software 48

Safety Precautions

To prevent injury and damage, important notes are explained using various symbols. The symbols and their meanings are as follows:

 DANGER	Indicates an imminently hazardous situation which, if the product is handled without following the warnings and instructions, will result in death or serious injuries.
 WARNING	Indicates a potentially hazardous situation which, if not avoided, could result in death or serious injuries.
 CAUTION	Indicates a potentially hazardous situation which, if not avoided, may result in minor or moderate injuries.

The symbols used in this manual are as follows:

	Action NOT allowed		DO NOT disassemble the product.
	DO NOT splash the product with or immerse the product in water.		DO NOT touch a given portion of the product.
	Mandatory action		Unplugging is required
	Indicates risk of fire under certain circumstances.		Alerts to the possibility of electrical shock

⚠ DANGER

Rechargeable Li-ion Battery

Carefully observe the following precautions for the rechargeable Li-ion battery (hereafter referred to as "rechargeable battery"). If these precautions are not followed, overheating, leaking, or cracks in the battery may result in an electrical short, explosion, smoke, fire, electric shock, injury to yourself or others, or damage to the product or other property.

- ⊘ Use the rechargeable battery only for its intended purpose. The P-touch labeling system and rechargeable battery are designed to function exclusively with each other. DO NOT insert the rechargeable battery into a different P-touch labeling system, or a different rechargeable battery into your P-touch labeling system, otherwise fire or damage may result.
- ⊘ To charge the rechargeable battery, insert it into the P-touch labeling system, and then use the AC adapter designed specifically for this P-touch labeling system.
- ⊘ DO NOT charge the rechargeable battery near a fire or in direct sunlight. This could activate the protection circuitry, which is designed to prevent danger from high heat. Activation of the protection circuitry could cause charging to stop, charging to occur with excessive current/voltage if the protection circuitry fails, or an abnormal chemical reaction within the battery.
- ⊘ When charging the rechargeable battery, use only a battery charger designed specifically for the rechargeable battery.
- ⊘ DO NOT allow wires or other metal objects to come into contact with the terminals of the rechargeable battery. DO NOT carry or store the rechargeable battery with metal objects such as necklaces or hairpins. This could cause an electrical short, and lead metal objects such as wires, necklaces, or hairpins to overheat.
- ⊘ DO NOT use or leave the rechargeable battery near fire, heaters, or other high temperature (above 176°F/80°C) locations.
- ⊘ DO NOT allow the rechargeable battery to come into contact with or to be immersed in water.
- ⊘ DO NOT use the rechargeable battery in corrosive environments, such as areas where salty air, salt water, acids, alkalis, corrosive gases, chemicals, or any corrosive liquid are present.
- ⊘ DO NOT use the rechargeable battery if it is damaged or leaking.
- ⊘ DO NOT directly solder any connections to the rechargeable battery. This could cause internal insulation to melt, gas to be emitted, or safety mechanisms to fail.
- ⊘ DO NOT use the rechargeable battery with the polarity (+) (-) reversed. Check the orientation of the rechargeable battery before inserting it, and do not try to force the rechargeable battery into the P-touch labeling system. Charging the rechargeable battery with the polarity reversed could cause an abnormal chemical reaction within the rechargeable battery or abnormal current flow during discharge.
- ⊘ DO NOT directly connect the rechargeable battery to a household electrical supply.

⚠ DANGER

Rechargeable Li-ion Battery

- ⊘ Liquid (electrolyte) leaking from the P-touch labeling system or rechargeable battery may indicate that the rechargeable battery is damaged. If the rechargeable battery leaks, immediately stop using the P-touch labeling system, unplug the AC adapter, and isolate the P-touch labeling system by placing it in a bag.
- ⚠ Do not touch the electrolyte. If electrolyte gets in the eyes, do not rub them. Immediately rinse liberally with tap water or other clean water and seek the advice of a medical professional. If left alone, the electrolyte could cause eye damage. If electrolyte contacts your skin or clothing, immediately rinse them with water.
- ⊘ DO NOT put the rechargeable battery, or a P-touch labeling system with the rechargeable battery installed, into a microwave oven or a high pressure container.
- ⊘ DO NOT leave a drained rechargeable battery in the P-touch labeling system for a long period of time. This could shorten the life of the rechargeable battery or lead to an electrical short.
- ⚠ If the P-touch labeling system can only be used for a short period of time, even though the rechargeable battery is fully charged, the rechargeable battery may have reached the end of its service life. Replace the rechargeable battery with a new one. When removing and replacing the rechargeable battery, cover the terminals of the old rechargeable battery with tape to avoid creating a short in the battery.
- ⊘ DO NOT disassemble, modify, or attempt to repair the rechargeable battery.
- ⊘ DO NOT dispose of the rechargeable battery in fire or intentionally overheat. This could cause the internal insulation to melt, gas to be emitted, or safety mechanisms to fail. Additionally, the electrolyte solution could catch fire.
- ⊘ DO NOT puncture the rechargeable battery with any objects, subject it to severe shocks or throw it. Damage to the rechargeable battery's protection circuit could cause the rechargeable battery to be recharged at an abnormal current/voltage or cause an abnormal chemical reaction within the rechargeable battery.
- ⊘ DO NOT incinerate the rechargeable battery or dispose of it with household waste.

⚠ WARNING

P-touch Labeling System

Follow these guidelines to avoid fire, electric shock, the risk of injury to yourself or others, and/or damage to the P-touch labeling system or other property.

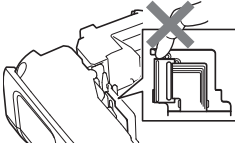







- ⊘ DO NOT allow the P-touch labeling system to get wet or use the P-touch labeling system in areas that may become wet, such as bathrooms or near sinks.
- ⊘ DO NOT touch any metal parts near the print head. The print head becomes very hot during use and remains very hot immediately after use. Do not touch it directly with your hands.
- ⊘ DO NOT use the P-touch labeling system with a foreign object in it. If water, a metallic substance, or any other foreign object enters the P-touch labeling system, disconnect the AC adapter and remove the batteries, and contact Brother customer service.
- ⊘ Do not use the P-touch labeling system in special environments, such as near medical equipment. Electromagnetic waves may cause the medical equipment to malfunction.
- ⚠ Users with heart pacemakers should move away from the P-touch labeling system if they sense any abnormalities. Then, immediately seek the advice of a medical professional.
- ⊘ DO NOT disassemble the P-touch labeling system. For inspection, adjustment, and repair of the P-touch labeling system, contact Brother customer service.
- ⊘ Plastic bags are used in the packaging of your P-touch labeling system. To avoid danger of suffocation, keep these bags away from babies and children.
- ⚠ If you notice heat, an abnormal odor, discoloration of the P-touch labeling system, deformation, or anything else unusual while using or storing the P-touch labeling system, immediately stop using the P-touch labeling system, disconnect the AC adapter, and remove the batteries.
- ⊘ To prevent damage, do not drop or hit the P-touch labeling system.

WARNING

Alkaline batteries/Ni-MH rechargeable batteries

Follow these guidelines to avoid liquid leakage, heat, rupture of the battery and cause personal injury.

-  DO NOT throw into fire, heat up, short-circuit, recharge, or disassemble the battery.
-  DO NOT allow batteries to get wet, for example, by handling them with wet hands or spilling beverages onto them.
-  If fluid leaked from the batteries gets into your eyes, immediately rinse your eyes with a large amount of clean water, and then seek medical attention. If leaked fluid enters your eyes, loss of eyesight or other damage to the eyes may result.
-  DO NOT allow a metal object to contact both the plus and minus ends of a battery.
-  DO NOT use sharp objects, such as tweezers or a metallic pen, to remove or replace the batteries.
-  DO NOT use a damaged, deformed, or leaking battery, or a battery whose label is damaged. Doing so may result in generating excessive heat. Use of a damaged or leaking battery may also lead to battery fluid getting on your hands. If leaked fluid gets onto your hands and you rub your eyes, loss of eyesight or other damage to the eyes may result. Immediately rinse your hands with a large amount of clean water, and then seek medical attention.

⚠ WARNING

AC Adapter

Follow these guidelines to avoid fire, damage, electric shock, failure or the risk of injury.

- ❗ Make sure that the plug is fully inserted into the power outlet. Do not use an outlet that is loose.
- ❗ Always use the specified AC adapter, and always plug the AC adapter into an electrical outlet with the specified voltage (120V). Failure to do so may result in injury to yourself or others, or damage to the P-touch labeling system or other property. Brother does not assume any responsibility for any accident or damage, resulting from not using the specified AC adapter and adapter cord.
- ⊘ DO NOT connect the AC adapter or adapter cord to other products.
- ⚠ DO NOT touch the AC adapter and the P-touch labeling system during a thunderstorm. There may be a remote risk of electric shock from lightning when the P-touch labeling system is used during a thunderstorm.
- ⊘ DO NOT touch the AC adapter or power plug with wet hands.
- ⊘ DO NOT use the AC adapter in places with high humidity or moisture, such as bathrooms.
- ⊘ DO NOT use a damaged adapter cord or power plug.
- ⊘ DO NOT place heavy objects on, damage, or modify the adapter cord or plug. Do not forcibly bend or pull the adapter cord.
- ⊘ DO NOT drop, hit, or otherwise damage the AC adapter.

Tape Cutter

- ⊘ DO NOT touch the blade of the cutter unit.

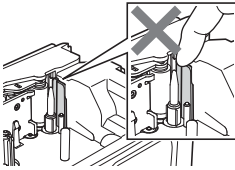

⚠ CAUTION

Alkaline batteries/Ni-MH rechargeable batteries

Follow these guidelines to avoid liquid leakage, overheating or rupture of the battery.

- ⊘ DO NOT use a battery other than the one specified for use with your P-touch labeling system. Do not use combinations of old and new batteries or combinations of different types, different charging levels, different manufacturers or different models. Do not insert a battery with the polarity (+ and -) reversed.
 - ⚠ If fluid leaked from the battery gets on your skin or clothes, immediately rinse them with clean water.
 - ⚠ Remove the batteries if you do not intend to use the P-touch labeling system for an extended period of time.
- ⚠ Before using Ni-MH rechargeable batteries, carefully read the instructions for the batteries and battery charger, and be sure to use them correctly.
 - ⚠ When using Ni-MH rechargeable batteries, charge the batteries before using them with the appropriate, specialised battery charger.
 - ⊘ DO NOT disassemble or modify the batteries.
 - ⊘ DO NOT expose the batteries to heat or dispose of the batteries in a fire.

AC Adapter

- ⚠ If you do not intend on using the P-touch labeling system for an extended period of time, disconnect the AC adapter from the power outlet.
 - ⚠ When disconnecting the AC adapter from the power outlet, always hold the AC adapter.
 - ⊘ DO NOT use the AC adapter in places of high humidity such as bathrooms.
- ⊘ DO NOT overload an electrical circuit with the AC adapter.
 - ⊘ DO NOT disassemble or modify the AC adapter.
 - ⊘ DO NOT allow the AC adapter/power plug to get wet, for example, by handling them with wet hands or spilling beverages on to them.

Tape Cutter









Follow these guidelines to avoid minor personal injury and damage to the P-touch labeling system.

- ⊘ DO NOT open the tape compartment cover when operating the cutter unit.
- ⊘ DO NOT apply excessive pressure to the cutter unit.

CAUTION

P-touch Labeling System

Follow these guidelines to avoid minor personal injury and damage to the P-touch labeling system.

-  Store the P-touch labeling system on a flat, stable surface such as a desk or in a drawer.
-  DO NOT leave the P-touch labeling system or any tape within the reach of young children.
-  DO NOT place any heavy objects on top of the P-touch labeling system.
-  Always use the suggested AC adapter (AD-E001) for the P-touch labeling system and plug it into an outlet with the specified voltage. Failure to do so could result in damage or failure of the P-touch labeling system.
-  DO NOT use the P-touch labeling system in places with moisture or high humidity, such as bathrooms.
-  DO NOT allow the P-touch labeling system to get wet, for example, by handling it with wet hands or spilling beverages onto it.
-  DO NOT disassemble or modify the P-touch labeling system.
-  If you notice heat, an abnormal odor, discoloration of the P-touch labeling system, deformation, or anything else unusual while using or storing the P-touch labeling system, immediately discontinue the use of the P-touch labeling system, disconnect the AC adapter, and remove the batteries.

General Precautions

Rechargeable Li-ion battery

- At the time of purchase, the rechargeable Li-ion battery is slightly charged so that the operation of the P-touch labeling system can be verified; however, the rechargeable Li-ion battery should be fully charged with the AC adapter before the P-touch labeling system is used.
- If the P-touch labeling system will not be used for a long period of time, remove the rechargeable Li-ion battery from the P-touch labeling system, and then store it in a location where it is not exposed to static electricity, high humidity, or high temperatures (temperatures between 59°F/15°C and 77°F/25°C 40% to 60% humidity are recommended). In order to maintain the efficiency and life of the Li-ion rechargeable battery, charge it at least every six months.
- If you notice anything unusual about the rechargeable Li-ion battery the first time it is used, for example overheating or rust, DO NOT continue to use the battery. Contact Brother customer service.

P-touch Labeling System

- DO NOT install the P-touch labeling system near any device that will cause electromagnetic interference. The P-touch labeling system may malfunction if left near a television, radio, microwave oven, etc.
- DO NOT use the P-touch labeling system in any way or for any purpose not described in this guide. Doing so may result in injury or damage to the P-touch labeling system.
- DO NOT put any foreign objects into the tape exit slot, AC adapter connector, or any other part of the P-touch labeling system.
- DO NOT touch the print head (see page 12) with your fingers. Use the optional print head cleaning cassette (TZe-CL4) or a soft wipe (e.g.a cotton swab) when cleaning the print head (see the User's Guide).
- DO NOT clean any part of the P-touch labeling system with alcohol or other organic solvents. Only use a soft, dry cloth.
- DO NOT place the P-touch labeling system in direct sunlight, near heaters or other hot appliances, or in any location exposed to extremely high or low temperatures, high humidity, or dust. The standard operating temperature range of the P-touch labeling system is 50°F/10°C to 95°F/35°C.
- DO NOT leave any rubber or vinyl, or products made of rubber or vinyl, on the P-touch labeling system for an extended period of time, otherwise the P-touch labeling system may become marked.
- Depending on the environmental conditions and the applied settings, some characters or symbols may be difficult to read.
- Use only Brother TZe, HGe tapes or HSe tubes with the P-touch labeling system. Do not use tapes that do not have the  mark.
- DO NOT pull or apply pressure to the tape in the cassette to avoid damaging the P-touch labeling system.
- DO NOT try to print labels using an empty tape cassette or without a tape cassette in the P-touch labeling system. Doing so will damage the print head.
- DO NOT attempt to cut the tape while printing or feeding since this will damage the tape.
- Depending on the location, material, and environmental conditions, the label may peel or become irremovable, and the color of the label may change or be transferred to other objects.

INTRODUCTION



- DO NOT expose the tape cassettes to direct sunlight, high temperatures, high humidity, or dust. Store tape cassettes in a cool, dark place. Use the tape cassettes soon after opening the tape cassette package.
- Markings made with oil-based or water-based ink may be visible through a label affixed over them. To hide the markings, use two labels layered on top of each other or use a dark-colored label.
- Any data stored in memory will be lost due to failure or repair of the P-touch labeling system, or if the battery expires.
- When power is disconnected for more than two minutes, all text and format settings will be cleared. Any text files stored in the memory will also be cleared.
- A protective clear plastic sticker is placed over the display during manufacturing and shipping. This sticker should be removed prior to use.
- The length of the printed label may differ from the displayed label length.
- You can also use Heat Shrink Tube in this model.
Check the Brother website (<http://www.brother.com/>) for further information. You cannot print frames, pre-set P-touch templates, or use certain font settings when using Heat Shrink Tube. Printed characters may also be smaller than when using TZe tape.
- The P-touch labeling system is not equipped with a charging feature for Ni-MH rechargeable batteries.
- The printed label may differ from the image that appears on the LCD.
- Note that Brother Industries, Ltd. does not assume responsibility for any damage or injury arising from the failure to follow the precautions listed in this manual.
- We strongly recommend that you read this User's Guide carefully before using your P-touch labeling system, and then keep it nearby for future reference.

CD-ROM

- DO NOT scratch the CD-ROM, expose it to extremely high or low temperatures, place heavy objects on top of it, or bend it.
- The software on the CD-ROM is intended for use with the P-touch labeling system, and may be installed on more than one computer.

Symbols Used in this Guide

The following symbols are used throughout this guide to indicate additional information.

-  : This symbol indicates information or directions that may result in damage or injury if ignored, or operations that will result in errors.
-  : This symbol indicates information or directions that may help you understand and use the P-touch labeling system more efficiently.

How to Use the P-touch Labeling System

■ Create a label with the P-touch labeling system

1 GETTING STARTED

- Preparing the P-touch labeling system. **P. 21**

2 CREATING A LABEL

- Selecting a labeling application type. **P. 36**
- Entering and editing text.
- Entering symbols.
- Entering accented characters.
- Setting cut options.

"Editing a Label" in the User's Guide



In addition to entering text, the P-touch labeling system has a large range of formatting options.

Create labels like these:

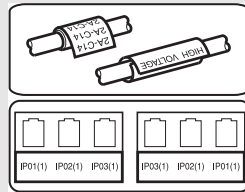

3 LABEL PRINTING

- Printing a label.

"Label Printing" in the User's Guide



Before printing, you can check the layout of your label using the preview function.

Create labels like these:

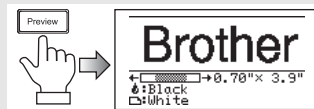

- ⓘ Remove the labels soon after they are cut so that they do not remain in the tape exit slot.
- Do not position the P-touch labeling system vertically when using it. Otherwise, the cut labels could fall into the machine and cause a malfunction.

INTRODUCTION

■ Create a label by connecting your P-touch labeling system to a computer

1 GETTING STARTED

Your P-touch labeling system can be used as a stand alone handheld labeler, or it can be connected to a PC or Mac and used with the included P-touch Editor software to create more elaborate labels.

To use your P-touch labeling system connected to a computer, attach your P-touch labeling system to a computer via the included USB cable and install the P-touch Editor software and drivers.

- Prepare the P-touch labeling system.
- Prepare the PC.

P. 44

2 CREATING A LABEL

- Launch the P-touch Editor Software.
Enter the label text using P-touch Editor.

"Editing a Label" in the User's Guide

Software Help



Create labels like these:



1A-B01
1A-B01
1A-B01
1A-B01

1A-B01 | 1A-B02 | 1A-B03 | 1A-B04

3 LABEL PRINTING

- Print the label

"Label Printing" in the User's Guide

Software Help







- Remove the labels soon after they are cut so that they do not remain in the tape exit slot.
- Do not position the P-touch labeling system vertically when using it. Otherwise, the cut labels could fall into the P-touch labeling system and cause a malfunction.

GETTING STARTED

Unpacking Your P-touch Labeling System

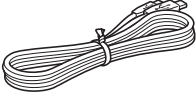
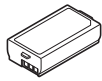
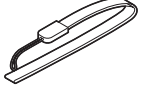
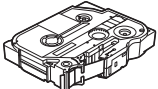
Check that the package contains the following before using your P-touch labeling system:

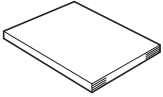
■ PT-E550W		
P-touch labeling system 	AC adapter  The plug may differ by country.	USB cable 
	Li-ion Battery 	Strap 
Tape Cassette 	CD-ROM 	Quick Setup Guide 

General Description

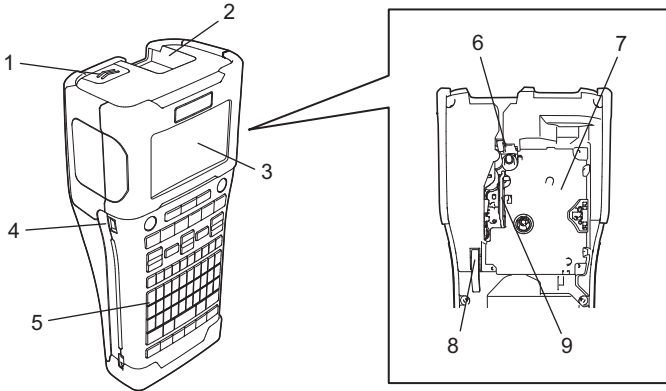

- 1. Cover latch
- 2. Tape exit slot
- 3. LCD display
- 4. Mini-USB port
- 5. Keyboard

- 6. Tape cutter
- 7. Tape cassette compartment
- 8. Release lever
- 9. Print head

 When shipped from the factory, the LCD display is covered with a protective sheet to prevent damage. Remove this sheet before using the P-touch labeling system.

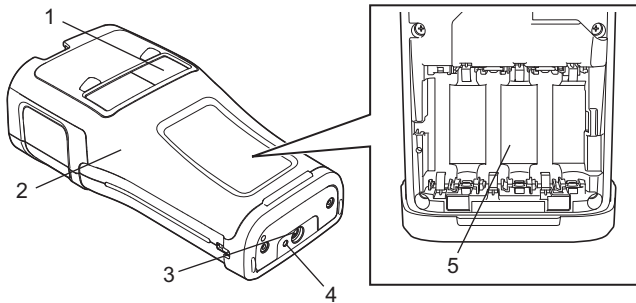

- 1. Tape viewer
- 2. Rear cover
- 3. AC adapter connector

- 4. LED lamp
- 5. Battery compartment



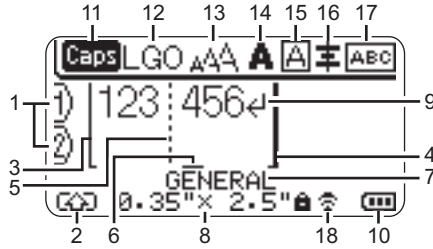

LCD Display



- 1. Line number**
Indicates line number within the label layout.
- 2. Shift Mode**
Indicates shift mode is on.
- 3. Start Line / 4. End Line**
The area between the start and end line will be printed.
The short lines extending from the start/end lines show the end of the label layout.
- 5. Block Separator Line**
Indicates the end of a block.
- 6. Cursor**
Indicates the current data input position. Characters are entered to the left of the cursor.
- 7. Labeling Application Type**
Indicates current labeling application type.
- 8. Tape size**
Indicates the tape size as follows for the text entered:
Tape width x Label length
If the label length has been specified, , also appears on the right side of the tape size.
- 9. Enter/Return symbol**
Indicates the end of a line of text.
- 10. Battery Level**
Indicates remaining battery level. It displays only when using Li-ion battery.

-  -Full
-  -Low
-  -Half
-  -Empty

- 11. Caps mode**
Indicates that the Caps mode is on.
- 12.-16. Style guidance**
Indicates the current font (12), character size (13), character style (14), frame (15) and alignment (16) settings.
The alignment guidance may not be displayed depending on the selected labeling application type.
- 17. Layout guidance**
Indicates the orientation, layout, separator, reverse, and repeated text settings. The displayed items vary according to the selected labeling application type.
- 18. Wireless connection**
Indicates the current state of the wireless connection.

	Connected in WLAN mode
	Disconnected in WLAN mode
	Connected/Disconnected in Direct mode
	Establishing connection by setup wizard
(blinking)	Establishing connection by Ad-hoc mode
(off)	Wireless connection OFF

GETTING STARTED

.....

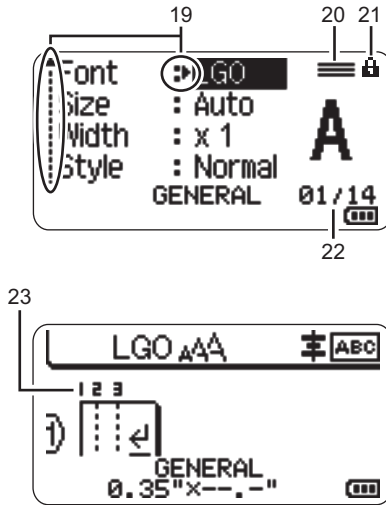

19. Cursor selection

Use the ▲ and ▼ keys to select menu items and the ◀ and ▶ keys to change the settings.

20. Specified line mark

Indicates that separate settings are made for each line.

21. Lock mark

Indicates that some items cannot be changed.

22. Counter

Indicates currently selected number/ selectable number.

23. Block Number

Indicates the block number.

ⓘ Refer to "LCD Display" on page 34 for details on changing the contrast and backlight settings of the LCD.

Key Names and Functions

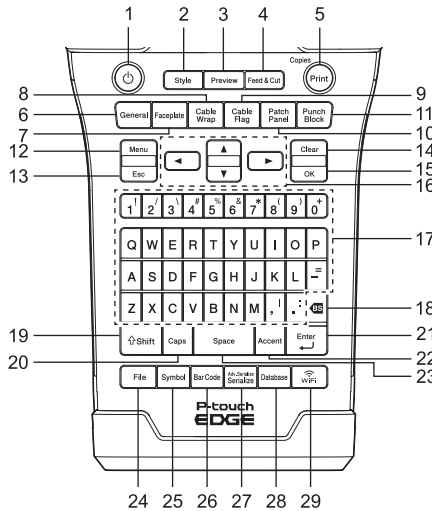

The default language is "English".

- 1. Power**
Turns the P-touch labeling system on and off.
- 2. Style**
Sets character and label attributes.
- 3. Preview**
Displays a preview of the label.
- 4. Feed & Cut**
Feeds 0.96" (24.5mm) of blank tape then cuts the tape.
- 5. Print**
 - Prints the current label design onto the tape.
 - Prints multiple copies with the **Shift** key.
- 6. General**
Creates general purpose labels.
- 7. Faceplate**
Creates labels for faceplates, nameplates and single port applications.
- 8. Cable Wrap**
Creates labels that wrap around a cable, fiber or wire.
- 9. Cable Flag**
Creates cable flag labels.
- 10. Patch Panel**
Creates single and multiple line labels for a group of ports on a patch panel.
- 11. Punch Block**
Creates labels up to 3 lines for punch-down blocks.
- 12. Menu**
Sets the P-touch labeling system operating preferences (Language, Adjustment, etc.).
- 13. Esc (Escape)**
Cancels the current command and returns the display to the data entry screen or the previous step.
- 14. Clear**
Clears all text entered, or all text and current label settings.
- 15. OK**
Selects the displayed option.
- 16. Cursor (▲▼◀▶)**
Moves the cursor in the direction of the arrow.

GETTING STARTED

17. Letter

- Use these keys to type letters or numbers.
- Uppercase letters and symbols can be entered using these keys in combination with the **Caps** or **Shift** key.

18. BS (backspace)

Deletes the character to the left of the cursor.

19. Shift

Use this key in combination with the letter and number keys to type uppercase letters or the symbols indicated on the number keys.

20. Caps

Turns Caps mode on and off.

21. Enter

- Enters a new line when entering text.
- For only the "GENERAL" label application type, enters a new block when used in combination with the **Shift** key.

22. Accent

Use this to select and enter an accented character.

23. Space

- Enters a blank space.
- Returns a setting to the default value.

24. File

Enables frequently used labels in the file memory to be printed, opened, saved, or deleted.

25. Symbol

Use this to select and enter a symbol from a list of available symbols.

26. Bar Code

Opens Bar Code Setup screen.

27. Serialize

- Prints serialized labels.
- Serializes and prints any 2 numbers on a label simultaneously when used in combination with the **Shift** key.

28. Database

Uses the selected range of records in the downloaded database to create a label.

29. WiFi

Starts WLAN/ Wireless Direct communication.

Power Supply

AC Adapter

Use the AD-E001 (AC adapter) for this P-touch labeling system. Connect the AC adapter directly to the P-touch labeling system.

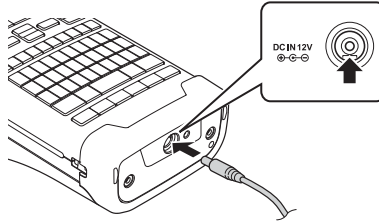

! The AD-18 or AD-24ES cannot be used.

1 Insert the plug on the AC adapter cord into the connector marked DC IN 12V on the P-touch labeling system.

2 Insert the AC adapter plug into a standard electrical outlet.

- !
- Turn the P-touch labeling system off before disconnecting the AC adapter.
 - Do not pull or bend the AC adapter cord.
 - When disconnected from the power and battery for more than two minutes, all text and format settings will be cleared.
 - Downloaded symbols, templates and databases will be saved, even with no power available.
 - After the AC adapter plug is inserted into the electrical outlet, it may take a few seconds until the  (Power) button is enabled.

💡 To safeguard and backup the P-touch labeling system's memory, when the AC adapter is unplugged it is recommended to have rechargeable Li-ion batteries (BA-E001), AA-size alkaline batteries (LR6) or Ni-MH rechargeable batteries (HR6) installed in the P-touch labeling system.

Rechargeable Li-ion Battery

■ Installing the Rechargeable Li-ion Battery

- 1** Open the rear cover by pressing the cover latch.
1. Rear cover
 2. Cover latch

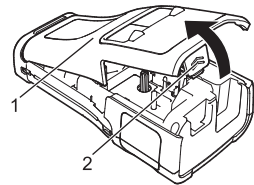

GETTING STARTED

- 2 Insert the rechargeable Li-ion battery into the battery compartment.

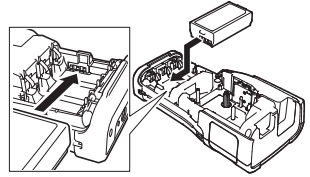

- 3 Confirm that the hooks on the edge of the rear cover are inserted correctly, and then reattach the cover.

! If you cannot attach the rear cover, check to ensure the white lever is in the up position. If not, lift the lever, and then attach the cover.

■ Removing the Rechargeable Li-ion Battery

Remove the battery cover and the rechargeable Li-ion battery, and then reattach the battery cover.

■ Charging the Rechargeable Li-ion Battery

The rechargeable Li-ion battery can be charged while it is inserted in the P-touch labeling system. Perform the following procedure to charge the rechargeable Li-ion battery.

- Before using the rechargeable Li-ion battery, use the following procedure to charge it.
- Up to 6 hours may be needed to fully charge the rechargeable Li-ion battery.

- 1 Make sure that the P-touch labeling system is turned off. If the P-touch labeling system is turned on, press and hold the  (Power) button to turn it off.

- 2 Make sure that the rechargeable Li-ion battery is installed in the P-touch labeling system.

- 3 Use the AC adapter to connect the P-touch labeling system to an AC power outlet.

The LED next to the adapter connector turns on during charging, it goes off when the rechargeable Li-ion battery is fully charged. The battery level indicator on the display will fill three bars .

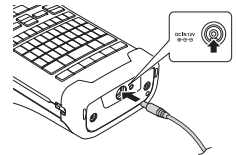

■ Stopping Rechargeable Li-ion Battery Charging

To stop the rechargeable Li-ion battery from charging, disconnect the AC adapter.

**Tips on Using the Rechargeable Li-ion Battery**

- Charge the rechargeable Li-ion battery before use. Do not use it before it is charged.
- The rechargeable Li-ion battery charging can take place in 41°F/5°C to 95°F/35°C environments. Charge the rechargeable Li-ion battery in an environment in this temperature range. If the surrounding temperature is out of this range, the rechargeable Li-ion battery will not be charged, and the battery indicator will remain lit.
- If the P-touch labeling system is used when both the rechargeable Li-ion battery is installed and the AC adapter is connected, the battery indicator may turn off and charging may stop even if the rechargeable Li-ion battery has not been fully charged.

**Rechargeable Li-ion Battery Characteristics**

Understanding the properties of the rechargeable Li-ion battery will allow you to optimize its usage.

- Using or storing the rechargeable Li-ion battery in a location exposed to high or low temperatures may accelerate its deterioration. In particular, using a rechargeable Li-ion battery with a high charge (90% or more) in a location exposed to high temperatures will considerably accelerate battery deterioration.
- Using the P-touch labeling system while the rechargeable Li-ion battery is installed and charging may accelerate the battery's deterioration. If using the P-touch labeling system when the rechargeable Li-ion battery is installed, disconnect the AC adapter.
- If the P-touch labeling system will not be used for longer than one month, remove the rechargeable Li-ion battery from the P-touch labeling system, and then store the battery in a cool place away from direct sunlight.
- If the rechargeable Li-ion battery will not be used for a long period of time, we recommend charging it every 6 months.
- If you touch a part of the P-touch labeling system while the Li-ion battery is charging, that part of the P-touch labeling system may feel warm. This is normal, and the P-touch labeling system may be used safely. If the P-touch labeling system becomes extremely hot, discontinue use.

Specifications

- Charging time: Approximately 6 hours when charged by an AC adapter (AD-E001).
- Nominal Voltage: DC 7.2 V
- Nominal Capacity: 1850 mAh

Rechargeable Li-ion Battery**Surroundings temperature range**

Charge		104°F/40°C
Standard discharge current 1.9 A		140°F/60°C
Maximum discharge current 2.5 A		140°F/60°C
Supplied battery	Less than 1 month	-4°F - 122°F/-20°C - 50°C
	Less than 3 month	-4°F - 104°F/-20°C - 40°C
	Less than 1 year	-4°F - 68°F/-20°C - 20°C

Charging Parameters

Maximum charging voltage	8.2 Vdc
Maximum charging current	1330 mA

GETTING STARTED

P-touch Labeling System

- Charging current: 800 mA
- Charging voltage: up to 8.2 V (Maximum)

Alkaline/Ni-MH Battery

- 1** After making sure that the power is off, remove the rear cover on the back of the P-touch labeling system. If the batteries are already in the P-touch labeling system, remove them.

- ! Make sure that the power is turned off when replacing batteries.

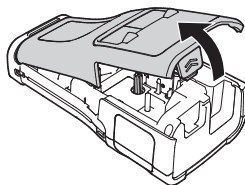

- 2** Insert six new AA-size alkaline batteries (LR6), or fully charged Ni-MH rechargeable batteries (HR6). Make sure that the positive (+) and negative (-) ends of the batteries match the positive (+) and negative (-) marks inside the battery compartment.

Users of alkaline batteries

- ! Always replace all six batteries at the same time using brand new ones.

Users of Ni-MH rechargeable batteries

- ! Always replace all six batteries at the same time with fully charged ones.

- 💡 Visit us at <http://solutions.brother.com/> for the latest information about recommended batteries.

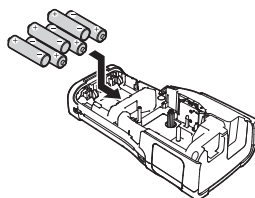

- 3** Attach the rear cover by inserting the three hooks at the bottom into the slots on the P-touch labeling system, then pushing down firmly until it snaps into place.

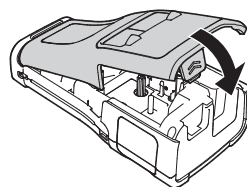

- ! • Remove the batteries if you do not intend to use the P-touch labeling system for an extended period of time.
- Dispose of the battery at an appropriate collection point, not in the general waste stream. In addition, be sure to observe all applicable regulations.
 - When storing or discarding the battery, wrap it (for example with cellophane tape), to prevent it from short-circuiting.

(Battery insulation example)

1. Cellophane tape
2. Alkaline or Ni-MH battery

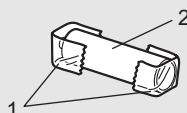

Inserting a Tape Cassette

Tape cassettes of 0.13", 0.23", 0.35", 0.47", 0.70" or 0.94" (3.5mm, 6mm, 9mm, 12mm, 18mm or 24mm) width, and Tube cassettes of 0.23", 0.34", 0.46", 0.69" or 0.93" (5.8mm, 8.8mm, 11.7mm, 17.7mm or 23.6mm) width can be used in your P-touch labeling system. Use only Brother tape cassettes with the **TZ** / **HG** / **HS** mark.

- ❗ If the new tape cassette has a cardboard stopper, be sure to remove the stopper before inserting the cassette.

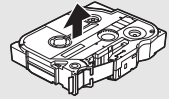

- 1** Check that the end of the tape is not bent and that it passes through the tape guide. If the tape is not passed through, pass it through the tape guide as shown in the illustration.

1. End of tape
2. Tape guide

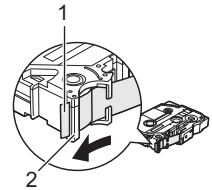

- 2** After making sure that the power is off, place the P-touch labeling system on a flat surface as shown in the illustration, and then open the rear cover. If there is already a tape cassette in the P-touch labeling system, remove it by pulling it straight up.

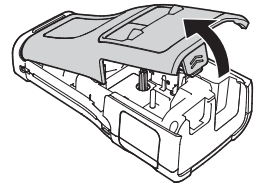

- 3** Insert the tape cassette into the tape compartment, with the end of the tape facing the P-touch labeling system's tape exit slot, and press firmly until you hear a click.

1. Tape exit slot

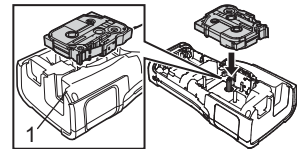

- ❗
- When inserting the tape cassette, make sure that the tape and ink ribbon do not catch on the print head.
 - Make sure that there is no slack in the tape, and then carefully insert the tape cassette. If there is slack in the tape, the tape will catch on the protrusion (2) when the cassette is inserted and become bent or wrinkled, causing the tape to jam.

To fix the slack in the tape, refer to the illustration in step 1 and pull the tape outside of the tape guide.

- When removing the tape cassette, make sure that the tape does not catch on the protrusion (2).

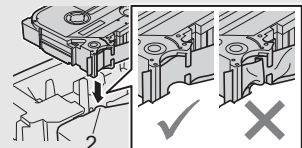

GETTING STARTED

4 Close the rear cover.

- ! Place the P-touch labeling system on a flat surface as shown in the illustration, and then attach the rear cover.
- If you cannot attach the rear cover, check to ensure the white lever (1) is in the up position. If not, lift the lever, and then attach the cover.

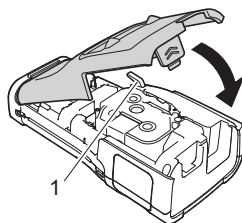



- ! **Do not pull the label coming out of the tape exit slot. Doing so will cause the ink ribbon to be discharged with the tape. The tape may no longer be functional after the ink ribbon discharges.**
- Store tape cassettes in a cool dark location, away from direct sunlight and high temperature, high humidity, or dusty locations. Use the tape cassette as quickly as possible after opening the sealed package.

Extra Strength Adhesive Tape:

- For rough and textured surfaces, we recommend using Extra Strength Adhesive Tape.
- Although the instruction sheet included with the Extra Strength Adhesive Tape cassette recommends cutting the tape with scissors, the tape cutter that this P-touch labeling system is equipped with is able to cut Extra Strength Adhesive Tape.**

Turning Power On/Off

Press the  (Power) button to turn the P-touch labeling system on.







Press and hold the  (Power) button again to turn the P-touch labeling system off.

- 💡 Your P-touch labeling system has a power saving function that automatically turns itself off if no key is pressed within a certain time, under certain operating conditions. Refer to the "Auto Power-Off Time" for details.

Auto Power-Off Time

If you use the AC adapter or Li-ion battery, you can change the setting of the auto power-off time.

- ! When you use alkaline batteries or Ni-MH batteries, the auto power-off time cannot be changed. (The time is fixed to 20 minutes.)

- 1 Press the **Menu** key, select "Auto Power Off" using the  or  key, and then press the **OK** or **Enter** key.
- 2 Select the battery shown on the LCD display by using the  or  key and set the value using the  or  key. "AC Adapter" or "Li-ion Battery" can be selected.
- 3 Press the **OK** or **Enter** key.

● Auto Power-Off Time ●

Setting	Value	Setting	Value
AC Adapter	Off	Li-ion Battery	Off
	10min.		10min.
	20min.		20min.
	30min.		30min.
	40min.		40min.
	50min.		50min.
	1hr.		1hr.
	2hr.		
	4hr.		
	8hr.		
	12hr.		

- ! If you connect the AC adapter to the P-touch labeling system after you specified "Auto Power Off", the setting for "AC Adapter" becomes valid.
- The default value is "1hr." for the AC Adapter and "30min." for the Li-ion battery.

Feeding Tape

- ! Be sure to feed tape to remove any slack in the tape and ink ribbon after inserting the tape cassette.
- Do not pull the label coming out of the tape exit slot. Doing so will cause the ink ribbon to be discharged with the tape. The tape may no longer be functional after the ink ribbon discharges.**
- Do not block the tape exit slot during printing or when feeding tape. Doing so will cause the tape to jam.

Feed & Cut

The Feed & Cut function feeds 0.96" (24.5mm) of blank tape, and then cuts the tape.

- 1 Press the **Feed & Cut** key.
"Feed & Cut?" will appear on the LCD display.
- 2 Using the ▲ or ▼ key to select the "Feed & Cut" and then press either **OK** or **Enter**.
The message "Feeding Tape... Please Wait" appears while the tape is fed, and then the tape is cut.



To exit or cancel this function press **Esc**.

Feed Only

This function will advance the tape approximately 0.96" (24.5mm), resulting in a blank label sticking out of the tape cassette. This action is recommended when using Fabric tapes, which should be cut using scissors.

GETTING STARTED

- 1] Press the **Feed & Cut** key.
"Feed & Cut?" will appear on the LCD display.
- 2] Using the **▲** or **▼** key to select the "Feed Only", and then press either **OK** or **Enter** key.
The message "Feeding Tape... Please Wait" appears while the tape is fed.



To exit or cancel this function press **Esc**.

LCD Display

LCD Contrast

You can change the contrast setting of the LCD display to one of five levels (+2, +1, 0, -1, -2) to make the screen easier to read. The default setting is "0".

- 1] Press the **Menu** key, select "Adjustment" using the **▲** or **▼** key, and then press the **OK** or **Enter** key.
- 2] Select "LCD Contrast" using the **▲** or **▼** key, and then set the value using the **◀** or **▶** key.
- 3] Press the **OK** or **Enter** key.



- Press the **Esc** key to return to the previous step.
- Pressing the **Space** key on the contrast setting screen sets the contrast to the default value "0".

Backlight

You can change the backlight setting either to on or off.
The display is easier to see with the backlight on. The default setting is on.

- 1] Press the **Menu** key, and then select "Advanced" using the **▲** or **▼** key. Press **OK** or **Enter** key.
- 2] Select "Backlight" using the **▲** or **▼** key, and press the **OK** or **Enter** key.
- 3] Select "On" or "Off" using the **▲** or **▼** key, and press the **OK** or **Enter** key.



- Power can be saved when the backlight is turned off.
- The backlight will automatically turn off, press any key to re-enable it. During printing, the backlight is disabled. The backlight turns on during data transmissions.

Setting Language and Unit

Language

- 1 Press the **Menu** key, select "□ Language" using the ▲ or ▼ key, and then press the **OK** or **Enter** key.
- 2 Select a language for menu commands and messages shown on the LCD display by using the ▲ or ▼ key.
The language can be selected from "Čeština", "Dansk", "Deutsch", "English", "Español", "Français", "Hrvatski", "Italiano", "Magyar", "Nederlands", "Norsk", "Polski", "Português", "Português (Brasil)", "Română", "Slovenski", "Slovenský", "Suomi", "Svenska" or "Türkçe".
- 3 Press the **OK** or **Enter** key.



Press the **Esc** key to return to the previous step.

Unit

- 1 Press the **Menu** key, select "Unit" using the ▲ or ▼ key, and then press the **OK** or **Enter** key.
- 2 Select a unit for dimensions shown on the LCD display by using the ▲ or ▼ key.
Either "inch" or "mm" can be selected.
- 3 Press the **OK** or **Enter** key.



The default setting is "inch".
Press the **Esc** key to return to the previous step.

EDITING A LABEL



Selecting a Labeling Application Type

You can select six different types of labeling applications.



GENERAL

Labels printed with this mode can be used for general purposes. In this mode you can specify the following items.

- Label Length: **Auto**, 0.4" (10 mm) - 39.0" (999 mm)
- Orientation:  (**Horizontal**),  (Vertical)

Horizontal

ABCDE



Vertical

⏏⏏⏏⏏

💡 When the GENERAL mode is selected, you can press the **Shift** key and then press the **Enter** key to add a new block.

FACEPLATE

Labels printed with this mode can be used to identify various faceplates. Block of text is evenly spaced on a single label. In this mode, and you can specify the following items.

- Label Length: **2.0" (50 mm)**, 0.4" (10 mm) - 39.0" (999 mm)
- # of Blocks: **1**, 1 - 5
- Orientation:  (**Horizontal**),  (Vertical)

1 block

1A-B01

2 blocks

1A-B01 1A-B02

CABLE WRAP

Labels printed with this mode can be wrapped around a cable or wire. In the CABLE WRAP mode, the text is rotated 90° counterclockwise and printed, you can also specify the following items.

- UOM: **Dia(Ø) (Custom Diameter)**, Length (Custom Length), CAT5/6, CAT6A, COAX, AWG
- Value: Depending on UOM
- Repeat: **On**, Off

2A-C14
2A-C14
2A-C14
2A-C14
2A-C14
2A-C14

Text: Type in single or multiple lines of data

💡 When using Flexible ID Tape:

- We recommend using Flexible ID Tape for Cable Wrap and Cable Flag labels.
- Labels made with Flexible ID Tape are not designed for use as electrical insulation.
- When wrapping labels around cylindrical objects, the diameter (1) of the object should be at least 0.12" (3 mm).
- The overlapping (2) ends of the label or the label flag should be at least 0.2" (5 mm).

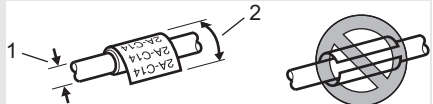

CABLE FLAG

Labels printed with this mode can be wrapped around a cable or wire, and both ends of the label stick together to form a flag. The text on flag labels is printed on both ends of the label, leaving a blank space in the middle that wraps around the cable. In this mode, you can specify the following items.

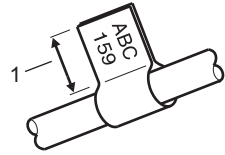

1. Flag at least 0.2" (5 mm)

- Layout: **AA : AA** (The same text is printed on each block.), **AA : BB** (Two different texts are printed on each block.)
- Flag Length: **1.2" (30 mm)**, 0.4" (10 mm) - 8.0" (200 mm)
- Cable Diameter: **0.25" (6 mm)**, 0.12" (3 mm) - 3.50" (90 mm)
- Orientation: **AB : AB** (Horizontal), **AB : BA** (Vertical)

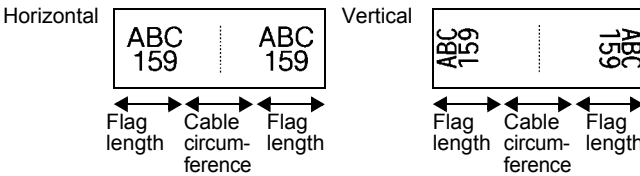

- You can enter up to two bar codes when **AA : AA** is selected in flag layout.
- We recommend using Flexible ID Tape for Cable Flag labels.
- Labels made with Flexible ID Tape are not designed for use as electrical insulation.

PATCH PANEL

Labels printed with this mode can be used to identify various types of panels. In this mode, you can specify the following items.

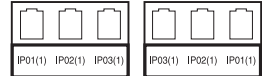

- Block Length: **0.60" (15.0 mm)**, 0.20" (5.0 mm) - 12.00" (300.0 mm)
- # of Blocks: **4**, 1 - 99
- Separator: **----** (Tic), **- - - -** (Dash), **| | | |** (Line), **▬▬▬▬** (Bold), **▭▭▭▭** (Frame), **.....** (None)
- Orientation: **1 2 3 4** (Horizontal), **1 2 3 4** (Vertical)
- Reverse: **Off**, On
- Advanced: **Off**, On
Adjust block length independently when "Advanced" is set to "On".

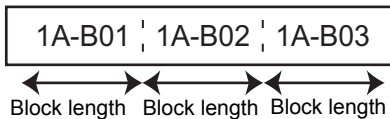

- No Margins: **Off**, On
Set the left and right label margins to zero.

- "Advanced" and "No Margins" cannot be set to "On" at the same time.

EDITING A LABEL

PUNCH-DOWN BLOCK

Labels printed with this mode can be used to identify a type of electrical connection often used in telephony. There are up to three lines for each block on a single label and you can enter three lines for each block. In this mode, you can specify the following items.

- Module Width: **8.0" (200 mm)**, 2.0" (50 mm) - 12.0" (300 mm)
- Block Type: **4 Pairs**, 2 Pairs, 3 Pairs, 5 Pairs, Blank
- Sequence Type: 123 (**None**), 123 (Horizontal), 123 (Backbone)
- Start Value: ---, 1 - 99999

B01	B02	B03	B04	B05	B06
B07	B08	B09	B10	B11	B12

1	4	8	12	16	20	24
25	28	32	36	40	44	48



- When "Blank" is selected in "Block Type", "Sequence Type" is set to None.
- When None is selected in "Sequence Type", "Start Value" shows "---" and you cannot set a value. Selecting Horizontal or Backbone however, allows you to set the "Start Value" from 1 to 99999.

Heat Shrink Tube

When using Heat Shrink Tube, the HEAT-SHRINK TUBE setting screen will be displayed when any of the labeling application type keys is pressed.

- Label length: **Auto**, 1.0" (25 mm) - 39.0" (999 mm)
However, the maximum printing length is 19.6" (500 mm) when using Heat Shrink Tube with a width of 0.23" (5.8 mm) or 0.34" (8.8 mm).

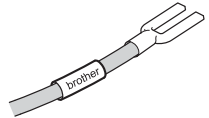

Text: Type in single or multiple lines of data



When using Heat Shrink Tube:

- You cannot print frames.
- Portions of some decorative characters may be cut off when a line is broken.
- The printed characters may be smaller than when using TZe tape.

Creating a Bar Code Label

Using the Bar Code function you can create labels with one dimensional bar codes for use with asset control tags, serial number labels, and even POS and stock control systems. Selectable "Bar Codes" are listed in the User's Guide.

- The P-touch labeling system is not designed exclusively for creating bar code labels. Always check that bar code labels can be read by the bar code reader.
- For best results, print bar code labels in black ink on white tape. Some bar code readers may not be able to read bar code labels created using colored tape or ink.
- Use the "Large" setting for "Width" whenever possible. Some bar code readers may not be able to read bar code labels created using the "Small" setting.
- Continuously printing a large number of labels with bar codes can overheat the print head, which may affect printing quality.

Setting Bar Code Parameters and Entering Bar Code Data

- 1 Press the **Bar Code** key.
The Bar Code Setup screen is displayed.

Up to five bar codes can be entered on a label.

- 2 Select an attribute using the ▲ or ▼ key, and then set a value for that attribute using the ◀ or ▶ key.
 - Protocol: **CODE39**, CODE128, EAN-8, EAN-13, GS1-128 (UCC/EAN-128), UPC-A, UPC-E, I-2/5 (ITF), CODABAR
 - Width: **Small**, Large
 - Under#: **On**, Off
 - C.Digit: **Off**, On
 Check digit only available for Code39, I-2/5 and Codabar protocols.

Characters may not appear below the bar code even when "On" is selected for "Under#", depending on the tape width being used, the number of lines entered, or the current character style settings.

- 3 Press the **OK** or **Enter** key to apply the settings.

New settings are NOT applied if you do not press the **OK** or **Enter** key.

- 4 Type in the bar code data.
Special characters can be entered in the bar code when using the CODE39, CODE128, CODABAR or GS1-128 protocols. When not using special characters, go to step 7.

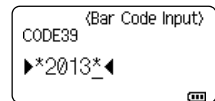

- 5 Press the **Symbol** key.
A list of characters available for the current protocol is displayed.

- 6 Select a character using the ▲ or ▼ key, then press the **OK** or **Enter** key to insert the character in the bar code data.

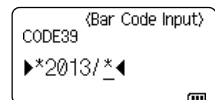

EDITING A LABEL

- 7] Press the **OK** or **Enter** key to insert the bar code in the label. The bar code is displayed on the text entry screen.



To print labels refer to the User's Guide.

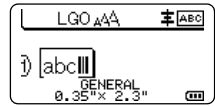

- Press the **Esc** key to return to the previous step.
- Press the **Space** key to set the selected attribute to the default value.

Editing and Deleting a Bar Code

- To edit bar code parameters and bar code data, position the cursor beneath the bar code mark on the data entry screen and then open the Bar Code Setup screen. Refer to "Setting Bar Code Parameters and Entering Bar Code Data" on page 39.
- To delete a bar code from a label, position the cursor to the right of the bar code mark on the data entry screen and press the **BS (backspace)** key.

Entering a Serialize Label

Numerically serialized labels can be created. You can set the increment and count for the series. In serialize mode, you can create a series of labels by incrementing one numeric character in the pattern. In advanced serialize mode, you can choose simultaneous or advanced. Simultaneous mode creates a series of labels by incrementing two different numbers at the same time. Advanced mode creates a series of labels by allowing you to select two sequences in the pattern and increment them consecutively.

Serialize

- 1] Enter text.

Example: Create labels 1A-A01, 1A-A02, 1A-A03, 1A-A04 from 1A-A01 by using this function.

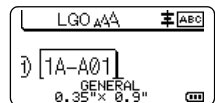

- 2] Press the **Serialize** key and the screen to specify the range is displayed.

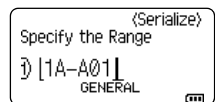

- 3] Use the **▲**, **▼**, **◀** or **▶** keys to position the cursor under the first character, and then press **OK** or **Enter** key. Then position the cursor under the last character to be incremented. Press **OK** or **Enter** key.

Example: Select 1 of A01.

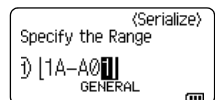

- 4] Select "Count" and "Incremented by" by using the **▲** or **▼** key and set the value by using the **◀** or **▶** key.

Example: When you want to increase the number by one four times, set "Count": 4, "Incremented by": 1.

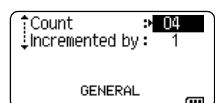

5 Press the **OK** or **Enter** key to display the screen that you set.

Example: 1A-A01 1A-A02 1A-A03 1A-A04

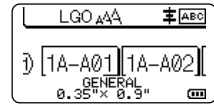

- When you press the **Serialize** key, you can do the setting again. After redoing the setting, the message "OK to Overwrite the Data after This Position?" is shown. If it's ok to overwrite, press **OK** key.
- You can select All/Current/Range when printing as there are multiple pages of labels.
- To print labels refer to the User's Guide.

Advanced Serialize

■ Simultaneous

1 Enter text.

Example: Create labels 1A-A01, 1A-B02, 1A-C03, 1A-D04 from 1A-A01 by using this function.

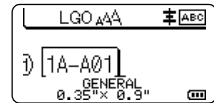

2 Press the **Shift** and **Serialize** keys and select "Simultaneous" by using the **▲** or **▼** key and press the **OK** or **Enter** key.

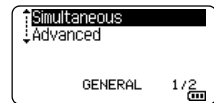

3 Specify the first range of characters that you want to increase.

- To specify one character, use the **▲**, **▼**, **◀** or **▶** key to position the cursor under the character and press the **OK** or **Enter** key twice.
- To specify a range of characters, use the **▲**, **▼**, **◀** or **▶** key to position the cursor under the first character in the range and press the **OK** or **Enter** key. Then, position the cursor under the last character in the range and press the **OK** or **Enter** key.

Example: Select 1 of A01.

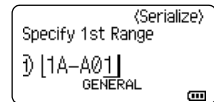

4 Repeat step 3 to specify the second range of characters that you want to increase.

Example: Select A of A01.



You cannot select the first character(s) because it is grayed out.

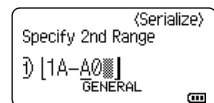

5 Select "Count" and "Incremented by" by using the **▲** or **▼** key and set the value by using the **◀** or **▶** key.

Example: When you want to increase the number by one four times, set "Count": 4, "Incremented by": 1.



EDITING A LABEL

6 Press the **OK** or **Enter** key to display the screen that you set.

Example:

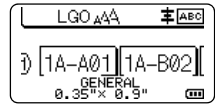

- When you press the **Shift** and **Serialize** keys, you can do the setting again. After redoing the setting, the message "OK to Overwrite the Data after This Position?" is shown. If it's ok to overwrite, press **OK** key.
- You can select All/Current/Range when printing as there are multiple pages of labels.
- To print labels refer to the User's Guide.

■ Advanced

1 Enter text.

Example: Create labels 1A-A01, 1A-A02, 1A-A03, 1A-A04 and 1A-B01, 1A-B02, 1A-B03, 1A-B04 from 1A-A01 by using this function.

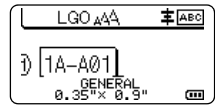

2 Press the **Shift** and **Serialize** keys and select "Advanced" by using the **▲** or **▼** key and press the **OK** key.

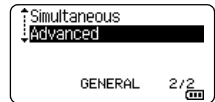

3 Specify the first range of characters that you want to increase.

- To specify one character, use the **▲**, **▼**, **◀** or **▶** key to position the cursor under the character and press the **OK** or **Enter** key twice.
- To specify a range of characters, use the **▲**, **▼**, **◀** or **▶** key to position the cursor under the first character in the range and press the **OK** or **Enter** key. Then, position the cursor under the last character in the range and press the **OK** or **Enter** key.

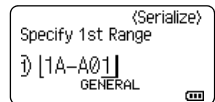

Example: Select 1 of A01.

4 Select "Count" and "Incremented by" by using the **▲** or **▼** key and set the value by using the **◀** or **▶** key.

Example: When you want to increase the number by one four times, set "Count": 04, "Incremented by": 1.

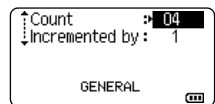

5 Repeat steps 3 and 4 to specify the second range of characters that you want to increase, the increment value, and the count value.

Example: Select A of A01. When you want to increase the number by one twice, set "Count": 02, "Incremented by": 1.

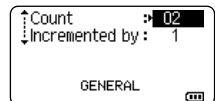
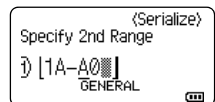

You cannot select the first character(s) because it is grayed out.

6 Press the **OK** or **Enter** key to display the screen that you set.

Example:

1A-A01	1A-A02	1A-A03	1A-A04
1A-B01	1A-B02	1A-B03	1A-B04

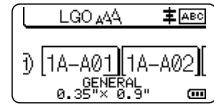

- When you press the **Shift** and **Serialize** keys, you can do the setting again. After redoing the setting, the message "OK to Overwrite the Data after This Position?" is shown. If it's ok to overwrite, press **OK** key.
- You can select All/Current/Range when printing as there are multiple pages of labels.
- To print labels refer to the User's Guide.



- Press the **Esc** key to return to the previous step.
- Serialize mode can be also applied to bar codes. A bar code is counted as a character.
- Any symbols or other non-alphanumeric characters in the auto-numbering sequence are ignored.
- Serialize mode sequence can only contain a maximum of five characters.
- The "Count" value can be set to a maximum sequence number of 99.
- The "Incremented by" value can be set in increments of one to nine.



- Letters and numbers increase as shown below:

0 → 1 ...9 → 0 → ...
 A → B ...Z → A → ...
 a → b ...z → a → ...
 A0 → A1 ...A9 → B0 → ...

Spaces (shown as underscores "_" in the example below) can be used to adjust the spacing between characters or to control the number of digits that are printed.

_9 → 10 ...99 → 00 → ...
 _Z → AA ...ZZ → AA → ...
 _1_9 → 2_0 ..._9_9 → 0_0 → ...

USING P-TOUCH SOFTWARE

Using P-touch Software

This P-touch labeling system is equipped with a USB port, allowing you to connect it to a computer. You will need to install P-touch Editor and the printer driver to use your P-touch labeling system with your computer. If you use Windows®, install P-touch Editor, the printer driver, P-touch Update Software, P-touch Transfer Manager and the Printer Setting Tool from the enclosed CD-ROM.

If you use a Macintosh, you can download the driver, software and manuals by visiting the Brother Solutions Center at <http://solutions.brother.com/>

Please visit the Brother Solutions Center (<http://solutions.brother.com/>) for the latest compatible OS.

Features

P-touch Editor	Makes it easy for anyone to create a wide variety of custom labels in complex layouts by using fonts, templates, and clip art.
Printer Driver	Lets you print labels from the connected P-touch labeling system when using P-touch Editor on your computer.
P-touch Update Software	The software can be upgraded to the latest version.
P-touch Transfer Manager	Allows you to transfer templates and other data to the printer and save backups of your data on the computer. (Windows® only)

System Requirements

Before installation, check that your system configuration meets the following requirements.

OS	Windows®	Windows Vista®/Windows® 7/ Windows® 8/ Windows® 8.1 Microsoft® Windows Server® 2008/2008 R2/2012/2012 R2
	Macintosh	OS X v10.7.5/10.8.x/10.9.x
Hard disk	Windows®	Disk space : 70 MB or more
	Macintosh	Disk space : 500 MB or more
Memory	Windows®	Windows Vista®/Windows Server® 2008/2008 R2/2012/2012 R2: 512 MB or more : Windows® 7 : 1 GB or more (32-bit) or 2 GB or more (64-bit) Windows® 8/Windows® 8.1 : 1 GB or more (32-bit) or 2 GB or more (64-bit)
	Macintosh	OS X v10.7.5 : 2 GB or more OS X v10.8.x : 2 GB or more OS X v10.9.x : 2 GB or more
Monitor	Windows®	SVGA, high color or higher graphics card
	Macintosh	256 colors or more
Others		CD-ROM drive

Installing the Software and Printer Driver

The procedure for installing the software varies depending on the OS of the computer. The installation procedure is subject to change without notice.

The P-touch labeling system names in the following screens may differ from your purchased P-touch labeling system name.

❗ DO NOT connect the P-touch labeling system to the computer until directed to do so.

■ For Windows®

- ❗ • The installation procedure may change depending on the Operating System on your PC. Windows® 7 is shown here as an example.
- If you are using Windows® 8/Windows® 8.1, use Adobe® Reader® to open the PDF manuals on the CD-ROM.
If Adobe® Reader® is installed but cannot open the files, change the ".pdf" file association to "Adobe® Reader®" from the control panel before using the CD-ROM.

- 1 Insert the installer CD-ROM into your CD-ROM drive.
If the language screen appears, choose your language.



- **For Windows Vista®/Windows® 7/Windows Server® 2008/2008 R2:**
If the installer screen does not automatically appear, display the contents of the CD-ROM drive folder, and then double-click [start.exe].
- **For Windows® 8/Windows® 8.1/Windows Server® 2012/2012 R2:**
If the installer screen does not automatically appear, click [Run start.exe] in the [Start] screen, or display the contents of the CD-ROM drive folder from the desktop, and then double-click [start.exe].

- 2 Click [Standard Installation].

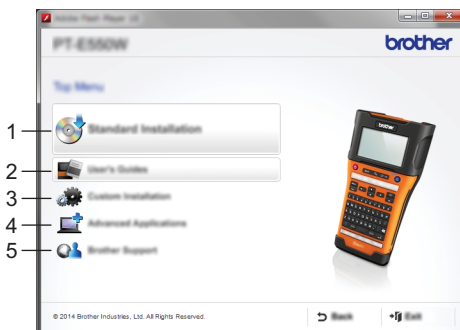

1. Standard Installation

Installs P-touch Editor, the printer driver, P-touch Update Software, the Printer Setting Tool and the User's Guides. (P-touch Transfer Manager is installed together with P-touch Editor.)

2. User's Guides

Displays or installs the User's Guides.

3. Custom Installation

Allows P-touch Editor, the printer driver, P-touch Update Software and the Printer Setting Tool to be individually selected for installation. (P-touch Transfer Manager is installed together with P-touch Editor.)

USING P-TOUCH SOFTWARE

4. Advanced Applications

Installs the BRAdmin Light utility or displays the Brother Developer Center.

5. Brother Support

Displays the support website (Brother Solutions Center).

3 Follow the on-screen instructions to complete setup.

4 The P-touch Update Software can be used to check for updates. If [OK to use P-touch Update Software to update the software to the newest version? (An Internet connection is required to update.)] appears, click [Yes] or [No].

To check for new versions of the software and to update them, click [Yes], and then go to step 5.

To not check for new software versions or update them, click [No], and then go to step 6.

 If you click [No] here, you can run the P-touch Update Software at a more convenient time to check for new software versions and update them. Double-click the P-touch Update Software icon on the desktop. (Your computer must be connected to the Internet.)

5 The P-touch Update Software starts up.

If an application appears under [File list], there is a new version of the application. If the check box is selected and [Install] is clicked, that application can be installed. Wait until a message appears indicating that the installation has finished.

If no application appears under [File list], the application currently installed on the computer is the newest version. There is no need to update. Click [Close].

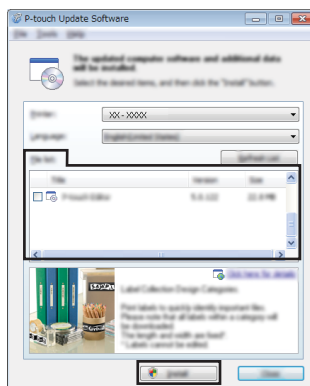

6 When the screen for the online user registration appears, click [OK] or [Cancel].

If you clicked [OK], you will go to the online user registration page before finishing the installation (recommended).

If you clicked [Cancel], installation continues.



7 Click [Finish].

The installation is now complete.

 When you are asked to restart the computer, click [Restart].



■ For Macintosh

1 Start your Macintosh, and download the driver, software and manuals from the Brother Solutions Center (<http://solutions.brother.com>).



 Macintosh users can access this URL directly by clicking the  icon found on the CD-ROM.

Uninstalling the Printer Driver

■ For Windows Vista®/Windows Server® 2008

- 1] If the P-touch labeling system is connected to the computer and is turned on, press and hold the  (Power) button to turn it off.
- 2] Click  - [Control Panel] - [Hardware and Sound] - [Printers].
- 3] Select [Brother xx-xxxx] and click [Delete this printer], or right-click the icon and click [Delete].
- 4] Right-click the [Printers] window, and then click [Run as administrator] - [Server Properties...].
If the authorization confirmation window appears, click [Continue].
If the [User Account Control] window appears, type in the password, and then click [OK].
The [Print Server Properties] window appears.
- 5] Click the [Drivers] tab, select [Brother xx-xxxx], and then click [Remove...].
- 6] Select [Remove driver and driver package], and then click [OK].
- 7] Close the [Print Server Properties] window.
The printer driver has been uninstalled.

■ For Windows® 7/Windows Server® 2008 R2

- 1] If the P-touch labeling system is connected to the computer and is turned on, press and hold the  (Power) button to turn it off.
- 2] Click  - [Devices and Printers].
- 3] Select [Brother xx-xxxx] and click [Remove device], or right-click the icon and click [Remove device].
If a User Account Control message appears, type in the password, and then click [Yes].
- 4] Select [Fax] or [Microsoft XPS Document Writer] in the [Devices and Printers] window, and then click [Print server properties], which appears on the menu bar.
- 5] Click the [Drivers] tab, and then click [Change Driver Settings].
If a User Account Control message appears, type in the password, and then click [Yes].
Select [Brother xx-xxxx], and then click [Remove...].
- 6] Select [Remove driver and driver package], and then click [OK].
Follow the on-screen instructions.
- 7] Close the [Print Server Properties] window.
The printer driver has been uninstalled.

USING P-TOUCH SOFTWARE

■ For Windows® 8/Windows® 8.1/Windows Server® 2012/2012 R2

- 1] If the P-touch labeling system is connected to the computer and is turned on, press and hold the  (Power) button to turn it off.
 - 2] Click [Control Panel] in [Apps] screen - [Hardware and Sound] - [Devices and Printers].
 - 3] Select [Brother xx-xxxx] and click [Remove device], or right-click the icon and click [Remove device].
If a User Account Control message appears, type in the password, and then click [Yes].
 - 4] Select [Fax] or [Microsoft XPS Document Writer] in the [Devices and Printers] window, and then click [Print server properties], which appeared in the menu bar.
 - 5] Click the [Drivers] tab, and then click [Change Driver Settings].
If a User Account Control message appears, type in the password, and then click [Yes].
Select [Brother xx-xxxx], and then click [Remove...].
 - 6] Select [Remove driver and driver package], and then click [OK].
Follow the on-screen instructions.
 - 7] Close the [Print Server Properties] window.
The printer driver has been uninstalled.
-

■ For OS X v10.7.5 - OS X v10.9.x

- 1] Turn off the P-touch labeling system.
 - 2] Click Apple menu and [System Preferences], and click [Print & Scan] (OS X v10.7.5 / OS X v10.8.x)/[Printers & Scanners] (OS X v10.9.x).
 - 3] Choose [Brother xx-xxxx], and click [-].
 - 4] Close the [Print & Scan] (OS X v10.7.5 / OS X v10.8.x)/[Printers & Scanners] (OS X v10.9.x) window.
The printer driver has been uninstalled.
-

Uninstalling the Software

Perform this procedure only if the software is no longer necessary or when reinstalling the software.

For details on how to uninstall the software, please refer to the Help for your OS.

brother

Printed in China
LAF498001

