

RI-02 SMD Series Dry Reed Switch

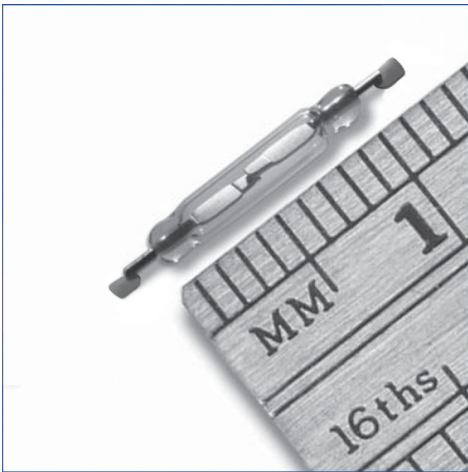

RI-02 SMD Series

Ultra-miniature dry-reed switch hermetically sealed in a gas filled envelope. Single-pole, single-throw (SPST) type, having normally open contacts, and containing two magnetically actuated reeds.

The switch is of the double-ended type and may be actuated by an electro-magnet, a permanent magnet or combination of both. The device is intended for use in sensors, relays, pulse counters or similar devices.

RI-02 SMD Series Features

- Ideal for general purpose reed relays and sensors.
- Contact layers: ruthenium on gold
- Superior glass-to-metal seal and blade alignment
- RoHS Compliant

Dimensions for RI-02 SMD Series *All Dimension in inches (mm) nominal*

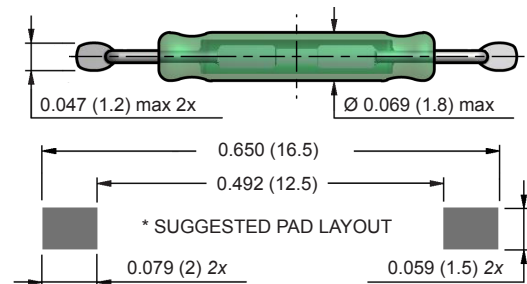
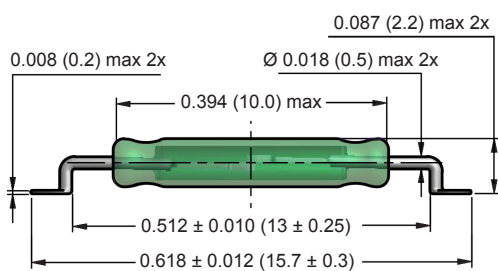

** For other pad layouts please contact us.*

Technical Specifications

Parameters	Test Conditions	Units	RI-02
Operating Characteristics			
Operate Range		AT	7-21
Release Range		AT	3 (min)
Operate Time - including Bounce (typ.)		ms	0.30
Bounce Time (typ.)		ms	0.10
Release Time (max)		µs	70
Resonant Frequency (typ.)		Hz	10800
Electrical Characteristics			
Switched Power (max)		W	10
Switched Voltage DC (max)		V	200
Switched Voltage AC, RMS value (max)		V	140
Switched Current DC (max)		mA	500
Switched Current AC, RMS value (max)		mA	500
Carry Current DC (max)		A	0.5
Breakdown Voltage (min)		V	200 - 230
Contact Resistance (initial max.)		mΩ	150
Contact Resistance (initial typ.)		mΩ	120
Contact Capacitance (max)	without test coil	pF	0.3
Insulation Resistance (min)	RH ≤ 45%	MΩ	10 ⁶

RI-02 SMD Series Dry Reed Switch

Based on standard RI-02 models

ORDERING INFORMATION

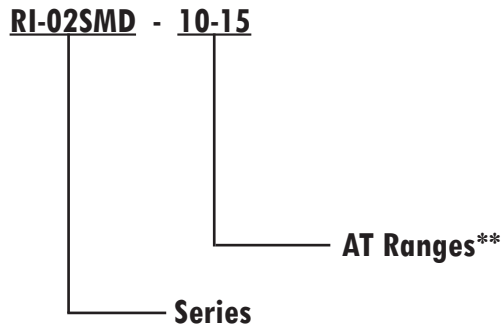

***Customer specific AT ranges are possible. Please contact your local sales representative.*

Coils

All characteristics are measured using the Philips Standard Coil. For definitions of the Philips Standard Coil, refer to "Application Notes" in the *Reed Switch Technical & Application Information* Section of this catalog.

Life expectancy and reliability

The life expectancy data given below are valid for a coil energized at 1.25 times the published maximum operate value for each type in the RI-02 series.

No load conditions (operating frequency: 100Hz)

Life expectancy: min. 10^8 operations with a failure rate of less than 2×10^{-10} with a confidence level of 90%.

End of life criteria:

- Contact resistance $> 1\Omega$ after 2 ms
- Release time > 2 ms (latching or contact sticking).

Loaded conditions (resistive load: 5 V; 100 mA; operating frequency: 125 Hz)

Life expectancy: min. 2×10^6 operations with a failure rate of less than 10^{-8} with a confidence level of 90%.

End of life criteria:

- Contact resistance $> 1\Omega$ after 2.5 ms
- Release time > 1 ms (latching or contact sticking).

Loaded conditions (resistive load: 20 V; 500 mA; operating frequency: 125 Hz)

Life expectancy: min. 2×10^6 operations with a failure rate of less than 10^{-7} with a confidence level of 90%.

End of life criteria:

- Contact resistance $> 2\Omega$ after 2.5 ms
- Release time > 2.5 ms (latching or contact sticking).

Switching different loads involves different life expectancy and reliability data. Further information is available on

request.

Mechanical Data

Contact arrangement is normally open; lead finish is tinned; net mass is approximately 90mg; and can be mounted in any position.

Shock

The switches are tested in accordance with "IEC 68-2-27", test Ea (peak acceleration 100 G; half sinewave; duration 11ms). Such a shock will not cause an open switch (no magnetic field present) to close, nor a switch kept closed by an 80 AT coil to open.

Vibration

The switches are tested in accordance with "IEC 68-2-26", test Fc (acceleration 10G; below cross-over-frequency 57 to 62 Hz; amplitude 0.75 mm; frequency range 10 to 2000 Hz; duration 90 minutes.) Such a vibration will not cause an open switch (no magnetic field present) to close, nor a switch kept closed by an 80 AT coil to open.

Mechanical Strength

The robustness of the terminations is tested in accordance with "IEC 68-2-21", test Ua1 (load 10 N).

Operating and Storage Temperature

Operating ambient temperature; min: -55°C ; max: $+125^\circ\text{C}$. Storage temperature; min: -55° ; max: $+125^\circ\text{C}$. Note: Temperature excursions up to 150°C may be permissible. For more information contact your nearest Comus Group sales office.

Soldering

The switch can withstand soldering heat in accordance with "IEC 68-2-20", test Tb, method 1B: solder bath at $350 \pm 10^\circ\text{C}$ for 3.5 ± 0.5 s. Solderability is tested in accordance with "IEC 68-2-20" test Ta, method 3: solder globule temperature 235°C ; ageing 1b: 4 hours steam.

Through-hole Reed Switches

The attachment method is typically eutectic soldering. RoHS requires solder with no elemental lead (Pb). SAC alloy (96,5Sn / 3AG / 0,5Cu) is the most popular choice. Reed switches can be soldered by hand or by wave solder processing. Comus Technology recommends the maximum wave solder temperature (measured at the reed switch leads) as 270°C for 10 seconds. Temperature and time in excess of the recommended levels may result in damage to the reed switch. All of our through-hole reed switches will be compatible with either SAC alloy or eutectic soldering process.

RI-02 SMD Series Dry Reed Switch

Surface Mounted Reed Switches

The most common method of attachment is by SMD processing - stencil/screen solder paste, then oven reflow. Due to board thickness, component density, and other circumstances that dictate the required reflow temperature, Comus Technology uses a higher temperature solder for all internal connections. We recommend that the temperature (measured at the reed switch leads) does not exceed 260°C for 1 minute. Temperature and time in excess of the recommended levels may result in damage to the reed switch.

Handling Force

When possible don't add pressure on the glass on placing

the reed switch on a pcb or device. However when handling with a Pick and Place machine the acceptable force on the reed switch is 3N with a max of 5N.

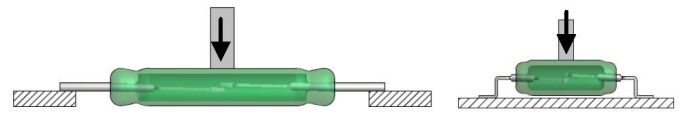

* As part of the company policy of continued product improvement, specifications may change without notice. Our sales office will be pleased to help you with the latest information on this product range and the details of our full design and manufacturing service. All products are supplied to our standard conditions of sale unless otherwise agreed in writing.

Recommended Soldering Reflow Profile

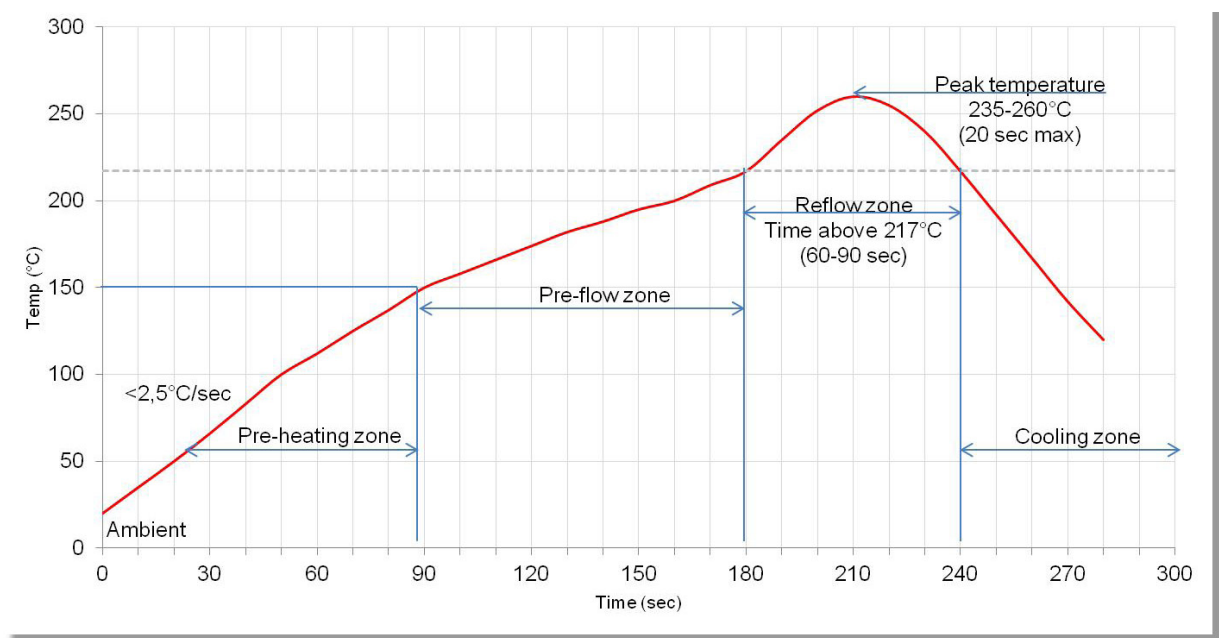

Dimensions for RI-02 SMD Tape and Reel

All Dimension in inches (mm) nominal

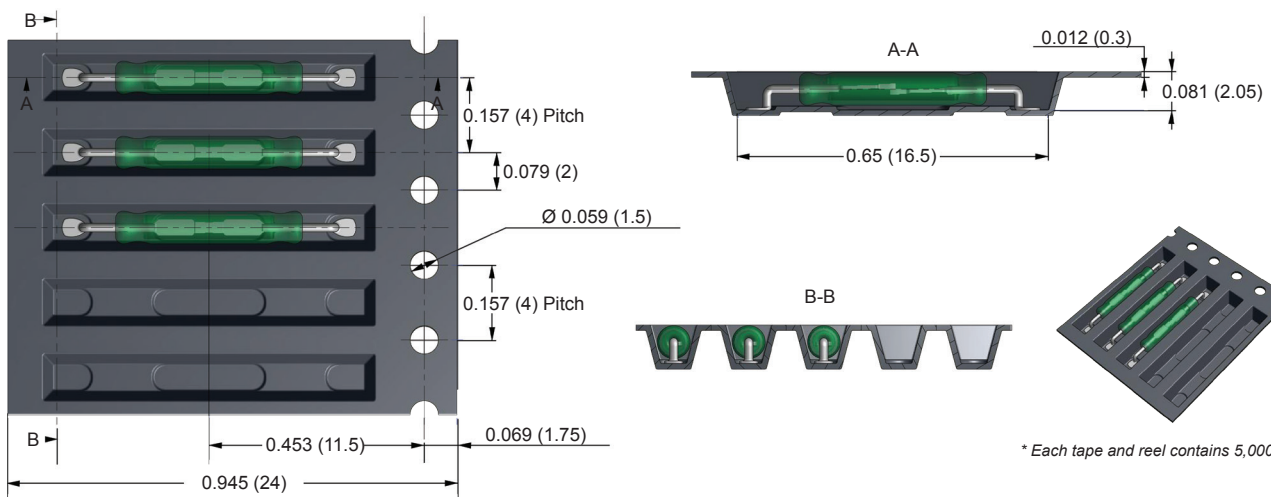

RI-02 SMD Series Dry Reed Switch



Comus International
454 Allwood Road
Clifton, New Jersey 07012
U.S.A

Tel: (1)973 - 777 - 6900
Fax: (1)973 - 777 - 8405
email: info@comus-intl.com
Website: <http://www.comus-intl.com>
ISO 9001:2008
CERTIFICATE NO: 03-12314



Comus Europe Ltd
Unit 7, Rice Bridge Industrial Estate
Thorpe - Le - Soken
Essex, England
CO160HL
Tel: +44 (0)1255 862236
Fax: +44 (0)1255 862014
email: sales@comuseurope.co.uk
Website: <http://www.comuseurope.co.uk>
ISO 9001:2008
CERTIFICATE NO: FM 21080



Comus Belgium BVBA
Overhaamlaan 40
B-3700 Tongeren
Belgium

Tel: +33 (0)12 390400
Fax: +33 (0)12 235754
email: info@comus.be
Website: <http://www.comus.be>



Comus Technology BV
Jan Campertstraat 11
6416 SG Heerlen
The Netherlands

Tel: +31(0)45 5439345
Fax: +31(0)45 5427216
email: info@comus-intl.com
Website: <http://www.dry-reeds.com>



Comus Electronics and Technologies
India Private Limited
2nd Floor, No.31/33, Anjugam Nagar
2nd Street, Ashok Nagar, Jaferkhanpet
Chennai 600083
Tamil Nadu, India
Tel:+(91)-(44)-42023510
Fax:+(91)-(44)-22628198
email: info@comus-intl.com
Website: <http://www.comusindia.com>

TAKE A LOOK AT OUR VARIETY OF PRODUCTS



Float Switches

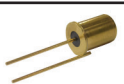

Acceleration / Shock Switches



Movement Sensors



Tilt / Tip Switches



Reed Relays



Solid State Relays



High Breakdown Switches



Reed Switches



Magnets



Smart Sensors



Optical Level Switches



Alarm / Security Switches