

LK-Baseboard for Raspberry Pi B+ / Pi 2

Dear customer,

thank you for your purchase of our product. In the next few pages we've described, what you'll need to know for operating our product:

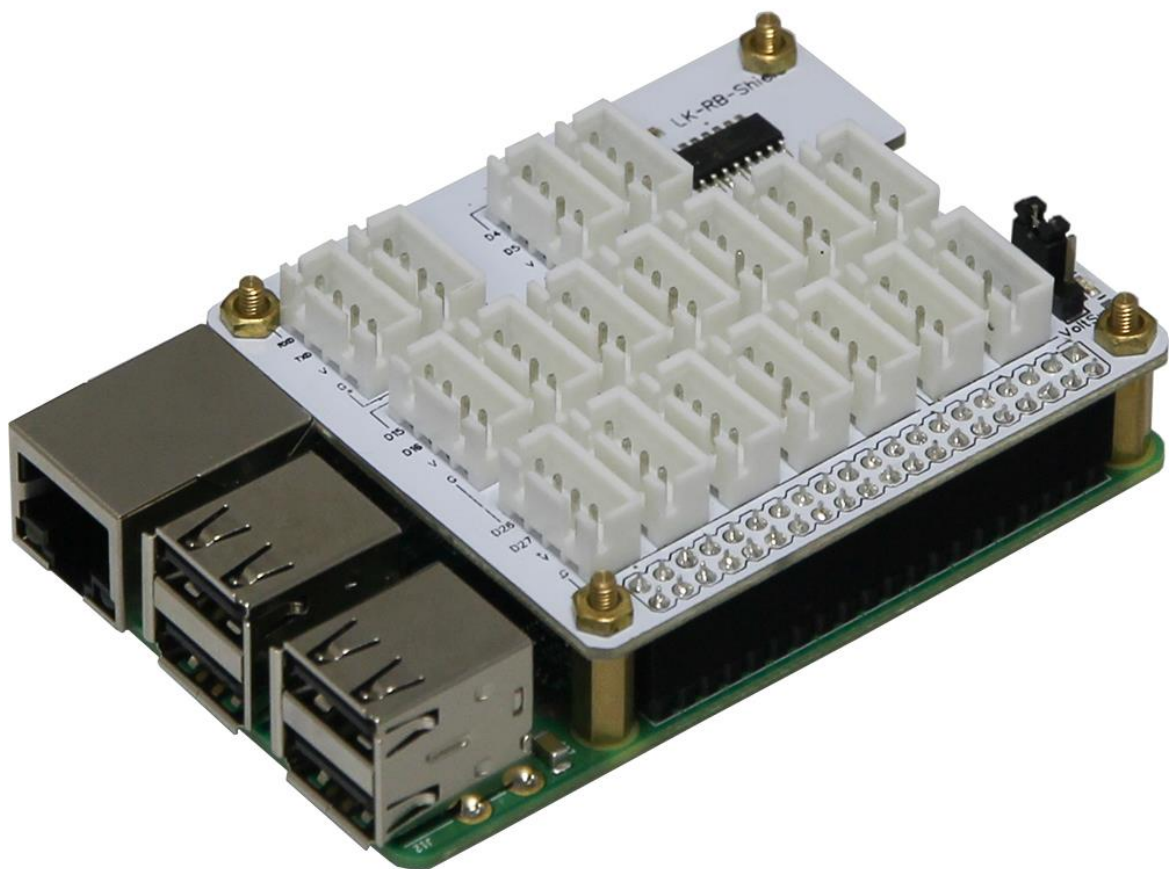

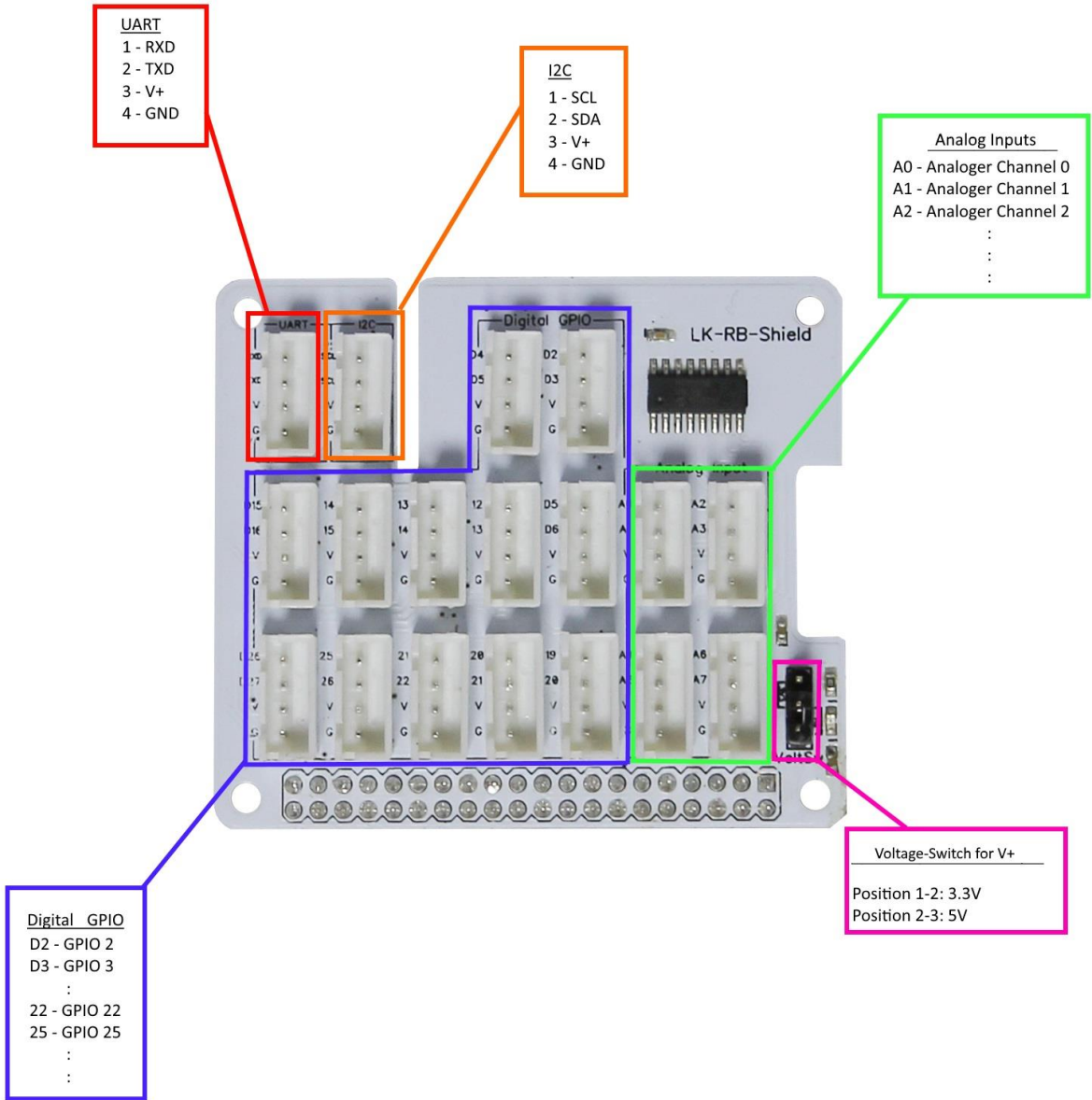

Control the analog inputs through the MCP3008

1. Installation of the needed modules

We recommend to use an actual Raspbian OS-Image (Debian Wheezy). In our first step we've to activate the SPI-Interface of the Raspberry Pi, to make the communication with the ADC of the LK- Base board possible. For this, we're starting with the following command:

```
sudo raspi-config
```

There will appear a new window, where we choose „Advanced Options“

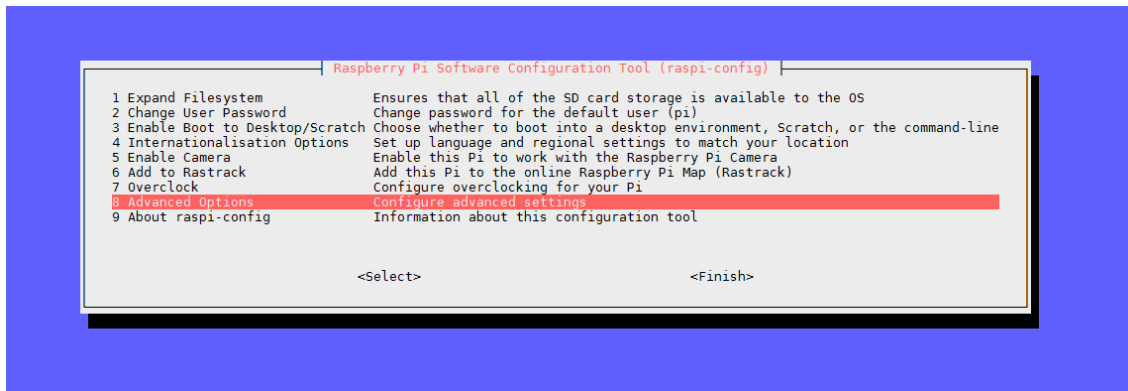

Then we go on „A6 SPI“

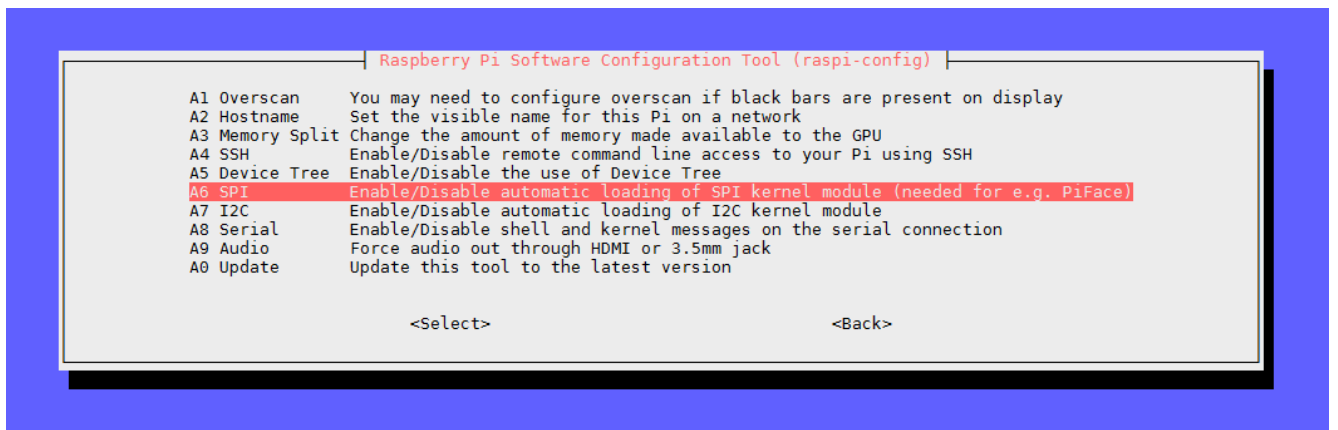

The next two windows have to be accepted with „Yes“ and „OK“

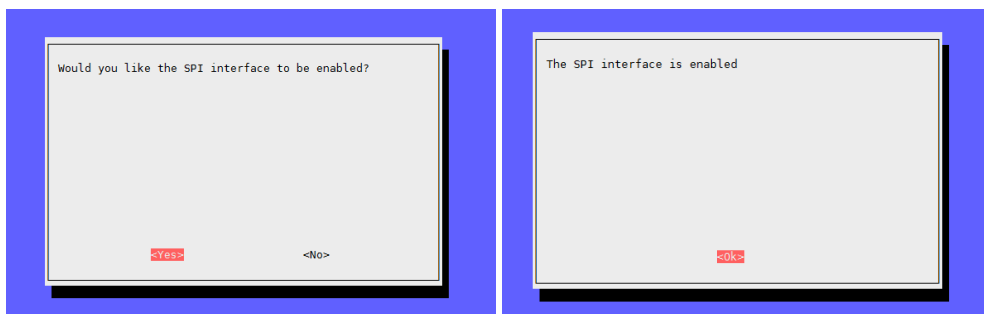

Also the next two ones...

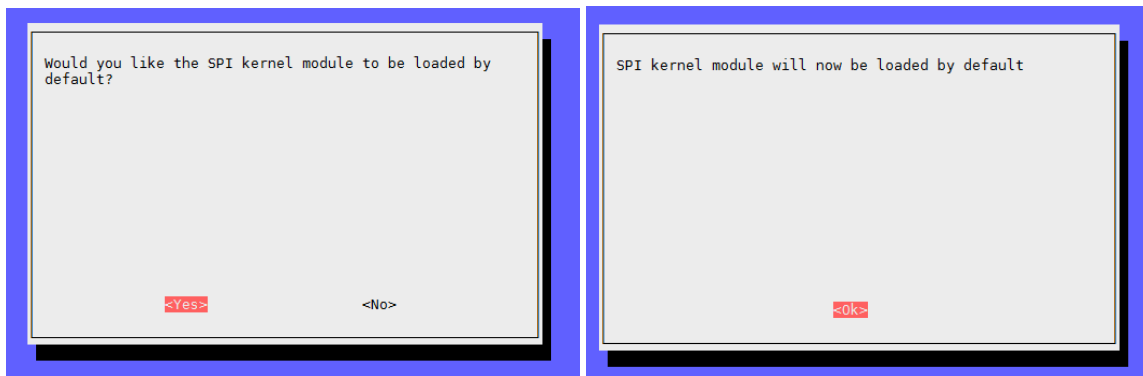

Finally we go on „Finish“ to close the Configuration Tool...

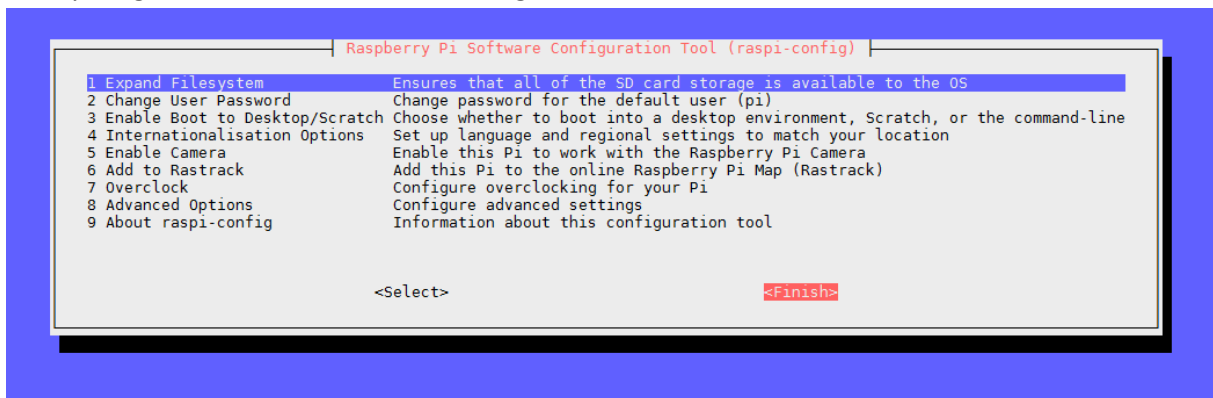

...and reboot the Raspberry Pi with the following command:

```
sudo reboot
```

After the Reboot, we've to load and install the needed Drivers and Modules. For this you have to put the following commands in the console of the Raspberry Pi and confirm each with a Press on [Enter]. In this procedure the Raspberry Pi have to be connected to the Internet:

```
sudo apt-get update
```

```
sudo apt-get install python-imaging python-imaging-tk python-pip python-dev git
```

```
sudo pip install spidev
```

```
sudo pip install wiringpi
```

Also after this you have to reboot:

```
sudo reboot
```

Python-Example for using the MCP3008 ADC Controller - testadc.py

```
import spidev
import time
import sys

spi = spidev.SpiDev()
spi.open(0,0)

def readadc(adcnnum):
    if adcnnum >7 or adcnnum <0:
        return-1
    r = spi.xfer2([[1,8+adcnnum <<4,0]])
    adcout = ((r[1] &3) <<8)+r[2]
    return adcout

while True:
    if len(sys.argv) >1:
        for i in range(len(sys.argv)):
            if i == 0:
                print "_____ \n"
            else:
                adc_channel = int(sys.argv[i])
                print "Channel " + str(adc_channel)
                value=readadc(adc_channel)
                volts=(value*3.3)/1024
                print("%4d/1023 => %5.3f V" % (value, volts))
                print " "
                print "_____ \n"
                time.sleep(1.5)
            else:
                print "_____ \n"
                print "Channel 0"
                value=readadc(0)
                volts=(value*3.3)/1024
                print("%4d/1023 => %5.3f V" % (value, volts))
                print "Channel 1"
                value=readadc(1)
                volts=(value*3.3)/1024
                print("%4d/1023 => %5.3f V" % (value, volts))
                print "Channel 2"
                value=readadc(2)
                volts=(value*3.3)/1024
                print("%4d/1023 => %5.3f V" % (value, volts))
                print "Channel 3"
                value=readadc(3)
                volts=(value*3.3)/1024
                print("%4d/1023 => %5.3f V" % (value, volts))
                print "Channel 4"
                value=readadc(4)
                volts=(value*3.3)/1024
                print("%4d/1023 => %5.3f V" % (value, volts))
                print "Channel 5"
                value=readadc(5)
                volts=(value*3.3)/1024
                print("%4d/1023 => %5.3f V" % (value, volts))
                print "Channel 6"
                value=readadc(6)
                volts=(value*3.3)/1024
                print("%4d/1023 => %5.3f V" % (value, volts))
                print "Channel 7"
                value=readadc(7)
                volts=(value*3.3)/1024
                print("%4d/1023 => %5.3f V" % (value, volts))
                print "_____ \n"
                time.sleep(1.5)
```

The file „testadc.py“ shows a way, how to measure analog voltage Level with a python script; with the function readadc() and a specified Channel (0-7) you can read out the actual value.

Create a file with the name „testadc.py“ and copy the script shown above in this file (please make sure, that you don't miss any spaces).

The script can now be used in two different ways:

Output the values of all ADC-Channels simultaneously:

```
sudo python testadc.py
```

This command causes that the values of all ADC-Channels are read out and displayed every 1.5s.

```
Channel 0
513/1023 => 1.653 V
Channel 1
519/1023 => 1.673 V
Channel 2
0/1023 => 0.000 V
Channel 3
0/1023 => 0.000 V
Channel 4
0/1023 => 0.000 V
Channel 5
0/1023 => 0.000 V
Channel 6
0/1023 => 0.000 V
Channel 7
0/1023 => 0.000 V
```

Output of values from specific Channels:

```
sudo python testadc.py 3 7
```

You can also read out the values from individual channels – specify them with their channel number directly after the command, separated with a spacer. In this example this would be the channels [3] und [7]

```
Channel 3
518/1023 => 1.669 V

Channel 7
1/1023 => 0.003 V
```