

Grease gun ST



English



CE





Item no.: 2010244

Please read these operating instructions carefully before using the device.





EN	Complaints and orders for replacement parts are processed quickly and efficiently. Please contact us using the information below.		
	Tel.: +49 6182 / 99387-0	Fax: +49 6182 / 99387-20	info@aerotec.info

Labelling:



Product safety – prohibition signs:

			
Complies with EU standards	Prohibition sign	No loose clothing!	No jewellery etc.

Warning – mandatory action signs:

			
CAUTION/WARNING	Observe operating instructions	Wear hearing protection	Wear eye protection

Environmental protection:

		
Dispose of properly	Cardboard packaging material can be recycled at designated collection points.	Electrical or electronic devices that are faulty or are ready for disposal must be recycled at designated collection points.

EC declaration of conformity
 We the supplier,
 pro)SALES GmbH
 Ferdinand-Porsche-Straße 16
 63500 Seligenstadt
 Germany

hereby declare that the following designated devices, based on their design and type as well as the versions placed on the market by us, meet the relevant fundamental health and safety requirements set out in the EU Directives.

Any modification to the devices not approved by us invalidates this declaration of conformity.

Device designation: Grease gun ST, item no.: 2010244

Date/Signature of manufacturer: 22/01/2013 
 Information on the signatory: Mr Markert, Managing Director
Relevant EU Directives:
 2006/42/EC
Applicable harmonised standards: EN 792;
 EN 50144

Technical data:

Grease gun ST	
Operating pressure:	2–6.3 bar
Air consumption per stroke:	0.5 l/min
Threaded connection:	1/4"
internal Rec. hose cross-section:	6 mm
Capacity:	450 ml
Weight:	1.4 kg
Item no.	2010244

Included in delivery:

- 1 x grease gun ST
- 1 x SK nipple 1/4" external
- 1 x operating instructions
- 1 x flexible grease hose
- 1 x rigid grease pipe

General safety instructions:



Safety note! Failure to comply with the following instructions may lead to injuries.

Read all instructions very carefully before using the air tool. All users must be fully aware and sufficiently informed of the safety requirements when using air tools. Any servicing or repair work must only be performed by trained specialists. Always ensure that the work surface and working position of the tool are stable and secure before using the tool.

Ensure that all locking pieces are secure before use. Regularly inspect the pneumatic hose and all connections for wear or damage. Always carry the tool by its handle and not by the hose. Never exceed the recommended maximum operating pressure (6.3 bar).

The tool is not earthed or electrically insulated. Never use the tool where there is a risk of contact with electricity.

We recommend disconnecting the air supply when filling the cartridge. The trigger switch must not be operated during this process.

If the tool exhibits signs of irregular function and performance during use, stop using it immediately and have the device serviced or repaired.

Do not use unnecessarily long pressure hoses in order to prevent tripping.

Read the operating instructions for the compressor and follow the safety instructions for using the compressor.

ALWAYS wear certified eye protection and hearing protection. Take off watches, rings and other items that may be problematic. Loose clothing or jewellery may get caught in the air compressor or in the air tool and lead to injuries.

The trigger switch must not be operated when the device is connected to the air supply. Disconnect the device from the air supply when it is not in use. NEVER change accessories or carry out ANY maintenance work as long as the device is connected to the air supply. Carry out proper maintenance on the device and follow all instructions for lubrication and tool maintenance. Do not carry the device by the hose or rip the hose from the air supply, as this may damage the hose and connection parts. Do not allow the hose to come into contact with heat or sharp edges. The hose should be replaced if it is damaged or worn. NEVER operate the device with an air pressure exceeding 6.3 bar. Use a pressure controller that reduces the air pressure to 6.3 bar. ALWAYS operate the device a safe distance away from other people or animals.

Before starting:

The pneumatic grease gun has been designed in accordance with the state of the art and recognised technical safety regulations. Improper use of the device, however, can pose a risk of injury or death to the user or other or lead to damage to the device itself and/or to other objects. The grease gun is predominately used in the agricultural sector to lubricate couplings or bearings with grease using grease nipples or special grease fittings. Pressing the trigger lever releases the material inside the cartridge out of the nozzle at the front of the gun and onto the corresponding surface. This tool must only be powered by an air compressor. The pneumatic connection must be formed using a threaded plug nipple (included in delivery) and a quick coupling. Any other use that deviates or goes beyond this description is considered improper use. The user accepts responsibility for the associated risk.



**Safety note!
Wear eye protection! Wear hearing protection!**

Ensure that only compressed air that is condensate-free is used for operation. It is sufficient to connect a filter water separator upstream.

Then start the air compressor. The maximum operating air pressure for the tool is 6.3 bar. The operating pressure can be set on your compressor using a pressure controller. Maintenance and care

Cleaning:

1. Clean the gun after every use. Do not use an aggressive solvent.
2. The locking screw in particular should be cleaned thoroughly in order to prevent it getting stuck.

Troubleshooting

Problem	Possible cause	Solution
Trigger lever is pressed but gun does not function	Insufficient air pressure, hose diameter is too small Grease is too hard	Check the air pressure at the inlet. It must be at least 6.3 bar. Warm up the grease.
	Check whether the tool is connected to the compressor	Connect the tool.
	Trigger lever is faulty	Replace the trigger lever

Little or no material is dispensed from the grease gun	Insufficient air pressure, hose diameter is too small	Check the air pressure at the inlet. It must be at least 6.3 bar.
	Nozzle is clogged	Use a new nozzle.
	Cartridge is empty	Refill the cartridge.
	Air hose is not leak-tight	Check all hose fittings.

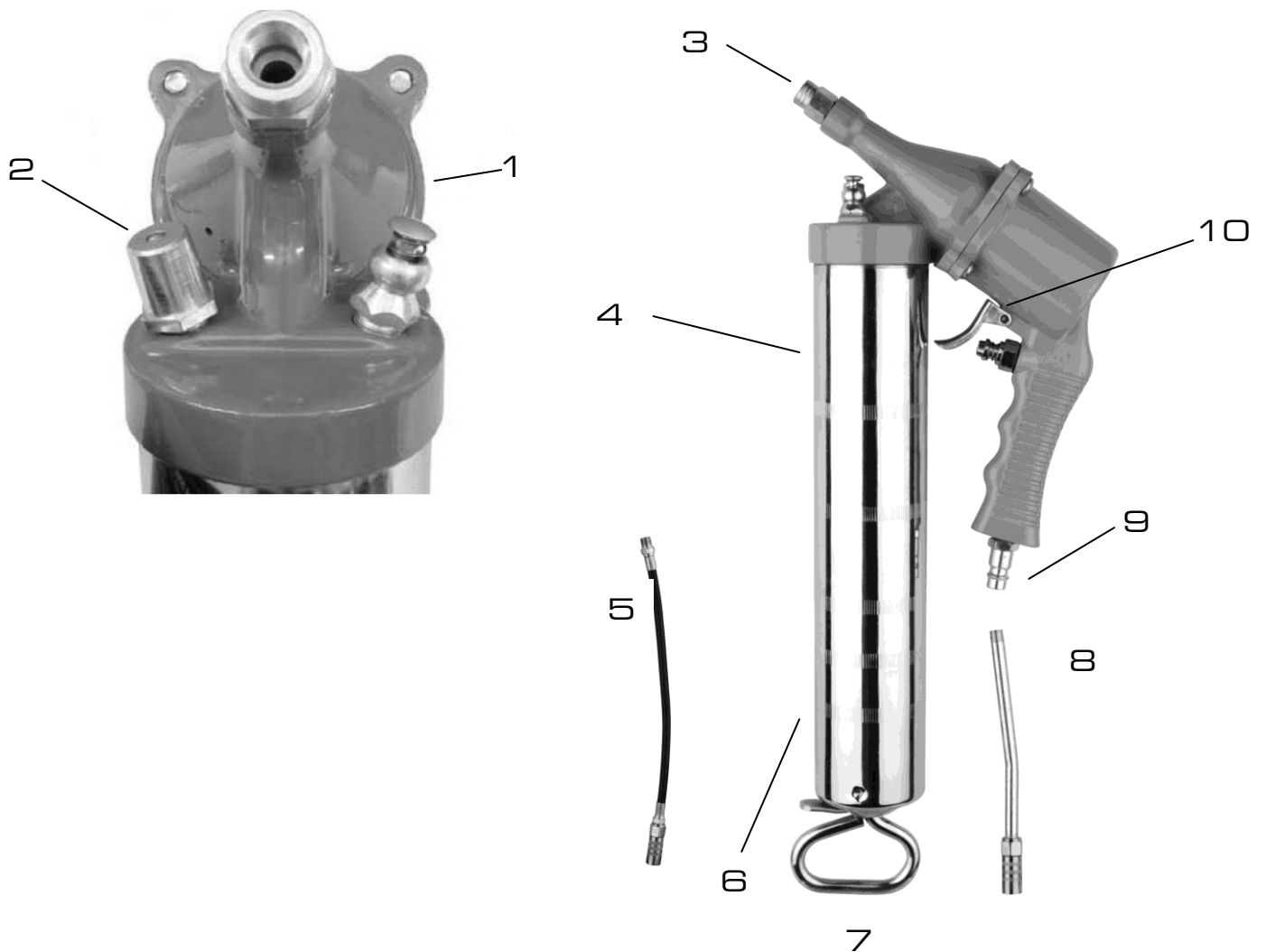

1. Bleed valve
2. Nipple for filling the tool from bulk packages
3. Threaded connection either for plunger (7) or flexible grease hose (5)
4. Grease sleeve
5. Flexible grease hose
6. Plunger release
7. Sleeve valve
8. Rigid grease nozzle
9. Pneumatic connection SK
10. Trigger lever

Filling process

1. Manual filling:

Unscrew grease holder (4) anticlockwise. Press and hold plunger release (6) and slowly pull back plunger (7) until it stops. The grease can now be poured into the holder. After filling, screw holder (4) into the housing again, this time in a clockwise direction. Ensure that the threading is clean during this process. You can also insert conventional grease cartridges. In this case, ensure that no remaining packaging is found in the grease holder after filling.

2. Filling station:

Grease from bulk packages can be pressed directly into the grease holder via filling nipple (2). Before filling, press and hold plunger release (6) and slowly pull back plunger (7) until it stops. The holder can now be filled.