

# WFR-27C

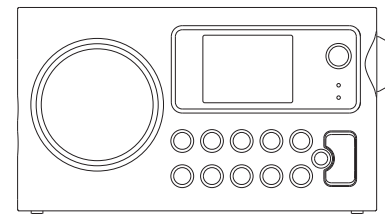

**GB**

Revision 1



"Made for iPod," "Made for iPhone," and "Made for iPad" mean that an electronic accessory has been designed to connect specifically to iPod, iPhone, or iPad, respectively, and has been certified by the developer to meet Apple performance standards. Apple is not responsible for the operation of this device or its compliance with safety and regulatory standards. Please note that the use of this accessory with iPod, iPhone, or iPad may affect wireless performance.



The iSangean App enables remote control of the WFR-27C running on your iPhone, iPod touch, iPad or Android smartphone.

iSangean is the remote control app for Sangean Internet radios and media streamers for your iPhone, iPod touch, iPad or Android smartphone. The app allows selection of Internet radio stations, selection and control of media for UPnP/DLNA music streaming from a local computer, server or NAS device, as well as control of FM radio and other functions (where these functions are present on the radio). The Now Playing screen provides radio station or media information with direct control of the radio volume.

Download iSangean from Apple iTunes (Apple Store) and Google Play now!

## Contents

<b>Introduction</b> .....	<b>3-7</b>	<i>Dynamic Range Control Settings</i> .....	50
<i>Before you can use this product</i> .....	3-4	<i>Station order setup</i> .....	51
<i>Controls and connections</i> .....	5-6	<i>Prune stations</i> .....	52
<i>Navigation controls</i> .....	7	<b>FM mode</b> .....	<b>53-58</b>
<b>Network configuration</b> .....	<b>8-16</b>	<i>Manual tuning</i> .....	54
<i>Connecting your radio to your computer network</i> .....	8-15	<i>Scan setting</i> .....	56
<i>Network remote control options</i> .....	16	<i>Stereo / Mono switching</i> .....	57
<b>Internet Radio mode</b> .....	<b>17-31</b>	<i>Presetting stations in DAB and FM modes</i> .....	58
<i>Internet Radio-the basics</i> .....	17	<b>Listening to Spotify</b> .....	<b>59-62</b>
<i>Selecting a radio station by location and genre</i> .....	18-20	<b>Clock and Alarms</b> .....	<b>63-73</b>
<i>Searching for a radio station by name</i> .....	21	<i>Automatically updating the clock</i> .....	63
<i>Searching a new or popular station</i> .....	22	<i>Setting the clock format</i> .....	64
<i>Selecting a podcast / BBC Listen Again</i> .....	23	<i>Manually setting the clock</i> .....	65-66
<i>Presetting stations</i> .....	24	<i>Setting the alarm clock</i> .....	67-69
<i>Display modes</i> .....	26	<i>Snooze timer</i> .....	71
<i>Customizing your radio</i> .....	27	<i>Disabling alarms</i> .....	71
<i>Selecting favorite stations</i> .....	29-31	<i>Sleep timer</i> .....	72
<b>Music Player mode</b> .....	<b>32-48</b>	<i>Inactive standby</i> .....	73
<i>Use with Windows, Apple Mac and Linux</i> .....	31	<b>Display and Auto</b> .....	<b>74-77</b>
<i>Accessing your files via UPnP</i> .....	32-33	<i>Equalizer function</i> .....	74
<i>Locating and playing media files using UPnP</i> .....	34	<i>Brightness control</i> .....	76
<i>Media selection</i> .....	35	<i>Language selection</i> .....	77
<i>Controlling playback</i> .....	36	<i>Headphone socket</i> .....	77
<i>Display modes</i> .....	38	<b>Information</b> .....	<b>78-86</b>
<i>Playlists</i> .....	39	<i>Factory reset</i> .....	78
<i>Wake On LAN</i> .....	42	<i>Software update</i> .....	79
<i>Prune servers</i> .....	42	<i>Network profiles</i> .....	80
<i>Windows 7 'Play to' function (UPnP renderer)</i> .....	43-44	<i>Software version display and Audio FAQ</i> .....	81
<b>DAB mode</b> .....	<b>45-52</b>	<i>Accessing your audio files via a UPnP server using Windows Vista and XP</i> .....	82-83
<i>Selecting a DAB radio station</i> .....	46	<i>Audio codecs</i> .....	84
<i>Display modes</i> .....	47	<i>Cautions and Specifications</i> .....	85-86
<i>Finding new DAB radio stations</i> .....	48		
<i>Manual Tuning</i> .....	49		

## Before you can use this product

Before you can use your internet radio, you must have the following:

- A broadband Internet connection (not required for DAB, FM or Music Player functions).
- A wireless access point (WiFi) connection connected to your broadband Internet Service Provider, preferably via a router. In many cases the broadband modem, router and wireless access point will be a single combined unit supplied by your Internet Service Provider or bought from a computer store.
- If your wireless network is configured to use Wired Equivalent Privacy (WEP) or WiFi Protected Access (WPA/WPA2) data encryption then you either need to know the WEP, WPA or WPA2 key used for encryption so you can get the internet radio to communicate with the network, or your router needs to offer WiFi Protected Setup (WPS).

If connecting using WiFi, the internet radio will typically work within a 10-20 metre radio from your wireless access point. The actual range achieved will depend upon the building type, other nearby wireless network, and possible interference sources. DAB and FM radio functions can operate wherever the internet radio is able to receive a suitable broadcast signal.

### **IMPORTANT:**

Before you continue, make sure that your wireless access point or router is powered up and working with your broadband Internet service (use your computer to verify this). To get this part of the system working you must read the instructions supplied with the wireless access point or router.

## Battery operation

### **Battery operation using alkaline batteries**

1. Remove the battery cover on the rear of the unit by pressing the catch.

#### **Note:**

Before you insert the batteries, if you use non-rechargeable batteries, make sure the NiMH/Alkaline switch which located inside the battery compartment is switched to Alkaline position. If you use rechargeable batteries, make sure to switch NiMH/Alkaline switch to NiMH position.

2. Insert 6 UM-3 (AA size) batteries into the spaces in the compartment.
3. Take care to ensure all batteries are inserted with correct polarity as shown on the rear cabinet. Replace the battery cover.
4. Reduced power, distortion and a “stuttering sound” are all signs that the batteries need replacing.
5. If the radio is not to be used for any extended period of time, it is recommended that the batteries are removed from the radio.

#### **IMPORTANT:**

The batteries shall not be exposed to excessive heat such as sunshine, fire or the like.

## Battery operation using rechargeable batteries

1. Slide the battery switch to the NiHM position.
2. Insert 6 UM-3 batteries into spaces in the compartment. Make sure all batteries are inserted with the correct polarity as shown on the rear cabinet. The radio is also designed to be used with NiMH rechargeable batteries.

### **Note:**

- Do not use a mix of old and new rechargeable batteries.
- Do not use a mix of full and empty rechargeable batteries.
- Do not use batteries that have a different mAh capacity
- Do not use damaged or leaking batteries

3. Make sure the radio is switched off and connected to the AC adaptor. When the charge indicator flashes yellow indicating batteries are charging. Batteries will be fully charged in around 10 hours. The battery shows steady yellow light when the battery charging is complete.

### **Note:**

Duration for charging your battery fully can be varied according to the mAh capacity of a battery. Higher mAh batteries required longer charging time.

### **Important:**

Under some conditions the charging LED indicator may switch off after flashing briefly. This may happen if the batteries are already freshly charged, or if the radio detects that you may be attempting to recharge alkaline batteries or mixed different types or capacity of rechargeable battery. In these cases the charging will be stopped.

## Using the AC power adaptor

The AC power adaptor required for this unit should be 12 volts DC at 1A center pin positive.

Insert the adaptor plug into the DC socket on the left side of the radio.

Plug the adaptor into a standard mains socket outlet.

Whenever the adaptor is used, the batteries are automatically disconnected. The AC adaptor should be disconnected from the main supply when not in use.

## Controls and connections

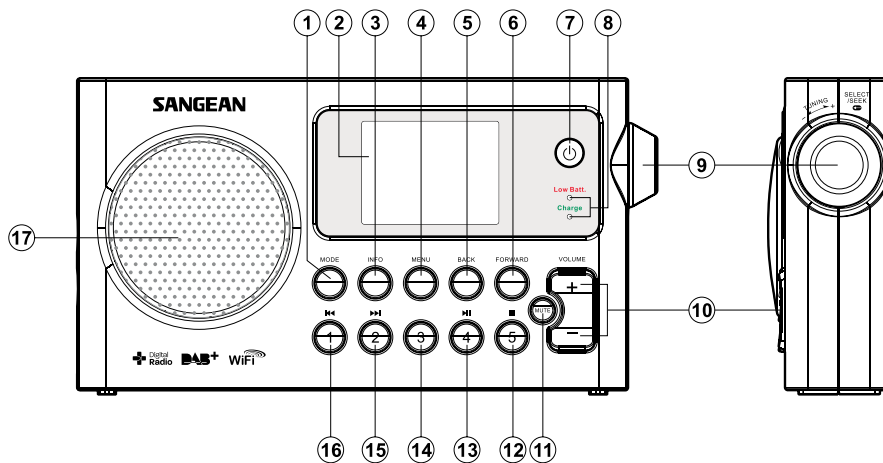

- |  |  |
|--|--|
| 1. Mode button   | 9. Tuning Control Rotary / Select knob |
| 2. LCD display   | 10. Volume button                      |
| 3. Info button   | 11. Mute button                        |
| 4. Menu button   | 12. Preset 5 / Stop button             |
| 5. Back button   | 13. Preset 4 / play / pause button     |
| 6. Forward button                                      | 14. Preset 3                           |
| 7. Standby button                                      | 15. Preset 2 / Rewind button           |
| 8. Battery charge indicator /<br>Low battery indicator | 16. Preset 1 / Fast-forward button     |
|  | 17. Loud speaker                       |

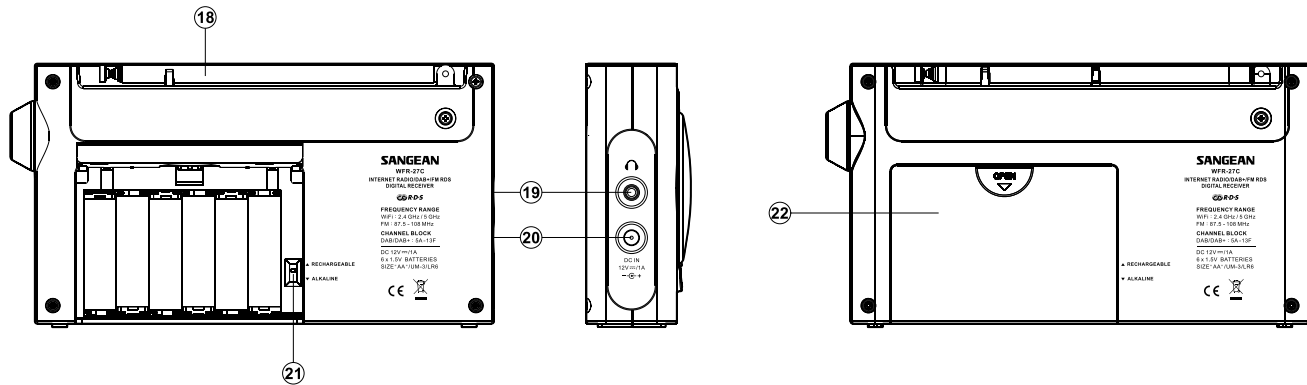

- 18. FM telescopic aerial
- 19. Headphone jack
- 20. DC in jack
- 21. Alkaline / NiMH / NiCad  
rechargeable battery switch
- 22. Battery compartment

## Navigation controls

This page describes the basic means of controlling your WFR-27C internet radio.

Instructions for each operating mode are given in the later section of this book.

1. Pressing the **Standby** button brings your radio out of Standby mode. Pressing Standby while the radio is in use will cause it to return to the Standby mode with the clock display.
2. Pressing the **Mode** button gives you access to each of the operating modes: Internet Radio, DAB+ radio, Music player, FM radio.
3. Pressing the **Menu** button will access the menu system, whereas the Info button allows the display of information relating to the radio station or music file being played.
4. Many operations require the user to make a selection from the menu. Highlight the menu item using the **Tuning Control Rotary** on the right side of the radio. Press the **Tuning Control Rotary** to select that item. If there are more than five items in a menu, then the display will automatically scroll up or down so that the additional items become visible. If there are many items in a menu, then the radio allows the menu to “wrap around” in either direction. This can make it easier to reach items at the end of a long menu, such as a list of countries or Internet radio stations.
5. If an error is made when navigating the menus, it is generally possible to go back to a higher level menu by pressing the **Back** button.



MODE



MENU



INFO

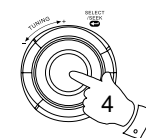
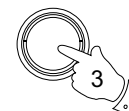

BACK

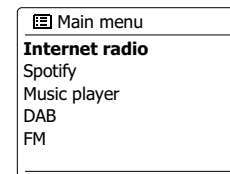



## Configuration

### Connecting your radio to your computer network

1. Place your radio on a flat surface and plug the mains lead into the mains socket located on the left side of your radio ensuring that the plug is pushed fully into the socket.
2. Plug the other end of the mains lead into the wall socket and switch on the wall socket.

**IMPORTANT:** The mains plug is used as the means of connecting the radio to the mains supply. The mains socket used for the radio must remain accessible during normal use. In order to disconnect the radio from the mains completely, the mains plug should be removed from the mains socket outlet completely.

3. When you apply power, the display on the radio will light up and say: 'SANGEAN'. The first time that you use your radio (or after Factory Reset) the display will show "Setup wizard" and "YES" will be highlighted on the screen. Press the **Tuning Control Rotary** to start the setup wizard. The screen will ask if you wish to run the setup wizard again at the next start up. This will lead to the main menu.
4. Rotate the **Tuning Control Rotary** on the right hand side of the unit to highlight the desired clock format (either 12 or 24 hour) then press the **Tuning Control Rotary** to enter your selection. A menu allowing you to specify the auto update option for the clock will appear on the display. The default of 'Update from Network' will be the best option for most users.

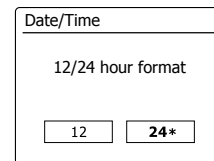
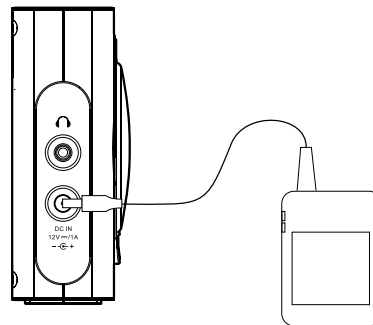

5. Rotate the **Tuning Control Rotary** to choose an auto-update option for the clock. This can be updated from DAB or FM radio, from the Network, or not updated. The default is to auto update from the network. If you choose any other option, go to step 8. Otherwise you will first need to select the correct time zone and daylight savings setting, see steps 6 and 7. If you choose "No update" you will need to set the clock manually later( see the section of 'Manually setting the clock'). Press the **Tuning Control Rotary** to confirm your choice.

6. Rotate the **Tuning Control Rotary** to highlight the time zone which is applicable to your location. Press the **Tuning Control Rotary** to enter the setting.

7. You will then need to set the Daylight Savings option according to your location (Daylight Savings is also known as Summer/Winter time ). Rotate the **Tuning Control Rotary** to highlight "YES" to turn on daylight savings if required or 'NO' if you do not wish to use daylight savings then press the **Tuning Control Rotary** to confirm the setting.

8. You will then need to set 'Keep network connected.' By default, your radio will shut down its WiFi connection when it is in standby. This minimizes power consumption but it does mean that you will need to switch that radio on manually in order to use either the 'Play to' function or any other remote control software. If you need to be able to remotely control the radio even when it has been put into standby, then rotate the **Tuning Control Rotary** to highlight 'YES' to activate this function or 'NO' to deactivate this function. you can also choose to keep the network connected by using the 'Keep connected' option in the network setting menu. In the standby mode display either the WiFi signal indicator is shown with or without a cross through it according to the chosen network settings.

9. The display will then show a list of WiFi regional options for the network set up. Rotate the **Tuning Control Rotary** to highlight the required region and then press the Tuning Control Rotary to select it. Your radio will then scan for available WiFi networks.

10. The radio will enter the Network Settings Wizard and will display 'Scanning...'. After a short while the display will show a list of the available WiFi networks.

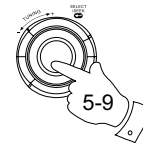

**Auto update**

Update from DAB  
Update from FM  
**Update from Network \***  
No update

**Set timezone**

**UTC+00:00: Dublin, Lon**  
UTC+00:30:  
UTC+01:00: Madrid, Arr...  
UTC+01:30:  
UTC+02:00: Athens, Ca...

**Wlan region**

**Most of Europe**

**Network settings**

Keep network connected?

**YES** **NO\***

**SSID**

Smith  
Jones  
[Rescan]  
[Manual config]

**Network settings**

Network wizard  
Scanning...

11. You will first need to identify your network in the list of network names presented by the Network Wizard. If no networks are found then you may have to get your wireless router working (please see the instructions supplied with it) or you may be too far from the router. When the radio finds your wireless network, it displays the Network Name (SSID) for the wireless access point on the screen. This is a name that is allocated to the access point in your router by the person who set up the network – for example: 'Jones family' or 'Paul's network'. If the router supports WiFi Protected Setup, then '[WPS]' will be shown in front of the SSID. It is possible, and in some locations highly likely, that your radio will find more than one wireless network, in which case you should choose which one you need to connect to.
12. Rotate the Tuning Control Rotary to see the SSID for each wireless network that has been found. If your network is shown proceed to step 14. If it is not shown then proceed to step 12. If you make a mistake at any point, use the Back button to go back to the previous screen.
13. If your network is not found, it may be because the router is configured not to broadcast the SSID. You should then use the **Tuning Control Rotary** to highlight and select the '[Manual config]' option in order to enter the network details manually. This is described in 'Manual Network Configuration'. If your network name is being broadcast, and it was not found, then try re-scanning press the Back button), and if necessary try moving your radio to a location closer to your access point / router.
14. When the SSID for the wireless network you wish to connect to is highlighted on the screen, press the **Tuning Control Rotary**. If WiFi Protected Setup (WPS) was indicated, you will see an additional menu at this point, otherwise proceed to step 14. choose one of the WPS menu options as required for your router (WPS may be via push button, or using an identification number).
  - 'Push Button' – the display prompts you to press the WPS button on your router and then the Select button on the radio. The two devices should then connect with the encryption key sent automatically to the radio.
  - 'PIN' – the display shows an identification number which you must enter into your router using a web browser (refer to your router's user documentation). You should then press the Select button on the radio.
  - 'Skip WPS' – if you wish to enter the encryption key yourself (or if it was previously Entered). If you choose Push Button or PIN the screen will then show 'Connecting...' and then 'Setup wizard completed'. Press the **Tuning Control Rotary** to exit setup wizard.

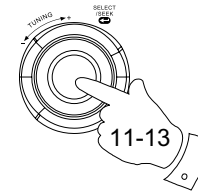

BACK

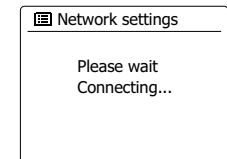
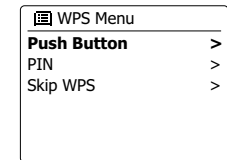
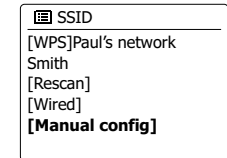
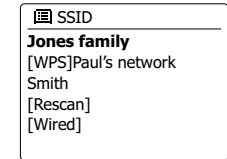

15. If your network is configured without an encryption key, the screen should say 'Connecting...', and then 'Setup wizard completed'. Press the **Tuning Control Rotary** to exit the setup wizard and show the main menu. If this is the case then you have successfully connected your radio to your network.

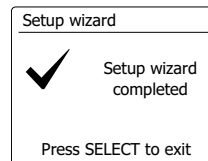

16. If the screen displays 'Key', it is because the network is using one of the encryption systems: Wired Equivalent Privacy (WEP) or WiFi Protected Access (WPA). You will need to enter the correct WEP or WPA key into the radio to allow it to communicate with your wireless network. If you do not have the WEP or WPA key, then you should obtain it from the person who set up your network. Some wireless routers may come with an encryption key already set up by the supplier, in which case you should refer to the documentation provided with it. WPA is used here to also include WPA2. WEP keys are 10 or 26 characters long (using 0 – 9, and A – F). Some wireless Routers can also use pass-phrases for WEP but these are not supported. WPA keys are usually set up using a pass-phrase of between 8 and 63 characters. Your radio accepts pass-phrases for WPA keys.

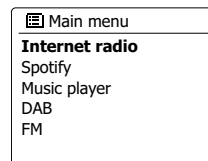

17. To enter the WEP or WPA key, characters are selected and entered using the **Tuning Control Rotary**. The highlight scrolls through the available characters as well as the three controls on the right. The character currently highlighted will be entered when you press the **Tuning Control Rotary**. Do this as needed until the complete key has been entered. Remember, WEP keys only use the numbers 0-9 and letters A-F. WPA keys are sensitive to upper and lower case characters. You must enter the key exactly or the radio will not connect to the network. The three controls on the right-hand side of the screen have special functions. You can quickly access these by pressing the **Info button** and then use the Up or Down and **Select buttons** as needed:

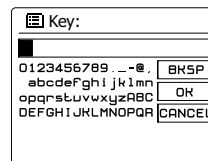

select '**BKSP**' to erase a character just entered  
select '**OK**' when the complete key has been entered  
select '**CANCEL**' to cancel an re-run the Network Wizard  
If a WEP or WPA key has previously been entered for the selected SSID then the display will show 'Key: [Set]'. If you have previously entered a different key, you must clear this by selecting the '**BKSP**' symbol. This will remove the '[Set]' indication.  
After the final character of the WEP or WPA key has been entered, highlight the '**OK**' symbol and press the **Tuning Control Rotary**. Then screen will show 'Connecting...' and then 'Setup wizard completed'. Press the **Tuning Control Rotary** to exit setup wizard. The radio should now be able to connect to the network.

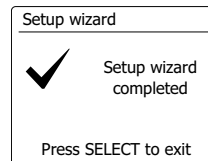
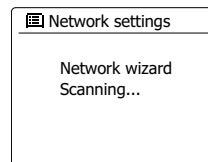

18. Once you have connected your radio to the network (and therefore also to the Internet) it will display the main menu. Press the **Tuning Control Rotary** to put the radio in Standby mode. It should then display the time as obtained from the Internet. If the time display is not correct for any reason, it can easily be adjusted later, see 'Manually setting the clock'. If you have followed the steps on the preceding pages successfully, your radio will have connected to your router, and then made a connection to the Internet and set its clock. If this is the case, then you can try listening to radio stations via the Internet.



**Note:**

To save the radio power consumption while your radio is powered with battery, the radio will turn off fully when put into standby mode. As a result, if you switch off your radio when it is power supplied with battery, next time when your radio is switched on, the time on the screen will be reset and show as '00:00'. However, as soon as the radio connects with WiFi, the time will update automatically from the network.

## Changing the network connection

In the sections above, you chose how your radio would be connected to your network, using a WiFi connection. From time to time, you may find that you need to connect to different computer networks. The Internet setup menu allows you to change your radio's network settings, scan for an alternative wireless network, or to manually configure the network parameters.

The steps outlined below describe how you can do this –see also the section 'Network Profiles'.

## Configuring the radio to use an alternative WiFi connection

From the Network settings menu select 'Network wizard'. This will present you with details of any WiFi networks that are found. Scroll down the list using the Tuning Control Rotary to the desired network name. Press **Tuning Control Rotary** to select this network. The radio will then use its WiFi system to communicate with the network. Depending on the settings for the new network you may need to enter an encryption key. By default the radio will then acquire an IP address and other network settings from your router using DHCP.

## Manual network configuration

If you do not wish to use DHCP for automatic configuration, or if your network is configured with a hidden SSID, then you will need to enter some network settings manually. (Note – a hidden SSID may prevent casual observers from detecting your network, but is not recommended as a means of network security.)

1. From the radio Network settings menu, select 'Manual settings'. You must then choose to connect using 'Wireless' connections. Entering this option, there are as many as nine settings screens, shown by the '1 of 9' progress marker in the top right corner of the display.
2. The next menu asks whether you wish to use DHCP to configure your network parameters (IP address, subnet mask, gateway address, etc). Unless you are familiar with networking and related terminology, we recommend that you allow the use of DHCP. Choose 'DHCP enable' unless you need to specify the network details manually.  
If you chose 'DHCP enable', please skip to step 6 in order to set up the wireless connection details.  
If you chose 'DHCP disable' for either connection method, the next step is to set up the IP address.

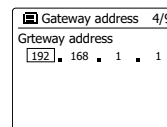
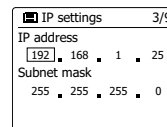
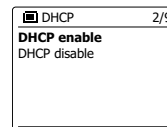
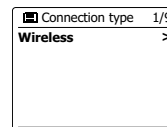
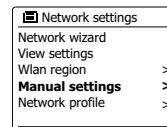
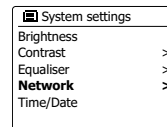
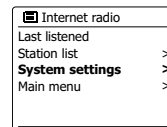

3. The manually specified IP address should be chosen to be compatible with the settings in your router and must be a unique address on your network. If you are using DHCP for some devices and static (manually configured) IP addresses for others, the IP address used should fall outside the range that the router may allocate using DHCP. Typically, the first three groups of digits will be the same for all devices on your network. To enter the IP address, rotate the Tuning Control Rotary to set the value for each group of digits and then press the **Tuning Control Rotary** to enter the value and to move on to the next group. When the IP address has been entered, the subnet mask should be entered. The subnet mask defines which parts of the IP address are common across your network. For most small networks the subnet mask will be 255.255.255.0 and this is entered in the same way.

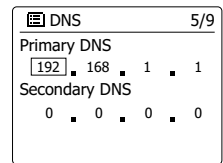

4. The Gateway address is normally the IP address of the router through which the radio connects to the internet and is entered in the same way as the previous addresses.

5. In most installations the DNS settings (DNS = Domain Name Server) will be set to the same IP address as your router. In this case the secondary DNS may be left at zero. To enter the DNS address, rotate the **Tuning Control Rotary** to set the value for each group of digits and then press the **Tuning Control Rotary** to enter the value and to move on to the next group. Repeat this until all eight groups of digits have been entered.

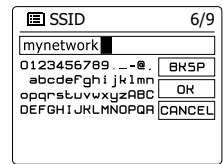

6. The next step is to set up the WiFi connection, starting with the name of the wireless network (SSID) followed by the encryption options and password. To enter the SSID, characters are selected and entered using the Tuning Control Rotary. The radio scrolls through the available characters as well as the three controls on the right. The character currently highlighted will be entered when you press the **Tuning Control Rotary**. Do this as needed until the complete network name has been entered. The SSID setting is sensitive to upper and lower case characters and symbols.

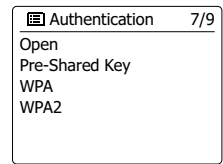

You must enter it exactly as set up in your router. The three controls on the right-hand side of the screen have special functions:

- select 'BNSP' to erase a character just entered
- select 'OK' when the complete SSID has been entered
- select 'CANCEL' to cancel and go back to the DNS settings screen

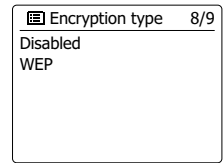

7. Having entered the SSID, you must enter details of the encryption system used on your wireless network. This should be the same as specified in your router settings. If your network does not use encryption, then select the 'Open' option. Your radio should then connect to the network, so skip to step 11. If your network uses WEP (Wired Equivalent Privacy) select the 'Pre-Shared Key' option then go to step 8. The remaining options are for WPA or WPA2 (WiFi Protected Access) – see step 9.

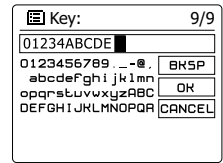

8. If you chose 'Pre-Shared Key' in step 7, you should then choose the WEP option. The key should be entered using only the numbers 0-9 and the letters A-F. The key will be 10 characters long for 64-bit encryption and 26 characters long for 128-bit encryption. The radio will accept lower-case letters a-f as equivalent to upper-case A-F. Spaces or special symbols are not permitted in WEP keys.

The three controls on the right-hand side of the screen have special functions: select '[BkSP]' to erase a character just entered (long press to clear); Info again to continue select '[OK]' when the complete encryption key has been entered select '[CANCEL]' to cancel and go back to the SSID settings screen Once the key is entered the radio should connect to your network. Please skip to step 11.

9. WPA and WPA2 are similar, although WPA2 offers a higher level of security. Whichever you selected in step 7, you then have to specify the variant used. They are TKIP (Temporal Key Integrity Protocol) and AES (Advanced Encryption Standard). As previously, the setting should match that used by your router. Some routers allow both to be specified, and the router will use whichever variant is supported by the connected device. AES is regarded as the more secure option if it is available.

10. The radio will then require you to enter the encryption key. This must be a string of between 8 and 63 characters and must be identical to the key which has been entered into your router. Note – the encryption key is sensitive to the use of upper and lower case letters and symbols. Take care to enter the key exactly, or the radio will not be able to connect to your router. The three controls on the right-hand side of the screen have special functions. You can access these by rotating the **Tuning Control Rotary** and then press the **Tuning Control Rotary** to select as you needed:

select '[BkSP]' to erase a character just entered (long press to clear); Info again to continue select '[OK]' when the complete encryption key has been entered select '[CANCEL]' to cancel and go back to the TKIP / AES options screen Once the key is entered the radio should connect to the network.

11. While the radio is trying to connect to the network, it will display 'Processing...' when checking the encryption key and then 'Connecting...'. If the connection is made successfully, the radio will return to the Network settings menu. If the unit cannot connect, then it will display a 'Failed to connect' message and will return to the SSID entry screen (step 6). Once connected, the network settings are stored in the radio. The settings are retained when the radio is disconnected from the mains. You may now use the Back and Mode buttons to access the functions of your radio.

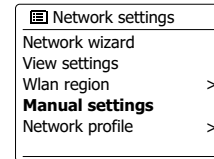
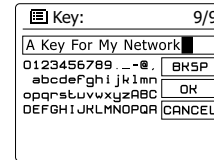
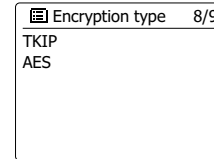
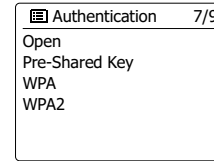



## Network remote control options

### Network Pin setup (Pin number)

Your radio has the option of being controlled by an application installed on an Apple iPhone, iPod touch or iPod. The Pin number facility allows you to ensure that your radio can only be controlled by your own Apple device rather than someone else's.

Details of how this feature can be used with your iPhone or iPod touch are explained in a separate sheet called 'The App for controlling your Sangean internet radio'.

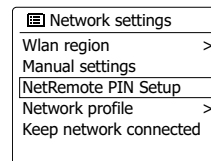

## Internet Radio

### Internet Radio – the basics

Before you can use your radio to listen to broadcasts via the Internet, it is necessary to have connected it to your computer network using the wireless (WiFi) connection.

There are literally many thousands of radio broadcasts available via the internet as well 'Podcasts'. Your radio provides several ways of searching for broadcasts in order to make finding and choosing them easier. Once you have found radio stations which you like, you may either store them as presets within the radio, or add them to a list of your favorite stations which your radio can access. The number of presets is limited (there are five presets in the radio), but you can store as many favorites as you like.

You may search for an internet radio station by Location. If you know the name of the station and the country from which a station is broadcast this may be the easiest method to find a station. It is also a great way to experience radio from other parts of the world.

You may also search for an internet radio station by Genre. If you prefer a particular type of music, Blues for example, you may search for a radio station that broadcasts that type of music, and you can choose from a list of Blues radio stations regardless of location, or taking location into account.

If you know part of the name of an internet radio station, you can enter it into the radio and it will search for stations that match that name. This can be helpful if you are unsure of the location or genre of a particular station.

The WFR-27C radio connects to a radio station database which serves many users in many countries. This means that there is a very wide range of program content available. You can also search for stations which have been recently added to those available (new stations) or you can search for the most popular.

## Selecting a radio station by location

1. Press the Standby button to switch the radio on. Then press the **Mode** button and rotate the **Tuning Control Rotary** to highlight the internet radio mode display. Press the **Tuning Control Rotary** to select the option.
2. Press the **Menu** button to enter the main Internet radio menu. Rotate the **Tuning Control Rotary** until 'Station list' is highlighted on the display and then press the **Tuning Control Rotary** to select the option.
3. Rotate the **Tuning Control Rotary** until 'Stations' is highlighted on the display and then press the **Tuning Control Rotary**. Note that the menu may offer one or more local selections based upon the country in which the unit is being used, according to your internet IP address ('United Kingdom' and 'BBC' stations, for example).
4. Rotate the **Tuning Control Rotary** until 'Location' is highlighted on the display and then press the **Tuning Control Rotary** to select.
5. Rotate the **Tuning Control Rotary** to scroll through the list of continents. When the desired continent is highlighted press the **Tuning Control Rotary** to enter your selection.
6. The display will show a list of countries within the chosen continent. If there are many countries shown you can scroll through the list continually in either direction. For example, if the chosen continent was Europe, then to find the United Kingdom scroll up from the top of the list to the bottom by rotating the **Tuning Control Rotary**. Press the **Tuning Control Rotary** to choose the desired country.
7. You will typically find that you then have the option to select either 'All Stations' or one of a number of categories. The lists are always sorted alphabetically, and long lists will wrap around from top to bottom or bottom to top.

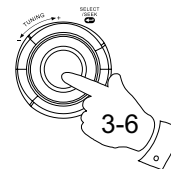
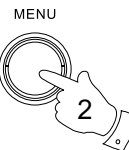
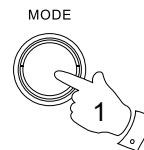

Internet radio
Last listened
<b>Station list</b>
System settings
Main menu

Internet radio
My Favourites
Local United Kingdom
BBC
<b>Stations</b>
Podcasts

Stations
<b>Location</b>
Genre
Search stations
Popular stations
New stations

Location
Africa
Asia
Caribbean
Central America
<b>Europe</b>

Europes
Switzerland
Turkey
Ukraine
<b>United Kingdom</b>
Vatican

United Kingdom
<b>All stations</b>
Highlighted stations
Alternative
Ambient
Celtic

All Stations
Asian sound radio
Aston FM
Atlantic FM
Audio Book Radio
<b>BBC Radio 1</b>

8. Rotate the **Tuning Control Rotary** to highlight your chosen radio station and then press the **Tuning Control Rotary** to enter your selection. The display will show 'Connecting...' while the radio connects to the new station. The station should then start playing. Adjust the volume as needed.

9. If the station has on-demand content, that is, it gives the option of listening to programs which have already been broadcast or to Podcasts, there will be an additional screen showing the radio station name as well as a 'Podcasts' option. These are selected using additional menus, determined by the radio station and the content. There may simply be a list of programs, or there may also be options to choose from broadcasts on particular dates or days of the week. The examples shown here are typical. Podcasts and Listen Again content can also be accessed separately from the main Internet Radio menu.

## If your radio cannot connect to a radio station

### Note:

If your radio is unable to connect to an internet radio station it will generally either display 'Network Error' or 'Stopped'. This can be for many reasons, but typically will be due to one of the following:

- The radio station may not be broadcasting at the present time.
- The radio station may not be able to accommodate any more connections from internet listeners.
- The broadcaster may limit listening to specific countries or regions.
- There may be network congestion (either locally or at a distance) which is affecting the reliability of the connection.

If your radio can connect, but the audio is not continuous and the radio keeps having to reconnect, this may be due to the radio station only having limited connection capacity.

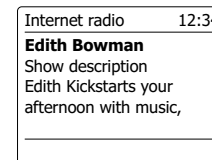
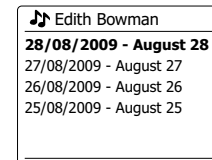
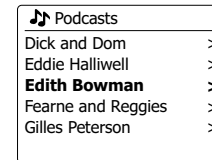

## Selecting a radio station by genre

1. Press the **Menu** button to enter the main Internet radio menu.
2. Rotate the **Tuning Control Rotary** until 'Stations' is highlighted on the display and then press the **Tuning Control Rotary** to select.
3. Rotate the **Tuning Control Rotary** until 'Genre' is highlighted on the display and then press the **Tuning Control Rotary**.
4. Rotate the **Tuning Control Rotary** to scroll through the list of content types. This menu is normally cyclic – you can scroll the list continually in either direction. When the chosen genre is highlighted, press the **Tuning Control Rotary**.
5. You then have the choice of 'All Stations' of the chosen genre, or a list of countries. Note if a country is not shown then the station may still appear in the 'All Stations' list. Rotate the **Tuning Control Rotary** and the **Tuning Control Rotary** to choose as needed.
6. A list of radio stations is then shown. Rotate the **Tuning Control Rotary** until the desired station name is highlighted on the display.
7. Press the **Tuning Control Rotary** to select the station. The display will show 'Connecting...' while it finds the new station. If the radio is unable to connect this may be for one of the reasons explained previously.
8. Adjust the Volume as needed to set the listening level.

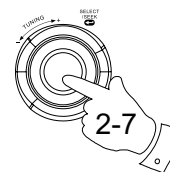
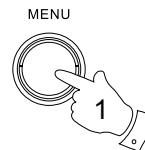

Internet radio	
My Favourites	>
Local United Kingdom	>
BBC	>
<b>Stations</b>	>
Podcasts	>

Stations	
Location	>
<b>Genre</b>	>
Search stations	
Popular stations	>
New stations	>

Genre	
Alternative	>
Ambient	>
Big Band	>
Bluegrass	>
<b>Blues</b>	>

Blues	
<b>All Stations</b>	>
Highlighted Stations	>
Belgium	>
France	>
Germany	>

All Stations	
Asian sound radio	
Aston FM	
Atlantic FM	
Audio Book Radio	
<b>BBC Radio 1</b>	

## Searching for a radio station by name

There may be occasions when you know the name of a radio station but you do not know the location or genre. This facility allows you to search for the station using a part (or parts) of the radio station name.

1. Press the **Menu** button to enter the main Internet radio menu. Rotate the **Tuning Control Rotary** until 'Station list' is highlighted on the display and then press the **Tuning Control Rotary**.
2. Rotate the **Tuning Control Rotary** until 'Stations' is highlighted on the display and then press the **Tuning Control Rotary**.
3. Rotate the **Tuning Control Rotary** until 'Search stations' is highlighted on the display and then press the **Tuning Control Rotary**.
4. To enter the search word(s) press the **Tuning Control Rotary** on the remote control to highlight each character for the search in turn, and press the **Tuning Control Rotary** to enter. If you make an error press the **Info** button to access the delete character 'BKSP' on the screen and the character selection. After the final character of the search has been entered, use the **Info** button and then the **Tuning Control Rotary** to highlight the 'OK' symbol on the screen and then press the **Tuning Control Rotary** to finish.
5. The radio will search for radio stations that match your search data. If you include a space between two search items the radio will look for station names which include both items. Thus a search for 'ROCK 100' could find a station called '100 Classic Rock Hits' as well as a station called '100.FM Rocks'.
6. Rotate the **Tuning Control Rotary** to highlight the station that you wish to listen to and press the **Tuning Control Rotary** to confirm your choice. The display will show 'Connecting...' while it finds a new station.

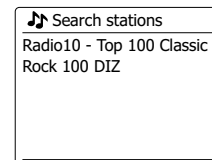
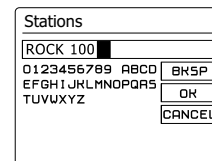
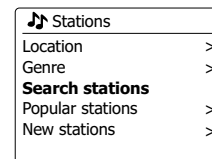
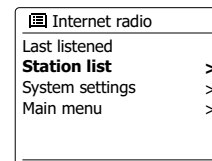
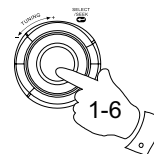
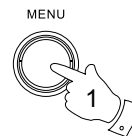

## Selecting a new or popular station

As described in the section 'Internet Radio – the basics', your radio connects via the the Internet to a database of radio stations. This option is provided to highlight stations which are newly added to the list of those available, or stations which are particularly popular with listeners around the world. Your radio allows you to easily choose stations from these two categories, using menus very similar to those used when finding stations by location and genre.

1. Press the **Menu** button to enter the main Internet radio menu. Rotate the **Tuning Control Rotary** until 'Station list' is highlighted on the display and then press the **Tuning Control Rotary**.
2. Rotate the **Tuning Control Rotary** until 'Stations' is highlighted on the display and then press the **Tuning Control Rotary**.
3. Rotate the **Tuning Control Rotary** until 'Popular stations' or 'New stations' is highlighted on the display. Press the **Tuning Control Rotary** to enter your choice.
4. Rotate the **Tuning Control Rotary** to highlight the station that you wish to listen to and then press the **Tuning Control Rotary** to enter your choice. The display will show 'Connecting...' while the new station is found.

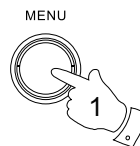

Internet radio	
Last listened	
<b>Station list</b>	>
System settings	>
Main menu	>

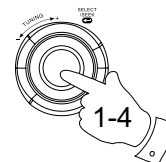

Internet radio	
My Favourites	>
Local United Kingdom	>
BBC	>
<b>Stations</b>	>
Podcasts	>

Stations	
Location	>
Genre	>
Search stations	>
<b>Popular stations</b>	>
New stations	>

Stations	
<b>BBC Radio 4</b>	
ENERGY ZURICH	
All Irish Radio	
Classic FM	
RTL 2	

## Selecting a podcast / BBC Listen Again

Some radio stations allow you to listen to programs that have already been broadcast. The BBC's Listen Again service is an example of this. In addition, radio broadcasters and individuals may make programs which are intended normally to be downloaded into a computer or copied onto a portable media player. These are commonly known as Podcasts.

On your radio, both Listen Again programs and Podcasts are grouped together as Podcasts, and the same menu is used to access and listen to both types of programming. Listen Again programs are also accessible via the Stations menu.

1. Press the **Menu** button to enter the main Internet radio menu. Rotate the **Tuning Control Rotary** until 'Station list' is highlighted on the display and then press the **Tuning Control Rotary**.
2. Rotate the **Tuning Control Rotary** until 'Podcasts' is highlighted on the display and press the **Tuning Control Rotary**.
3. You may then search by location, genre, or using part of the name of the podcast. The searches operate in exactly the same way as when searching for a conventional radio station. Searching by location is done first by continent, then by country. You may then list 'All shows' or search within a country by genre. Searching by genre is more direct, since once the genre is chosen the next menu display shows a list of available podcasts. Searching by name operates in the same way as when searching for a named radio station, selecting the '[OK]' symbol when you have entered the text. You may enter one or more pieces of text which will be used for the search.
4. Rotate the **Tuning Control Rotary** and then press the **Tuning Control Rotary** to confirm your chosen podcast. The display will show 'Connecting...' while it finds the new program.

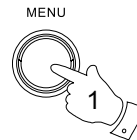

Internet radio	
Last listened	
<b>Station list</b>	>
System settings	>
Main menu	>

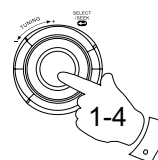

Internet radio	
My Favourites	>
Local United Kingdom	>
BBC	>
Stations	>
<b>Podcasts</b>	>

Stations	
<b>Location</b>	>
Genre	>
Search stations	

Podcasts	
0123456789 ABCD	BRSP
EFGHIJLKNOPQRS	OR
TUVWXYZ	CANCEL

Podcasts	
Dick and Dom	>
Eddie Halliwell	>
<b>Edith Bowman</b>	>
Fearne and Reggies	>
Gilles Peterson	>



## Presetting stations

With so many Internet radio stations available, it is desirable to have a means of rapidly selecting the stations that you listen to most frequently. Your radio has five memory presets which can easily be set to store the details of any Internet radio station. The radio station presets are retained in memory even when the radio is switched off. Please see also the section 'Last Listened' and 'Configuring My Favorite Stations'.

### Storing a preset

1. Press the **Standby** button to switch on your radio. Tune to the required station using one of the methods described on the preceding pages.
2. To store the currently playing radio station as a preset, press and hold the required **Preset** button (1 – 5) on the panel until the display shows 'Preset stored'. The station will be stored using the chosen preset button. Repeat this procedure as needed for the remaining presets.
3. Stations which are already stored in the presets may be over-written by following the above procedure.

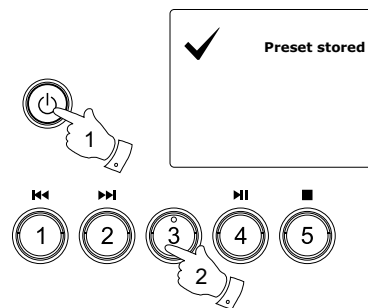

### Recalling a preset

1. Press the **Standby** button to switch on your radio. Select the Internet radio mode using the Mode button.
2. Momentarily press the required **Preset** button on the remote control. Your radio will then connect to the station stored in preset memory. The preset used will be shown at the bottom of the display screen.

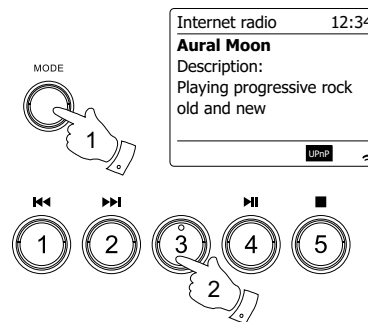

## Last Listened

It is often helpful to be able to go back to a station that you have already listened to. Your radio has a 'Last Listened' feature which provides you with quick access to the ten most recently listened to radio stations or podcasts. As each new radio station is listened to the oldest item is deleted from the list. The Last Listened list is stored when the radio is disconnected from the mains.

1. With the radio switched on and in Internet radio mode, press the **Menu** button. The first item on the menu is 'Last listened'. With this item highlighted press the **Tuning Control Rotary**.
2. The display will then show a list of the last ten Internet radio stations or podcasts. Rotate the **Tuning Control Rotary** to highlight whichever you wish to listen to and then press the **Tuning Control Rotary** to cause your radio to reconnect to that radio station or podcast.

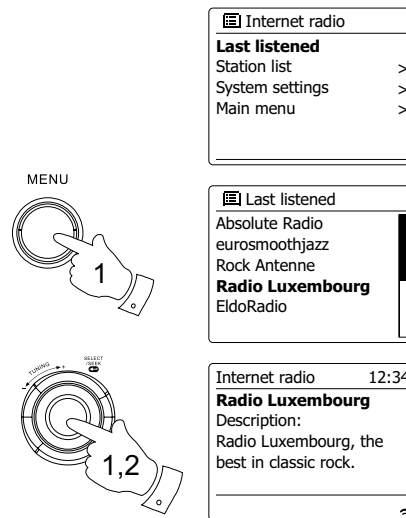

## Display modes

Your radio has a range of display options when in Internet Radio mode. Note that not all information may be available for all Internet radio stations.

1. Press the **Info** button to cycle through the different options.

- a. Description      Displays information about the radio station or scrolling text messages such as artist/track name, phone number etc.
- b. Genre            Displays program type information e.g. Pop, Classic, News, etc. and the location of the current radio station.
- c. Reliability       Displays the reliability of the data stream from the station currently being received.
- d. Format            Displays the bit rate and format of the station being received.
- e. Playback buffer   Displays status when connecting to and playing a radio station. This indicates the reliability of the data stream to your radio. If there are no bars shown to the right of the dividing line then the data stream reliability may be poor and you may find that there are many breaks in the audio (this is not always the case for REAL audio streams).
- f . Date             Displays the current date.

Additional or alternative information may be displayed when listening to Podcasts, Categories displayable can include...

Episode name	Show description
Show genre	Show language
Episode URL	Bit rate
Codec	Sampling rate

Whenever the radio is displaying an information screen (as opposed to a menu screen), the time is displayed in the top-right corner of the display, and a WiFi strength indicator is shown in the bottom-right corner.

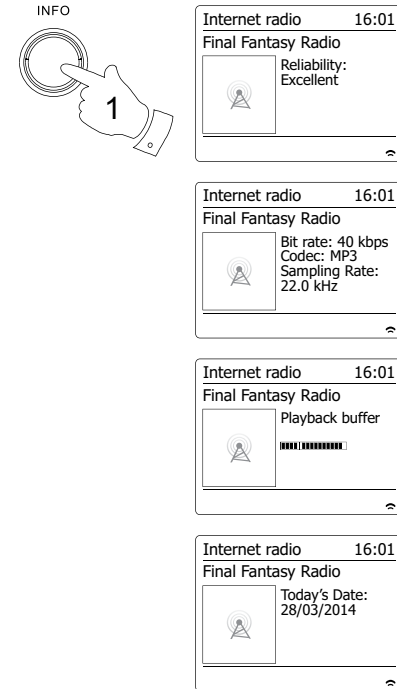

## Customizing your radio

In addition to storing your favourite radio stations in the radio presets, your radio allows you to create customised lists of stations which can appear in two special menus on the radio called 'My Favourites' and 'My Added Stations'. Your radio uses a database which is accessed via the Internet in order to find out which radio stations are available and how it should connect to them. You are able to add your personal selections to this database. These will only be accessible by you using your PC or your radio. You can choose the stations which will appear in the 'My Favourites' menu from the large selection already listed. Additionally, if you find a radio station that is not listed then you may also add the Internet address (URL) of the station's audio stream to your selection. It will then appear on your radio via the 'My Added Stations' menu item.

## Registering an account

1. Open the web site <http://www.wifiradio-frontier.com> using the Internet browser on your computer. Click on the 'Register here' link and follow the on-screen instructions to register an account. During the registration process the web site asks for an access code. This allows it to uniquely identify your internet radio from the many others that it also provides data for. To obtain the access code, please follow these steps.
2. With your radio switched on and in Internet radio mode, press the **Menu** button, then select 'Station list' using the **Tuning Control Rotary**.
3. Scroll down the Station list menu to the item called 'Help'. Press the **Tuning Control Rotary** to enter the Help menu.
4. In the Help menu, select the menu item 'Get access code.' Provided that the radio is connected to the Internet, a code will be displayed of typically seven characters (Upper case letters and numbers). Make a note of this code for the next step. If you need to re-register later you must repeat this process to get a fresh access code.
5. You should then use the code displayed by the radio to fill in the Access Code field on the web page when you set up your account. Once you have your account set up, if you have other radios which use the same data base, you may also add them to your account. You will need to get an access code from each radio in order to add it to the account. They may then share your favorite and added radio station details.

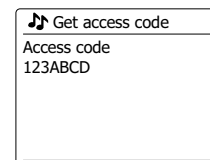
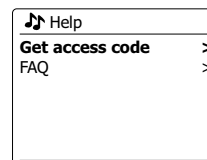
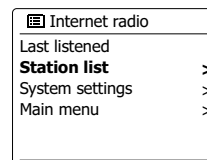

## Configuring My Favorite Stations

1. Using the website at <http://www.wifiradio-frontier.com> it is possible to search among the many radio stations that are available by location, genre, or language. You may also choose from new or popular stations.
2. When the radio stations that you have found are shown on your computer screen, they are shown with a 'Play' icon and an 'Add to favourites' icon (the plus symbol and heart). Clicking on the 'Play' icon will allow you to hear the radio station via your computer. Clicking on the 'Add to favourites' icon will cause the radio station to be added to the list accessible via your radio.
3. To help you organise your favourites, and since you may have a many after a while, the website will allow you to specify the name for a category or group under which the radio station will be listed on your radio. Suitable names might be 'Rock', 'Smooth', 'Mum's stations', and so on. Whenever you add another radio station to your favourites you can either add it to an existing.
4. Once you have Internet radio stations available in your 'My Favorite Stations' list, you may play these stations from your radio. These stations will be available on your radio from the Internet radio menu item 'My Favourites'.
5. To look at, modify or delete your favourite stations lists on the website, use the link 'My favourites' in the 'My account' area. To delete a favourite radio station, click on the icon with a heart and minus symbol.

## Configuring My Added Stations

1. If you wish to listen to a radio which is not a currently held in the database at <http://www.wifiradio-frontier.com>, it is possible to add the details yourself. You will need to obtain the internet address (URL) for the audio system for the station that you wish to add. This may be information provided by the radio station itself, via its website, or perhaps passed to you from another listener.
2. Use the 'My added stations' link in the 'My account' area on the website. This allows you to add details of new stations or to modify those already added. You can provide a name for the radio station which will be shown on your radio. You must also provide the web address, location and format details.
3. Once you have Internet radio stations available in your 'My Added Stations' list, you may play these stations from your radio. These will be available on your radio from the Internet radio menu item called 'My added Stations.'
4. It is possible to add the web addresses for audio streams which may not be playable by your radio. If you attempt to play such a stream, your radio will normally display an error message of some kind. The Sangean WFR-27C can only play MP3, WMA, AAC and Real Audio internet radio streams.
5. To look at, modify or delete your added stations list on the website, use the link 'My added stations' in the 'My account' area. To delete an added radio station, click on the icon with a heart and minus symbol.

## Selecting your favorite stations

1. Press the **Menu** button to enter the main Internet radio menu.
2. Press the **Tuning Control Rotary** until 'Station list' is highlighted on the display. Press the **Tuning Control Rotary** to enter the menu.
3. Rotate the **Tuning Control Rotary** until 'My Favourites' is highlighted on the display. Press the **Tuning Control Rotary** and your favorite stations list will appear on the display (set up as described on the preceding page).
4. Press the **Tuning Control Rotary** to highlight the required station and then press **Tuning Control Rotary** to confirm your selection. The display will show 'Connecting...' while it finds the new station. If the station has on-demand content (that is, it gives the option of listening to programs which have already been broadcast), 'Selecting a podcast / BBC Listen again'. Should you be unable to connect to a particular station, please note that some radio stations do not broadcast 24 hours per day, and some stations are not always on-line.

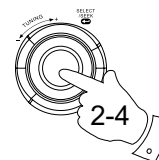
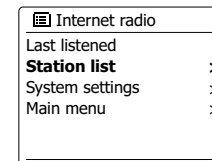
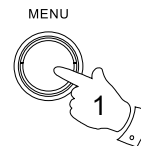

## Selecting your added stations

1. Press the **Menu** button to enter the main Internet radio menu. Rotate the **Tuning Control Rotary** until 'Station list' is highlighted on the display and then press the **Tuning Control Rotary** to select.
2. Rotate the **Tuning Control Rotary** until 'My Added Stations' is highlighted on the display and then press the **Tuning Control Rotary** to select.
3. Rotate the **Tuning Control Rotary** to highlight the required station and then press the **Tuning Control Rotary** to confirm your selection. The display will show 'Connecting...' while it finds the new station. Should you be unable to connect to a particular station, please note that some radio stations do not broadcast 24 hours per day, and some stations are not always on-line. In addition, as mentioned in the previous section, it is possible to specify audio streams for 'My added stations' which are not compatible with your radio. In this event the station will not be playable. The Sangean WFR-27C can only play MP3, WMA, AAC and Real Audio internet radio streams.

Note that the audio coding formats listed are generic terms. There are many variations of each format, as well a variety of streaming protocols in use by different radio broadcasters. Your radio has been designed to play the vast majority of coding and streaming formats in current use by broadcasters.

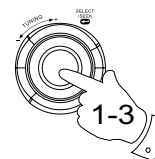
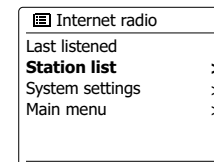
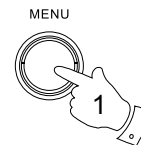

## Music player

### Use with Windows, Apple Mac and Linux

The Music Player allows you to play audio files which are stored on computer in your network.

In order to play files from a computer on your network, your radio must connect to a file server application which uses the Universal Plug and Play (UPnP) protocol. If your computer uses Windows 7, Vista or XP, then it is likely that your computer already has a UPnP server application available. Windows Media Player (versions 11 and 12) has this capability, and it is able to make your files available to your radio. It also allows you to select files by Album, Artist, and so on.

Windows Media Player 12 can serve MP3, WMA, AAC and WAV files to your radio. Windows Media Player 11 is only able to serve MP3 and WMA files to your radio. If you are an Apple Mac or Linux user, there are other UPnP server applications which you may use with your radio.

The Music Player on the radio can playback audio files in MP3, WMA, AAC and WAV formats. WMA Lossless files can also be played when using Windows Media Player as it will convert these to a compatible format before streaming them to the radio. Note that the playback of files encoded using WMA Voice, WMA 10 Professional, and for files which have DRM protection are not supported.

When using a UPnP server, the search and selection criteria are determined by the server software, but typically include Artist, Album and Genre. Many server applications also allow you to access your files according to the folders within which they are stored as well as other criteria.

Windows Media Player is less flexible than some other UPnP servers, but is generally easier to set up. It is supplied as a standard component of windows 7, Vista or XP.

Many UPnP server applications are also capable of sharing pictures and video files to other network connected devices. If this is the case (as it is with Windows Media Player 11 and 12) you may see the option of choosing between 'Music', 'Video' and 'Pictures' on the Music Player's Menu. You should only select the 'Music' option. Content offered via the alternative options will not be playable on your radio.

Some third part server application allow customization of the search criteria and indexing methods. This can be useful if you have a very large collection of store music files.

Here is a short selection of alternative UPnP server applications, although many other are available.

Twonky Media Server (Windows, Apple Mac, Linux)  
TVersity (Windows)  
Elgato EyeConnect (for Apple Mac OS X)  
Media Tomb (Linux, MAC OS X)

Please refer to the documentation for your chosen server application for full details of its configuration and usage.



## Accessing your audio files via a UPnP server

If your computer is running Windows 7, then Windows Media Player version 12 includes a UPnP server which will make your files available to your radio.

If you have Windows Vista or XP (Please refer to the section of 'Accessing your audio files via a UPnP server using Windows Vista and XP'). There are other UPnP server solutions available for non-Windows users and for Windows users who may wish to use an alternative (see the preceding section). It is beyond the scope of this instruction book to cover all possible options for UPnP. We explain the use of Microsoft's Windows Media Player here since that will be the first choice for the majority of users.

### Set up UPnP access with Windows Media Player 12

1. Windows Media Player 12 (referred to here as WMP 12) can create a library from all the media files available on your PC. To add new media files to the library, select 'Library', then 'Music', then 'All music' or 'Artist', 'Album' etc. This will show you the current library contents. You may then simply drag and drop files from other locations into the library. Alternatively, with media files or folders on the screen, you may right-click on the file or folder and select 'Include in library' and then select 'Music'. In this way you can quickly add additional content to your music library.
2. In WMP 12, click on 'Stream' (see picture at right) and then select 'Automatically allow devices to play my media'. Then accept the 'Automatically allow all computer and media devices' option. There are other options (see overleaf) but this is the simplest if you just wish to quickly enable media streaming to your radio.
3. Press the Standby button to switch the unit on. Then press the **Mode** button and rotate the **Tuning Control Rotary** as needed until the Music Player mode display is shown. Then press the **Tuning Control Rotary**. The main 'Music Player' menu will then be displayed.

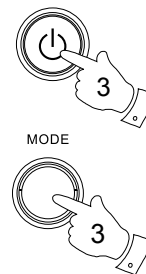
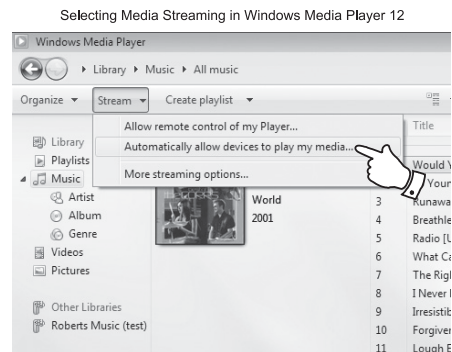

MODE

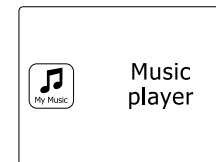

4. Rotate the **Tuning Control Rotary** until 'Shared media' is highlighted and press the **Tuning Control Rotary** to select. The radio will scan for all available UPnP servers. It may take a few seconds for the radio to complete its scan. The radio will display '<Empty>' if no UPnP servers are found.

5. After scanning, select your UPnP server using the **Tuning Control Rotary** on the panel. If you allowed automatic connection previously, your radio should now connect and you may skip to the next page. If you did not permit automatic connections, your radio will then normally display 'Unauthorized' at this stage.

6. Your PC may prompt you that there has been a connection to your UPnP server. Whether prompted or not, in order that the radio may access the music files, you will need to click the 'Library' tab in WMP 12 and select the 'Stream...' item to open the 'Media Streaming' window. Select 'Automatically allow devices to play my media' then select 'Automatically allow all computer and media devices'. Alternatively select 'More Streaming options' to enable sharing on a 'per device' basis.

7. In the 'More streaming options' window, the radio will be listed as a blocked device. Click on the button shown to select 'Allowed'.

**Note:**

If you are using Microsoft Windows' firewall software, this should be correctly configured by WMP 12. If you are using third party firewall software you may need to manually configure it to allow your unit and WMP 12 to communicate.

8. On the radio, select the **named server** again using the **Tuning Control Rotary**. If WMP 12 is now able to communicate with your radio you will be presented with some media selection options on the display.

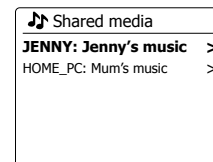
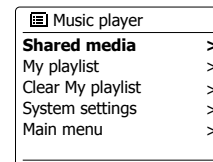
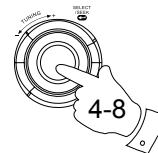

## Locating and playing media files using UPnP

Once the UPnP server has been configured to share media files with your radio, you may select the files that you wish to play as follows:-

1. Press the Standby button to switch on the unit. Press the **Mode** button and rotate the **Tuning Control Rotary** as needed until the Music Player mode display is shown. Then press the **Tuning Control Rotary**. The main Music Player menu will then be displayed.
2. Rotate the **Tuning Control Rotary** until 'Shared media' is highlighted on the display and then press the **Tuning Control Rotary** to cause the radio to scan for UPnP servers. Note that it may take a few seconds for the radio to complete its scan. The display will return to the Music Player menu if no UPnP servers are found.
3. After a successful scan, rotate the **Tuning Control Rotary** to highlight your UPnP server and then press the **Tuning Control Rotary**. If the display shows multiple media types, select 'Music'. (Some UPnP servers can serve pictures and video content to suitable devices.)
4. The radio will now list the media categories which are made available by the UPnP server - for example, 'Album', 'Artist' and 'Genre'. Rotate the **Tuning Control Rotary** to highlight which category you wish to browse, then press the **Tuning Control Rotary** to confirm your choice.

If you wish to use the search function rotate the **Tuning Control Rotary** until 'Search' is selected on the display. You may select characters to build a keyword for searching for content to play.

When you first set up sharing with a UPnP server, not all of your files will be available immediately. The UPnP server must look inside each file to identify the artist and album information from 'tags' embedded in them.

The server may also need time to access the Internet to obtain additional information such as 'album art' which it can display when you examine your music library on your PC. For a library of many files this can take some time.

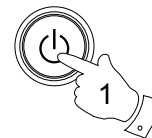

MODE

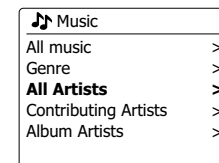
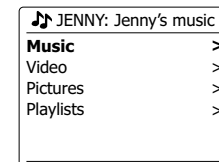
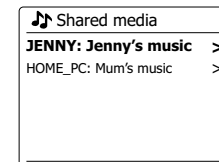
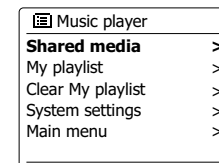
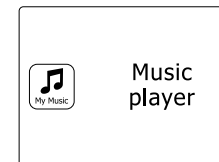
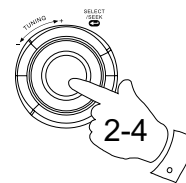
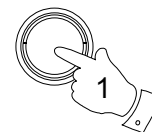

GB

## Media selection

When searching via UPnP you will have a selection of search criteria as determined by the UPnP server software on your computer. This allows you to search by a given information type (Album, Artist, Genre, etc.) and then to narrow the search to an album or to a particular track within an album. Some UPnP server applications allow the search options to be customized. The searches described here are just examples of the possibilities.

## Listening to a complete album

1. Rotate the **Tuning Control Rotary** to choose content by Artist, Album, Genre, etc. according to your needs then press the **Tuning Control Rotary** to enter your choice.
2. When you reach the album or folder the menu will then switch to showing the tracks in that album or folder. When searching by UPnP they will normally be listed in track number order (but as with the search criteria, this can vary according to the server application used).
3. With the first track in the album indicated, press the **Tuning Control Rotary**. The album will then begin playing.

While the radio is playing from your media library, you may use the menus as described above to choose a different selection. When you select the track from which to play, the radio will then immediately begin playing the new selection.

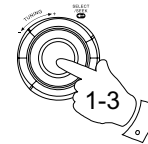

🎵 JENNY: Jenny's music	
<b>Music</b>	>
Video	>
Pictures	>
Playlists	>

🎵 Music	
All music	>
Genre	>
<b>All Artists</b>	>
Contributing Artists	>
Album Artists	>

🎵 Music	
<b>The Beatles</b>	>
Beautiful South	>
Beethoven	>
Cat Stevens	>
Cream	>

🎵 The Beatles	
<b>The Beatles - 1</b>	>
Abbey Road	>
Help!	>
Rubber Sour	>
Sgt. Peppers Lonely Hea	>

🎵 The Beatles 1	
<b>Love Me Do</b>	>
From Me to You	>
She Loves You	>
I Want to Hold Your Han	>
Can't Buy Me Love	>

## Listening to a particular track

1. If you wish to play only a particular track from an album or folder, first choose the album or folder as described on the preceding pages.
2. Rotate the **Tuning Control Rotary** until the required track is highlighted.
3. Press and release the **Tuning Control Rotary**. The track will begin playing. The radio will then play subsequent tracks from the same album or folder.

## Controlling playback

1. Press the **Play/Pause** button to pause playback of the current track.
2. If you press the **Play/Pause** button, playback will resume from the point where it was paused.
3. Press the **Rewind** button to start playback of the previous track in the list.
4. Press the **Fast-forward** button to start playback of the next track in the list.
5. Press and hold the **Fast-forward** or **Rewind** button to move through the current track. The longer the button is pressed, the greater the speed at which the player will move through the track. Release the button when the desired point is reached. (Note that this feature is not supported when playing files encoded using the FLAC format.)

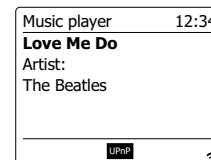
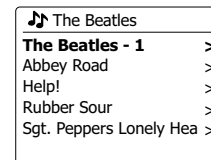

## Repeat tracks

1. When a track is playing , press the **Menu** button to enter the main Music player menu.
2. Rotate the **Tuning Control Rotary** until 'Repeat play' is highlighted on the display. Press the **Tuning Control Rotary** to turn on the repeat function. Your selected track will be played repeatedly and the repeat indicator will show on the display.
3. To turn off the repeat option, select the 'Repeat Play' again.



## Shuffle tracks

1. When a track is playing , press the **Menu** button to enter the main Music player menu. Rotate the **Tuning Control Rotary** until 'Shuffle play' is highlighted on the display. Press the Tuning Control Rotary to turn on the shuffle function. Your selected track will be shuffled and the shuffle indicator will show on the display.
2. To turn off shuffle select the 'Shuffle play' again.



If both Repeat and Shuffle playback options are activated then both Repeat and Shuffle icons will be shown in the display.

### Note:

The shuffle play function may only be used if the current selection comprises fewer than 512 tracks.

## Display modes

Your radio has a range of display options when in Music Player mode. Note that the availability of information depends on the specific media files, their format and upon the server capability. (Not all UPnP servers make information from the media files available in the same way.)

1. Press the **Info** button to cycle through the different options.

- a. Progress bar Displays the playback progress for the track currently playing.
- b. Artist Displays the artist information for the track currently playing.
- c. Album Displays the album information for the track currently playing.
- d. Format Displays the bit rate and format of the track currently playing.
- e. Buffer Displays the radios internal buffer status during media playback.

Whenever the Music Player is displaying an information screen (as opposed to a menu screen), the time is displayed in the top-right corner of the display, and a WiFi strength indicator is shown in the bottom-right corner together with an indicator showing the radio is obtaining the media from a UPnP server.

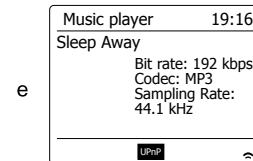
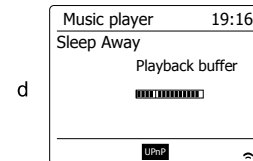
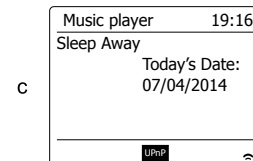
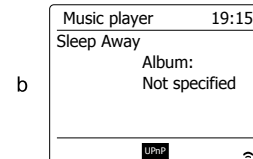
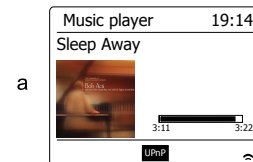
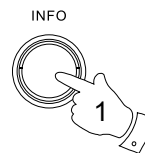

## Playlists

Sometimes you may wish to set up a list of music tracks or albums which can then be played without further action - as background music for a party, for example. Your radio can be configured to hold a queue of up to 500 tracks in a playlist menu. The tracks or albums for the playlist can be selected from your UPnP server. The playlist is held in memory in your radio until external power is removed, or until the playlist is cleared from the menu.

### Adding a single track to your playlist

1. When selecting (or when playing) a track using a UPnP server press and hold the **Tuning Control Rotary** and the display will show 'Added to My playlist'.
2. The track will be added to the playlist for playback later.

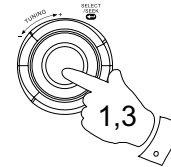

### Adding an entire album or folder

3. When using a UPnP server highlight the chosen album, artist or folder and press and hold the **Tuning Control Rotary**. The display will show 'Added to My playlist'.
4. Each of the tracks within the album, artist or folder selection will be added to the playlist individually. This allows any unwanted tracks to be removed from the playlist if needed (see the following sections).

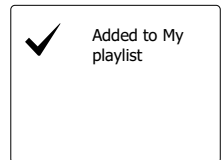
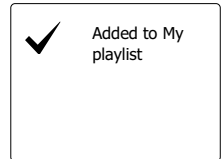



## Viewing your playlist

1. Press the Standby button to switch on the unit. Press the **Mode** button and rotate the **Tuning Control Rotary** as needed until the Music Player mode display is shown. Then press the **Tuning Control Rotary**. The Music Player menu will then be shown on the display.
2. Rotate the **Tuning Control Rotary** until 'My Playlist' is highlighted on the display. Press the **Tuning Control Rotary** button to enter the playlist.
3. Rotate the **Tuning Control Rotary** to scroll through the playlist. Tracks which are served via UPnP will show their track name.

## Erasing a track from the playlist

1. Press the **Menu** button to enter the main Music Player menu.
2. Rotate the **Tuning Control Rotary** until 'My Playlist' is highlighted on the display. Press the **Tuning Control Rotary** button to enter the playlist.
3. Rotate the **Tuning Control Rotary** until the track you wish to erase is highlighted. Press and hold the **Tuning Control Rotary**.
4. You will be asked to confirm the deletion. To delete the track rotate the **Tuning Control Rotary** buttons until 'YES' is highlighted on the display. Press the **Tuning Control Rotary** to cause the track to be deleted.
5. If you do not wish to delete the track highlight 'NO' and press the **Tuning Control Rotary** to cancel the operation.

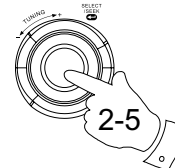
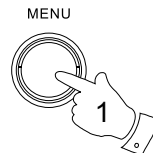
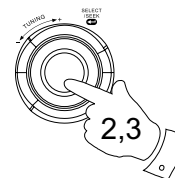
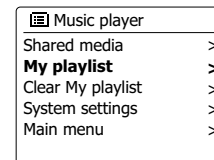
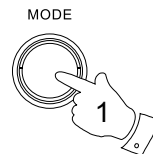

## Clearing the playlist

1. Press the **Menu** button to enter the main Music Player menu.
2. To clear the whole playlist press the **Tuning Control Rotary** until 'Clear My playlist' is highlighted on the display. Press the **Tuning Control Rotary**.
3. To clear the whole playlist rotate the **Tuning Control** until 'YES' is highlighted on the display. Press the **Tuning Control Rotary** to cause the playlist to be cleared.
4. If you do not wish to clear the playlist highlight 'NO' and press the Tuning Control Rotary to confirm.

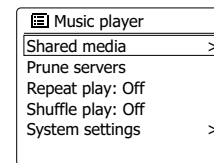
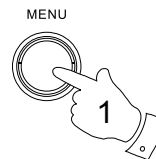

## Playing your playlists

1. Press the **Menu** button to enter the main Music Player menu.
2. Press the **Tuning Control Rotary** until 'My playlist' is highlighted on the display. Press the **Tuning Control Rotary** button.
3. To play the playlist from a particular track, rotate the **Tuning Control Rotary** until the desired track is highlighted then press the **Tuning Control Rotary** to start play.
4. While playing from the playlist, you can use this function to jump to a particular track within the playlist. While playing from the playlist, you may add additional tracks or albums or remove specific tracks (please see the preceding sections).

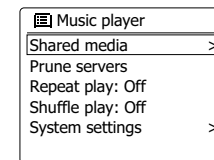
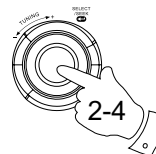

## Wake On LAN

If you use a computer as a UPnP server for playing your music files via your radio, you may not wish to keep that computer running when you are not using the radio. If your computer is suitably configured, it can either shut down, or enter a standby or hibernation state when it is not being used.

Your radio can wake up a computer which has shut down using a Wake On LAN command via the network provided that the radio has previously connected to a UPnP server application on that computer. A computer which is not currently active will be shown with a question mark in the list of UPnP servers.

Many computers will not respond to Wake On LAN commands from the radio in all modes, and may require software, device driver, BIOS, hardware or router configuration changes for this function to operate. Failure of a computer to respond to Wake On Lan is not considered a fault of the radio.

## Prune servers

Your radio stores details of the UPnP servers that it has seen via its network connection in its internal memory. If you use the radio at different locations you may find that there are servers listed by the radio that are no longer available. The prune servers functions allows the list to be reinitialized so that only active UPnP servers on the currently connected network are shown when selecting 'Shared Media' from the Music Player menu.

1. Press the **Menu** button to enter the main Music Player menu.
2. Rotate the **Tuning Control Rotary** until 'Prune servers' is highlighted on the display. Press the control.
3. To remove servers that are no longer required rotate the **Tuning Control Rotary** until 'Yes' is highlighted on the display. Press the **control** to cause the servers to be removed.
4. If you do not wish to prune servers rotate the **Tuning Control Rotary** to highlight 'No' and press the **control** to confirm.

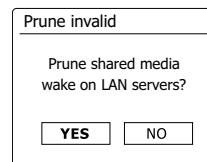
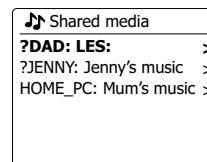

## Keep network connected

### Keep network connected

By default, your radio will shut down its WiFi connection when it is in standby. This minimizes power consumption but it does mean that you will need to switch that radio on manually in order to use either the 'Play to' function or any other remote control software.

If you need to be able to remotely control the radio even when it has been put into standby, then you can choose to keep the network connected by using the 'Keep connected' option in the network setting menu. In the standby mode display either the WiFi signal indicator is shown with or without a cross through it according to the chosen network settings.

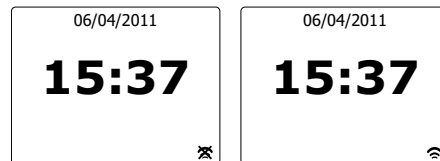

### Windows 7 'Play to' function (UPnP renderer)

If you use Windows 7, it is possible to choose a music album, track or playlist at the computer and then tell Windows that this should be played on the radio using the 'Play to' function. Using suitable software (sometimes known as a UPnP Control Point), similar functionality is available for other computer types and for handheld devices using Apple's iOS or Android operating systems. In this mode the radio acts as a UPnP Renderer.

1. In order to use the 'Play to' function, the radio must be actively connected to the network. The first time that you use the 'Play to' function you will need to allow Windows to recognize your radio. To do this, please go to step 2. If you have previously used 'Play to' so that Windows remembers your radio and you have configured your radio to keep its network connection in standby mode, then go to step 3.
2. If your radio is not currently running, or does not have an active connection to your network, then should first switch on your radio and select the Music player mode. Then select 'Shared media' from the menu so that the radio establishes a connection with Windows Media Player on your PC. After this step, all other functions may be performed from your computer.
3. At your Windows 7 PC, locate the file, album or playlist that you wish to play on the radio.
4. Use the right-hand mouse button to pop-up a menu of options for the chosen item and select the 'Play to' option.
5. Windows should show you one or more devices, including your radio, to which you may choose to send the music. Highlight the radio item and click with the left mouse button.

6. Windows will then open a 'Play to' window showing the track or tracks to be played. Your computer will then take control of your radio. Your radio will then enter the Digital Media Renderer mode (DMR) and after a few seconds the radio will start playing. The display on the radio will show that it is in DMR mode.
7. While the radio is playing in DMR mode you can use the controls in the 'Play to' window on your computer to skip tracks, fast-forward or rewind, to pause or restart, and to change the volume on the radio. You may also use the controls on your radio to adjust volume, display track information (press the Info button) or to change operating mode. It is not possible to skip tracks or pause playback using the radio's controls while it is in DMR mode.
8. While playing, you may select additional content within Windows and again use the 'Play to' function (see step 3-5). The additional tracks will be added to the playlist in the current 'Play to' window. You may also delete or change the order of tracks within the 'Play to' window.
9. When you wish to exit DMR mode, simply either switch off your radio or press the mode button to select a different operating mode.

Don't forget that in order to reselect the DMR mode and to be able to use 'Play to' from Windows you must first ensure that your radio has an active connection to your network (see step 1 and 2 above).

**Note:**

Some Windows security software can prevent correct operation of the 'Play to' function. Such software may have updates or configuration options which will permit 'Play to' to operate correctly-please consult your anti-virus software supplier. The 'Play to' function in Windows 7 has been tested successfully with the WFR-27C radio when using Microsoft's security Essentials software without problems.



## DAB Radio

### Using DAB mode for the first time

1. Carefully extend the telescopic aerial.
2. Press the **Standby** button to switch on the radio. If the radio has been used before the last used mode will be selected.
3. Press the **Mode** button and rotate the **Tuning control Rotary** as needed so that DAB radio mode is selected on the display. Press the **Tuning Control Rotary** to select the option.
4. If this is the first time that DAB mode is used a quick scan of the Band III DAB channels will be carried out. The display will show 'Scanning'. (If the radio has been used before the last used station will be selected instead.) During the scanning process, as new stations are detected the station counter will increase and the stations will be added to the list which is stored in the radio. The bar graph indicates the progress of the scan.
5. When scanning is completed the radio will list the stations found (in numeric-alpha order 0...9...A...Z), unless it has previously been tuned to a DAB station. Rotate the Tuning Control Rotary to scroll through the list of available DAB radio stations. Press the Tuning Control Rotary to select the highlighted station. The display may show 'Connecting...' while the radio re-tunes. Press the Volume buttons to set the sound level as needed.
6. If the station list is still empty after the scan the display will show "No stations found". If no stations are found it may be necessary to relocate your radio to a position giving better reception.

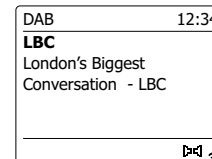
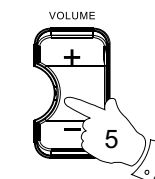
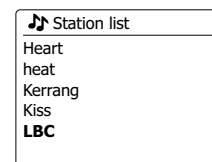
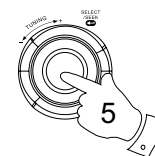
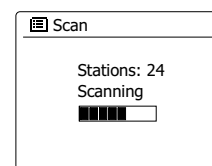
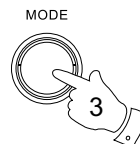

## Selecting a DAB radio station

1. When playing a DAB radio station, the display normally shows the name of the current station with other related information.
2. Rotate the **Tuning Control Rotary** to access the radio station list and to scroll through the available stations.
3. Press the **Tuning Control Rotary** to select the highlighted station. The display may show '*Connecting...*' while the radio re-tunes.
4. Use the **Volume** buttons to set the sound level as needed.

Note: If the display shows 'Station Not Available' it may be necessary to relocate your radio to a position giving better reception. A question-mark in front of the station name merely indicates that the station has not recently been detected by the radio. It may still be available.

## Secondary services

Some DAB radio stations can have one or more secondary stations associated with them. Typically these are not broadcast continually. If a station has a secondary station available then the secondary will appear in the list of station names beneath the main (or primary) station. Examples are the programs '*Daily Service*' and '*Parliament*' on BBC Radio 4.

1. To listen to a secondary service, rotate the **Tuning Control Rotary** to scroll to the chosen station, and press the **Tuning Control Rotary** to tune to the station. If the secondary service is not available (off-air) then the primary service will be selected.

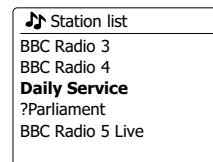
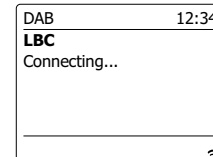
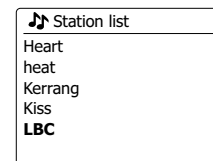
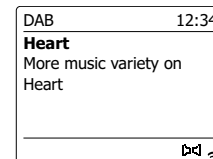
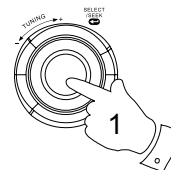
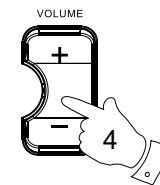
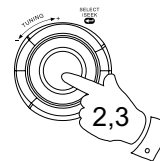

## Display modes

Your radio has a range of display options when in DAB mode:-

1. Press the **Info** button to cycle through the different options.

- |                               |  |
|-------------------------------|--|
| a. Text                       | Displays text messages such as the artist or track name, phone in number, traffic alerts, etc.   |
| b. Program Type               | Displays the type of station being listened to such as Pop, Classic, News etc.   |
| c. Multiplex Name / Frequency | Displays the name of the DAB multiplex to which the current station belongs as well as its broadcast frequency.  |
| d. Signal error / strength    | Displays the signal error and strength for the station being listened to. A lower error number indicates a better quality of radio signal. The signal strength graph can be used when positioning the radio or its antenna. For good reception the graph should occupy three or more blocks. |
| e. Bit rate and audio type    | Displays the digital bit rate and audio coding information for the station being listened to.  |
| f. Date                       | Displays the current date.   |

A signal strength indicator is always shown in the lower area of the display on the right hand side.

If the broadcast being received is in stereo, then the stereo speaker symbol will be shown.

If the currently tuned station has been stored as a preset, then the preset number will also be shown.

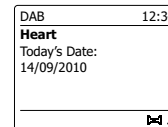
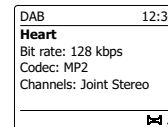
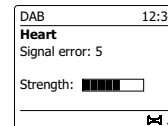
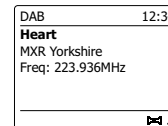
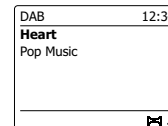
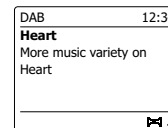



## Finding new DAB radio stations

Should you wish to use your radio for DAB reception in a new location, or if no stations were detected during the initial scan, you can follow this procedure to allow your radio to find out which DAB radio stations are available.

1. Ensure that the telescopic antenna is extended, and then press the **Mode** button and rotate the **Tuning Control Rotary** as needed to highlight DAB radio mode. Press the **Tuning Control Rotary** to select the option.
2. Once in DAB mode press the **Menu** button.
3. Rotate the **Tuning Control Rotary** until 'Scan' is highlighted on the display.
4. Press the **Tuning Control Rotary** to initiate the scan. The display will show 'Scanning' and your radio will perform a scan of the DAB Band III frequencies. As new stations are found the station counter will increase and stations will be added to the list. The bar graph indicates the progress of the scan.

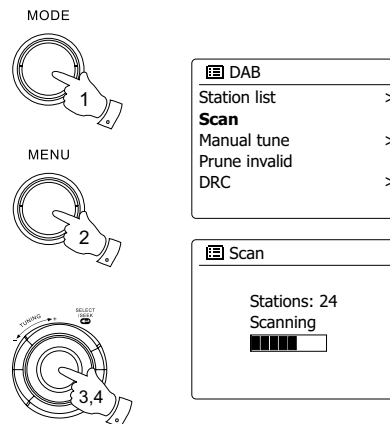

## Manual Tuning

Manual tuning allows you to tune directly to the various Band III DAB channels (5A to 13F).

1. When in DAB mode press the **Menu** button so that the display shows the DAB menu.
2. Rotate the **Tuning Control Rotary** until 'Manual tune' is highlighted.
3. Press the **Tuning Control Rotary** to enter manual tune option.
4. Rotate the **Tuning Control Rotary** to choose the required DAB channel.
5. Press the **Tuning Control Rotary** to cause the radio to tune to the chosen channel. When the radio has tuned, the display shows the channel number and frequency, and the name of the DAB multiplex found (if any). A bar graph shows the signal strength and is useful if you need to reposition the radio or its aerial. The minimum signal marker 'I' which separates the left and right parts of the signal graph shows the minimum signal level required for satisfactory reception. Any new radio stations found on the tuned DAB multiplex will be added to the list stored in the radio.
6. Press the **Back** button to choose a different frequency.
7. Press the **Menu** button a second time to access the main DAB menu then select 'Station list' to return to normal tuning.

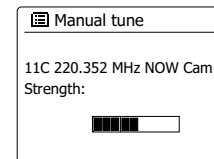
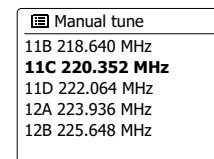
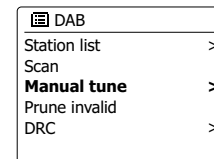
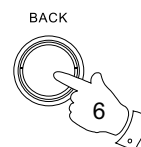
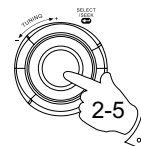
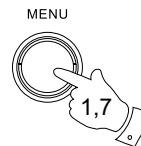

## Dynamic Range Control setting

Dynamic Range Control (also known as DRC) can make quieter sounds easier to hear when your radio is used in a noisy environment by reducing the dynamic range of the audio signal.

1. Press the **Standby** button to switch on your radio.
2. Press the **Mode** button and rotate the **Tuning Control Rotary** as needed to highlight DAB radio mode. Press the Tuning Control to select the option.
3. Press the **Menu** button to enter the DAB menu.
4. Rotate the **Tuning Control Rotary** until 'DRC' is highlighted on the display.
5. Press the **Tuning Control Rotary** to enter the DRC adjustment mode. The current DRC setting will be indicated with an asterisk.
6. Rotate the **Tuning Control Rotary** to highlight the required DRC setting (the default is Off).  
'DRC Off' - DRC is switched off, Broadcast DRC will be ignored.  
'DRC high' - DRC is set as sent by broadcaster.  
'DRC low' - DRC level is set to 1/2 that sent by broadcaster.
7. Press the **Tuning Control Rotary** to confirm the setting.

### Note:

Not all DAB broadcasts use the DRC function. If the broadcast does not provide DRC information, then the DRC setting in the radio will have no effect.

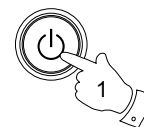

MODE



MENU

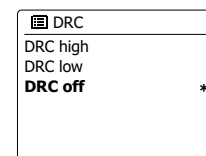
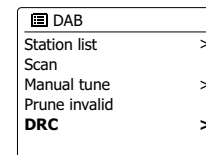
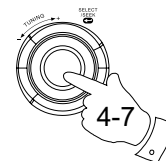

## Station order setup

Your radio has 3 station order settings from which you can choose. The station order settings are, alphanumeric, ensemble and valid.

### Note:

The default station order on your radio is alphanumeric.

1. Press the **Standby** button to switch on your radio.
2. Press the **Mode** button and rotate the Tuning Control Rotary as needed to highlight DAB radio mode. Press the Tuning Control Rotary to select the option.
3. Press the **Menu** button to enter the DAB menu list.
4. Rotate the **Tuning Control Rotary** until 'Station order' is highlighted. Press the **Tuning Control Rotary** to enter the station order adjustment mode.
5. Rotate the **Tuning Control Rotary** to choose between 'Alphanumeric', 'Ensemble' and 'Valid'.  
'Alphanumeric' - sorts the station list alpha-numerically 0...9 A...Z.  
'Ensemble' - organizes the station list by DAB multiplex.  
'Valid' - shows only those stations for which a signal can be found.  
The current setting is indicated by an asterisk.
6. Press the **Tuning Control Rotary** to select the required station order.
7. Press the **Back** button as needed to return to the DAB menu or to the stations list.



MODE



MENU

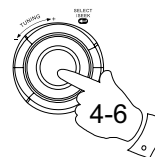
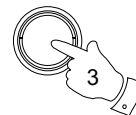

BACK

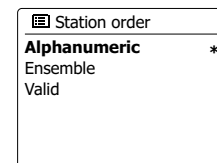
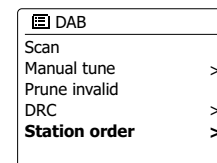

## Prune stations

If you move to a different part of the country, some of the stations which were listed may no longer be available. Also, from time to time, some DAB services may stop broadcasting, or may change location or frequency. Stations which cannot be found, or which have not been received for a very long time are shown in the station list with a question mark. The Prune stations function will delete the marked DAB stations from your station list.

1. Press the **Standby** button to switch on your radio.
2. Press the **Mode** button and rotate the **Tuning Control Rotary** as needed to highlight DAB radio mode. Press the **Tuning Control Rotary** to select the option.
3. Press the **Menu** button to enter the DAB menu.
4. Press the **Tuning Control Rotary** until 'Prune invalid' is highlighted. Press the **Tuning Control Rotary**.
5. To cause the stations list to be pruned, eliminating unavailable stations rotate the **Tuning Control Rotary** until 'YES' is highlighted on the display.
6. Press the **Tuning Control Rotary** to cause the invalid station names to be removed from the station list. If you do not wish to prune stations, highlight 'NO' and then press the **Tuning Control Rotary**. The display will revert to the previous menu.

### Note:

If you have moved your radio to a different part of the country you should also carry out a search for new stations (please see the section 'Finding new stations').

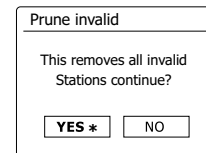
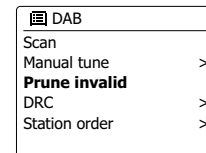
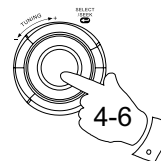
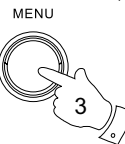
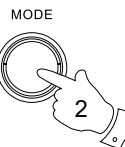
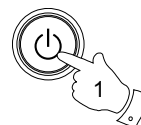

## FM Radio

### Operating your radio in FM mode

1. Carefully extend the telescopic aerial and press the **Standby** button to switch on your radio.
2. Press the **Mode** button and rotate the **Tuning Control Rotary** as needed to highlight FM radio mode. Press the **Tuning Control Rotary** to select the option.
3. Rotate the **Tuning Control Rotary** in a clockwise direction. The displayed frequency will increase. Press the **Tuning Control Rotary** to carry out an auto-tune. Your radio will scan up the FM band from the currently displayed frequency and will stop scanning when it finds a station of sufficient strength.
4. The display will show the frequency of the signal which has been found. If RDS information is available, after a few seconds the display will show the radio station name. If you only hear hiss or interference, simply press the **Tuning Control Rotary** to scan further. Your radio may have found a spurious interference signal.
5. To find more FM stations press the **Tuning Control Rotary** to repeat the scan operation. To scan down in frequency, rotate the **Tuning Control Rotary** in a anti-clockwise direction first and then press the **Tuning Control Rotary**. Your radio will scan down the FM band from the currently displayed frequency and will stop scanning when it finds a signal of sufficient strength.
6. When the end of the waveband is reached your radio will recommence tuning from the opposite end of the waveband. Use the Volume buttons to adjust the sound level as needed.



MODE



VOLUME

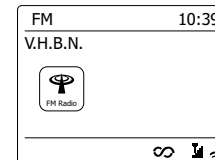
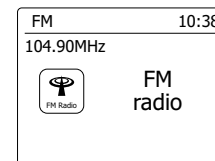
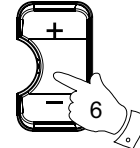

## Manual tuning

1. Carefully extend the telescopic aerial and press the Standby button to switch on your radio.
2. Press the **Mode** button and rotate the **Tuning Control Rotary** as needed to highlight FM radio mode. Press the **Tuning Control Rotary** to select the option.
3. Rotate the **Tuning Control Rotary** to control the frequency that the radio will tune to. The frequency will change in steps of 50kHz. When the end of the waveband is reached the radio will recommence tuning from the opposite end of the waveband.
4. Use the **Volume** buttons to adjust the sound level as needed.

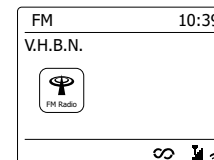
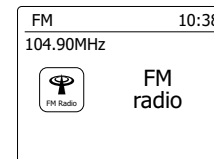
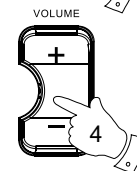
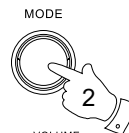

GB

## Display modes

Your radio has a range of display options when in FM mode:-

1. Press the **Info** button to cycle through the different options.
  - a. Text Displays text messages such as the artist or track name, phone in number, traffic alerts, etc.
  - b. Program Type Displays the type of station being listened to such as Pop, Classic, News etc.
  - c. Frequency Displays the frequency of the FM signal.
  - d. Date Displays the current date.

Note: If no RDS information is available, then the radio will only be able to display the frequency. There will be no text or program type information available under these conditions.

The radio only provides displays when there is information available. So if there is no text, for example, that display is not available.

The RDS indicator at the bottom of the display shows that there is some RDS data present in the broadcast being received.

The stereo speaker display shows that the radio is receiving a stereo broadcast (please see also 'Stereo/Mono switching').

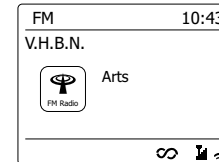
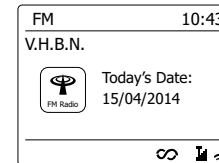
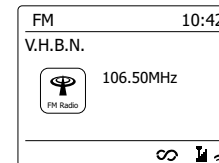
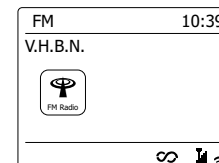
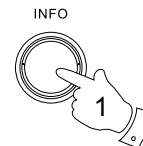



## Scan setting

When using the FM mode your radio can be set to either scan local stations or to scan all stations including distant radio stations.

1. Press the **Mode** button and rotate the **Tuning Control Rotary** as needed to highlight FM radio mode. Press the **Tuning Control Rotary** to select the option.
2. Press the **Menu** button to enter the FM menu.
3. Rotate the **Tuning Control Rotary** until 'Scan setting' is highlighted and then press the **Tuning Control Rotary** to enter the scan adjustment mode. The current scan setting is indicated with an asterisk.
4. To set your radio so that only the stations with the strongest signals are found during scanning rotate **Tuning Control Rotary** until 'YES' is highlighted. Press the **Tuning Control Rotary** to confirm the setting. (Normally this will restrict scanning to local transmissions.)

Alternatively, to set your radio so that all available stations are found during scanning (local and distant transmissions) rotate the Tuning Control Rotary until 'NO' is highlighted. Press the Tuning Control Rotary to confirm the setting.

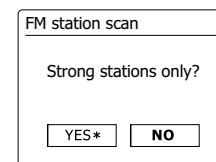
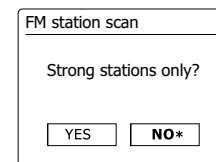
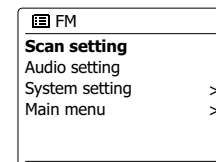
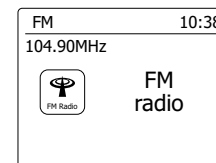
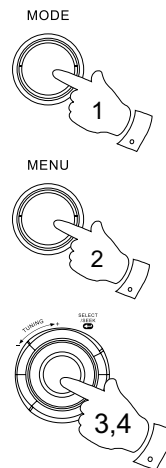

## Stereo / Mono switching

If the FM radio station being listened to has a weak signal, some hiss may be audible. It is possible to reduce this hiss by forcing the radio to play the station in mono rather than stereo.

1. Press the **Mode** button. Rotate and press the **Tuning Control Rotary** as needed to select the FM radio mode display and tune to the required FM station as previously described.
2. Press the **Menu** button to enter the FM menu.
3. Rotate the **Tuning Control Rotary** until 'Audio setting' is highlighted on the display. Press the **Tuning Control Rotary** to enter the audio setting mode. The current setting is indicated with an asterisk.
4. To switch to mono in order to reduce the hiss from a weak FM signal rotate the **Tuning Control Rotary** until 'YES' is highlighted. Press the **Tuning Control Rotary** to confirm the setting.

Alternatively, to return to the normal automatic 'stereo or mono' mode press the **Tuning Control Rotary** until 'NO' is highlighted. Press the **Tuning Control rotary** to confirm the setting.

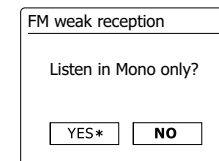
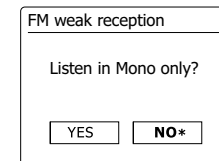
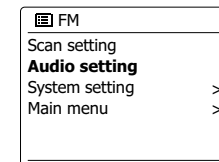
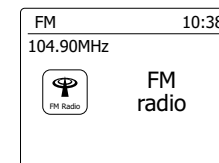
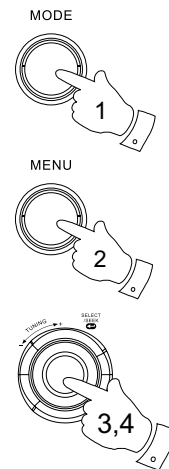

## Presetting stations in DAB and FM modes

There are 5 memory presets each for DAB and FM radio. They are used in the same way for each operating mode.

1. Press the **Standby** button to switch on your radio.
2. Tune to the required radio station as previously described.
3. To store the station as a preset, press and hold the required **Preset** button (1-5) until the display shows 'Preset stored'. The station will be stored under the chosen preset button. Repeat this procedure as needed for the remaining presets.
4. Stations which are already stored in the presets may be over written by following the above procedure.

### Note:

The radio station presets are retained in memory when the radio is switched off and disconnected from the mains supply.

## Recalling a preset in DAB and FM modes

1. Press the **Standby** button to switch on your radio.
2. Select the required operating mode.
3. Momentarily press the required **Preset** button. Your radio will then tune to the station stored in the selected preset memory. The chosen preset number is also shown in the lower area of the radio display, e.g. '★4'.

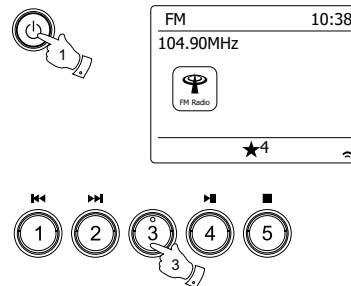
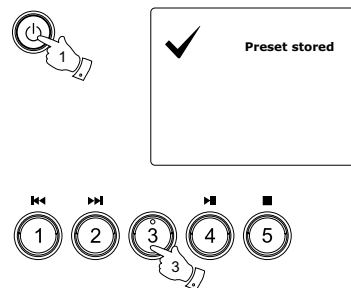

## Listening to Spotify

### Playing music using Spotify Connect

Introduce your radio to a whole new world of music. With Spotify, you can enjoy instant access to millions of songs

A Spotify Premium subscription is required.

For details, see the Spotify homepage.

<http://www.spotify.com>

The Spotify software is subject to third party licenses found here:

[www.spotify.com/connect/third-party-licenses](http://www.spotify.com/connect/third-party-licenses)

1. Prepare for playback

- Download Spotify app (  Spotify ) to your smartphone or tablet and log in to the app.
- Check the network environment and then turn on this radio's power (please refer to 'Configuration' in the previous section.)

#### Note:

It is necessary that your radio and your smartphone connect to the same wifi network, so that you can find the radio on your smartphone or tablet later.

- Ensure your radio has the "Keep Network Connected" option turned on to enable Spotify Connect to access the radio in Standby mode or non-network mode (DAB/ FM/ Aux-In).

2. Open Spotify on your smartphone, then enter the Playback screen as shown in the right side.

3. Press the **Mode** button and rotate the **Tuning Control Rotary** to highlight the Spotify mode display. Press the **Tuning Control Rotary** to select the option. The message 'Waiting for Users' is displayed.

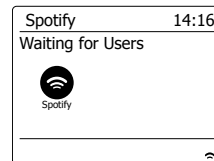
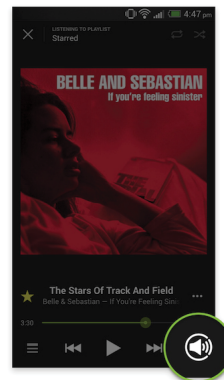

#### 4. Play tracks via your radio.

Press  the Connect icon at the bottom right corner of the screen and you should find your radio on the list. Press the item and your smartphone/ tablet is linked with your radio (e.g. WFR-28C). You can see the green Connect icon indicating the connect is on radio. Now you can listen to audio streamed wirelessly from your linked smartphone/ tablet.

#### Note:

If you cannot see the icon, it indicates no connect device available. Check your device's user manual or the manufacture's support site as a firmware upgrade may be required.

#### 5. Control playback.

Use the controls on your Connect-enabled device (i.e Smartphone/tablet) or controls on your radio to play or pause audio, navigate tracks and control volume.

#### 6. Disconnect Spotify from your radio

Press  the icon and you will see your smartphone on the list, press the item and Spotify will play via your smartphone. In addition, you can switch off your radio or use the mode button to select a different operating mode.

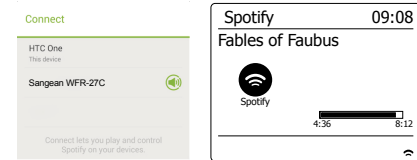

## Display mode- Spotify Connect

Your radio has a range of display options when playing Spotify Connect. Press the Info button to cycle through the different options

a. Progress bar Displays the playback progress for the track currently playing

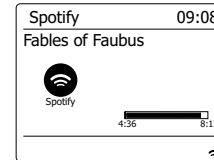

b. Artist Displays the name of the artist for the track currently playing



c. Album Displays the name of the album from which the current track is taken.



d. Bit rate Displays the bit rate and sampling rate of the track currently playing

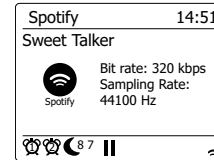

e. Playback buffer Displays the radios internal buffer level

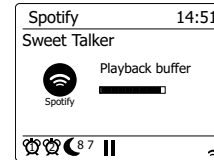

### Note:

If the Audio streaming from Spotify Connect is interrupted or stopped (e.g. control passed to another device), the message "Waiting for Users" is displayed.

## Streaming data rate - Spotify Connect

Your radio can change different music streaming quality when you stream content from Spotify. If your internet connection has a low data usage allowance, or has a relatively low maximum data rate, it is strongly suggested that your radio uses a lower streaming quality (data rate) for Spotify connections. In some cases this may allow more reliable streaming, although some loss of audio quality will occur.

The data rate used for Spotify Connect is configured on a web browser.

1. You need to access the radio's configuration web page following the steps below:  
Access the menu for the current mode by pressing the Menu button> Select "System settings"> Select "Network"> Select "View settings"> Use the Select button to enter the "View settings" and IP address is shown on the display> Note down the IP address shown on the display for the next stage> Ensure that your computer/ Smartphone is on the same network as the radio. Enter the IP address noted above into the address bar of your web browser.
2. When you enter the radio's configuration web page, the top page allows you to choose the streaming quality (96k/ 160k/ 320k). The selected streaming quality will be applied when your radio streams music from a new playlist of Spotify.

## Friendly name - Spotify Connect

You can personalize the name of your radio so that it can be easily identified within connected network, UPnP server or Spotify app.

1. Follow the steps described in point 1 above and you can view some of the radios settings as well as changing the "Friendly name."
2. Type the name in the box and click Apply to save the change. The new Friendly name will be viewable on the connect network devices.

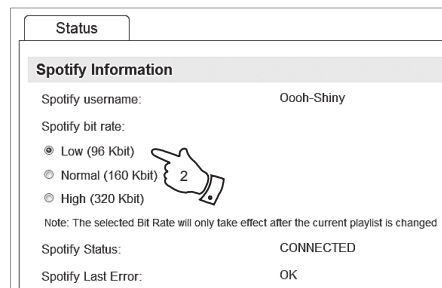
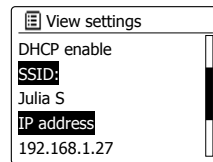
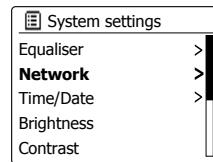
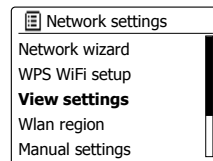
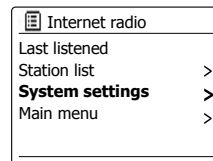

## Clock and Alarms

### Automatically updating the clock

Your radio will normally update the clock automatically when connected to the internet. If you enter a time setting manually, the radio will calculate a local time offset which is then stored in memory. Whenever it synchronizes the clock using the internet, including after a power failure, your radio will then set the clock automatically using this information.

You may wish to use the radio away from the internet, in which case you may specify that the unit sets its clock from DAB or FM radio broadcasts.

After a power failure the radio will then set its clock the next time that you turn on the radio in DAB or FM mode. Alternatively you may specify that the time is not automatically updated. In this case the clock must always be set manually after a power interruption.

1. With your radio switched on, press the **Menu** button to access the menu for the current mode.
2. Rotate the **Tuning Control Rotary** until 'System settings' is highlighted on the display. Press the **Tuning Control Rotary** to enter the system settings menu.
3. Rotate the **Tuning Control Rotary** until 'Time/Date' is highlighted on the display. Press the **Tuning Control Rotary** to enter the time setup.
4. Rotate **Tuning Control Rotary** until 'Auto update' is highlighted on the display. Press **Tuning Control Rotary** to enter the auto-update menu.
5. Rotate the **Tuning Control Rotary** to choose an update option from 'Update from DAB', 'Update from FM', 'Update from Network' or 'No update' as required. Press the **Tuning Control Rotary** to confirm your choice. The radio will then exit to the previous menu display.

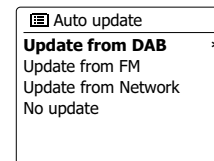
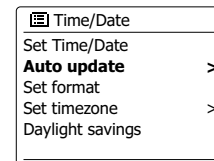
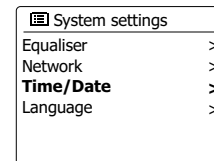
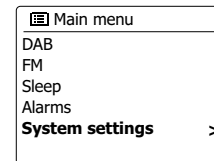
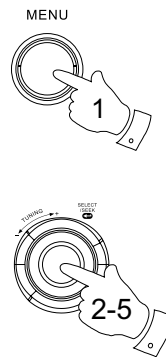



## Setting the clock format

The clock display used in standby mode and on the playing mode screens can be set to 12 or 24 hour format. The selected format is then also used when setting the alarms.

1. With your radio switched on, press the **Menu** button to access the menu for the current mode.
2. Rotate the **Tuning Control Rotary** until 'System settings' is highlighted on the display. Press the **Tuning Control Rotary** to enter the system settings menu.
3. Rotate the **Tuning Control Rotary** until 'Time/Date' is highlighted on the display. Press the **Tuning Control Rotary** to enter the time setup.
4. Rotate the **Tuning Control Rotary** until 'Set format' is highlighted on the display. Press the **Tuning Control Rotary** to enter the clock format menu. The current clock display format is marked with an asterisk.
5. Rotate the **Tuning Control Rotary** to select either 12 or 24 hour format. Press the **Tuning Control Rotary** to confirm your choice of clock format. The display will then revert to the previous menu.

If the 12 hour clock format is chosen, the radio will then use the 12 hour clock for the setting of alarms, and will display a 12 hour clock with an AM or PM indicator when in standby mode.

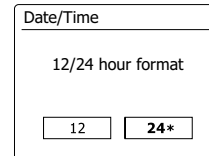
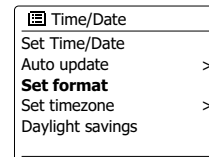
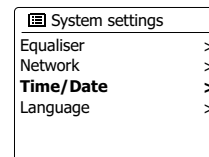
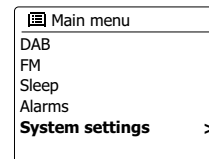
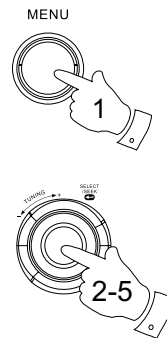

## Manually setting the clock

The WFR-27C radio will normally set its clock automatically to local time after a connection to the Internet has been established. Should you need to set the time manually, change the time zone, or manually switch from winter to summer time (GMT to BST - also known as daylight savings time), then please follow this procedure.

1. Press the Standby button to switch on your radio.
2. To set all time settings press the **Menu** button to access the menu for the current mode.
3. Rotate the **Tuning Control Rotary** until 'System settings' is highlighted on the display. Press the **Tuning Control Rotary** to enter the system settings menu.
4. To change the time zone setting go to step 11. To change from winter to summer time go to step 13. To change the current time or date setting rotate the **Tuning Control Rotary** until 'Time/Date' is highlighted on the display, then press the **Tuning Control Rotary** to enter the time and date setting screen.
5. Rotate the **Tuning Control Rotary** until 'Set Time/Date' is highlighted on the display. Press the **Tuning Control Rotary** to enter the clock setup. The day digits will flash.
6. Rotate the **Tuning Control Rotary** until the correct day is shown on the display. Press the **Tuning Control Rotary** to enter the selection. The month digits will then flash.
7. Rotate the **Tuning Control Rotary** to select the correct month. Press the **Tuning Control Rotary**. The year digits will then flash.



MENU

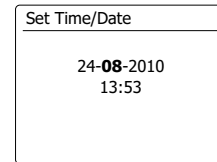
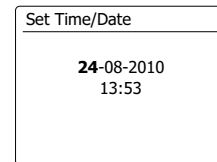
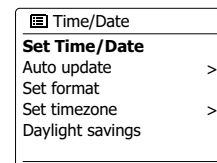
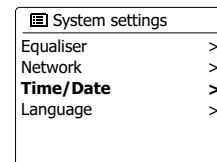
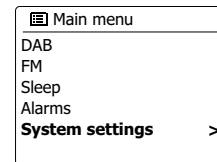
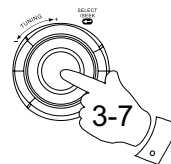
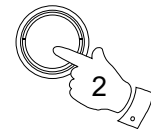

8. Rotate the **Tuning Control Rotary** to select the correct year. Press the **Tuning Control Rotary** to enter the selection. The hour digits will then flash.
9. Rotate the **Tuning Control Rotary** to select the correct hour. Press the **Tuning Control Rotary** to enter the selection. The minute digits will then flash.
10. Rotate the **Tuning Control Rotary** to select the correct minutes. Press the **Tuning Control Rotary** to enter the selection. The display will then return to the previous menu.
11. Rotate the **Tuning Control Rotary** until 'Set time zone' is highlighted on the display then press the **Tuning Control Rotary**.
12. Rotate the **Tuning Control Rotary** to highlight the time zone which is applicable to your location, then press the **Tuning Control Rotary** to confirm the setting.
13. Rotate the **Tuning Control Rotary** until 'Daylight savings' is highlighted on the display then press the **Tuning Control Rotary**. The asterisk shows the current setting. (In the UK, ON is equivalent to British Summer Time, OFF is equivalent to Greenwich Mean Time.)
14. Rotate the **Tuning Control Rotary** to highlight 'ON' or 'OFF' as required then press the **Tuning Control Rotary** to confirm the setting.

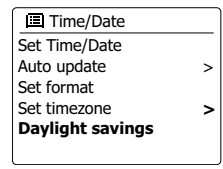
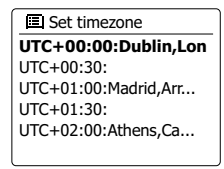
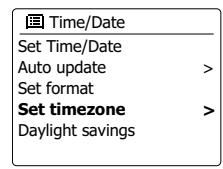
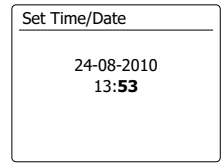
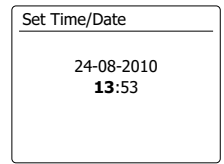
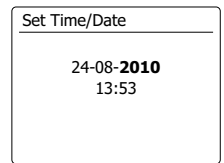
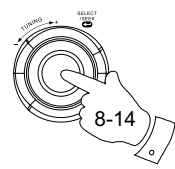

## Setting the alarm clock

Your radio has two separate alarms which can be set to wake you to either the radio, or a buzzer alarm. In the event of a power interruption your radio has built in memory that will retain your alarm settings. Ensure that the time is set correctly before setting the alarms.

1. Press the **Menu** button and rotate the **Tuning Control Rotary** until 'Main menu' is highlighted. Press the **Tuning Control Rotary** to enter the menu.
2. Rotate the **Tuning Control Rotary** until 'Alarms' is highlighted and press the **Tuning Control Rotary** to enter the selection.
3. Rotate the **Tuning Control Rotary** until the desired alarm (1 or 2) is highlighted on the display. Press the **Tuning Control Rotary** to enter alarm setup.
4. Rotate the **Tuning Control Rotary** until 'Time' is highlighted on the display. Press the **Tuning Control Rotary** to adjust the alarm time.
5. Rotate the **Tuning Control Rotary** to choose the alarm hour. Press the **Tuning Control Rotary** to confirm the setting.
6. Rotate the **Tuning Control Rotary** to choose the alarm minute. Press the **Tuning Control Rotary** to confirm the setting. The display will then return to the alarm setting menu. If the radio has been set to use a 12 hour clock format, there will also be an option here for setting AM or PM for the alarm time.

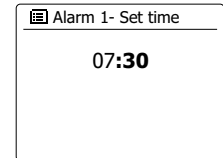
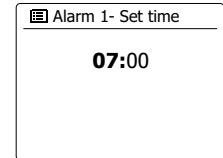
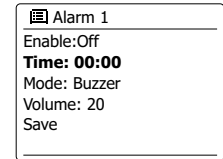
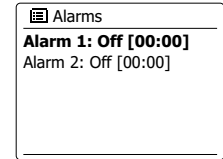
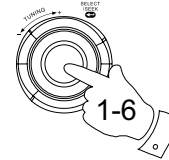
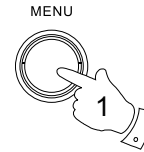

## Setting the alarm clock - cont.

7. Rotate the **Tuning Control Rotary** to highlight 'Enable' and press the **Tuning Control Rotary**.

The display will show the Frequency options for the alarm. The alarm frequency options are as follows:

'Off' - the alarm will be disabled

'Daily' - the alarm will sound everyday

'Once' - the alarm will sound once

'Weekends' - the alarm will sound only at weekends

'Weekdays' - the alarm will sound on weekdays only

Rotate the **Tuning Control Rotary** to choose the required alarm frequency option. Choosing Off will disable the alarm. Press the Tuning Control Rotary to confirm the selection. If you choose to set the alarm to Once you will also need to set the date using the **Tuning Control Rotary**.

8. The alarm can be set to buzzer, Internet radio, DAB radio, FM radio. For whichever radio mode is selected, the radio alarm may be set to any of the stations which have been stored as presets or to the station most recently listened to. Rotate the **Tuning Control Rotary** to highlight the current 'Mode' option for the alarm, then press the Tuning Control Rotary if you wish to change it. Rotate the Tuning Control Rotary to highlight either 'Buzzer' or the required mode. Press the **Tuning Control Rotary** to confirm the selection.

9. If setting the alarm to a radio option, rotate the **Tuning Control Rotary** to highlight the 'Preset:' option then press the **Tuning Control Rotary** if you wish to change it. Choose from either the radio station 'Last listened' to, or from the presets 1 - 5. Scroll to the chosen option and press the **Tuning Control Rotary** to confirm the selection. Note that you can only set the alarm to use a preset which has already been stored.

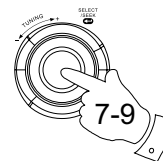

Alarm 1
<b>Enable:Off</b>
Time: 07:30
Mode: Buzzer
Volume: 20
Save

Alarm 1 frequency
Off
Daily
<b>Once</b>
Weekends
Weekdays

Alarm1 date/time
<b>24-08-2010</b>
07:30

Alarm 1
Enable:Once
Time: 07:30
<b>Mode: Buzzer</b>
Volume: 20
Save

Alarm 1 mode
<b>Buzzer</b>
Internet radio
DAB
FM

Alarm 1
Enable:Once
Time: 07:30
Mode: DAB
<b>Preset: Last listened</b>
Volume: 20

Alarm 1 preset
Last listened
<b>1. Radio Luxembourg</b>
2. Rick Antenne
3. Absolute Radio
4. [Not set]

## Setting the alarm clock - cont.

10. Rotate the **Tuning Control Rotary** until the 'Volume:' option is highlighted on the display and press the **Tuning Control Rotary** if you wish to change it. The radio uses the saved volume setting for each alarm when it sounds. Set the required volume using the **Tuning Control Rotary** to confirm the setting.
11. In order to store the alarm settings rotate the **Tuning Control Rotary** until 'Save' is highlighted. Press the **Tuning Control Rotary** to store the alarm settings. Your radio will show 'Alarm saved' and will then go back to the list of alarms with the new alarm setting shown in the display. If you decide not to save the settings, press the **Back** button. The display will show 'Save changes' with a 'YES' or 'NO' option. Rotate the Tuning Control Rotary to choose 'NO' and then press the **Tuning Control Rotary**. 'Alarm not saved' will show on the display. Active alarms are shown using small alarm indicators at the bottom of the playing displays and on the clock display when in standby.

### Note:

If you make a mistake at any point while setting the alarms, use the Back button to go back to the previous screen.

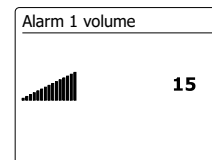
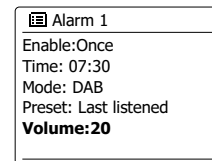
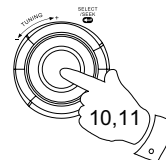

## When the alarm sounds

The buzzer or radio alarm will sound at the selected times for up to 60 minutes unless cancelled. The volume used for the alarm will be as specified during the alarm setting procedure. If the radio cannot connect to the specified radio station, the buzzer alarm will be used instead. To cancel an alarm, press the Standby button to return to standby mode. The alarm icon will flash at the bottom of the playing mode displays, and the radio will automatically switch back to standby mode when the 60 minutes have elapsed.

### Note:

If you have your earphone insert while the alarm is sounding, the sound of the alarm will come out from your earphone.

## Disabling alarms

1. To disable a single alarm enter the alarm setup menu and rotate the **Tuning Control Rotary** until the desired alarm is highlighted on the display. Press the **Tuning Control Rotary** to confirm.
2. Rotate the **Tuning Control Rotary** until the 'Enable:' option is highlighted on the display. Press the **Tuning Control Rotary**.
3. Rotate the **Tuning Control Rotary** to highlight 'Off' and press the **Tuning Control Rotary**.
4. Rotate the **Tuning Control Rotary** until the 'Save' option is highlighted on the display then press the **Tuning Control Rotary** to save the new setting. The chosen alarm will now be disabled.

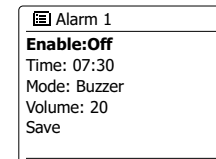
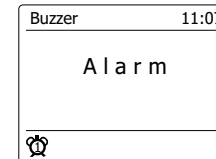
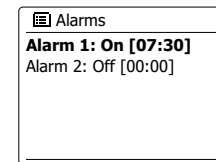
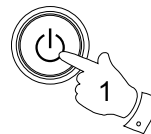

## Snooze timer

1. The buzzer or radio alarm can be silenced for 5 minutes by pressing the Alarm button. Should you wish for a longer snooze duration this can be extended. Pressing the Alarm button again while the radio is snoozed will set the available snooze time to 5, 10, 15 or 30 minutes.
2. While the snooze timer is active the remaining snooze time is shown next to the flashing alarm icon on the clock display.
3. In order to cancel the Snooze timer while the alarm is suspended, press the Standby button. The display will briefly show an 'Alarm Off' message.





## Sleep timer

Your radio can be set to turn off after a preset time has elapsed. The sleep timer setting can be adjusted between 15 and 120 minutes in 15 minute increments.

1. Press the **Menu** button and rotate the **Tuning Control Rotary** until 'Main menu' is highlighted. Press the **Tuning Control Rotary** to enter the menu.
2. Rotate the **Tuning Control Rotary** until 'Sleep' is highlighted. Press the **Tuning Control Rotary** to enter the setup. 'Sleep off' will appear on the display.
3. Rotate the **Tuning Control Rotary** to select the desired sleep time. The options are 15 to 120 minutes in 5 minutes increment. Use the OFF option to cancel the sleep function.
4. Your radio will switch off after the preset sleep time has elapsed.
5. Your radio will switch into standby mode after the preset time has elapsed. An active sleep timer is shown using a small timer indicator at the bottom of the playing displays. This indicator also shows the sleep time remaining before the radio switches itself into standby mode.
6. To cancel the sleep time before the preset time has elapsed and to turn off the radio, press the Standby button to turn the unit off manually. To cancel the sleep timer and leave the radio playing, go back into the sleep timer settings (steps 1 to 3 above) and select the Off option in step 3. Alternatively, simply press the **Standby** button twice in succession to cancel the timer and switch the radio back on again.

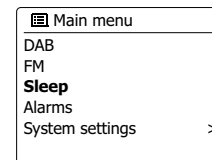
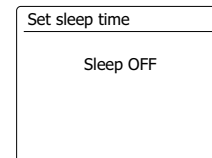
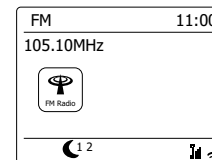
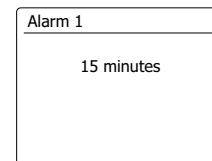
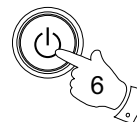
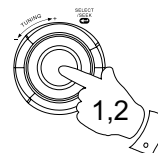
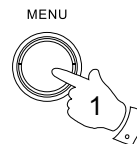

## Inactive standby

Your radio can be set to standby mode automatically if it idles for a preset period of time. The idle time setting can be adjusted between 2, 4, 5 and 6 hours.

1. Press the **Menu** button and rotate the **Tuning control Rotary** until 'System Settings' is highlighted. Press the **Tuning Control Rotary** to enter the menu.
2. Rotate the **Tuning Control Rotary** until 'Inactive Standby' is highlighted. Press the **Tuning Control Rotary** to enter the setup. Options for idle time will appear on the display.
3. Rotate the **Tuning Control Rotary** to select the desired idle time. Use the OFF option to cancel the inactive standby function.
4. Your radio will switch to standby mode when your radio idle for a preset period of time.

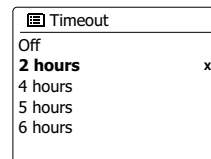
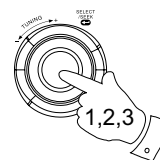
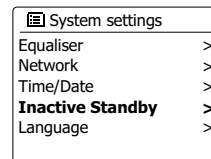
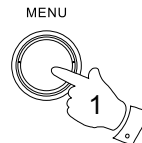

## Mute function

Pressing the **Mute** button will mute the output from the loudspeakers.

1. Press the **Mute** button to mute the sound output.
2. Press the **Mute** button again or one of Volume buttons to un-mute the sound output.



## Display and Audio

### Equalizer function

The sound on your radio can be adjusted to suit your personal taste for the material that you are listening to. The WFR-27C has a range of equalizer modes. Alternatively you may set the treble and bass levels to your own preferences which can be accessed from the My EQ menu item.

1. Press the **Menu** button and rotate the **Tuning Control Rotary** until 'System settings' is highlighted. Press the **Tuning Control Rotary** to enter the setup.
2. Rotate the **Tuning Control Rotary** until 'Equalizer' is highlighted on the display. Press the **Tuning Control Rotary** to confirm.
3. Rotate the **Tuning Control Rotary** to cycle through and highlight the various modes. Press the **Tuning Control Rotary** to confirm your selection.
  - a - Flat
  - b - Rock
  - c - Pop
  - d - Jazz
  - e - Classic
  - f - News
  - g - Movie
  - h - My EQ

The currently selected mode is marked with an asterisk.

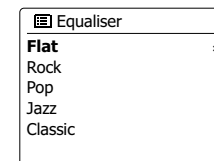
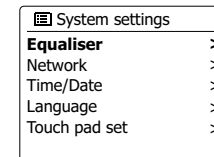
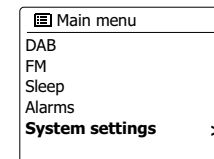
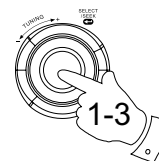
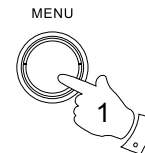

## Setting up your My EQ profile

If you find the preset equalizer functions not to your liking, you may set up a custom treble and bass setting as follows:

1. Follow steps 1-2 in the previous section in order to enter the Equalizer menu.
2. Rotate the **Tuning Control Rotary** until 'My EQ profile setup' is highlighted on the display. Press the **Tuning Control Rotary** to enter the adjustment mode.
3. To adjust the bass level rotate the **Tuning Control Rotary** until 'Bass' is highlighted on the display. Press the **Tuning Control Rotary** to enter the adjustment mode and rotate the **Tuning Control Rotary** until the desired level (between -14 and +14) is displayed. The sound will change as you adjust the level. Press the **Tuning Control Rotary** when you are happy with the bass setting.
4. To adjust the treble level rotate the **Tuning Control Rotary** until 'Treble' is highlighted on the display. Press the **Tuning Control Rotary** to enter the adjustment mode and rotate the **Tuning Control Rotary** until the desired level (between -14 and +14) is displayed. The sound will change as you adjust the level. Press the **Tuning Control Rotary** when you are happy with the treble setting.
5. To adjust the loudness rotate the **Tuning Control Rotary** until 'Loudness' is highlighted on the display. Press the **Tuning Control Rotary** to enter the setting and repeatedly press the **Tuning Control Rotary** to choose to activate or deactivate the loudness function.
6. Press the **Back** button and the display will prompt you to save the changes. If you wish to save the changes highlight 'YES'. If you do not wish to save the changes highlight 'NO'. Press the **Tuning Control Rotary** to enter the selection.
7. To use the 'My EQ' profile rotate the **Tuning Control Rotary** until 'My EQ' is highlighted, and then press the **Tuning Control Rotary** to make the selection.

The treble and bass settings will be remembered for the next time that you wish to use the 'My EQ' setting.

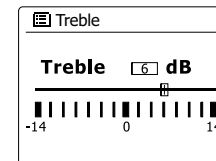
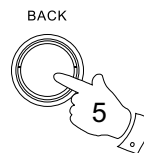
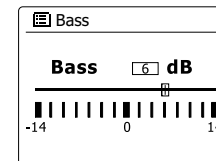
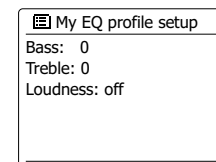
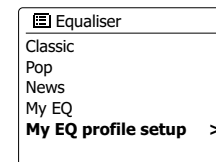
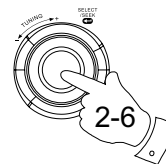

## Brightness control

The brightness of the display can be adjusted for when the radio is in standby and for when it is in use. If you use the unit in the bedroom, you may prefer a lower standby brightness level than a higher brightness setting.

1. Press the **Standby** button to switch on your radio. Access the menu for the current mode by pressing the **Menu** button.
2. Rotate the **Tuning Control Rotary** until 'System settings' is highlighted on the display. Press the **Tuning Control Rotary** to enter the system settings menu. Rotate the **Tuning Control Rotary** until 'Brightness' is highlighted on the display. Press the **Tuning Control Rotary** to confirm the setting.
3. In brightness menu, there are 3 settings:
  - Time out:** to adjust the length of time before the backlight turns off.
  - On level:** to adjust the the brightness when the radio is in use.
  - Dime level:** to adjust the brightness when the radio is in stanby. Rotate the **Tuning Control Rotary** to select your option and press the **Tuning Control Rotary** to confirm your setting.

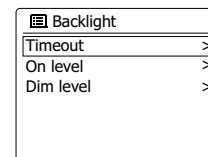
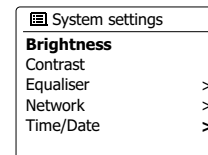
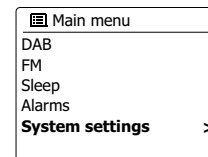
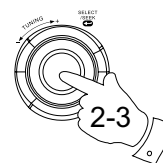
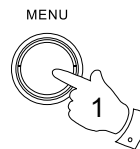
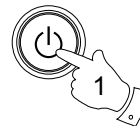

## Language selection

By default your radio will display all menus and messages in English. You can choose your preferred language.

1. Access the menu for the current mode by pressing the **Menu** button. Rotate the **Tuning Control Rotary** until 'System settings' is highlighted on the display. Press the **Tuning Control Rotary** to enter the settings menu.
2. Rotate the **Tuning Control Rotary** until 'Language' is highlighted on the display. Press the **Tuning Control Rotary** to enter the menu.
3. Rotate the Tuning Control Rotary until your preferred language is highlighted and press the Tuning Control Rotary to confirm the setting.

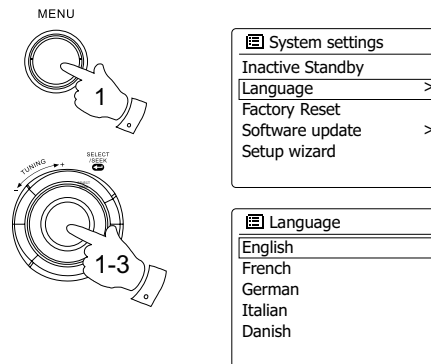

## Headphone socket

A 3.5mm Headphone Socket located on the left hand side of your radio is provided for use with headphones. Inserting a plug automatically mutes the internal loudspeaker.

Please be aware that the sensitivity of headphones can vary widely. We therefore recommend setting volume to a low level before connecting headphones to the radio. It is also recommended to reduce the volume before unplugging your headphones.

### IMPORTANT:

Excessive sound pressure from earphones and headphones can cause hearing loss.

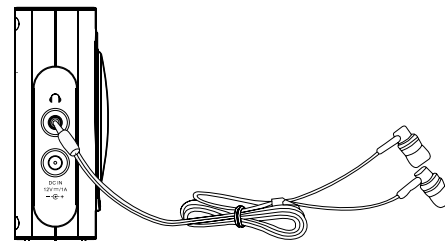

## Information

### Factory reset

If you wish to completely reset your radio to its initial state this may be performed by following this procedure. By performing a factory reset, all user entered settings will be erased.

1. Access the menu for the current mode by pressing the **Menu** button. Rotate the **Tuning Control Rotary** to highlight the 'Main menu' option, then press the **Tuning Control Rotary** to confirm.
2. Rotate the **Tuning Control Rotary** until 'System settings' is highlighted and then press the **Tuning Control Rotary** to confirm the setting.
3. Rotate the **Tuning Control Rotary** until 'Factory Reset' is highlighted and then press the **Tuning Control Rotary** to confirm the setting. Rotate the **Tuning Control Rotary** to highlight 'YES' to proceed. If you do not wish to carry out a system reset, highlight 'NO' and then press the **Tuning Control Rotary** to confirm the setting. The display will revert to the previous menu.
4. With 'YES' highlighted, a full reset will be performed and the radio will restart as if first plugged in. The DAB stations list together with any preset stations will be erased and your wireless network connection details will be lost. All configuration settings will be restored to their defaults, the clock and alarms will be reset.

In case of malfunction for any reason, reset the product as described above to resume normal operation. It may be necessary in some cases to disconnect the mains power, then reconnect power after 10 seconds. In case of malfunction due to electrical fast transient (burst), reset the product as above (reconnection of the power source may be required) to resume normal operation.

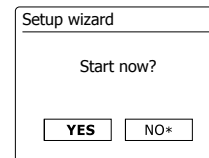
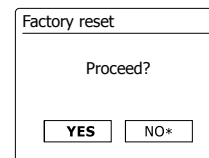
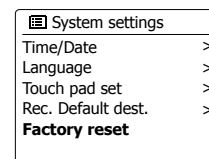
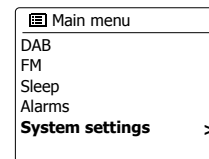
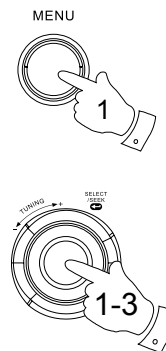

## Software update

From time to time, new software features for your radio may be developed. Your radio has therefore been designed to allow its internal software to be updated using your Internet connection. You should not attempt to update your radio unless it is recommended to you by Sangean Customer Services. Updating the software may remove all network settings, radio station presets and alarm settings from your radio. It is important that you do not attempt this procedure unless you have a good Internet connection and a reliable mains power supply. If the radio connects to your router using a WiFi connection, make sure that this is also reliable before proceeding.

1. The 'Software update' option is accessed via the 'System settings' menu. When you select 'Software update' the menu will display 'Auto check setting' and 'Check now'. If you want your radio to check periodically for new software versions rotate the **Tuning Control Rotary** to highlight 'Auto check settings'. Then press the **Tuning Control Rotary** and select 'YES'. If you do not want your radio to check for updates select the 'NO' option.
2. To check if there are any software updates available currently, press the **Tuning Control Rotary** to highlight 'Check now' and then press the **Tuning Control Rotary** to confirm the setting. The radio will check to see if an update is available. The display will show 'Checking for new versions'. If there are no updates then the display will show 'Software up to date'. If a software update is available your radio will then offer the choice of updating the software or not, displaying 'New version available. Update software?'. Select the 'YES' option if you wish to go through the update process.
3. If you choose to update your radio it will first download the new software and will then reprogram its internal memory. This may take a few minutes depending on the speed of your internet connection.
4. Once the software update is completed, the radio will prompt you to press select to restart. Press the **Tuning Control Rotary** and your radio will then restart. You may find that you will need to reconfigure your network connection following an update. You may also need to re-enter all radio station presets, alarm settings, and configuration options.

**VERY IMPORTANT:** Do not switch off the power to the radio until the update operation is complete and the radio has restarted, otherwise the unit may become permanently damaged.

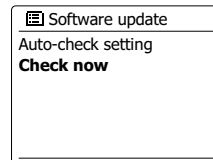
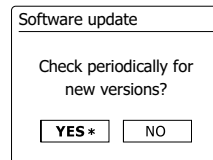
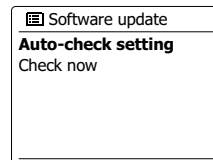
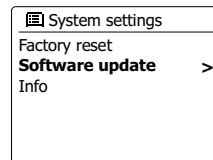
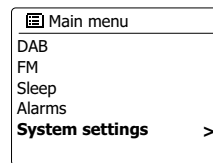



## Network profiles

Each time that you connect your radio to a WiFi network, the radio will store the details of that connection (SSID, security key, DHCP/IP address settings) as a profile. Up to four such profiles are stored in the radio so that if the unit is used in multiple locations there is no need to enter the network settings when returning to a location previously visited.

The radios stores the four most recent profiles in memory identified by their SSID. Normally the radio will attempt to connect to one of the stored profiles and only if it is unable to do so will you need to use the Network Wizard.

In the event that you visit a location only once you may wish to delete the profile for the network in that location to avoid losing other profiles.

1. Access the menu for the current mode by pressing the **Menu** button. Rotate the **Tuning Control Rotary** until 'System settings' is highlighted on the display. Press the **Tuning Control Rotary** to enter the settings menu.
2. Rotate the **Tuning Control Rotary** until 'Network' is highlighted on the display. Press the **Tuning Control Rotary** to enter the Network settings menu.
3. Rotate the **Tuning Control Rotary** until 'Network profile' is highlighted on the display. Press the **Tuning Control Rotary** to see the stored profiles. The profile which is currently in use (if any) is marked with an asterisk.
4. To remove a profile from memory, rotate the **Tuning Control Rotary** to highlight the profile to be deleted and then press the **Tuning Control Rotary** to confirm the setting.
5. The radio will offer a 'YES' or 'NO' selection. Rotate the Tuning Control Rotary to select 'YES' and then press the **Tuning Control Rotary** to confirm the setting. The selected profile will be deleted.

### Note:

that it is not possible to delete a profile which is currently in use.

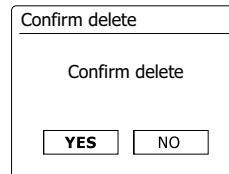
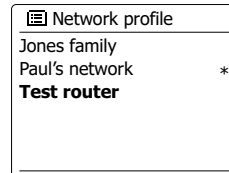
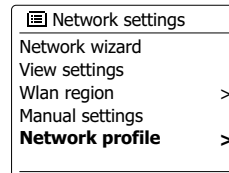
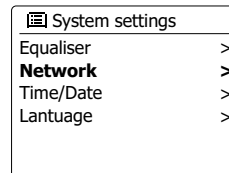
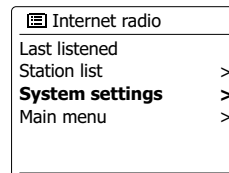

## Software version display

The software version display is provided for reference and customer support purposes and cannot be changed.

1. Access the menu for the current mode by pressing the **Menu** button. Rotate the Tuning Control Rotary until 'System settings' is highlighted on the display. Press the **Tuning Control Rotary** to enter the System settings menu.
2. Rotate the **Tuning Control Rotary** until 'Info' is highlighted on the display. Press the **Tuning Control Rotary** to display the software version and radio ID.

## Audio FAQ

Your radio can access some audio help for Internet Radio use.

1. With your radio switched on and in the Internet Radio mode, rotate the **Tuning Control Rotary** until 'Station list' is highlighted on the display and the **Tuning Control Rotary**.
2. Rotate the **Tuning Control Rotary** until 'Help' is highlighted on the display. Press the **Tuning Control Rotary** to enter the Help menu.
3. Rotate the **Tuning Control Rotary** until 'FAQ' is highlighted. Press the **Tuning Control Rotary** to display some frequently asked questions.
4. Rotate the **Tuning Control Rotary** to choose a question that suits your requirements and press the **Tuning Control Rotary** to listen to the answer. Adjust the volume as needed.

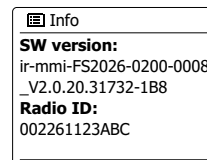
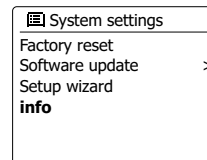
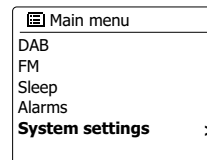

## Accessing your audio files via a UPnP server using Windows Vista and XP

If your computer is running Windows Vista or XP, then Windows Media Player version 11 includes a UPnP server which will make your files available to your radio. There are other UPnP server solutions available for non-Windows users and for Windows users who may wish to use an alternative (see the section of Use with Windows, Apple Mac and Linux).

It is beyond the scope of this instruction book to cover all possible options for UPnP. We explain the use of Microsoft's Windows Media Player here since that will be the first choice for the majority of users.

### Set up UPnP access on a Windows PC

1. If your PC is running Microsoft Windows Vista or Windows XP then you can use Microsoft's Windows Media Player version 11 to act as your UPnP (Universal Plug and Play) media server. If not already installed on your PC, Windows Media Player 11 may be downloaded from Microsoft's web site and installed by following the instructions detailed in its installation wizard, or by using Microsoft's Windows Update facility.
2. Once installed, Windows Media Player 11 can create a library from all the media files available to it on your PC. To add new media files to the library, select the 'Library' tab, then 'Add to Library... > Advanced Options', click 'Add', choose the files you wish to add and click 'OK'.

The next step is to connect your radio to Windows Media Player 11 and to configure the program to allow the radio to access your media library.

3. Press the Standby button to switch the unit on. Then press the **Mode** button and rotate the **Tuning Control Rotary** as needed until the Music Player mode display is shown. Press the **Tuning Control Rotary** to select the option. The main 'Music Player' menu will then be displayed.

## Set up UPnP access on a Windows PC - cont.

4. Rotate the **Tuning Control Rotary** until 'Shared media' is highlighted and press the **Tuning Control Rotary**. The radio will scan for all available UPnP servers. It may take a few seconds for the radio to complete its scan. The radio will display '<Empty>' if no UPnP servers are found.
5. After scanning, select your UPnP server using the **Tuning Control Rotary**. If you are using WMP 11 as the server, your radio will then normally display 'Unauthorized - Select to retry' at this stage.
6. Your PC may prompt you that there has been a connection to your UPnP server. Whether prompted or not, in order that the radio may access the music files, you will need to click the 'Library' tab in WMP 11 and select the 'Media Sharing...' item to open the 'Media Sharing' window. Make sure the box 'Share my media to:' is ticked.
7. In the 'Media Sharing' window, the radio will be listed as an unknown device. Click on the unknown device shown to select it, then click the 'Allow' button and then click 'OK'.

### **Note:**

If you are using Microsoft Windows' firewall software, this should be correctly configured by WMP 11. If you are using third party firewall software you may need to manually configure it to allow your unit and WMP 11 to communicate.

8. On the radio, select the named server again using the **Tuning Control Rotary**. If WMP 11 is now able to communicate with your radio you will be presented with some media selection options on the display.

## Audio codecs

Your radio supports a range of audio codecs which provide compatibility with a wide range of Internet Radio stations. These also allow users to stream music from their computers.

Note that for any given audio codec, there are many streaming protocols available, and thus even if an Internet Radio station uses a supported format, this does not guarantee that every such station will work with your radio. The radio stations database to which your radio connects is checked for compatibility so that most stations should be playable without problems. Similarly when streaming media from a computer, while a codec may be supported, there can be many subtle variations in formats, tagging schemes and protocols (even within UPnP). In general your radio will play the supported formats with most common UPnP servers.

## Bit-Rates

The following table summarizes the maximum supported bit-rates for the various audio formats that are playable on your radio. Higher rates may be playable in some cases but performance of the product may be affected.

<b>Codec</b>	<b>Maximum supported rate</b>
AAC (LC)	320 kbits/sec
MP3	320 kbits/sec
Real Audio	64 kbits/sec
WAV	1.536 Mbits/sec
WMA (3)	320 kbits/sec

All codecs support 2-channel (stereo) coded files only.

All codecs support sample rates up to 48 kbits/sec (includes 32 and 44.1 kbits/sec).

Files which have Digital Rights Management (DRM) protection applied will not be playable on your radio.

(1) The maximum supported bit-rate is for a 48 kHz sampling, 2 channels and 16-bits per sample.

(2) WMA Lossless, WMA Voice, WMA 10 Professional, and files which have DRM protection are not supported.

## Cautions

Do not allow your radio to be exposed to water, steam or sand.

Do not leave your radio where excessive heat could cause damage.

The name plate is located on the rear of the radio.

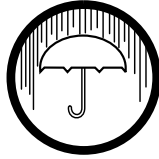

- The radio shall not be exposed to dripping or splashing and no objects filled with liquids, such as vases, shall be placed on the radio.
- It is recommended to operate the product such that there is a minimum distance (10cm recommended) to adjacent objects in order to ensure good ventilation.
- The ventilation of the product should not be restricted by covering it with items such as newspapers, tablecloths, curtains etc.
- No naked flame sources such as lighted candles should be placed on the product.
- It is recommended to avoid using or storing the product at extremes of temperature. Avoid leaving the unit in cars, on windows sills, in direct sunlight etc.
- The radio must be used in a moderate climate.

## Specifications

### Power Requirements

Mains Power Supply AC 100- 240 V/50/60 Hz/12W

### Frequency Coverage

FM 87.5 - 108 MHz

DAB 174.928 - 239.200 MHz

WiFi 802.11b and 802.11g supported with WEP and WPA/WPA2 encryption  
Compatible with 802.11n routers which offer mixed mode support for 802.11b/g  
Support dual frequency 5G/2.4G router  
WiFi 5G: 5.15GHz~5.25GHz(Band 1) for indoor-only use.

## Circuit features

Output power 1W

Headphone socket 3.5 mm diameter, stereo

Aerial System DAB Telescopic aerial  
FM Telescopic aeria

GB

*The company reserves the right to amend the specification without notice.*



*If at any time in the future you should need to dispose of this product please note that: Waste electrical products should not be disposed of with household waste. Please recycle where facilities exist. Check with your Local Authority or retailer for recycling advice. (Waste Electrical and Electronic Equipment Directive)*