

POTTING BOXES

100 Series Open Potting Boxes

Comprehensive range of open top potting boxes.
Maximum protection against shock, chemicals, moisture and temperature.

- Encapsulate and protect electronic components
- Moulded in ABS
- Highly resistant to most chemicals
- High rigidity and impact strength
- Compliant with water absorption specifications to DIN53495

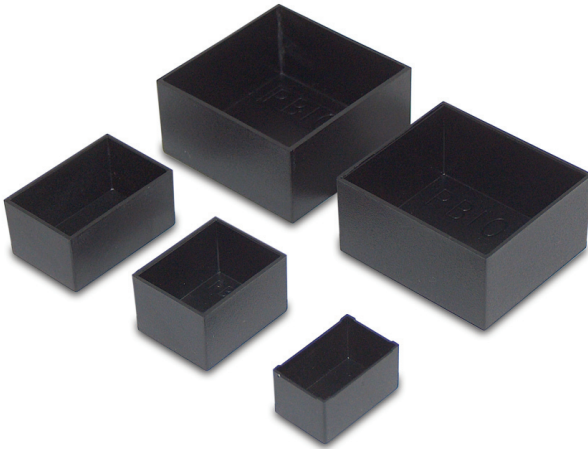

SPECIFICATION

Materials	ABS, UL94-V0 to order
Operating temperature	-20°C to +94°C
Standard colours	Black
Standard unit includes	Box Packs of 10

BLACK	LENGTH	WIDTH	HEIGHT	WALL THICKNESS
RTM101-BLK	25mm	20mm	15mm	1mm
RTM102-BLK	30mm	20mm	15mm	1mm
RTM103-BLK	40mm	35mm	20mm	1mm
RTM104-BLK	50mm	40mm	30mm	1mm
RTM105-BLK	75mm	50mm	35mm	1.4mm
RTM106-BLK	100mm	60mm	25mm	1.5mm
RTM107-BLK	40mm	40mm	20mm	1mm
RTM108-BLK	50mm	50mm	30mm	1mm
RTM109-BLK	11mm	11mm	9mm	0.5mm
RTM110-BLK	22mm	14mm	9mm	0.5mm
RTM111-BLK	30mm	30mm	20mm	1mm
RTM112-BLK	25mm	25mm	25mm	1mm
RTM113-BLK	40mm	40mm	30mm	1mm
RTM114-BLK	75mm	75mm	40mm	1mm
RTM115-BLK	89mm	64mm	33mm	1.5mm
RTM116-BLK	100mm	50mm	25mm	1.3mm

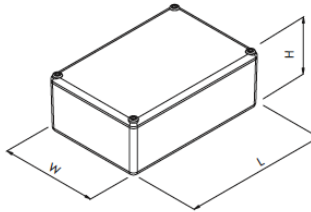

UNIVERSAL ENCLOSURES

HAND HELD CASES

HEAVY DUTY ENCLOSURES

DIN RAIL BOXES

INTERFACE SUPPORTS

CONTROL STATIONS

DIECAST & METAL BOXES

DESKTOP & INSTRUMENT CASES

POTTING BOXES

19" ENCLOSURES

19" CABINETS

DEVELOPMENT BOARDS

CUSTOM SIZED ENCLOSURES

CUSTOM SERVICES

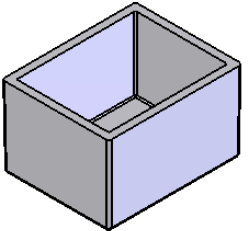
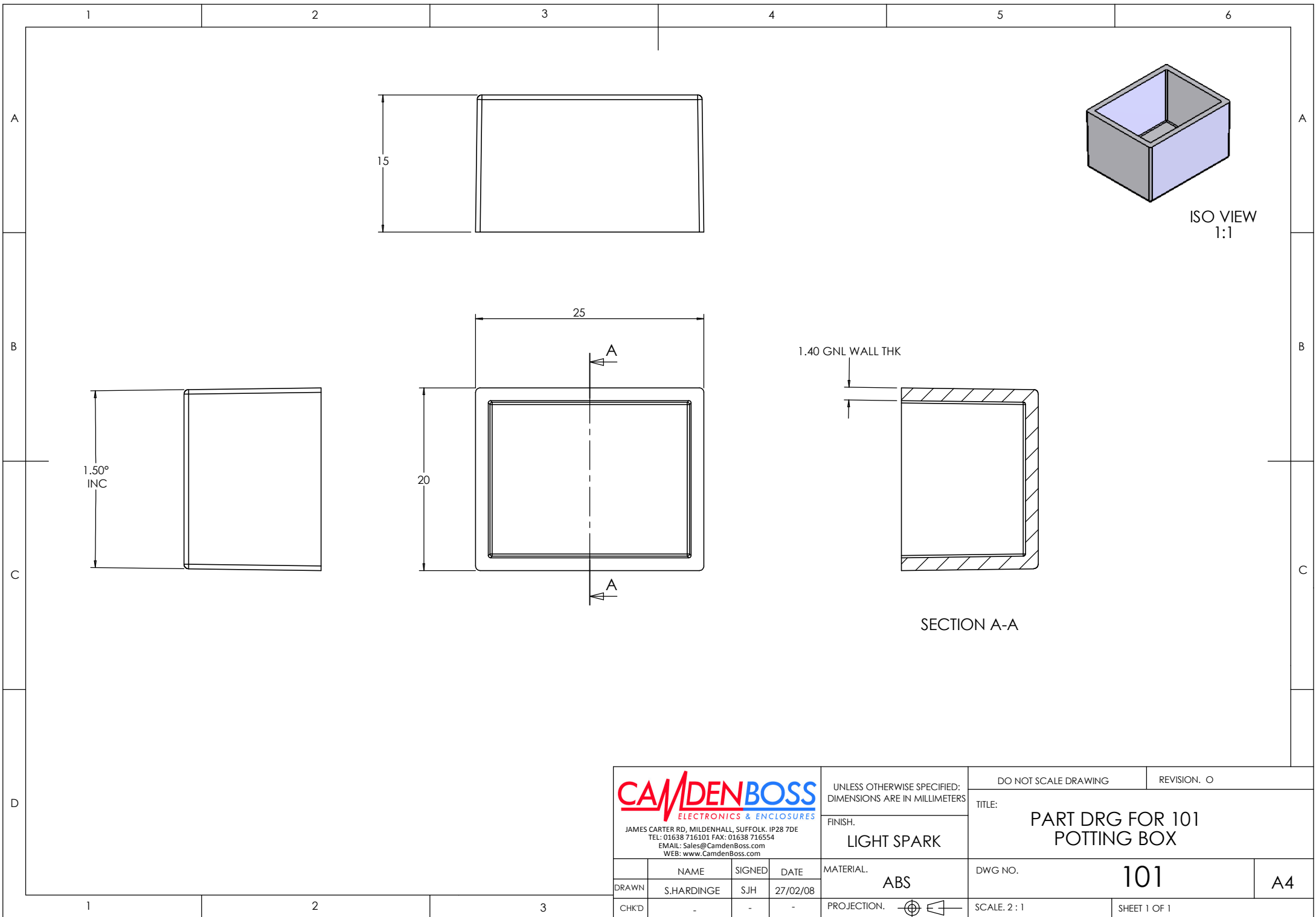

ISO VIEW
1:1

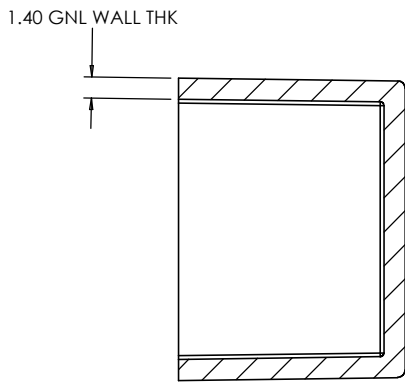

SECTION A-A

<p>CAMDENBOSS ELECTRONICS & ENCLOSURES</p> <p>JAMES CARTER RD, MILDENHALL, SUFFOLK. IP28 7DE TEL: 01638 716101 FAX: 01638 716554 EMAIL: Sales@CamdenBoss.com WEB: www.CamdenBoss.com</p>				UNLESS OTHERWISE SPECIFIED: DIMENSIONS ARE IN MILLIMETERS		DO NOT SCALE DRAWING		REVISION. O	
				FINISH. LIGHT SPARK		TITLE: PART DRG FOR 101 POTTING BOX			
DRAWN S.HARDINGE		SIGNED SJH	DATE 27/02/08	MATERIAL. ABS		DWG NO. 101		A4	
CHK'D -		-	-	PROJECTION.		SCALE. 2 : 1		SHEET 1 OF 1	

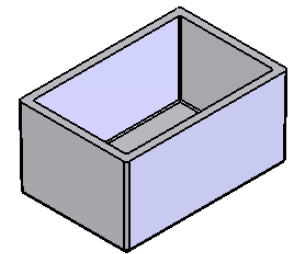
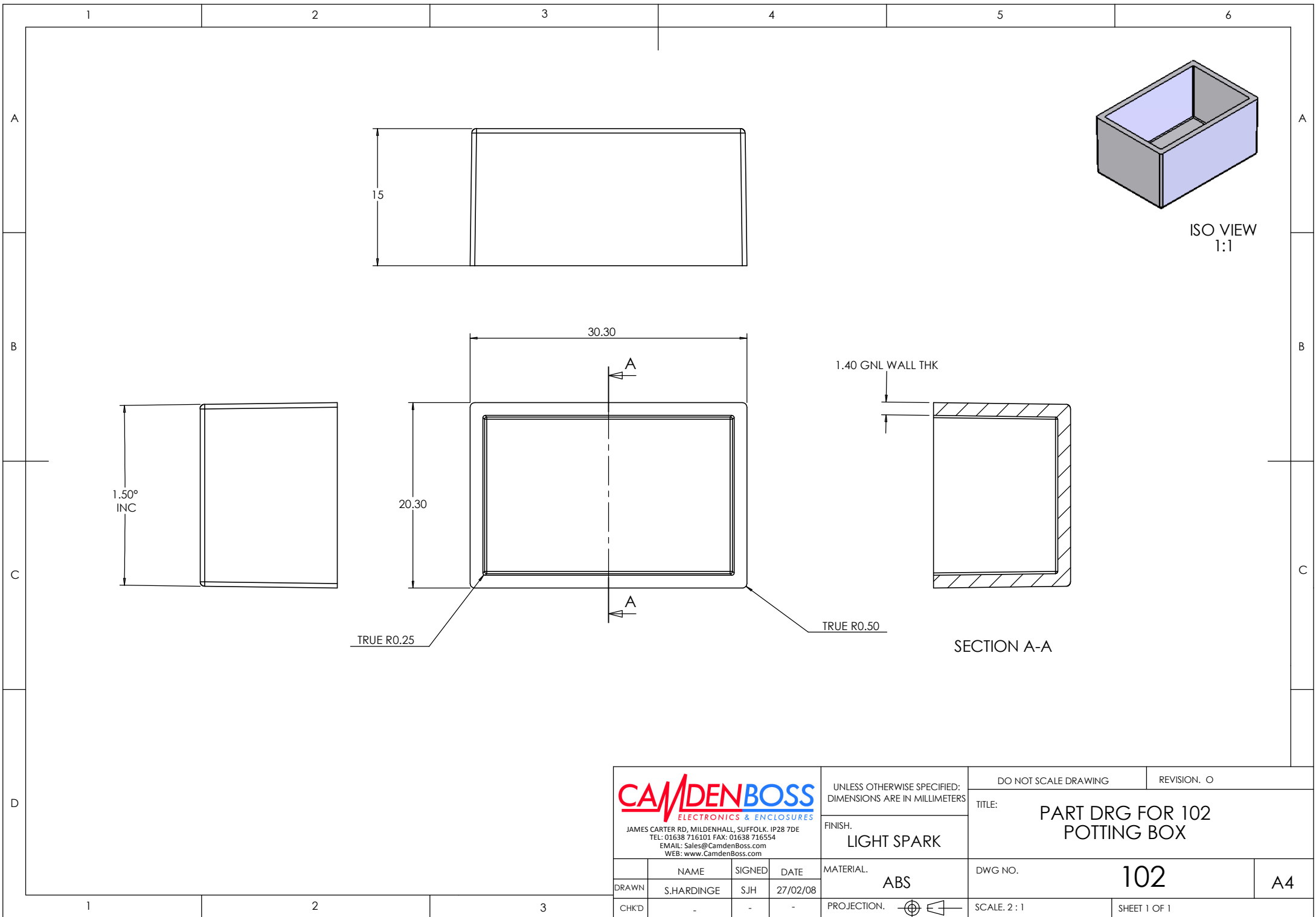

ISO VIEW
1:1

SECTION A-A

 JAMES CARTER RD, MILDENHALL, SUFFOLK. IP28 7DE TEL: 01638 716101 FAX: 01638 716554 EMAIL: Sales@CamdenBoss.com WEB: www.CamdenBoss.com				UNLESS OTHERWISE SPECIFIED: DIMENSIONS ARE IN MILLIMETERS		DO NOT SCALE DRAWING		REVISION. O	
				FINISH. LIGHT SPARK		TITLE: PART DRG FOR 102 POTTING BOX			
DRAWN S.HARDINGE		SIGNED SJH	DATE 27/02/08	MATERIAL. ABS		DWG NO. 102		A4	
CHK'D -		-	-	PROJECTION.		SCALE: 2:1		SHEET 1 OF 1	

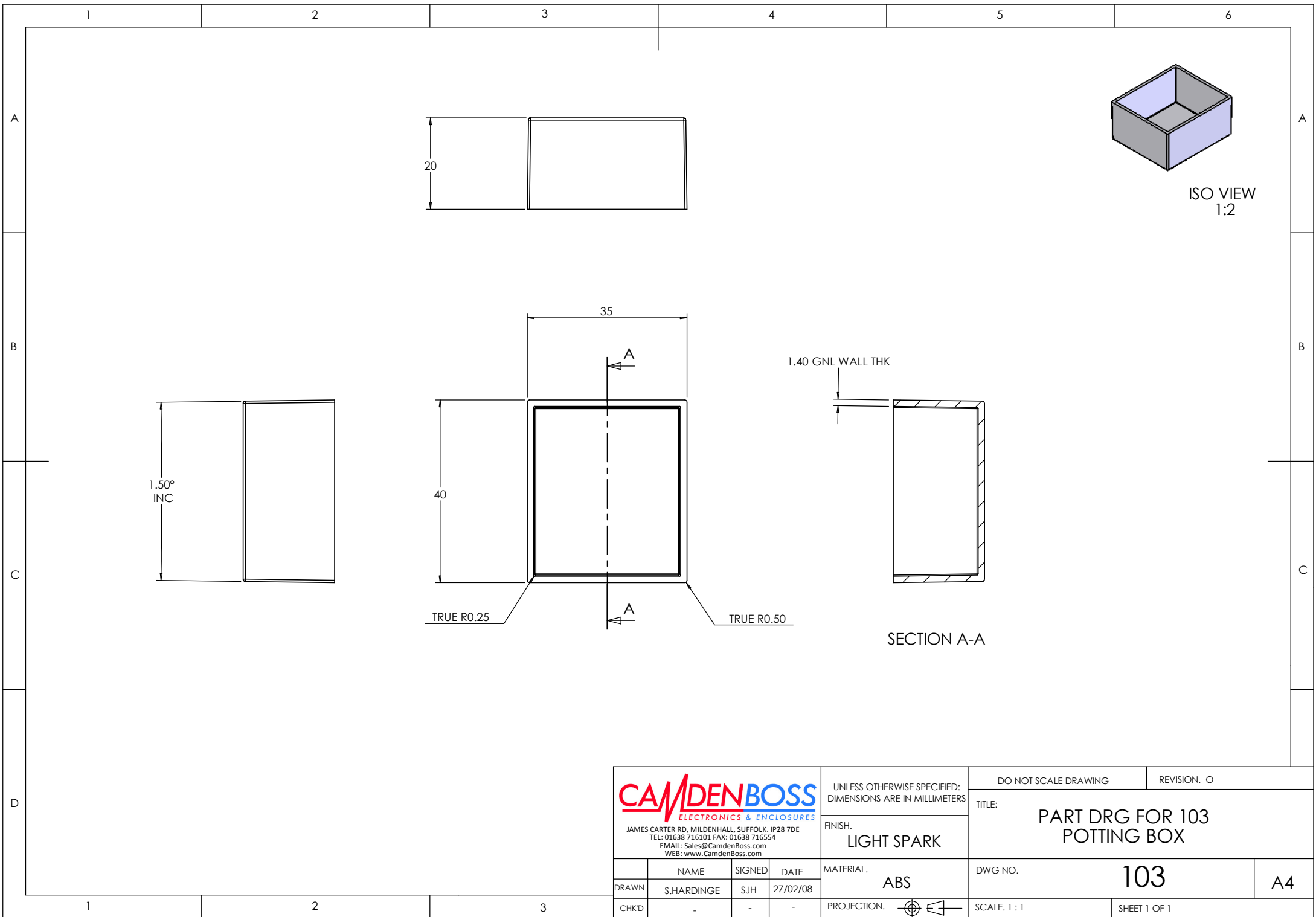

CAMDENBOSS
 ELECTRONICS & ENCLOSURES
 JAMES CARTER RD, MILDENHALL, SUFFOLK. IP28 7DE
 TEL: 01638 716101 FAX: 01638 716554
 EMAIL: Sales@CamdenBoss.com
 WEB: www.CamdenBoss.com

UNLESS OTHERWISE SPECIFIED:
 DIMENSIONS ARE IN MILLIMETERS

FINISH:
 LIGHT SPARK

DO NOT SCALE DRAWING REVISION. O

TITLE: PART DRG FOR 103 POTTING BOX

	NAME	SIGNED	DATE
DRAWN	S.HARDINGE	SJH	27/02/08
CHK'D	-	-	-

MATERIAL:
 ABS

PROJECTION.

DWG NO.	103	A4
SCALE: 1 : 1	SHEET 1 OF 1	

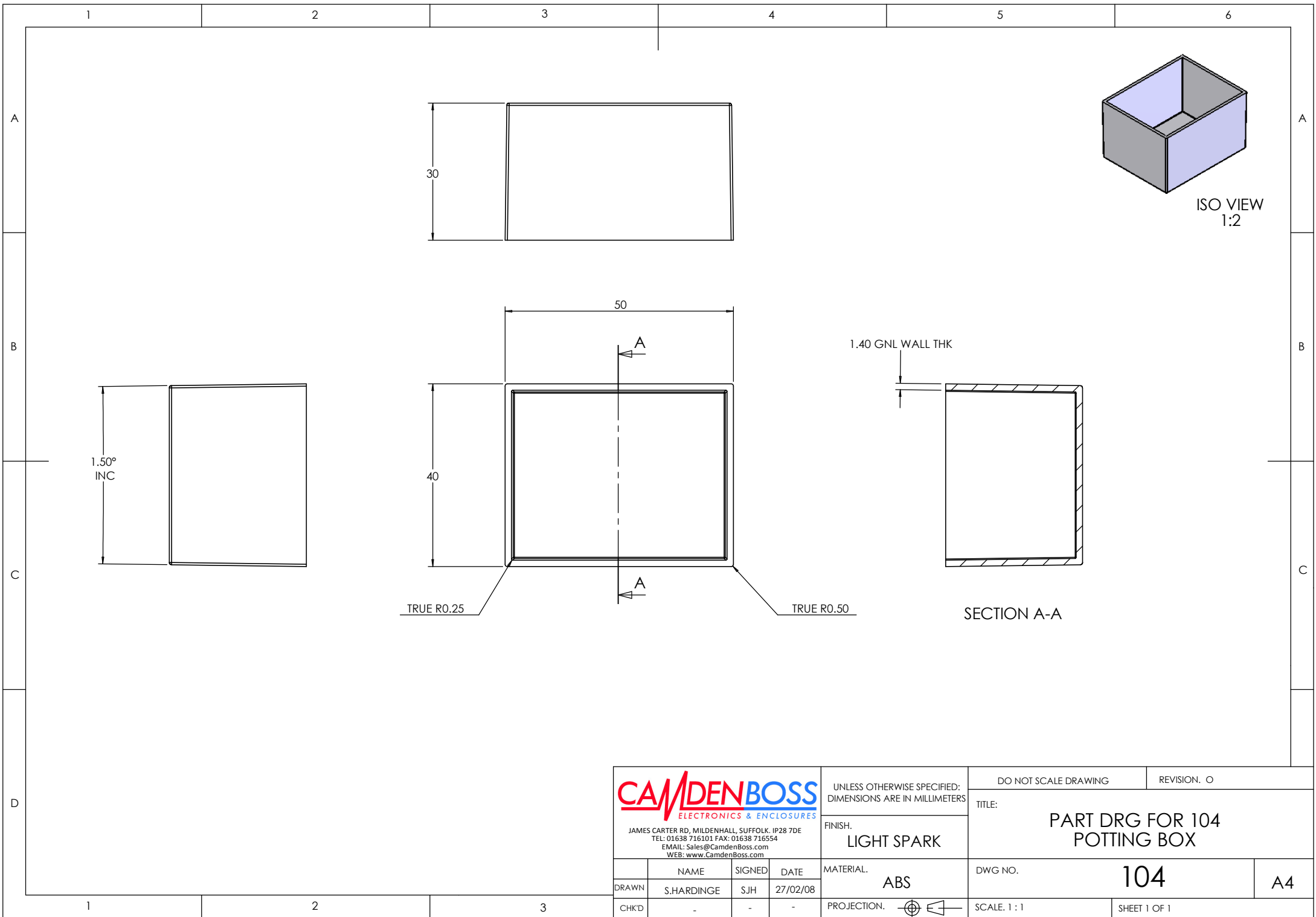

CAMDENBOSS
 ELECTRONICS & ENCLOSURES
 JAMES CARTER RD, MILDENHALL, SUFFOLK. IP28 7DE
 TEL: 01638 716101 FAX: 01638 716554
 EMAIL: Sales@CamdenBoss.com
 WEB: www.CamdenBoss.com

UNLESS OTHERWISE SPECIFIED:
 DIMENSIONS ARE IN MILLIMETERS

FINISH:
 LIGHT SPARK

MATERIAL:
 ABS

PROJECTION:

DO NOT SCALE DRAWING

REVISION: 0

TITLE:
 PART DRG FOR 104
 POTTING BOX

DWG NO. 104

A4

	NAME	SIGNED	DATE
DRAWN	S.HARDINGE	SJH	27/02/08
CHK'D	-	-	-

SCALE: 1 : 1

SHEET 1 OF 1

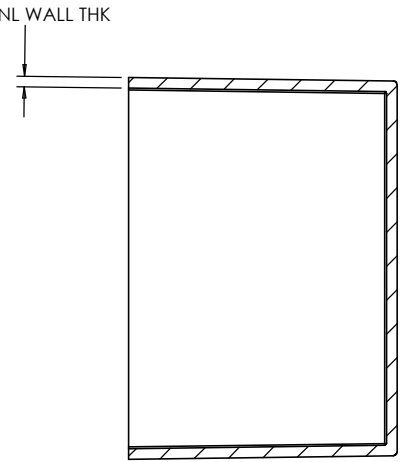
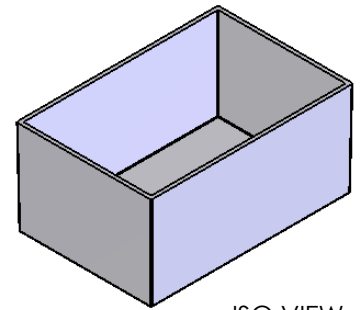
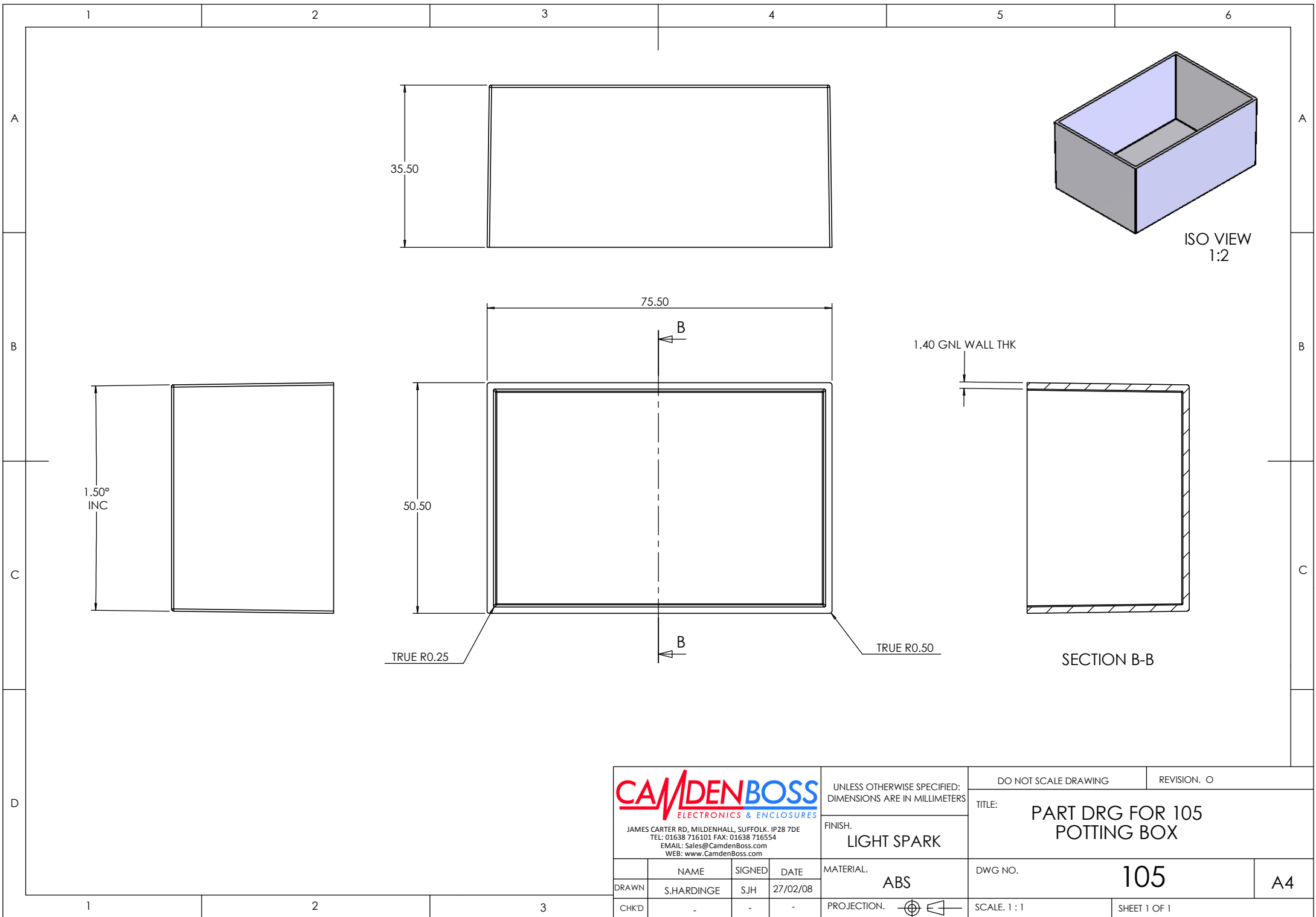

<p>CAMDENBOSS ELECTRONICS & ENCLOSURES</p> <p>JAMES CARTER RD, MILDENHALL, SUFFOLK. IP28 7DE TEL: 01638 716101 FAX: 01638 716554 EMAIL: Sales@CamdenBoss.com WEB: www.CamdenBoss.com</p>				UNLESS OTHERWISE SPECIFIED: DIMENSIONS ARE IN MILLIMETERS		DO NOT SCALE DRAWING		REVISION. O	
				FINISH. LIGHT SPARK		TITLE: PART DRG FOR 105 POTTING BOX			
DRAWN		NAME	SIGNED	DATE	MATERIAL.		DWG NO.		A4
CHK'D		S.HARDINGE	SJH	27/02/08	ABS		105		
					PROJECTION.		SCALE. 1 : 1		SHEET 1 OF 1

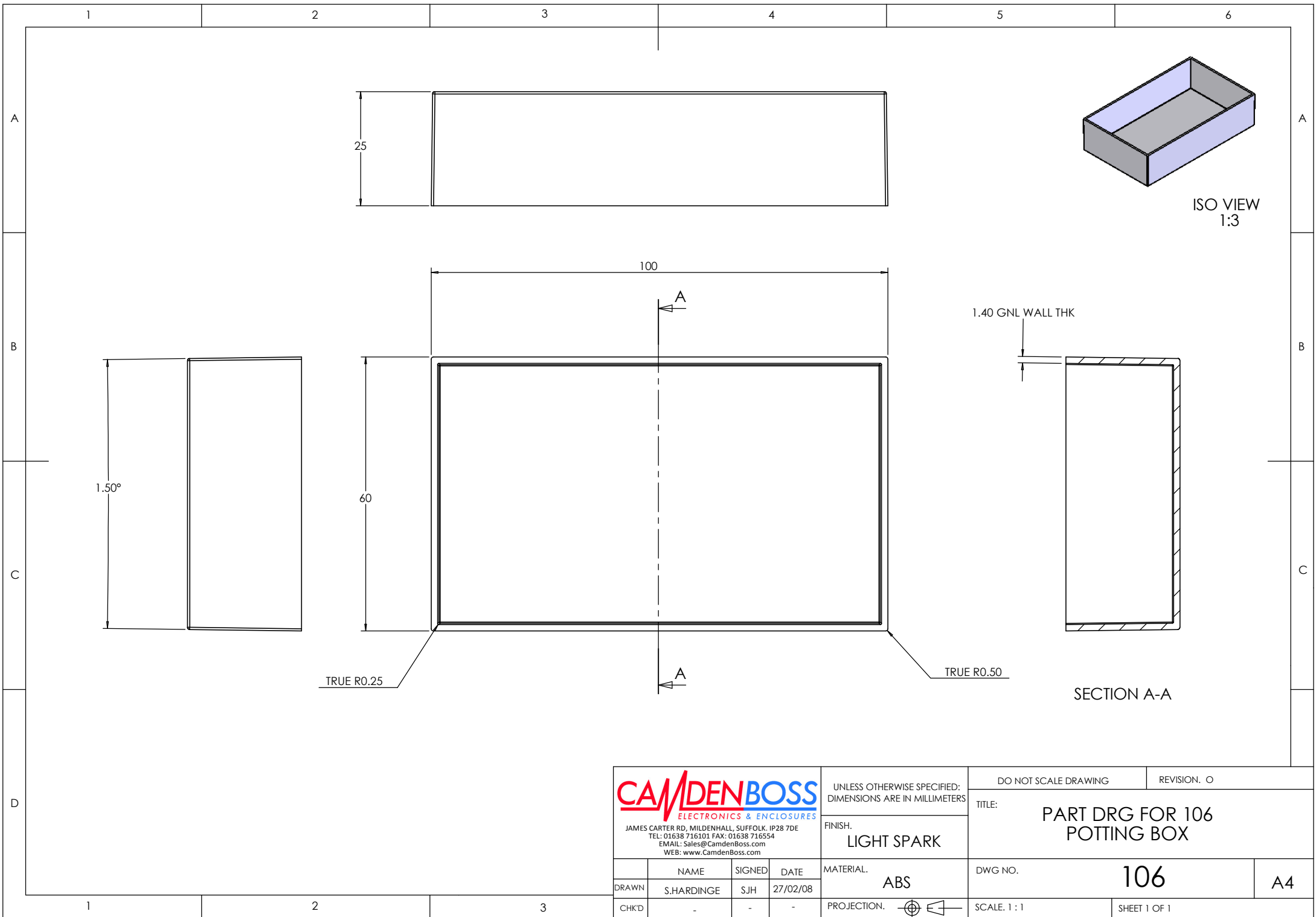

CAMDENBOSS
 ELECTRONICS & ENCLOSURES
 JAMES CARTER RD, MILDENHALL, SUFFOLK. IP28 7DE
 TEL: 01638 716101 FAX: 01638 716554
 EMAIL: Sales@CamdenBoss.com
 WEB: www.CamdenBoss.com

UNLESS OTHERWISE SPECIFIED:
 DIMENSIONS ARE IN MILLIMETERS

FINISH:
 LIGHT SPARK

MATERIAL:
 ABS

PROJECTION.

DO NOT SCALE DRAWING		REVISION. 0	
TITLE: PART DRG FOR 106 POTTING BOX			
DWG NO. 106		A4	
SCALE: 1 : 1		SHEET 1 OF 1	

	NAME	SIGNED	DATE
DRAWN	S.HARDINGE	SJH	27/02/08
CHK'D	-	-	-

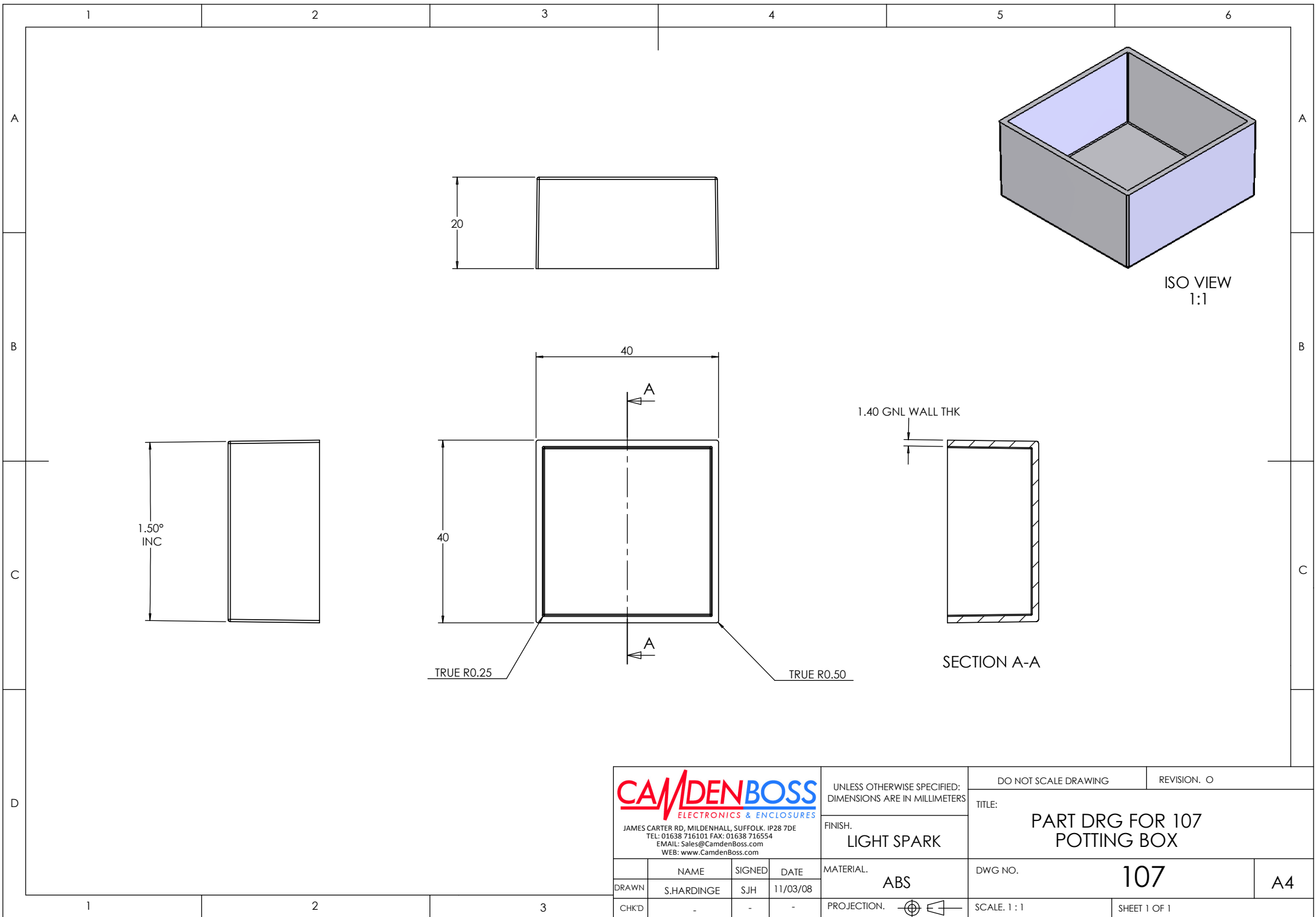

CAMDENBOSS
 ELECTRONICS & ENCLOSURES
 JAMES CARTER RD, MILDENHALL, SUFFOLK. IP28 7DE
 TEL: 01638 716101 FAX: 01638 716554
 EMAIL: Sales@CamdenBoss.com
 WEB: www.CamdenBoss.com

UNLESS OTHERWISE SPECIFIED:
 DIMENSIONS ARE IN MILLIMETERS

FINISH:
 LIGHT SPARK

MATERIAL:
 ABS

PROJECTION.

DO NOT SCALE DRAWING		REVISION. 0	
TITLE: PART DRG FOR 107 POTTING BOX			
DWG NO.		107	
SCALE. 1 : 1		SHEET 1 OF 1	

	NAME	SIGNED	DATE
DRAWN	S.HARDINGE	SJH	11/03/08
CHK'D	-	-	-

A4

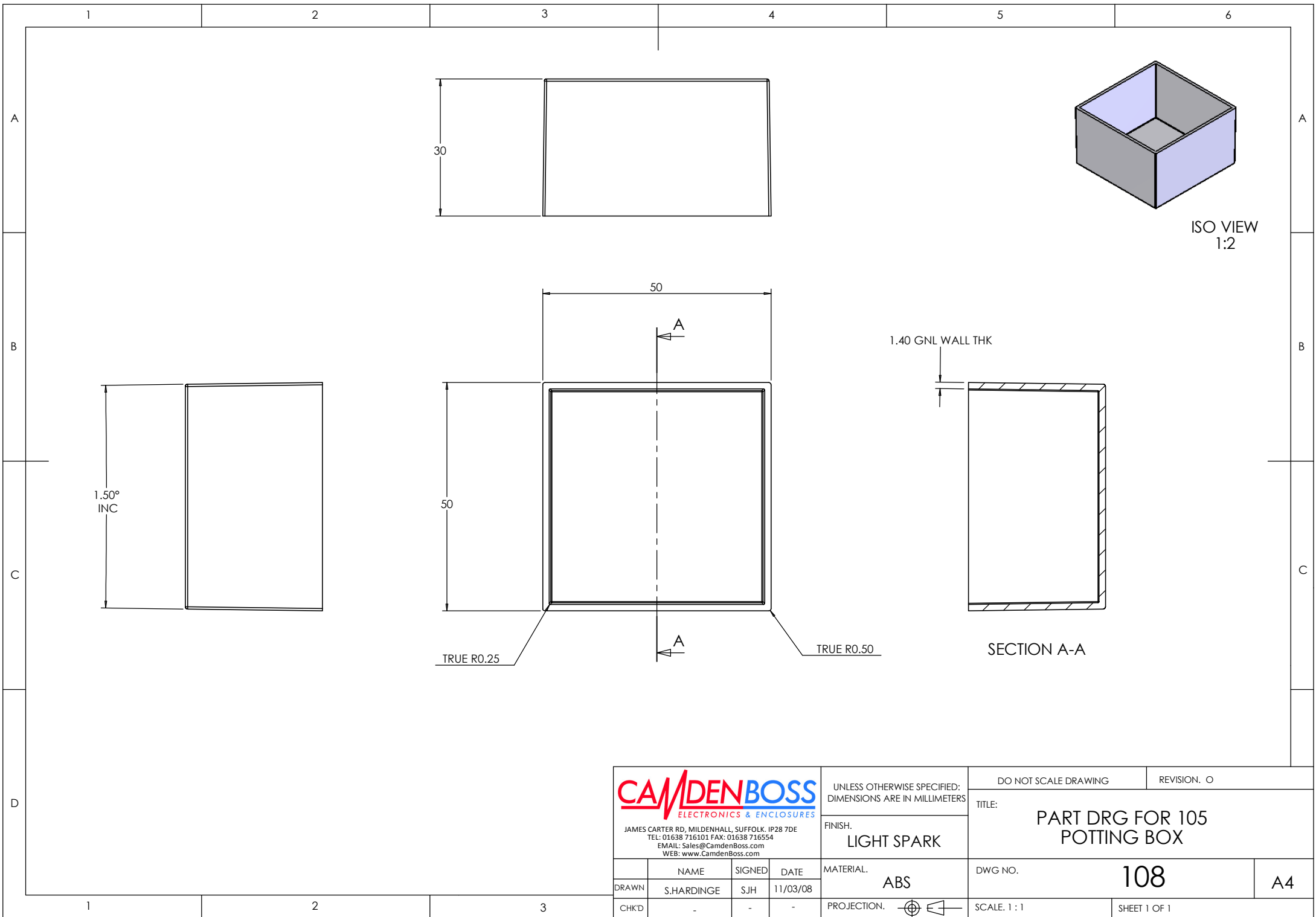

<p>JAMES CARTER RD, MILDENHALL, SUFFOLK IP28 7DE TEL: 01638 716101 FAX: 01638 716554 EMAIL: Sales@CamdenBoss.com WEB: www.CamdenBoss.com</p>				UNLESS OTHERWISE SPECIFIED: DIMENSIONS ARE IN MILLIMETERS		DO NOT SCALE DRAWING		REVISION. O	
				FINISH. LIGHT SPARK		TITLE: PART DRG FOR 105 POTTING BOX			
DRAWN S.HARDINGE		SIGNED SJH	DATE 11/03/08	MATERIAL. ABS		DWG NO. 108		A4	
CHK'D -		-	-	PROJECTION.		SCALE. 1 : 1		SHEET 1 OF 1	

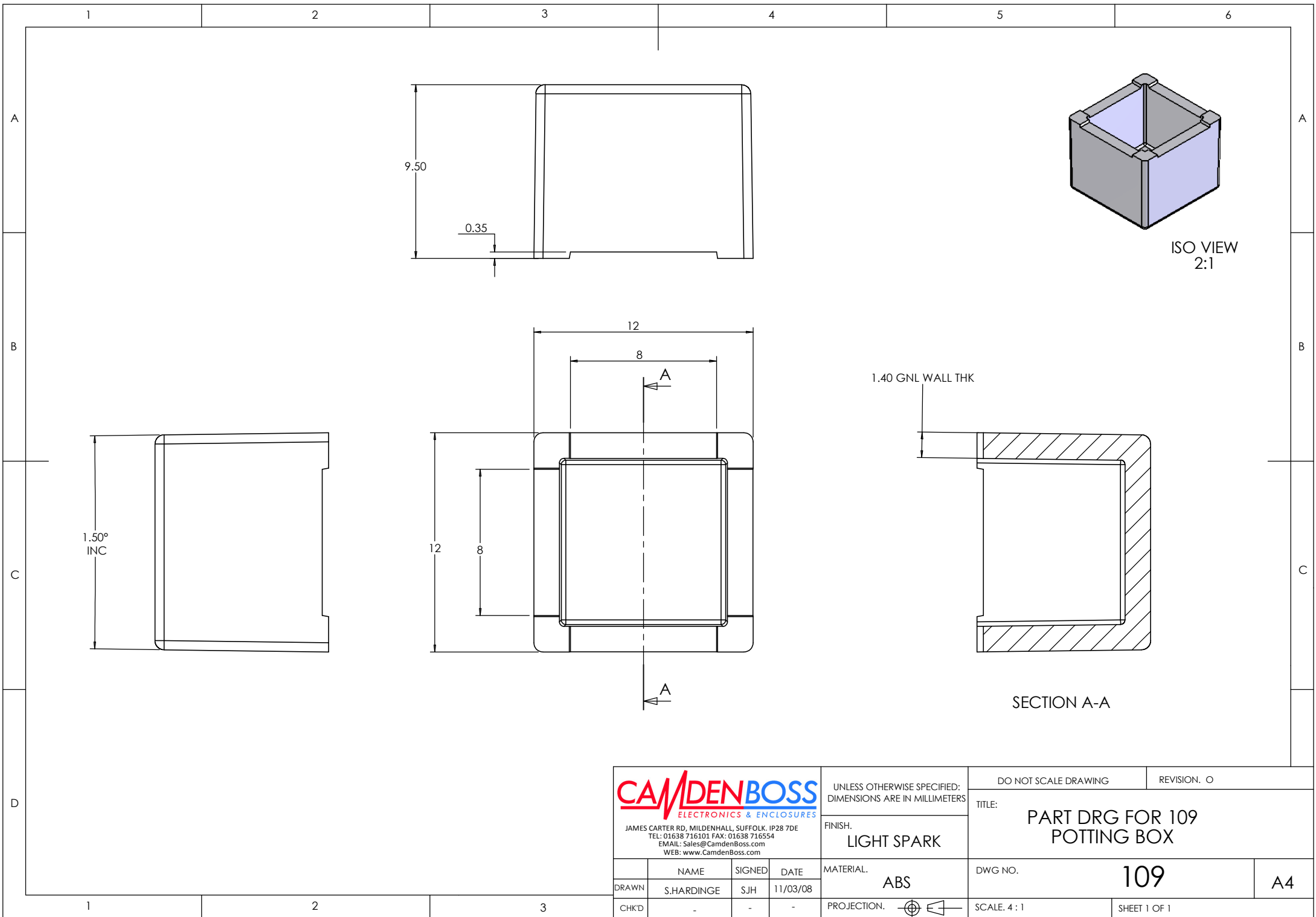

 CAMDENBOSS ELECTRONICS & ENCLOSURES JAMES CARTER RD, MILDENHALL, SUFFOLK. IP28 7DE TEL: 01638 716101 FAX: 01638 716554 EMAIL: Sales@CamdenBoss.com WEB: www.CamdenBoss.com				UNLESS OTHERWISE SPECIFIED: DIMENSIONS ARE IN MILLIMETERS		DO NOT SCALE DRAWING		REVISION. O		
				FINISH. LIGHT SPARK		TITLE: PART DRG FOR 109 POTTING BOX				
DRAWN S.HARDINGE		SIGNED SJH		DATE 11/03/08		MATERIAL. ABS		DWG NO. 109		A4
CHK'D -		-		-		PROJECTION.		SCALE. 4 : 1		SHEET 1 OF 1

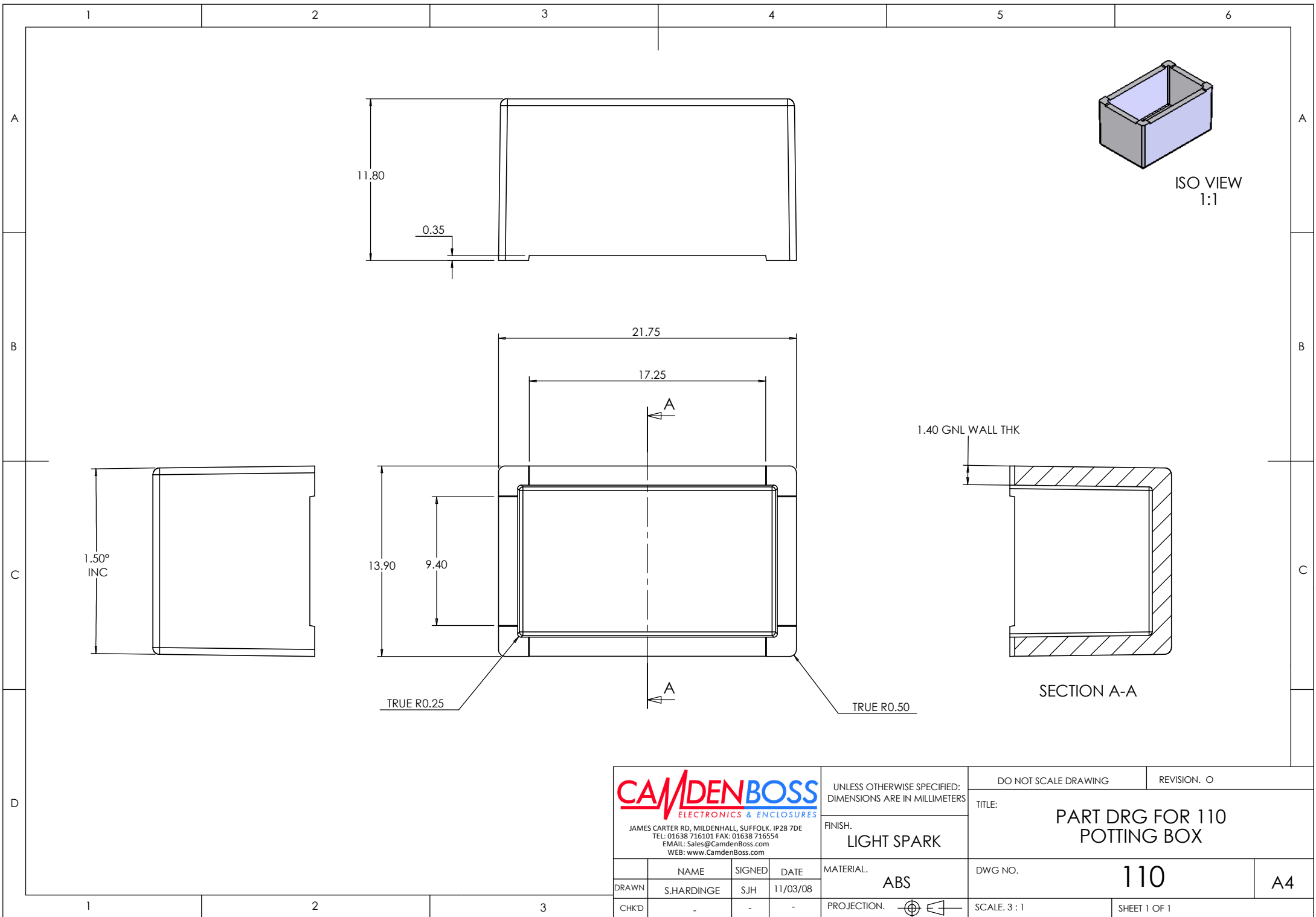

CAMDENBOSS
 ELECTRONICS & ENCLOSURES
 JAMES CARTER RD, MILDENHALL, SUFFOLK. IP28 7DE
 TEL: 01638 716101 FAX: 01638 716554
 EMAIL: Sales@CamdenBoss.com
 WEB: www.CamdenBoss.com

UNLESS OTHERWISE SPECIFIED:
 DIMENSIONS ARE IN MILLIMETERS

FINISH:
LIGHT SPARK

DO NOT SCALE DRAWING REVISION. 0

TITLE:
**PART DRG FOR 110
 POTTING BOX**

	NAME	SIGNED	DATE
DRAWN	S.HARDINGE	SJH	11/03/08
CHK'D	-	-	-

MATERIAL:
ABS

PROJECTION.

DWG NO. **110** A4

SCALE: 3 : 1 SHEET 1 OF 1

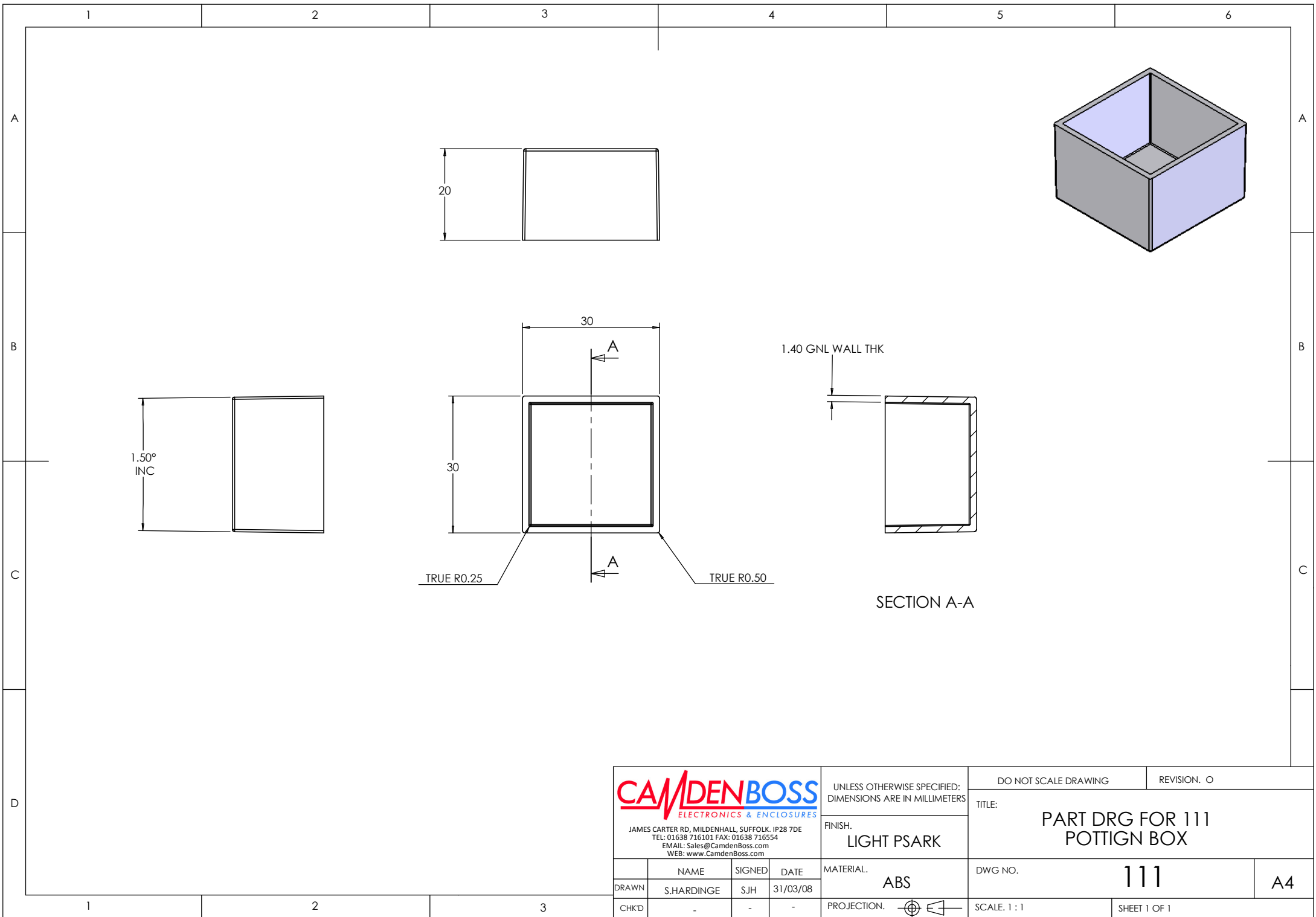

SECTION A-A

 CAMDENBOSS ELECTRONICS & ENCLOSURES JAMES CARTER RD, MILDENHALL, SUFFOLK. IP28 7DE TEL: 01638 716101 FAX: 01638 716554 EMAIL: Sales@CamdenBoss.com WEB: www.CamdenBoss.com				UNLESS OTHERWISE SPECIFIED: DIMENSIONS ARE IN MILLIMETERS		DO NOT SCALE DRAWING		REVISION. O		
				FINISH. LIGHT PSARK		TITLE: PART DRG FOR 111 POTTIGN BOX				
DRAWN S.HARDINGE		SIGNED SJH		DATE 31/03/08		MATERIAL. ABS		DWG NO. 111		A4
CHK'D -		-		-		PROJECTION.		SCALE. 1 : 1		SHEET 1 OF 1

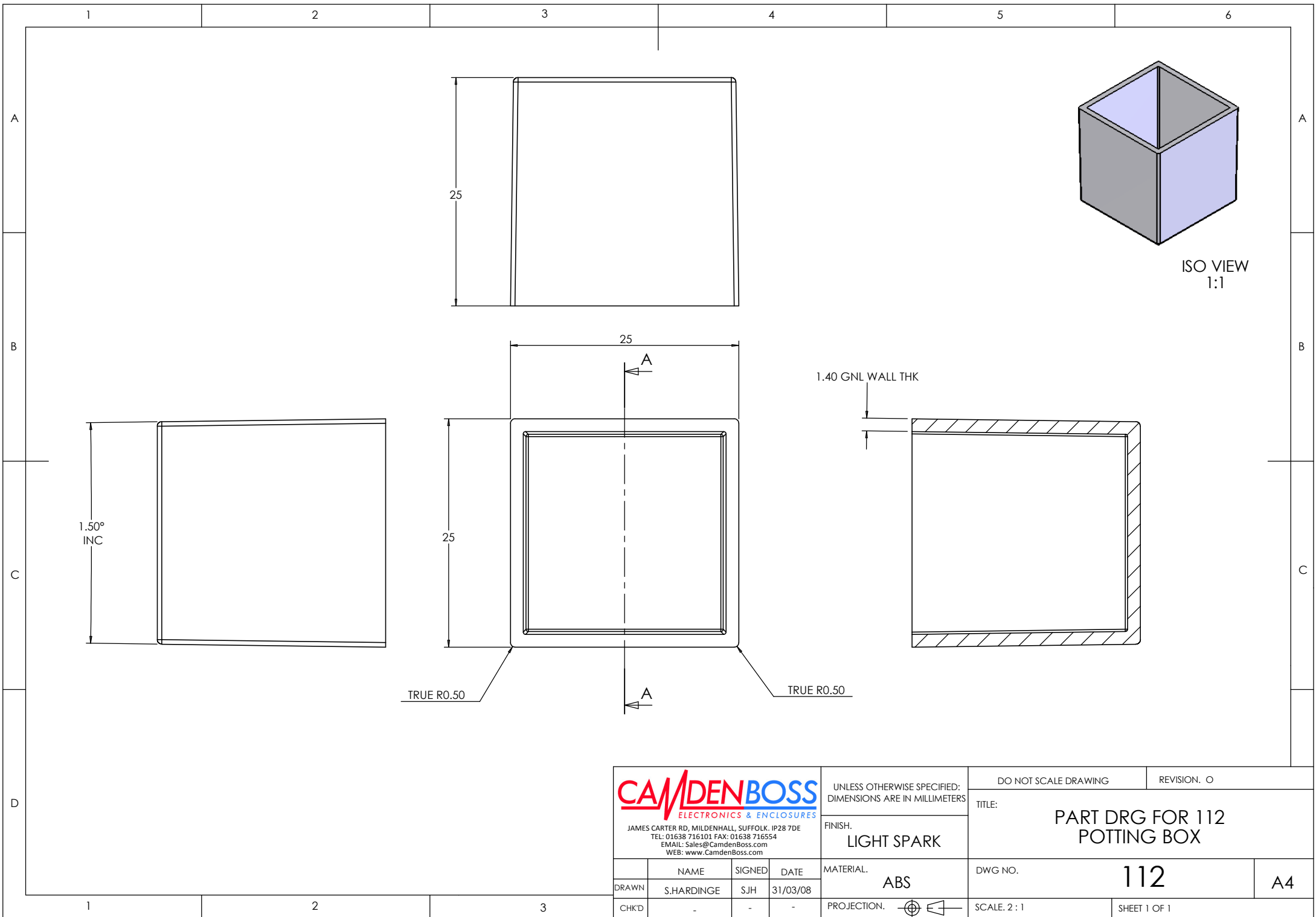

CAMDENBOSS
 ELECTRONICS & ENCLOSURES
 JAMES CARTER RD, MILDENHALL, SUFFOLK, IP28 7DE
 TEL: 01638 716101 FAX: 01638 716554
 EMAIL: Sales@CamdenBoss.com
 WEB: www.CamdenBoss.com

UNLESS OTHERWISE SPECIFIED:
 DIMENSIONS ARE IN MILLIMETERS

FINISH:
 LIGHT SPARK

DO NOT SCALE DRAWING REVISION. 0

TITLE: **PART DRG FOR 112
 POTTING BOX**

	NAME	SIGNED	DATE
DRAWN	S.HARDINGE	SJH	31/03/08
CHK'D	-	-	-

MATERIAL:
ABS

PROJECTION.

DWG NO. **112** A4

SCALE: 2 : 1 SHEET 1 OF 1

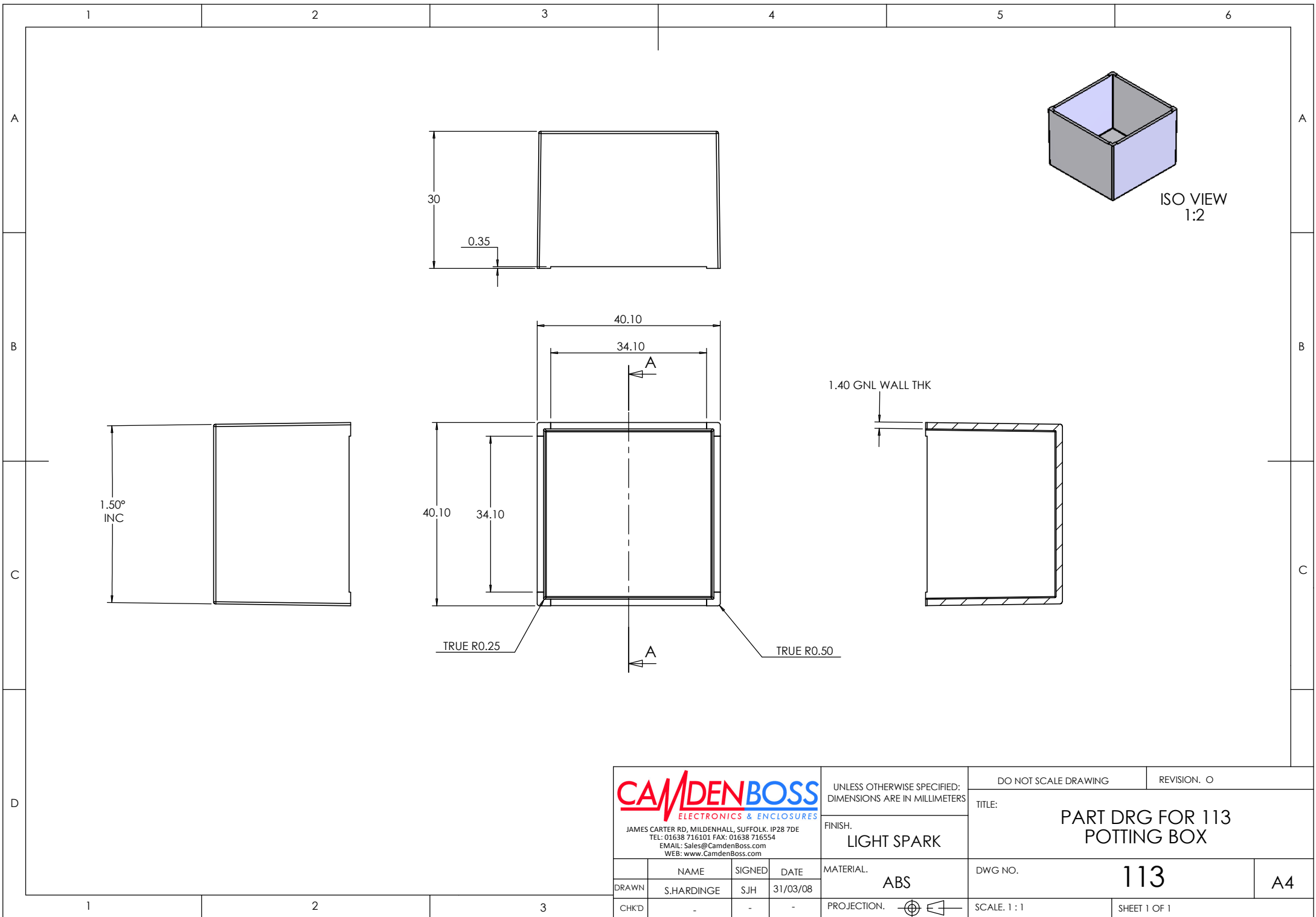

1.50°
INC

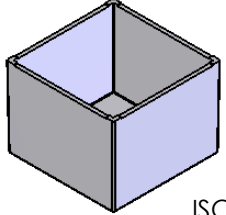
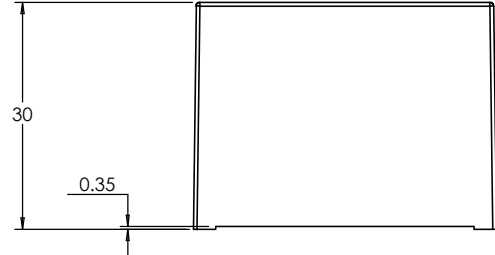

ISO VIEW
1:2

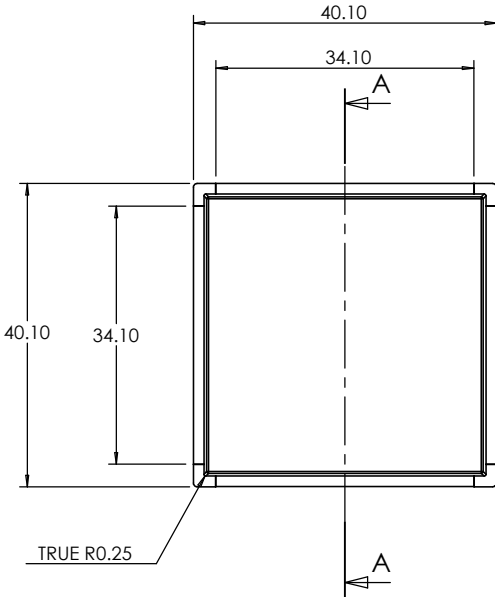

1.40 GNL WALL THK

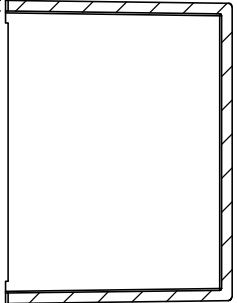

CAMDENBOSS
ELECTRONICS & ENCLOSURES

JAMES CARTER RD, MILDENHALL, SUFFOLK. IP28 7DE
TEL: 01638 716101 FAX: 01638 716554
EMAIL: Sales@CamdenBoss.com
WEB: www.CamdenBoss.com

UNLESS OTHERWISE SPECIFIED:
DIMENSIONS ARE IN MILLIMETERS

FINISH:
LIGHT SPARK

DO NOT SCALE DRAWING REVISION. 0

TITLE: **PART DRG FOR 113
POTTING BOX**

	NAME	SIGNED	DATE
DRAWN	S.HARDINGE	SJH	31/03/08
CHK'D	-	-	-

MATERIAL:
ABS

PROJECTION.

DWG NO. **113** A4

SCALE: 1 : 1 SHEET 1 OF 1

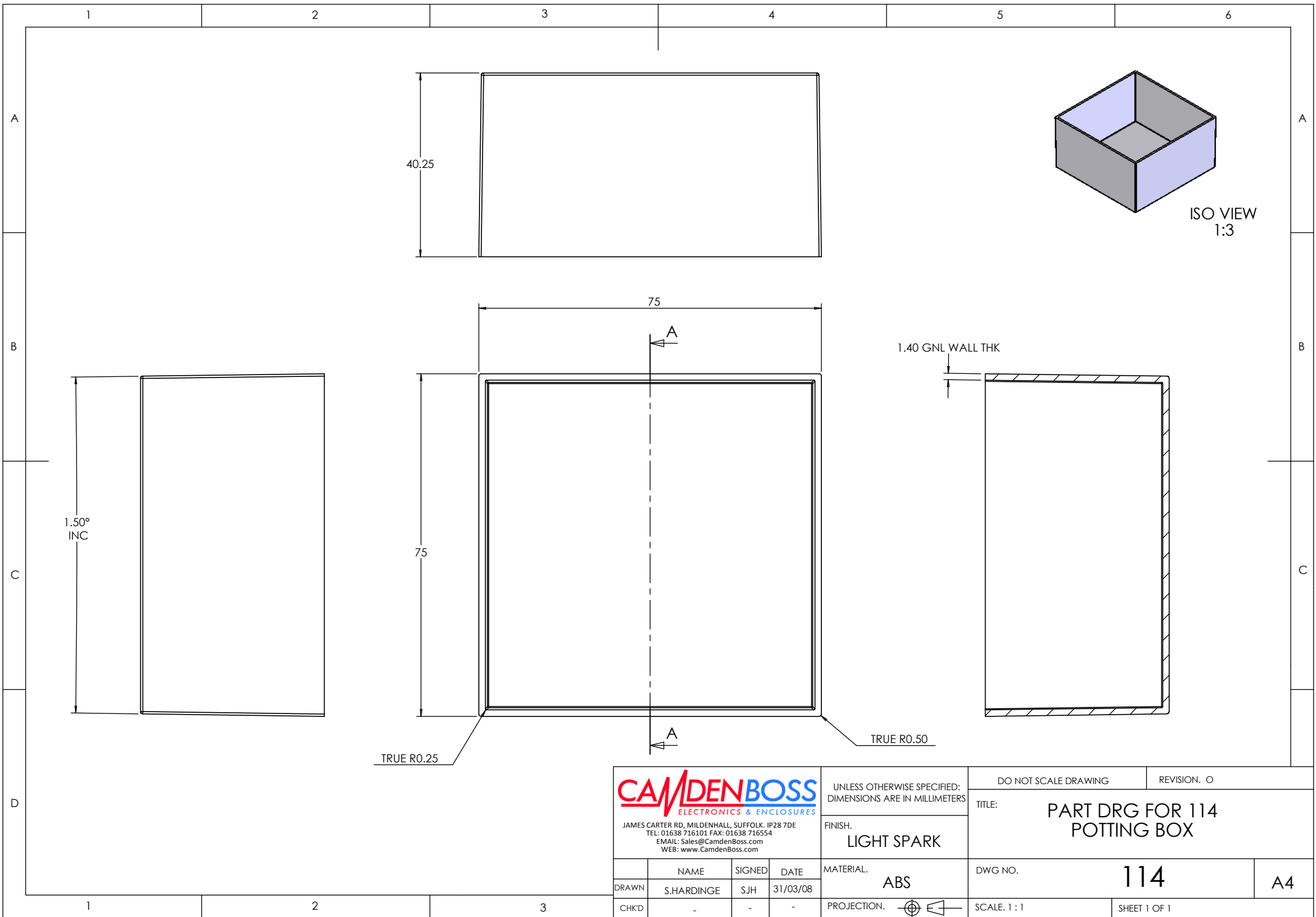

CAMDENBOSS
 ELECTRONICS & ENCLOSURES
 JAMES CARTER RD, MILDENHALL, SUFFOLK. IP28 7DE
 TEL: 01638 716101 FAX: 01638 716554
 EMAIL: Sales@CamdenBoss.com
 WEB: www.CamdenBoss.com

UNLESS OTHERWISE SPECIFIED:
 DIMENSIONS ARE IN MILLIMETERS

FINISH:
LIGHT SPARK

DO NOT SCALE DRAWING REVISION. 0

TITLE: **PART DRG FOR 114
 POTTING BOX**

	NAME	SIGNED	DATE
DRAWN	S.HARDINGE	SJH	31/03/08
CHK'D	-	-	-

MATERIAL:
ABS

PROJECTION.

DWG NO. **114** A4

SCALE: 1 : 1 SHEET 1 OF 1

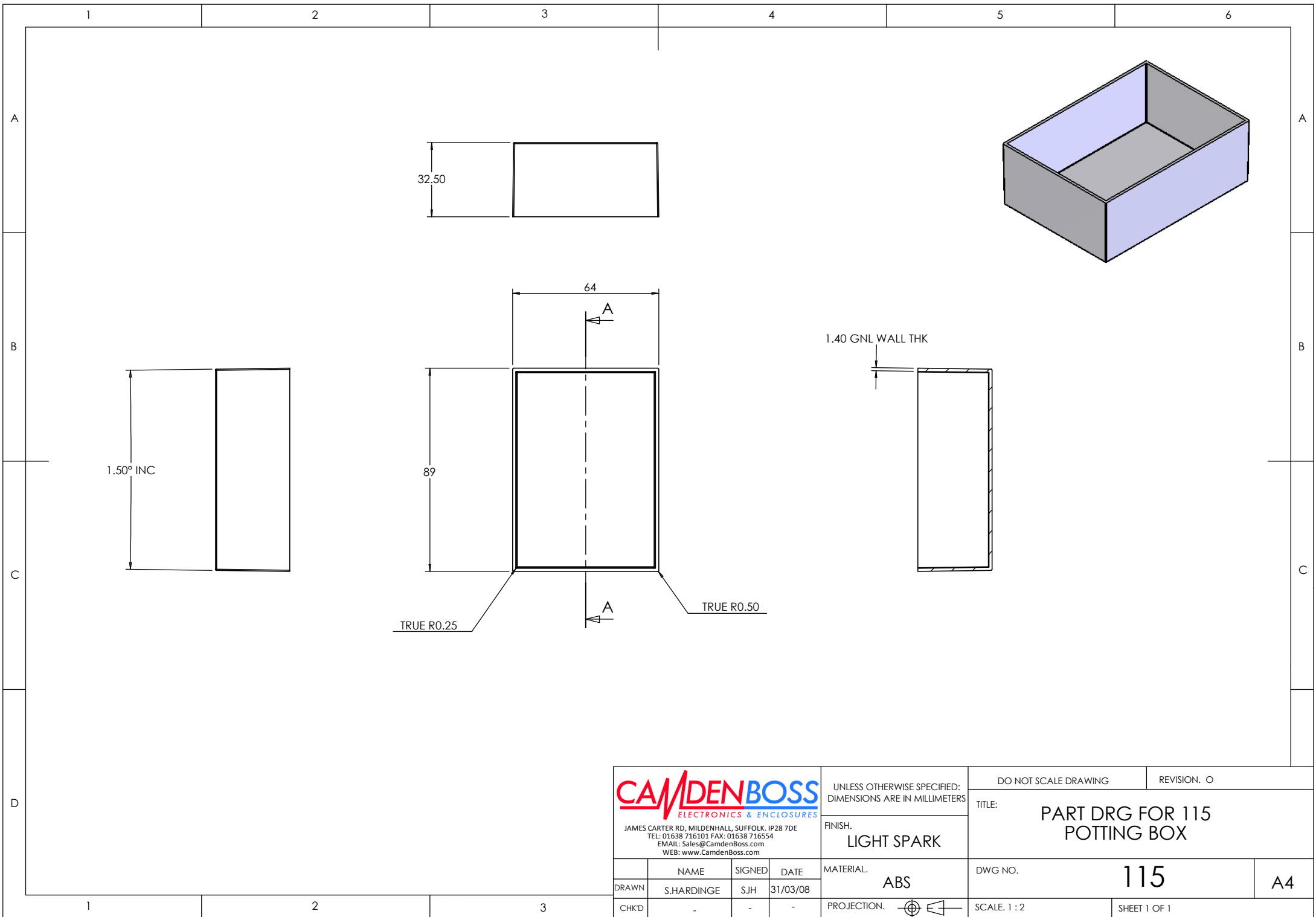

CAMDENBOSS
 ELECTRONICS & ENCLOSURES
 JAMES CARTER RD, MILDENHALL, SUFFOLK. IP28 7DE
 TEL: 01638 716101 FAX: 01638 716554
 EMAIL: Sales@CamdenBoss.com
 WEB: www.CamdenBoss.com

UNLESS OTHERWISE SPECIFIED:
 DIMENSIONS ARE IN MILLIMETERS

FINISH:
 LIGHT SPARK

DO NOT SCALE DRAWING REVISION. 0

TITLE: **PART DRG FOR 115 POTTING BOX**

	NAME	SIGNED	DATE
DRAWN	S.HARDINGE	SJH	31/03/08
CHK'D	-	-	-

MATERIAL:
ABS

PROJECTION.

DWG NO. **115** **A4**

SCALE: 1 : 2 SHEET 1 OF 1

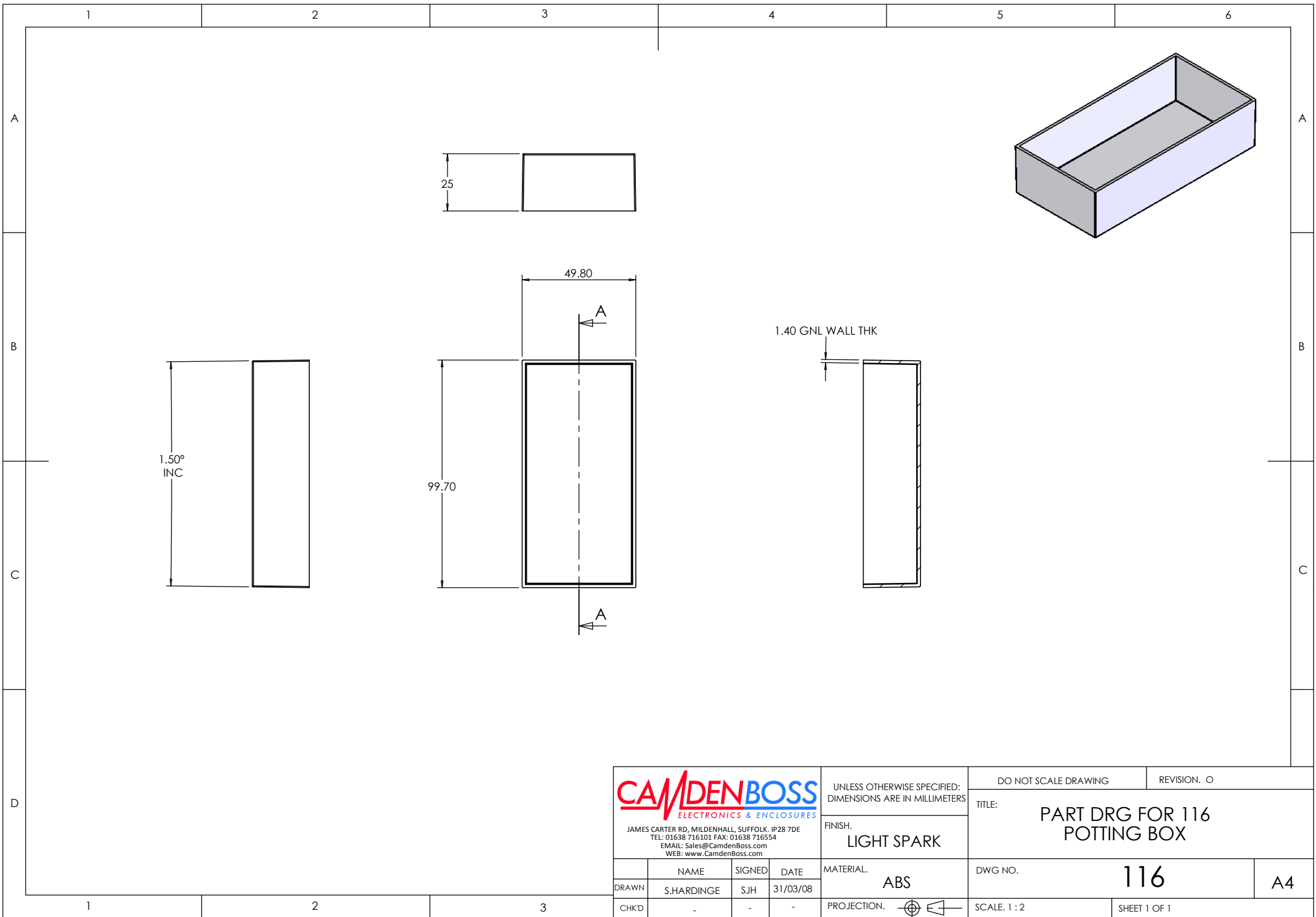

<p>JAMES CARTER RD, MILDENHALL, SUFFOLK. IP28 7DE TEL: 01638 716101 FAX: 01638 716554 EMAIL: Sales@CamdenBoss.com WEB: www.CamdenBoss.com</p>				UNLESS OTHERWISE SPECIFIED: DIMENSIONS ARE IN MILLIMETERS		DO NOT SCALE DRAWING		REVISION. 0	
				FINISH. LIGHT SPARK		TITLE: PART DRG FOR 116 POTTING BOX			
DRAWN		NAME	SIGNED	DATE	MATERIAL.		DWG NO.		A4
CHK'D		S.HARDINGE	SJH	31/03/08	ABS		116		
					PROJECTION.		SCALE. 1 : 2		SHEET 1 OF 1