

TP-LINK®

The Reliable Choice

Installation Guide

Outdoor CPE

CPE210 / CPE220 / CPE510 / CPE520

CONTENTS

Overview	1
Hardware Connection	
Site Consideration	3
Connection and Installation	5
Lightning & ESD Protection	6
Software Configuration	
Logging into the PharOS	8
Configuration for Typical Applications	11
• Point-to-Point	11
• Point-to-Multipoint	13
• Hotspot	15
Antenna Alignment	17
Specifications	18
FAQ (Frequently Asked Questions)	19

Overview

TP-LINK's Pharos series outdoor CPEs are dedicated to outdoor wireless network solutions. This guide is applicable to products including CPE210, CPE220, CPE510 and CPE520.

• Package Contents

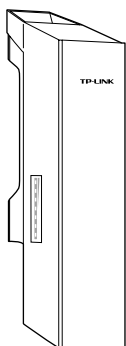

Pharos CPE



Passive PoE Adapter



Power Cord



Pole Mounting Straps



Installation Guide

• LED Explanation

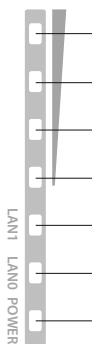

AP/AP Router mode:

All four LEDs remain solid.

Client/Bridge/Repeater/AP Client Router mode:

That the more LEDs lit will indicate better wireless signal strength.

On: A device is connected to this port, but there is no activity.

Flashing: A device is connected to this port, and is active.

On: The CPE is powered on.

• Panel Layout

Pharos CPE:

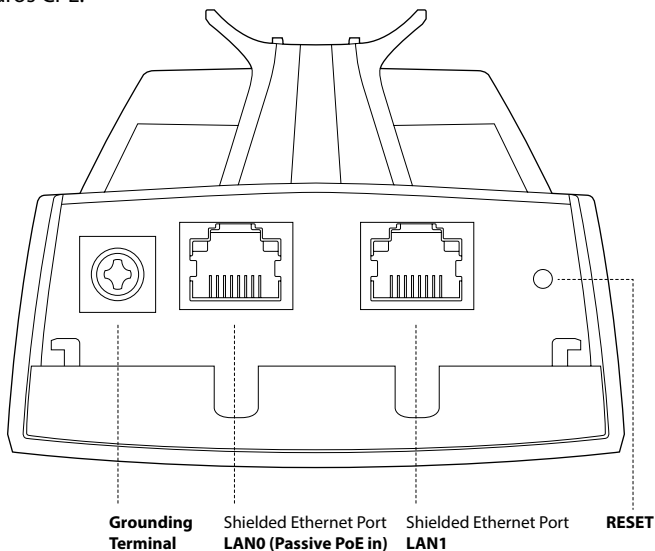

Passive PoE Adapter:

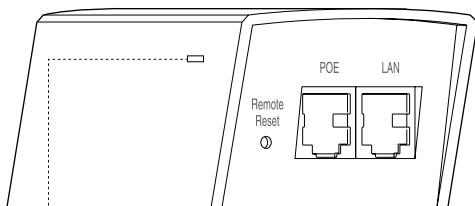

Power LED
The Power LED indicates the status of the electric current: green (0~0.8A), red (0.8A~1A).

Hardware Connection

1. Site Consideration

- **Mounting Height**

Ensure a clear line of sight between the wireless devices for an optimum performance. An elevated location is recommended as obstacles like trees, buildings and large steel structures will weaken the wireless signal.

See 'Q2' in 'FAQ' for details about how to calculate the minimum mounting height of the devices.

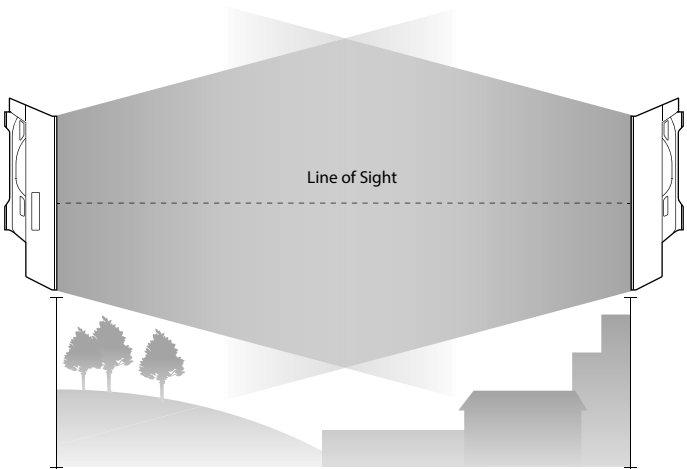

Side View

• Orientation

Install the CPE devices with the front facing the intended signal receiving devices. You can orient the devices with the assistance of Google Maps, GPS and some landmarks according to the horizontal beamwidth listed below.

Models	CPE210	CPE220	CPE510	CPE520
Horizontal Beamwidth	70°	45°	45°	50°

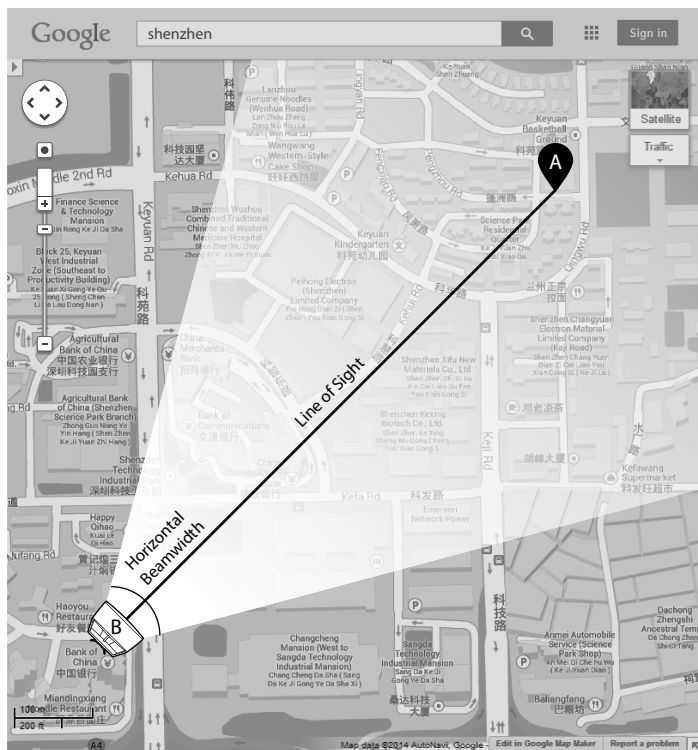

2. Connection and Installation

Please connect and install the device as shown in the figure below.

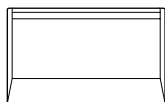
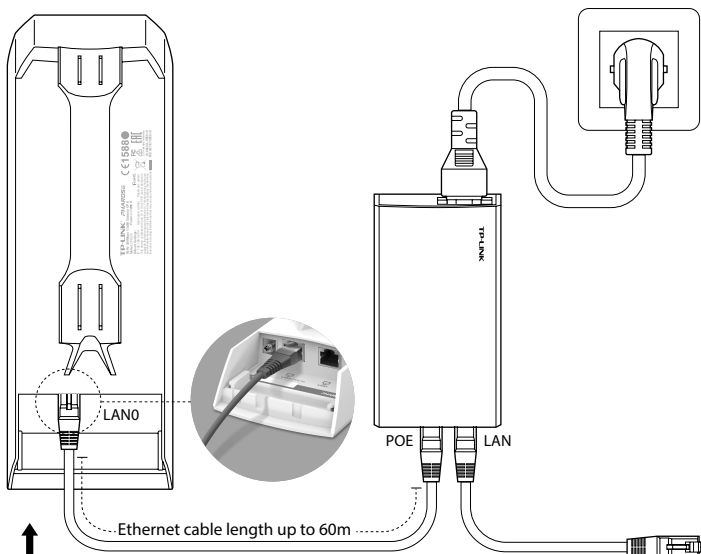

Slide to replace the cover of the CPE when all connections are finished.

You should prepare an adequate Ethernet cable to connect the CPE and the passive PoE adapter. Shielded CAT5e (or above) cable with ground wire is recommended (refer to the next section).

Connect to a computer, router or switch. (Depending on your intended usage and/or network topology.)

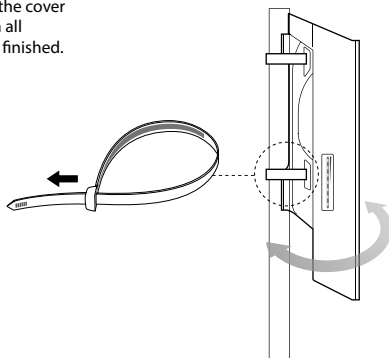

At the selected site, approximately align the CPE to the direction that you have oriented.

3. Lightning & ESD Protection

Proper grounding is extremely important for outdoor devices. By using shielded CAT5e (or above) cable with ground wire for the connection and the provided PoE adapter (method ①), you can effectively eliminate ESD attacks. If you use the general CAT5e cable for the connection, then it is necessary to connect the grounding terminal of the CPE to earth ground through grounding cable (method ②).

Two Methods:

- ① Shielded CAT5e (or above) Cable with Ground Wire
- ② Grounding Terminal and Cable

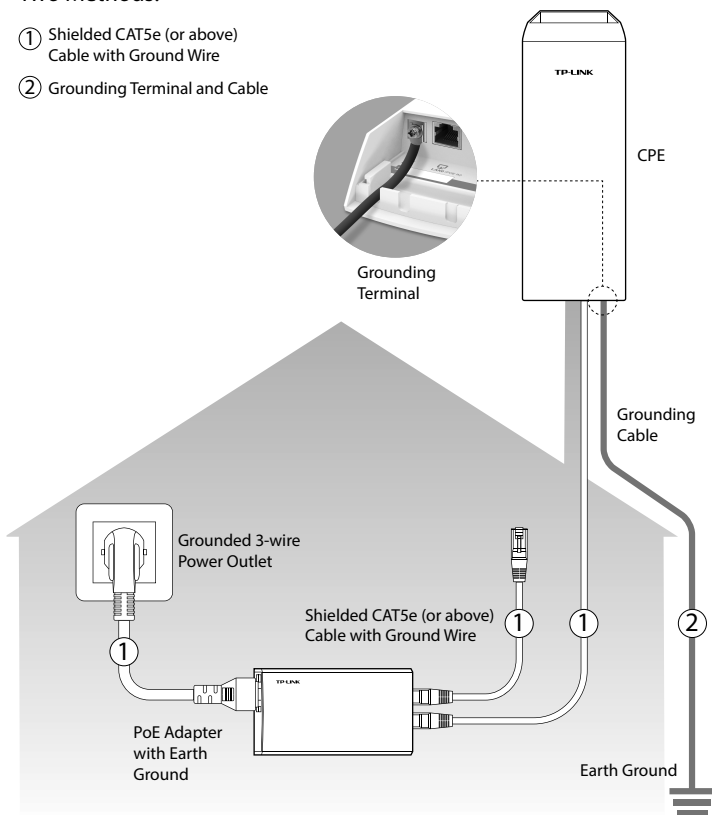

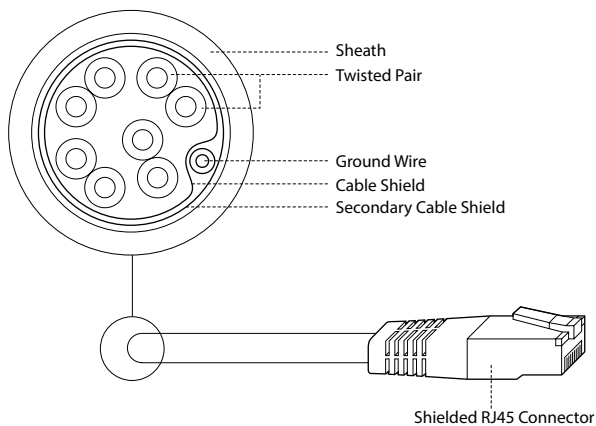

Shielded CAT5e (or above) Cable with Ground Wire

Software Configuration

This chapter introduces the login to the PharOS Web Interface and the software configurations to implement three typical applications, including point-to-point, point-to-multipoint and hotspot.

1. Logging into the PharOS

1. Before accessing the PharOS Web Interface, you need to assign a static IP address $192.168.0.x$ ($2 \leq x \leq 253$) to your computer. We use $192.168.0.10$ as an example in the figure below.

General

You can get IP settings assigned automatically if your network supports this capability. Otherwise, you need to ask your network administrator for the appropriate IP settings.

Obtain an IP address automatically

Use the following IP address:

IP address:

Subnet mask:

Default gateway:

Obtain DNS server address automatically

Use the following DNS server addresses:

Preferred DNS server:

Alternate DNS server:

Validate settings upon exit

Advanced...

OK Cancel

- Open your web browser, type 'http://192.168.0.254' in the address field and press 'Enter'. It is recommended to use the latest version of Google Chrome, Safari or Firefox.



- The 'Login' page will appear, set the parameters as below.
 - Username: admin.
 - Password: admin.
 - Region: select according to your country/region.
 - Select 'I agree to these terms of use'.
 - Click 'Login'!

A screenshot of the TP-LINK login page. The page has a grey header with the word 'Login' on the left. The main content area is white and features the TP-LINK logo (The Reliable Choice) on the left. On the right, there are three input fields: 'User Name' with 'admin' entered, 'Password' with six dots, and 'Region' with a dropdown arrow. Below these is a 'TERMS OF USE' section with a text box containing legal disclaimer text and a link to 'www.tp-link.com'. At the bottom left, there is a checked checkbox 'I agree to these terms of use'. At the bottom right, there are two buttons: 'Login' and 'Clear'.

- At the first login, change the 'Password' for safety.

A screenshot of the TP-LINK 'Change Password' page. The page has a grey header with the text 'Change Password'. The main content area is white and features the TP-LINK logo (The Reliable Choice) on the left. On the right, there are three input fields: 'New User Name' with 'admin' entered, 'New Password', and 'Confirm Password'. Below these is a text box with the message: 'It is recommended to change the device user name and password from its default settings.' At the bottom right, there are two buttons: 'Finish' and 'Clear'.

For subsequent logins, you only need to enter the username and password that you have set to log in.

- Then you will log in to the PharOS Web Interface and see the Status page as shown in the figure below.

TP-LINK PHAROS
About Support Log Out

Operation Mode: Access Point Tools

QUICK SETUP
STATUS
NETWORK
WIRELESS
MANAGEMENT
SYSTEM

Device Information

Device Name: CPE510
 Device Model: CPE510 v1.0
 Firmware Version: 1.0.0 Build 20140126 Rel. 49382
 System Time: 2014-01-01 00:03:14
 Uptime: 0 days 00:03:15
 CPU: 1%
 Memory: 49%

Wireless Settings

MAXstream: OFF
 Region: Test_Mode
 Channel/Frequency: 132 / 5660MHz
 Channel Width: 20/40MHz
 IEEE802.11 Mode: AN Mixed
 Max TX Rate: 300.0Mbps
 Transmit Power: 27dBm
 Distance: 0.0km

Wireless Signal Quality

Signal Strength: N/A
 Noise Strength: N/A
 SNR: N/A
 Transmit CQO: 100

Radio Status

AP: Enabled
 MAC Address: E0-05-C5-86-A3-F1
 SSID: TP-LINK_Outdoor_86A3F1
 Security Mode: None
 Connected Stations: 0

LAN

MAC Address: E0-05-C5-86-A3-F1
 IP Address: 192.168.0.254
 Subnet Mask: 255.255.255.0
 Port0: 100Mbps - FD
 Port1: Unplugged

Client Disabled

MAC Address: N/A
 Security Mode: N/A
 WDS: N/A
 Root AP BSSID: N/A
 Root AP SSID: N/A
 TX Rate: N/A
 RX Rate: N/A
 Connection Time: N/A

WAN

Connection Type: N/A
 MAC Address: N/A
 IP Address: N/A
 Subnet Mask: N/A
 Default Gateway: N/A
 DNS Server: N/A

Monitor

Throughput
Stations
Interfaces
ARP Table
Routes
DHCP Clients

LAN0

WLAN0

— RX: 3Kbps — TX: 4.4Kbps

— RX: 0Kbps — TX: 0Kbps

Copyright © 2014 TP-LINK Technologies Co., Ltd. All rights reserved.

2. Configuration for Typical Applications

This section introduces the configurations for the point-to-point, point-to-multipoint and hotspot applications. Refer to the section corresponding to your networking needs.

• Point-to-Point

Point-to-Point application is used to build a transparent bridge between two locations which are far from each other. The figure shown below is an example for this application.

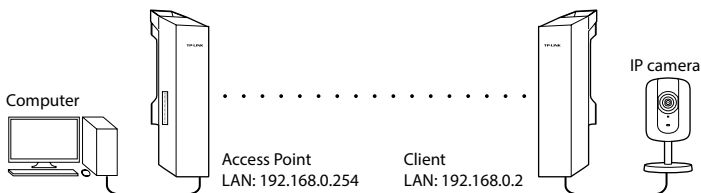

Refer to the following steps to configure the CPEs.

Configure the Access Point

1. Log in to PharOS
2. Go to the Quick Setup page
3. Operation Mode
 - Select 'Access Point'.
 - Click 'Next'.
4. LAN Settings: Click 'Next'.
5. Wireless AP Settings
 - SSID: customize the name for the network as you like.
 - Security: select 'WPA-PSK/WPA2-PSK'.
 - PSK Password: create the password for the network as you like.
 - Distance Setting: enter the distance between the Access Point and the Client. It is recommended to round the number up to the nearest integer.
 - Select the MAXtream option if the Access Point and the Client both are Pharos outdoor CPEs. (Refer to 'Q4' in 'FAQ' for details about MAXtream)
 - Click 'Next'.
6. Finish: Click 'Finish'.

Configure the Client

1. Log in to PharOS

2. Go to the Quick Setup page

3. Operation Mode

- Select 'Client'.
- Click 'Next'.

4. LAN Settings

- IP Address: 192.168.0.2 (in the same subnet with the Access Point)
- Click 'Next'.

5. Wireless Client Settings

- SSID of Remote AP: click 'Survey', select the SSID of the Access Point, and click 'Connect'.
- Security: select 'WPA-PSK/WPA2-PSK'.
- PSK Password: enter the password of the Access Point.
- Distance Setting: enter the same number with the Access Point.
- Click 'Next'.

6. Finish: Click 'Finish'.

• Point-to-Multipoint

Point-to-Multipoint application is used to serve Internet access for multiple locations from a single Access Point. There are many types of configurations to provide this service. Here we introduce the ISP-style (Internet Service Provider along with subscribers) Point-to-Multipoint application, as shown in the figure below.

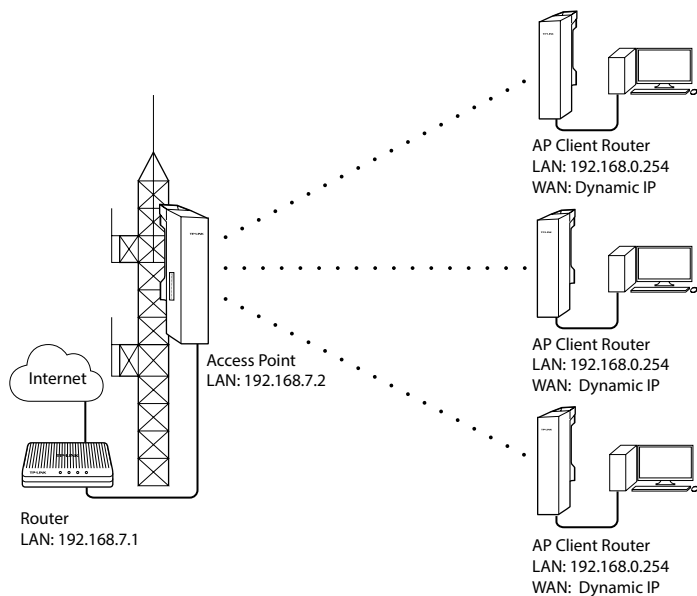

Refer to the following steps to configure the CPEs.



When making the configuration for the CPE of the subscribers, please contact the ISP for related information, as the configuration may vary due to different ISPs.

Configure the Access Point (a typical configuration for Internet Service Provider):

1. Log in to PharOS
2. Go to the Quick Setup page
3. Operation Mode
 - Select 'Access Point'.
 - Click 'Next'.

4. LAN Settings

- IP Address: 192.168.7.2 (in the same subnet with the router).
- Click 'Next'.

5. Wireless AP Settings

- SSID: customize the name for the network as you like.
- Security: select 'WPA-PSK/WPA2-PSK'.
- PSK Password: create the password for the network as you like.
- Distance Setting: enter the distance between the Access Point and the most remote client. It is recommended to round the number up to the nearest integer.
- Select the MAXstream option if the Access Point and the AP Client Routers all are Pharos outdoor CPEs. (Refer to 'Q4' in 'FAQ' for details about MAXstream)
- Click 'Next'.

6. Finish: Click 'Finish'.

Configure the AP Client Router (a typical configuration for subscribers)

1. Log in to PharOS

2. Go to the Quick Setup page

3. Operation Mode

- Select 'AP Client Router(WISP Client)'.
- Click 'Next'.

4. WAN Connection Type

- Select 'Dynamic IP'.
- Click 'Next'.

5. Wireless Client Settings

- SSID of Remote AP: click 'Survey', select the SSID of the Access Point, and click 'Connect'.
- Security: select 'WPA-PSK/WPA2-PSK'.
- PSK Password: enter the password of the Access Point.
- Distance Setting: enter the distance between the client and the remote Access Point to be connected. It is recommended to round the number up to the nearest integer.

6. Wireless AP Settings: Click 'Next'.

7. Finish: Click 'Finish'.



After finishing the CPE configuration for the subscribers, please change the IP settings of your computer to 'Obtain an IP address automatically' and 'Obtain DNS server address automatically'.

• Hotspot

Hotspot application is used to provide Internet access for wireless devices such as smartphones, tablets and laptops.

If the CPE is connected to a router, we recommend setting it in the Access Point mode.

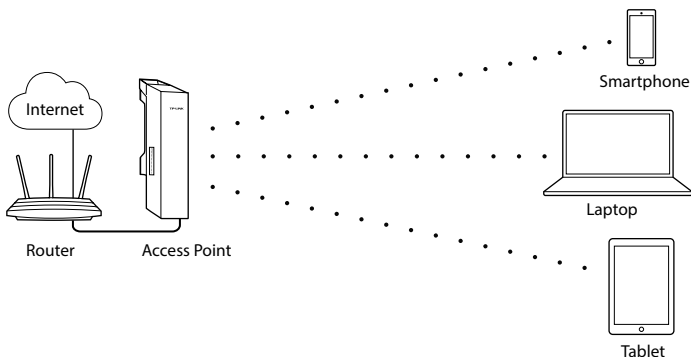

Refer to the following steps to configure the CPE.

Configure the Access Point

- 1. Log in to PharOS**
- 2. Go to the Quick Setup page**
- 3. Operation Mode**
 - Select 'Access Point'.
 - Click 'Next'.
- 4. LAN Settings:** Click 'Next'.
- 5. WAN AP Settings**
 - SSID: customize the name for the network as you like.
 - Security: select 'WPA-PSK/WPA2-PSK'.
 - PSK Password: create the password for the network as you like.
 - Click 'Next'.
- 6. Finish:** Click 'Finish'.

If the CPE is connected to a Modem, we recommend setting it in the AP Router mode.

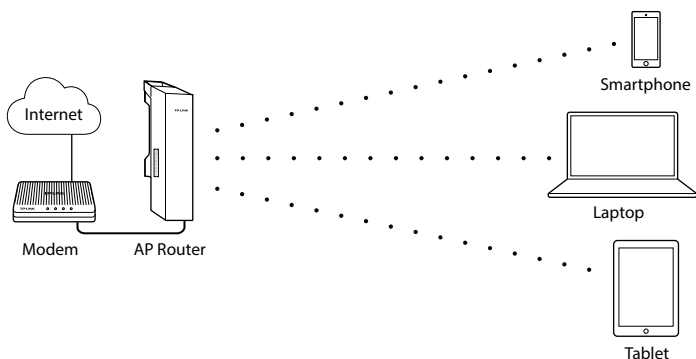

Refer to the following steps to configure the CPE.

Configure the AP Router (equal to a SOHO router)

1. Log in to PharOS
2. Go to the Quick Setup page
3. Operation Mode
 - Select 'AP Router'.
 - Click 'Next'.
4. WAN Connection Type
 - *These settings may vary depending on the ISP. Please contact your ISP for the correct information.
 - Select 'Dynamic IP'.
 - Click 'Next'.
5. Wireless AP Settings
 - SSID: enter the name for the network as you like.
 - Security: select 'WPA-PSK/WPA2-PSK'.
 - PSK Password: enter the password for the network as you like.
 - Click 'Next'.
6. Finish: Click 'Finish'.

Antenna Alignment

In order to get the best performance, you can precisely align the direction of the CPE with the assistance of 'Wireless Signal Quality' on 'STATUS' page of the PharOS Web Interface.

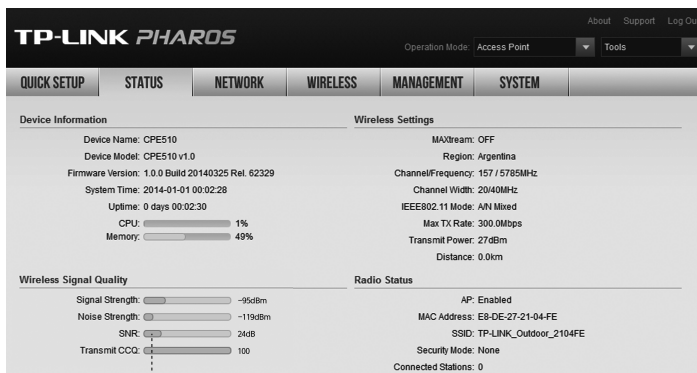

Adjust the direction of the CPE until the device reaches the highest SNR.

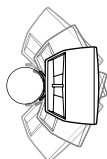

WISP

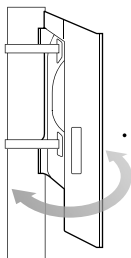

WISP

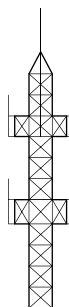

Specifications

HARDWARE FEATURES				
Dimensions	CPE520/CPE220: 275.83*79*60.3mm CPE510/CPE210: 224.34*79*60.3mm			
Interface	LAN0: 10/100Mbps Ethernet Port(PoE IN) LAN1: 10/100Mbps Ethernet Port GND: Grounding Terminal for Lightning Protection RESET: Button to restore the device to Factory Default			
Power Supply	24V Passive PoE Adapter Included			
ESD Protection ¹	15kV			
Lightning Protection ¹	Up to 6kV			
Operating Temperature	-30°C ~ 70°C (-22°F ~ 158°F)			
Operating Humidity	10% ~ 90%			
Certification	CE, FCC, RoHS, IPX5			
WIRELESS FEATURES				
Models	CPE210	CPE220	CPE510	CPE520
Antenna Gain	9dBi	12dBi	13dBi	16dBi
Horizontal Beamwidth/ Elevation Beamwidth ²	70°/ 45°	45°/ 30°	45°/ 30°	50°/ 20°
Maximum Transmit Power ³	27dBm	30dBm	27dBm	30dBm
Operating Frequency ³	2.4- 2.4835GHz	2.4- 2.4835GHz	5.15- 5.85GHz	5.15- 5.85GHz
802.11 Standards	11b/g/n	11b/g/n	11a/n	11a/n

Note:

1. Estimation is based on copper grounding cable and shielded CAT5e cable with ground wire.
2. Beamwidth values may vary throughout operating frequency.
3. Maximum transmit power and operating frequency may vary in different countries or regions.

FAQ (Frequently Asked Questions)

Q1. How to restore the CPE to its factory default settings?

With the CPE powered on, press and hold the 'RESET' button of the CPE or the 'Remote Reset' button of the passive PoE adapter for about 8 seconds until the Wireless Signal Strength LEDs flash.

Method 1:

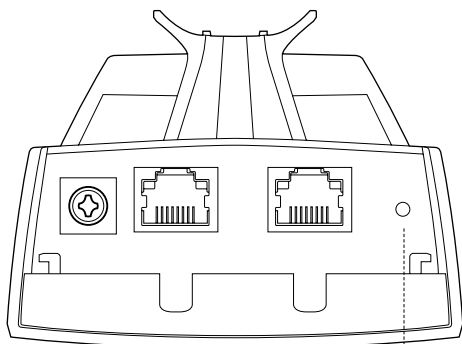

RESET Button

Press & hold for about 8 seconds

Method 2:

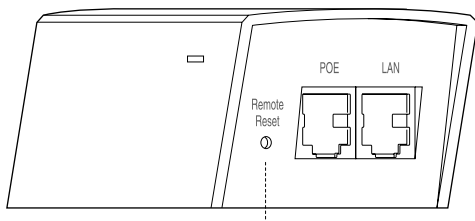

Remote Reset Button

Press & hold for about 8 seconds

Q2. How to calculate the minimum mounting height of the devices?

In order to maximize the received signal strength of the devices, installers need to minimize the effect of the out-of-phase signals, which is caused by obstacles in the path between the transmitter and the receiver. Fresnel Zone is a usual method to calculate this path, as shown in the formula and the figure below.

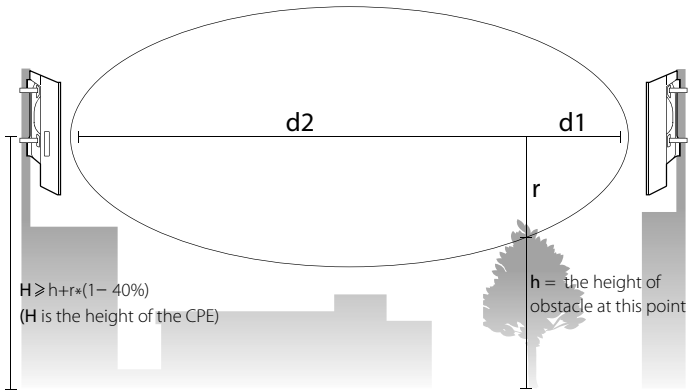

$$r = \sqrt{\frac{d_1 \times d_2}{d_1 + d_2} \cdot \frac{c}{f}}$$

where,

r = Fresnel zone radius in meters

$c = 3 \times 10^8$ m/s, speed of light

f = operating frequency of the devices in Hz

d_1 & d_2 = the distances between the point and the devices in meters

For example, assume d_1 is 2km, d_2 is 8km, and f is 2.4GHz, then r would be 14.142m. Considering a toleration of 40%, allowable radius would be 8.485m. Assume h is 10m, then the result of the minimum mounting height based on this point would be 18.485m. Similarly, calculate the results based on all the points where there are obstacles, and the maximum value would be the final result.

For more information, please refer to:

http://en.wikipedia.org/wiki/Fresnel_zone

Q3. How can I use Spectrum Analysis to find the appropriate channel for the devices?

1. Log in to PharOS, on the 'WIRELESS' page, you can find the 'Spectrum Analysis' button as shown in the figure below. Click the button.

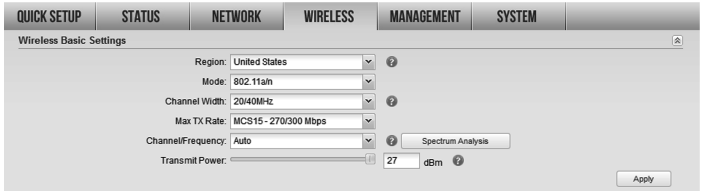

2. The following window will pop up. Click 'Yes' and you will then get into the 'Spectrum Analysis' page.

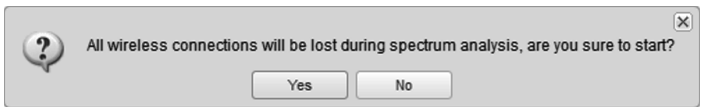

3. Select the 'Frequency Range' and click the 'Start' button, the PharOS will begin to analyze the power of the frequency. Watch the curves for a period of time, and then click 'Stop'. Mark the relatively low and continuous part of the 'average' curve, and note the corresponding frequency range. Here we take the figure below as an example.

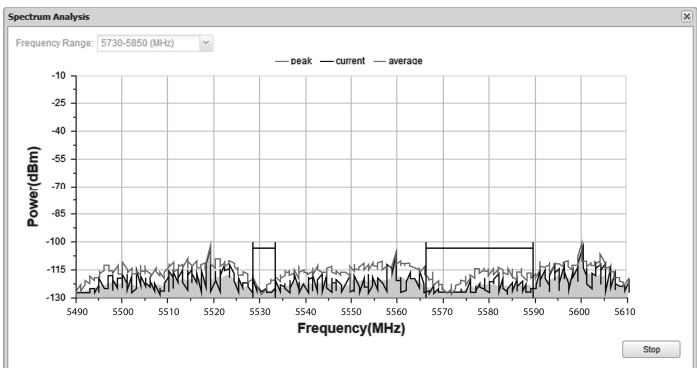

- Close the Spectrum Analysis Window, and then you will get back to the 'WIRELESS' page. For the Channel/Frequency option, it is recommended to select a value whose frequency is within the noted frequency range.

So, in this example, the recommended Channel/Frequency is 116/5580MHz.

Q4. What is Pharos MAXstream?

Pharos MAXstream is a proprietary protocol developed on the basis of Time Division Multiple Access (TDMA) by TP-LINK.

The MAXstream technology has the following advantages:

- Eliminates hidden node collisions & improves channel efficiency.
- Lower latency, higher throughput, larger network capacity & more stability.

To enable the MAXstream function among the AP and stations, you only need to select the MAXstream option on the 'WIRELESS' page of the PharOS Web Interface of the AP, shown as the figure below. Then the stations will automatically adjust their connections to the AP.

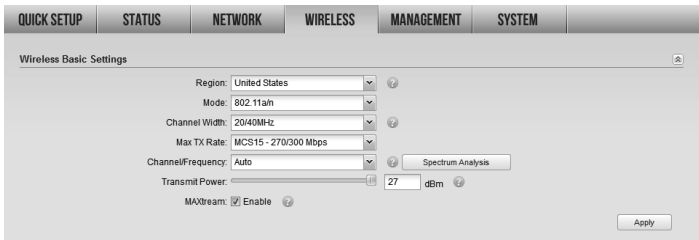

Pharos MAXstream is a non-standard Wi-Fi protocol that is only compatible with TP-LINK's Pharos series products. Please notice that you will not be able to connect other Wi-Fi devices to an AP with MAXstream enabled.

FCC STATEMENT



This equipment has been tested and found to comply with the limits for a Class A digital device, pursuant to part 15 of the FCC Rules. These limits are designed to provide reasonable protection against harmful interference when the equipment is operated in a commercial environment. This equipment generates, uses, and can radiate radio frequency energy and, if not installed and used in accordance with the instruction manual, may cause harmful interference to radio communications. Operation of this equipment in a residential area is likely to cause harmful interference in which case the user will be required to correct the interference at his own expense.

This device complies with part 15 of the FCC Rules. Operation is subject to the following two conditions:

1. This device may not cause harmful interference.
2. This device must accept any interference received, including interference that may cause undesired operation.

Any changes or modifications not expressly approved by the party responsible for compliance could void the user's authority to operate the equipment.

CE Mark Warning



This is a class A product. In a domestic environment, this product may cause radio interference, in which case the user may be required to take adequate measures.

IC STATEMENT

This Class A digital apparatus complies with Canadian ICES-003.

Cet appareil numérique de la classe A est conforme à la norme NMB-003 du Canada.



Продукт сертифіковано згідно с правилами системи УкрСЕПРО на відповідність вимогам нормативних документів та вимогам, що передбачені чинними законодавчими актами України.



Safety Information

- When product has power button, the power button is one of the way to shut off the product; When there is no power button, the only way to completely shut off power is to disconnect the product or the power adapter from the power source.
- Don't disassemble the product, or make repairs yourself. You run the risk of electric shock and voiding the limited warranty. If you need service, please contact us.
- Avoid water and wet locations.

NCC Notice & BSMI Notice

注意！

依據 低功率電波輻射性電機管理辦法

第十二條 經型式認證合格之低功率射頻電機，非經許可，公司、商號或使用者均不得擅自變更頻率、加大功率或變更原設計之特性或功能。

第十四條 低功率射頻電機之使用不得影響飛航安全及干擾合法通信；經發現有干擾現象時，應立即停用，並改善至無干擾時方得繼續使用。前項合法通信，指依電信規定作業之無線電信。低功率射頻電機需忍受合法通信或工業、科學以及醫療用電波輻射性電機設備之干擾。

減少電磁波影響，請妥適使用。



於 5.25GHz 至 5.35GHz 區域內操作之無線設備的警告聲明
工作頻率 5.250~5.350GHz 該頻段限於室內使用。

安全諮詢及注意事項

請使用原裝電源供應器或只能按照本產品注明的電源類型使用本產品。

- 清潔本產品之前請先拔掉電源線。請勿使用液體、噴霧清潔劑或濕布進行清潔。
- 注意防潮，請勿將水或其他液體潑灑到本產品上。
- 插槽與開口供通風使用，以確保本產品的操作可靠並防止過熱，請勿堵塞或覆蓋開口。
- 請勿將本產品置放於靠近熱源的地方。除非有正常的通風，否則不可放在密閉位置中。
- 請不要私自打開機殼，不要嘗試自行維修本產品，請由授權的專業人士進行此項工作。

此為甲類資訊技術設備，于居住環境中使用時，可能會造成射頻擾動，在此種情況下，使用者會被要求採取某些適當的對策。

This product can be used in the following countries:

AT / BG / BY / CA / CZ / DE / DK / EE / ES / FI / FR / GB / GR / HU / IE / IT
LT / LV / MT / NL / NO / PL / PT / RO / RU / SE / SK / TR / UA / US

COPYRIGHT & TRADEMARKS

Specifications are subject to change without notice.

TP-LINK is a registered trademark of TP-LINK TECHNOLOGIES CO., LTD. Other brands and product names are trademarks or registered trademarks of their respective holders. No part of the specifications may be reproduced in any form or by any means or used to make any derivative such as translation, transformation, or adaptation without permission from TP-LINK TECHNOLOGIES CO., LTD. Copyright © 2014 TP-LINK TECHNOLOGIES CO., LTD. All rights reserved.

Website: <http://www.tp-link.com>

Tel: +86 755 26504400

E-mail: support@tp-link.com