



	kg	1,52	1,52	2,4	2,56
	mm	360	375	474	594
		1/4"	3/8" 1/2"	1/2"	1/2"
		9 x 12	9 x 12	14 x 18	14 x 18
	kg-cm mini. max.	15,3 → 306,1	69 → 1378	102 → 2041	173 → 3469
	in.lb min. max.	13,3 → 265,5	60 → 1195	88 → 1770	150 → 3009
	ft.lb min. max.	1,11 → 22,12	5 → 99,5	7,4 → 147,5	12,5 → 250,7
	N.m min. max.	1,5 → 30	6,8 → 135	10 → 200	17 → 340
		E.316-30D	E.316-135D	E.316-200D	E.316-340D

EN

Dear Customers,

Thank you for purchasing our digital torque wrench. This manual will help you to use the many features of your new digital torque wrench. **Before operating the torque wrench, please read this manual completely, and keep it nearby for future reference**

MAIN FEATURES

- Head Interchangeable
- Digital torque value readout
- +/-2 % accuracy
- +/-2 ° accuracy for 90° angle rotation
- CW and CCW operation
- Peak hold and track mode selectable
- Buzzer and LED indicator for the 9 pre-settable target torques
- Engineering units (N.m, ft-lb, in-lb, kg-cm, "°") selectable
- 50 or 250 data memory for recall and joint torque auditing
- Auto Sleep after about 2 minutes idle
- Both AA and rechargeable batteries are compatible

NAMES AND FUNCTIONS OF PARTS (A)

1. LCD Display
2. Buzzer
3. Communication Port
4. Buttons
5. Battery Compartment
6. Battery Cover
7. LED Indicator
8. Torque / Angle value
9. Max. Value Index
10. Units(N.m, ft-lb, in.lb, kg.cm)
11. P(Peak hold mode) /T(Track mode)
12. Clear Button
13. Max. Value Select
14. Unit/Setting Button
15. Up/Down Button

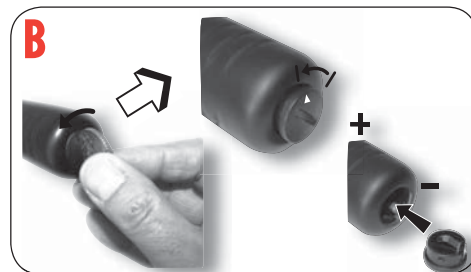
**SPECIFICATIONS**

	E.316-30D - E.316-135D E.316-200D - E.316-340D
Torque Accuracy *1	±2%
Angle Accuracy *2	+/-2 ° for 90° angle rotation
Data memory size	250
PC Connectivity *3	Yes / USB
Pre-setting No.	9 sets
Bright LED	12 LED / 2 Red+10 Green
Operation Mode	Peak Hold / Track
Unit Selection	N.m, ft.lb, in.lb, kg.cm
Head Type	Round Head Ratchet Insert
Button	2
Battery	AA x 2
Battery Life *4 (Continuous operation)	60 hrs.
Battery Life *4 (Standby)	1 Year
Operating Temperature	-10°C → 60°C
Storage Temperature	-20°C → 70°C
Humidity	Up to 90% non-condensing
Drop Test	1 m
Vibration Test *5	10 G
Life time *6	10000 cycle
Environmental test *7	Pass
Electromagnetic compatibility test *8	Pass

Note:

- *1: The accuracy of the readout is guaranteed from 20% to 100% of maximum range + / - 1 increment. The torque accuracy is a typical value. Calibration line is at the middle line of the dark spot on the rubber handle. For keeping the accuracy, calibrate the wrench for a constant period time (1 year). And the accuracy is based on the zero degree of offset from perpendicular drive.
- *2: The angle accuracy is guaranteed at +/- 2° when rotating wrench to 90° at the speed of 30°/sec.
- *3: Use a special designed USB cable (accessory) to upload record data to PC.
- *4: Use two AA batteries (Test condition: Toshiba carbon-zinc R6UG battery)
- *5: Horizontal and vertical test
- *6: One cycle means swing the torque wrench from 0 N.m to maximum range and back to 0 N.m.
- *7: Environmental test:
- a. Dry heat
 - b. Cold
 - c. Damp heat
 - d. Change of temperature
 - e. Impact (shock)
 - f. Vibration
 - g. Drop

- *8: Electromagnetic compatibility test:
- a. Electrostatic discharge immunity (ESD)
 - b. Radiated susceptibility
 - c. Radiated emission

COMMUNICATION**Precaution:**

1. Communication function is only supported on some models. Check the model no. and its specification before using communication function.
2. Do not insert the plug of communication cable into torque wrench that does not support communication function.

CONNECTING COMMUNICATION CABLE

- Connect the accessory cable between the USB COM port of PC and torque wrench.

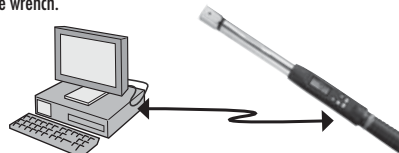
**UPLOADING RECORD DATA**

- Make sure the connection between PC and wrench is normal.
- Press **C** **A** together to reset the wrench.
- Change the wrench operation mode to "Send". (Refer to "Peak Hold Mode Recorded Value Review" section)
- Use PC to start the uploader program.
- In uploader program, first select the correct COM port No.
- Next, select the file path to save the uploaded data.
- Finally, press "upload" button to transmit the torque records to PC.
- The uploaded data is then shown on the column and saved in the *.csv file. Use Microsoft Excel to view *.csv file.

CAUTIONS:

- Refer to the uploader program user guide for the detail operations.

MAINTENANCE AND STORAGE**ATTENTION:**

One-year periodic recalibration is necessary to maintain accuracy. Please contact your local dealer for calibrations.

CAUTION:

1. Over-torque (110% of Max. torque range) could cause breakage or lose accuracy.
2. Do not shake violently or drop wrench.
3. Do not use this wrench as a hammer.
4. Do not leave this wrench in any place exposed to excessive heat, humidity, or direct sunlight.
5. Do not use this apparatus in water.(not waterproof)
6. If the wrench gets wet, wipe it with a dry towel as soon as possible. The salt in seawater can be especially damaging.
7. Do not use organic solvents, such as alcohol or paint thinner when cleaning the wrench.
8. Keep this wrench away from magnets.
9. Do not expose this wrench to dust or sand as this could cause serious damage.
10. Do not apply excessive force to the LCD panel.
11. Apply torque slowly and grasp the center of the handle. Do not apply load to the end of handle

BATTERY MAINTENANCE

1. When the wrench is not used for an extended period of time, remove the battery.
2. Keep a spare battery on hand when going on a long trip or to cold areas.
3. Do not mix battery types or combine used batteries with new ones.
4. Sweat, oil and water can prevent a battery's terminal from making electrical contact. To avoid this, wipe both terminals before loading a battery.
5. Dispose of batteries in a designated disposal area. Do not throw batteries into a fire.

BELGIQUE FACOM Belgique B.V.B.A.
Egide Walschaertstraat 14-16
2800 MECHELEN
LUXEMBOURG BELIGUE
☎ : +32 (0) 15 47 39 35
Fax : +32 (0) 15 47 39 71

NETHERLANDS FACOM Gereedschappen BV
Martinus Nijhofflaan 2
2624 ES DEFT
P.O. BOX 1007 · 2600 BA Delft
NETHERLANDS
☎ : 0800 236 236 2
Fax : 0800 237 60 20

DANMARK FACOM NORDEN
Nordre Strandvej 1198
FINLAND 3150 HELLEBÄK
ISLAND DENMARK
NORGE ☎ : +45 49 76 27 77
SVERIGE Fax : +45 49 76 27 66

SINGAPORE FACOM TOOLS FAR EAST
Far East
N° 25 Senoko South Road
Woodlands East Industrial Estate
Singapore 758081
SINGAPORE
☎ : [65] 6752 2001
Fax : [65] 6752 2697

DEUTSCHLAND FACOM
Stanley Deutschland GmbH
Otto-Hahn-Straße 9
42369 Wuppertal
DEUTSCHLAND
☎ : +49 202 69 819329
Fax : +49 202 69 819350

SUISSE FACOM WERKZEUGE GMBH
Kingsstrasse 14
8600 DUBENDORF
ÖSTERREICH SUISSE
☎ : 41 44 802 8093
MAGYARORSZAG Fax : 41 44 802 8091
ČESKA REP.

ESPAÑA FACOM Herramientas S.L.
Poligono industrial de Vallecas
C/Luis 1°, s/n-Naves 95 - 2ºPl.
28031 Madrid
PORTUGAL ESPAÑA
☎ : +34 91 778 21 13
Fax : + 34 91 380 65 33

UNITED KINGDOM FACOM-UK
Europa view
SHEFFIELD BUSINESS PARK
Europa link
SHEFFIELD S9 1 XH
ENGLAND
☎ : [44] 114 244 8883
Fax : [44] 114 273 9038

ITALIA SWK Utensilerie S.r.l.
Via Volta 3
21020 Momalio (VA)
ITALIA
☎ : [0332] 790 381
Fax : [0332] 790 307

POLSKA FACOM Tools Polska Sp. zo.o.
ul.Medlicka 190
03-119 Warszawa
POLSKA
☎ : [48 22] 510 3627
Fax : [48 22] 5103656

FRANCE & INTERNATIONAL

FACOM S.A.S.
6-8, rue Gustave Eiffel B.P.99
F-91423 Morançais cedex
FRANCE
☎ : 01 64 54 45 45
Fax : 01 69 09 60 93
<http://www.facom.com>

En France, pour tous renseignements techniques sur l'outillage à main,
téléphonez au : 01 64 54 45 14

FACOM

Pro for life



Instruction manual

E.316-30D
845011

E.316-135D
845020

E.316-200D
845038

E.316-340D
845046

NUen-E.316/0410

BEFORE USING THE WRENCH

- BATTERY INSTALLATION**
- Remove the battery cover.
 - Insert two AA batteries matching the +/- polarities of the battery to the battery compartment.
 - Put on the battery cap and rotate it tightly according to the following figures.

- POWER ON AND RESETTING THE WRENCH**
- Press **C** to power on the digital torque wrench.
 - Usually press **C** to reset the digital torque wrench before using it.

ATTENTION:
If an external force is applied to the torque wrench during power-on/reset or wake up period, an initial torque offset will exist in the memory.

- ACTIVATION DURING SLEEP MODE**
- The wrench will auto sleep after about 2 minutes idle for power saving. Press **C** to wake up the wrench during the sleep mode.

CAUTIONS:
During communication period (**Send** appears), the sleep function is disabled.

- RESETTING THE WRENCH**
- To reset the wrench, loosen the battery cap then tighten it to re-start.
 - After reset, remember to press **C**.

- LOW BATTERY VOLTAGE PROTECTION**
- If the battery serial voltage is under 2.3 volts, the wrench will display a battery symbol and then turn off after a while.

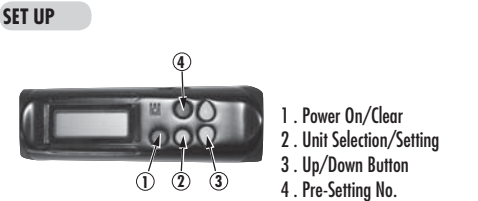

STEP 1: PRE-SETTING NO.

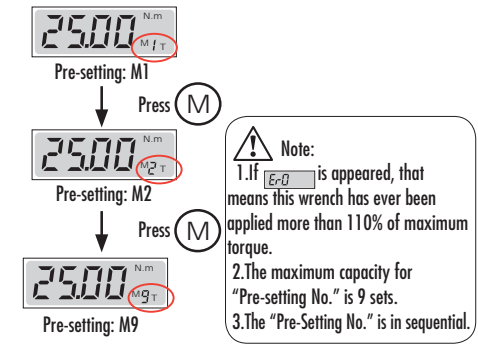

STEP 2: UNIT SELECTION

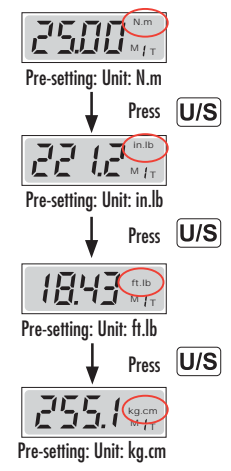

STEP 4: PEAK HOLD / TRACK MODE SELECTION

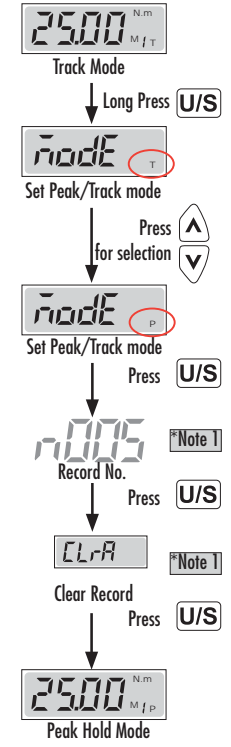

Note:
1. Please skip this procedure and continue to the next spet.

STEP 3: SET TORQUE VALUE

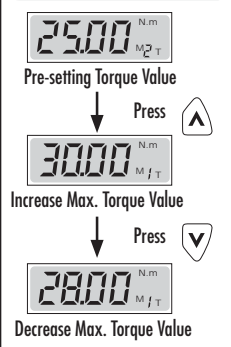

Note:
1. The "Unit Selection" is in sequential.

TRACK MODE OPERATION

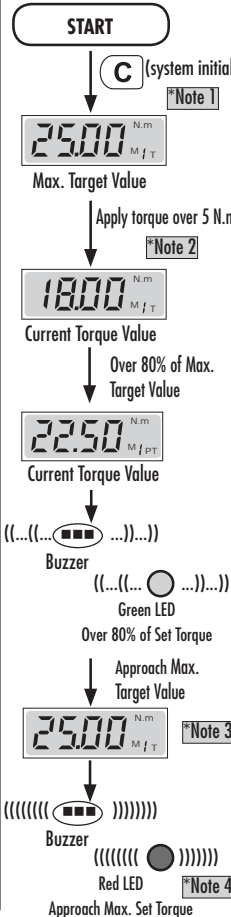

Note:
1. If **ErD** is appeared, that means this wrench has ever been applied over than 110% of maximum torque.
2. When using track mode, if you apply torque over 5 N.m, the LCD display will start to display the torque value. If the applied is less than 5 N.m, the LCD display does not have any value changes. The smallest torque for E.316-30D series is 0.5 N.m.
3. The green LED will be on for 80%, 85%, 90%, 95% and 97.5% of maximum setting torque.
4. The red LED will be on 99.5% of maximum setting torque.

PEAK HOLD MODE OPERATION

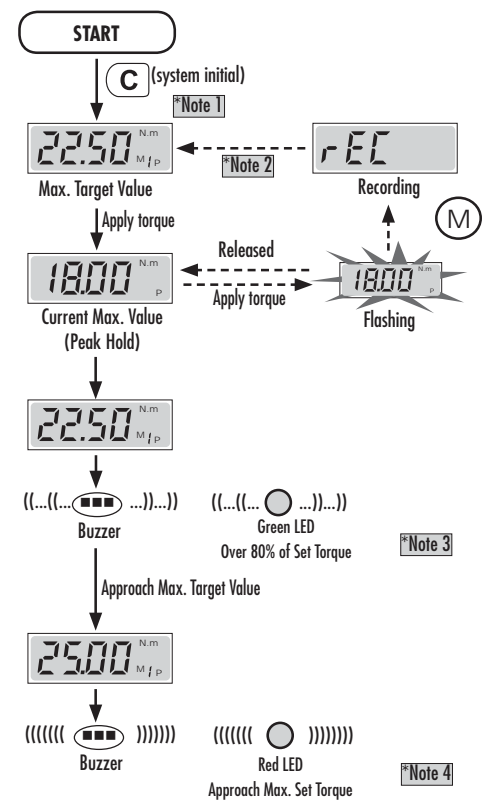

Note:
1. If **ErD** is appeared, that means this wrench has ever been applied over than 110% of maximum torque.
2. If **Full** is appeared, that means the wrench's memory is full and the next value record can not be written in. Please refer the "Peak Hold Mode Recorded Value Review" section to clear the memory data.
3. The green LED will be on for 80%, 85%, 90%, 95% and 97.5% of maximum setting torque.
4. The red LED will be on 99.5% of maximum setting torque.

PEAK HOLD MODE RECORDED VALUE REVIEW

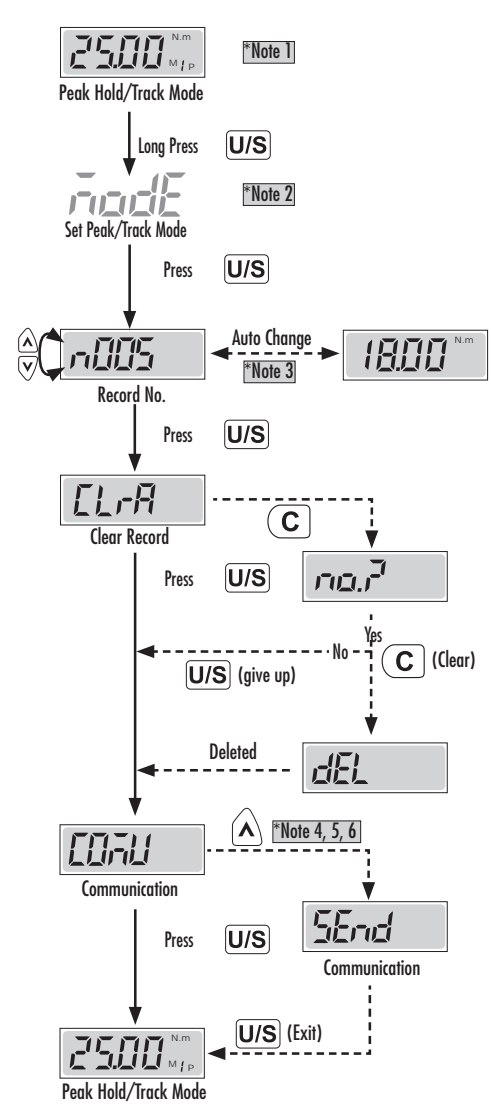

Note:
1. The "Peak Hold" mode recorded value review also can be operated in "Track" mode operation.
2. If you operate in the "Peak Hold" mode, the display will show **node** and please go to next step.
3. If the record is empty, it will show **node**.
4. This function is not supported on all type of models.
5. Communication mode is for uploading record data to PC.
6. Communication mode is also for calibration of torque wrench. Please contact your local dealer for more information.

KEY LOCK

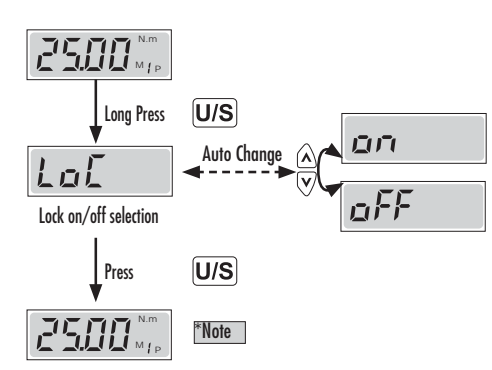

Note:
If "LoC on" is set, the display will show **----** while pressing **▲, ▼, U/S**

ANGLE MODE OPERATION

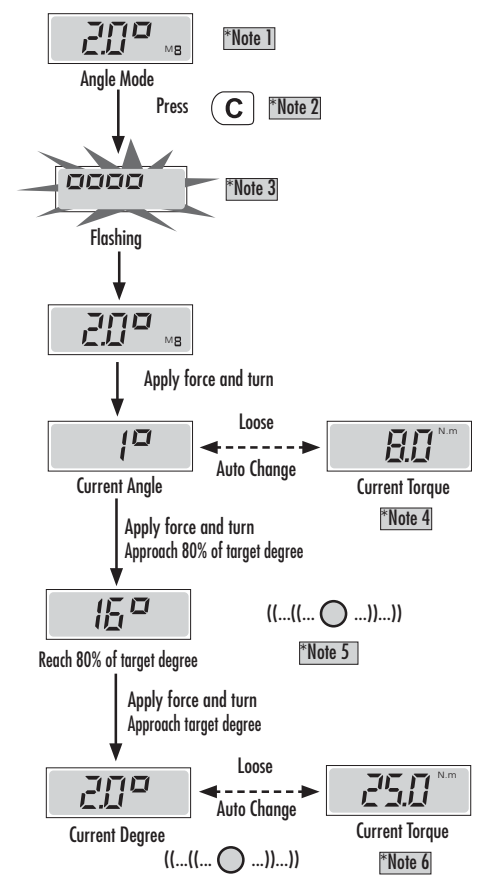

Note 2:
1. When entering angle mode, the unit will be Degree.
2. When angle is in auto initial mode, please keep the wrench steady without any disturbance.
3. After a while, the angle function will be in initiative mode with the flashing **0000**.
4. When loosing the wrench with angle mode, the display will show the corresponding torque value with flashing state.
5. The Green LED will be on with 80%, 85%, 90%, 95% and 97.5% of target degree.
6. When reaching the target degree, the green and red LED will be on at the same time.

TORQUE UNIT SELECTION UNDER ANGLE MODE

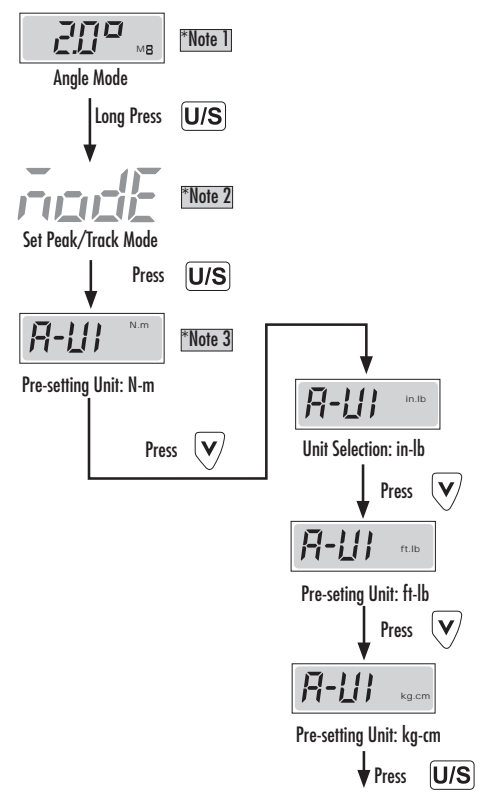

Note:
1. The unit setting could be also entered from the torque mode.
2. Please skip the procedure and go to next step.
3. The unit selection is cyclic