

Thank you for purchasing this digital torque-angle adaptor. This manual will help you to use the many features of your new digital torque-angle adaptor. Before operating the torque adaptor, please read this manual completely, and keep it nearby for future reference.

MAIN FEATURES

- Digital torque-angle value readout
- +/- 2° (rotating 90° at speed of 30°/sec) for angle accuracy
- +/- 3% or +/- 4% for torque accuracy
- CW and CCW operation
- Buzzer and LED indicator for the 9 pre-settable target torques or angles
- Five Units Selectable (N.m, ft-lb, in-lb, kg.cm, degree)
- 50 data memory for recall and joint torque-angle auditing
- Auto Sleep after about 2 minutes idle
- Both AAA and rechargeable batteries are compatible

NAMES AND FUNCTIONS OF PARTS

- | | |
|-----------------------|-----------------------|
| 1. LED Indicator | 7. Memory Number |
| 2. Buzzer | 8. Buttons |
| 3. LCD Display | 9. Communication Port |
| 4. Torque/Angle Value | 10. Extension bar |
| 5. Units | 11. Battery cover |
| 6. Peak/Track Mode | |

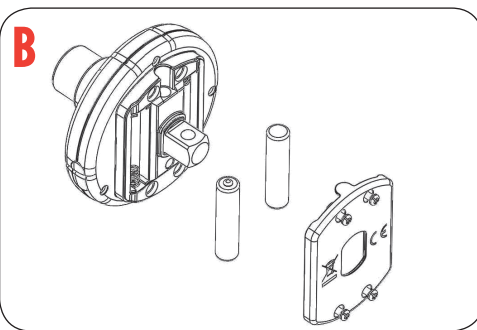
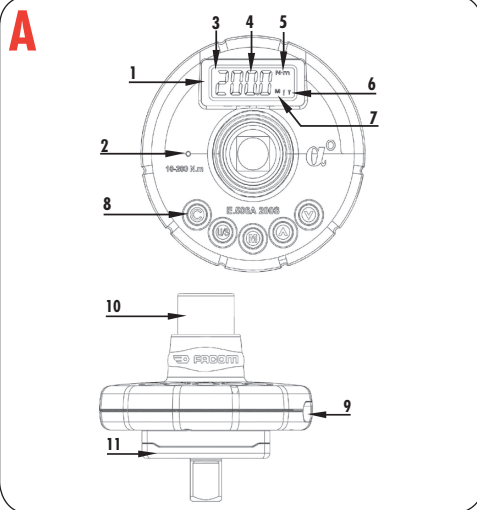

SPECIFICATIONS	E.506-135S - E.506-200S - E.506-340S
Torque Accuracy *1	CW / CCW :±3% / ±4%
Angle Accuracy *2	+/- 2° (rotating 90° at speed of 30°/sec)
Measured Angle Range	1° → 999.0°
Data memory size	50
PC Connectivity *3	No
Pre-setting No	9 sets
Bright LED	12 LED / 2 Red+10 Green
Torque Operation Mode	Peak Hold / Track
Unit selection	N.m, ft-lb, in-lb, kg.cm, degree
Button	5
Battery	AAA x 2
Battery Life *4 (Continuous operation)	24 hrs.
Battery Life *4 (Standby)	1 Year
Operating Temperature	-10°C → 60°C
Storage Temperature	-20°C → 70°C
Humidity	Up to 90% non-condensing
Drop Test	1 m
Vibration Test *5	10 G
Life time *6	10000 cycle
Environmental test *7	Pass
Electromagnetic compatibility test *8	Pass

Note: *1: The accuracy of the readout is guaranteed from 20% to 100% of maximum range +/- 1 increment. For maintaining accuracy, calibrate the adaptor at regular intervals (1 year recommended).

*2: The angle accuracy is guaranteed at ±2° when rotating adaptor to 90° at speed of 30°/sec.

*3: Use a special designed cable (accessory) to upload record data to PC.

*4: Use two AAA batteries (Tested condition: Toshiba carbon-zinc battery)

*5: Horizontal and vertical test.

*6: One cycle means turning the torque adaptor from 0 N.m to maximum torque and back to 0 N.m.

*7: Environmental test: a. Dry heat e. Impact (shock)
b. Cold f. Vibration
c. Damp heat g. Drop
d. Change of temperature

*8: Electromagnetic compatibility test:
a. Electrostatic discharge immunity (ESD) b. Radiated susceptibility
c. Radiated emission

BEFORE USING THE ADAPTOR

BATTERY INSTALLATION

- Loosen the screw of the battery cover.
- Insert two AAA batteries matching the +/- polarities of the battery to the battery compartment.
- Put on the battery cap and rotate it tightly according to the following figures.

POWER ON AND AUTO ZERO RESET

- Let the adaptor be sat without touching it
- Gently press  to power on.

- Auto zero-reset will be processed first.
- The adaptor will be started in torque or angle mode. Which mode will be started depends on in which mode the adaptor is powered-off last time.
- In torque mode, first is torque zero-reset and then a target torque screen will show.
- In angle mode, it first do several seconds of angle- zero-reset and then a target angle screen will show. (Very important issue: See attention)
- If it takes too long in angle reset, press  will perform reset again.

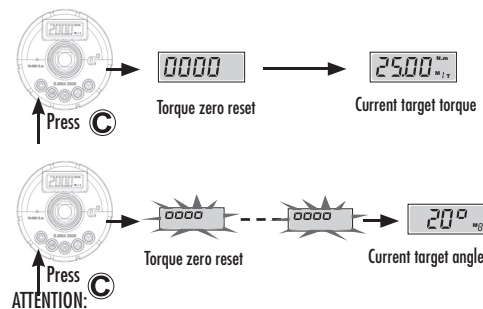

1. If  is appeared, refer to "ERROR MESSAGE".

2. IMPORTANT!

During angle reset, keep the adaptor still and never shake, vibrate or even touching the adaptor.

If the adaptor is moving again and again, the zero reset will not stop.

Finally,  will be shown. (Refer to "ERROR MESSAGE")

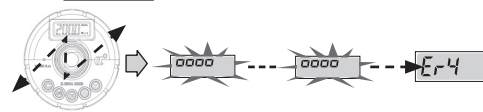

AUTO POWER OFF

The adaptor will auto power off after about 2 minutes idle for power saving.

CAUTIONS:

During communication period ( appears), the auto power-off function is disabled.

- Press  for zero reset.

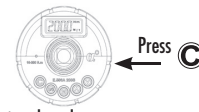

- Usually press  to zero reset the digital torque-angle adaptor before using the adaptor. It will guarantee a better accuracy.

- In angle mode, please keep the adaptor steady without any disturbance and press  to do zero-reset.

- In torque mode, if an external force is applied to the torque adaptor during zero-reset period, an initial torque offset error will occur.

HARDWARE RESET

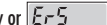
- To do hardware reset, remove battery and re-install it.
- If the adaptor does not function normally or  appears, please go through the reset process to reset the adaptor.



ERROR MESSAGE

-  **LOW VOLTAGE INDICATOR**



If the battery voltage is too low, the adaptor will display a battery symbol and then turn off. Replace batteries.

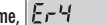

When  shows during power-on process, it means this adaptor has ever been applied more than 110% of torque of the spec. The accuracy of torque may be lost.





In angle mode, if the adaptor does not reset successfully for a period of time,  will be shown. Press  to do zero-reset again. Notice that during resetting process, never vibrate or shake the adaptor. Keep it rest.

 shows that the adaptor does not work functionally, please do hardware reset. Refer to "HARDWARE RESET".

In angle mode, iff the adaptor rotates too fast,  will be shown. Do press  to zero reset the adaptor.

OPERATION



FAST GETTED START

- Press  to power on. No applying forces on adaptor.
- Target torque or angle will be shown.
- Press  to select the torque unit or "°" (angle mode) and then press  to set target value.
- Or press  to select the pre-set target values.
- Press  to reset adaptor. (suggested).
- Start to rotate adaptor.
- Watch out the warning LED, sounds and LCD to stop rotation.



T-mode torque operation

- In T-mode, LCD displays the current torque value.
- After release force, the LCD value will return to 0.

P-mode torque operation

- In P-mode, LCD displays the maximum torque value.
- After release force, the LCD shows the caught maximum value. (flashing)
- Now press  to record maximum torque value, or press  to clear it.

Angle operation

- In angle mode, LCD displays the angle rotated after the reaching over 5% of the rated maximum torque.
- Now press  to record angle value, or press  to clear it.

1- INSTALL THE ADAPTOR AND POWER ON

- Press  to power on the adaptor.

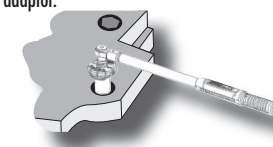



2- NO APPLING FORCES ON ADAPTOR

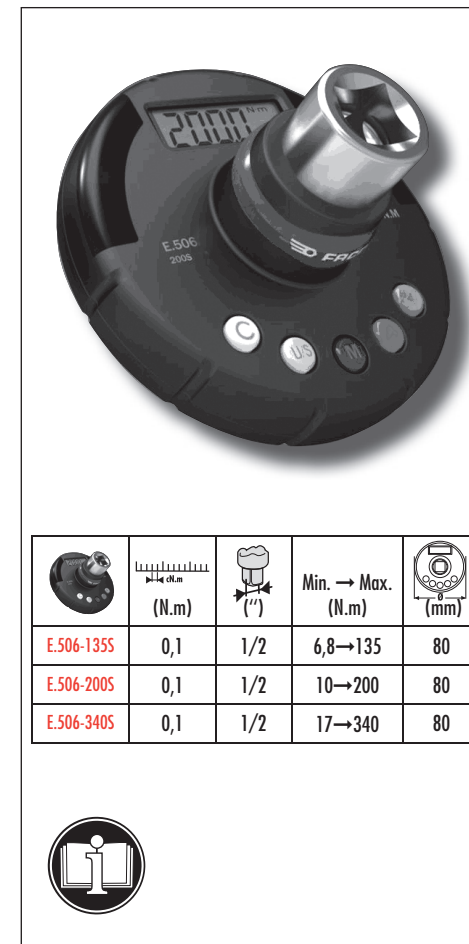

Pro for life



	 (N.m)	 (°)	Min. → Max. (N.m)	 (mm)
E.506-135S	0,1	1/2	6,8→135	80
E.506-200S	0,1	1/2	10→200	80
E.506-340S	0,1	1/2	17→340	80



3- TARGET TORQUE OR ANGLE WILL BE SHOWN

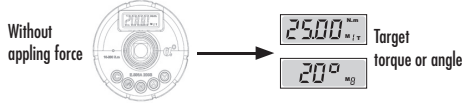

4- SET TARGET TORQUE OR ANGLE

- Press (US) to select the torque unit (torque mode) or "°" (angle mode).
- Then press (A) or (V) to set target value.
- Note that the target value will be saved automatically with the current M number discarding torque or angle.
- Another way is to press (M) to select the pre-set target value (M1 ~ M9)

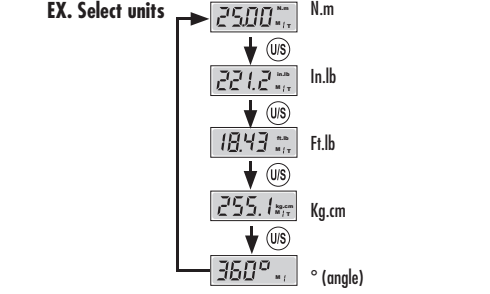

● if [-----] is shown as press (US) (A) or (V). It indicates that the key is locked.

Please refer to "Key Lock/Unlock" to un-lock keypad.

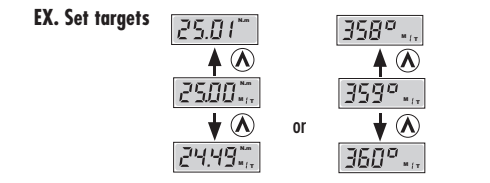

5- ZERO-RESET ADAPTOR

- Press (C) to zero-reset the adaptor. (suggested)
- Refer to "POWER ON AND AUTO ZERO RESET" and "ZERO RESET".

TORQUE ONLY

6- CHECK P/T MODE OF TORQUE

- Refer to "P/T MODE SELECTION" to set P or T-mode operation of torque.

Definition

T-mode torque view

1. In T-mode, if a force is applied on adaptor, LCD displays and tracks the current torque value.
2. After releasing force, the LCD value will return to target setting view.

P-mode torque view

1. In P-mode, LCD displays the maximum torque value.
2. After releasing force, the LCD shows the caught maximum value. (flashing)

7- START TO ROTATE ADAPTOR

- Rotate the adaptor clockwise or counter-clockwise
-

8- WATCH OUT THE WARNING LED, SOUNDS AND LCD TO STOP ROTATION

- There are 12 LEDs to indicate the current torque or angle reaching 80%, 85%, 90%, 95%, 97.5% and 99.5% of target torque/angle.

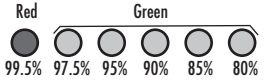

- There is also a buzzer to indicate the reaching level of target value. Interval sound means it reaches over 80% and long sound means it reaches over 99.5% of target value.

(((((.....)))...)) → over 80 %
 (((((((.....))))))...)) → over 99.5 %

9- TORQUE / ANGLE VALUE WHEN ROTATES

T-mode Torque value

- In T-mode, if a force is applied on adaptor, LCD displays and tracks the current torque value.
 - After releasing force, the LCD value will return to target setting view.
-

P-mode Torque value

- In P-mode, LCD displays the maximum torque value.
 - After releasing force, the LCD shows the maximum value. (flashing)
-

Angle value

- In angle mode, LCD displays the angle rotated. The angle is counted after the rotation torque has been reaching over 5% of the rated maximum torque.
- After releasing force, the LCD shows the maximum angle and the maximum torque. (alternatively)

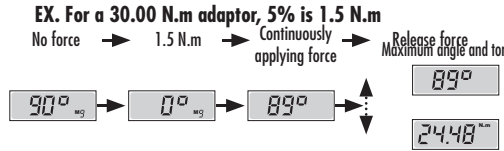

10- SAVE TORQUE / ANGLE VALUE OR CLEAR MAXIMUM VALUE

P-mode

- In P-mode, after releasing force, the LCD shows the maximum value. (flashing).
- Pressing (C) will clear the maximum torque and go back to show the target torque.
- Pressing (M) will record the maximum torque, then clear it and go back to show the target torque.

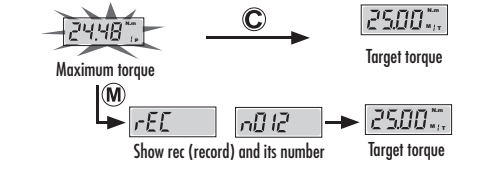

Angle-mode

- In angle-mode, after releasing force, the LCD shows the maximum angle and the maximum torque (alternatively).
- Pressing (C) will clear the maximum angle and go back to show the target angle.
- Pressing (M) will record the maximum angle, then clear it and go back to show the target angle.

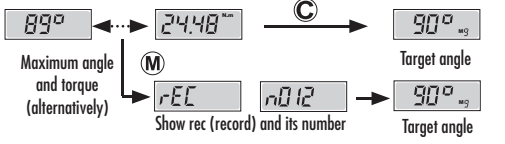

11- BACK TO STEP 2 FOR NEXT OPERATION

VISIT SETUP MENU

- From the target torque/angle screen, long press (US) to go into setup menu. Continuously press (US) can visit the P/T mode menu, torque-unit-in-angle-operation menu, key lock menu, record menu, record clear-all menu, operation count menu and communication menu. Finally press (US) again to skip out the setup menu and go back to the target torque/angle screen.

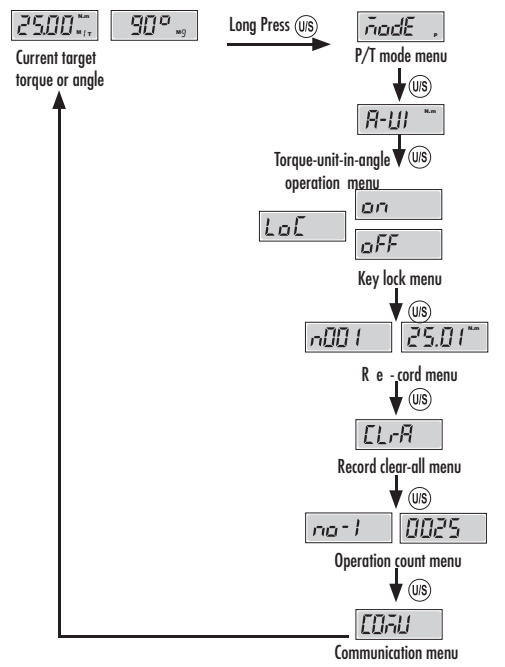

P/T MODE SELECTION

- Visit the P/T mode menu, press (A) or (V) to select the Peak-hold or Track mode of torque operation.
- Continuously pressing (US) will skip out the setup menu and go back to the target torque/angle screen.

SELECT TORQUE UNIT IN ANGLE OPERATION

- Visit the torque-unit-in-angle-operation menu, press (A) or (V) to select the torque unit during angle rotation.
- Continuously pressing (US) will skip out the setup menu and go back to the target torque/angle screen.

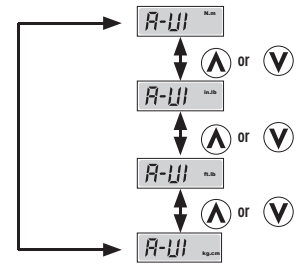

KEY LOCK/UN-LOCK

- Visit the key lock menu, press (A) or (V) to select the key lock on or off.
- Continuously pressing (US) will skip out the setup menu and go back to the target torque/angle screen.

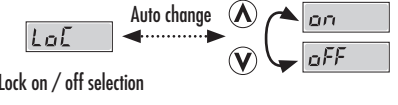

VIEW DATA RECORD

- Visit the record menu, press (A) or (V) to select the data number and view it.
- If no record exists, nonE will be shown.
- Continuously pressing (US) will skip out the setup menu and go back to the target torque/angle screen.



CLEAR A SINGLE RECORD

- Visit the record menu
- Press (A) or (V) to select the data number you want to delete.
- Press (C) twice to delete the current data. (dEL will be shown)
- If press (C) once, no.2 will be shown. If you want to abandon, just press (US) to skip out this menu.
- Continuously pressing (US) will skip out the setup menu and go back to the target torque/angle screen.

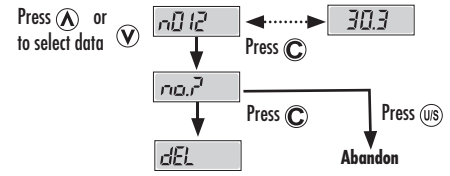

CLEAR ALL RECORDS

- Visit the record clean-all menu
- Press (C) twice to delete the all record data. (dEL will be shown)
- If press (C) once, no.2 will be shown. If you want to abandon, just press (US) to skip out this menu.
- Continuously pressing (US) will skip out the setup menu and go back to the current target angle screen.

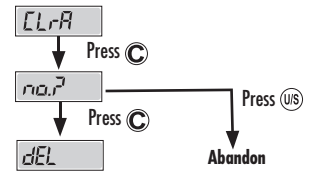

VIEW OPERATION COUNTS

- Visit the operation counts, the operation counts will be shown.
- Operation counting record counts every time the adaptor has been used over 60% of maximum torque. This record is not erasable until re-calibration.
- The feature will count up to 65,000 measurements.
- The following figure means the recorded count is 10025.
- Continuously pressing (US) will skip out the setup menu and go back to the target torque/angle screen.

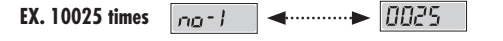

MAINTENANCE AND STORAGE

ATTENTION:
 One-year periodic recalibration is necessary to maintain accuracy. Please contact your local dealer for calibrations.

- 1- **CAUTION:** Over-torquing (110% of Max. torque range) could cause breakage or lose of accuracy.
- 2- Do not shake violently or drop adaptor.

- 3- Do not leave this adaptor in any place exposed to excessive heat, humidity, or direct sunlight.
- 4- Do not use this apparatus in water. (it is not waterproof)
- 5- If the adaptor gets wet, wipe it with a dry towel as soon as possible. The salt in seawater can be especially damaging.
- 6- Do not use organic solvents, such as alcohol or paint thinner when cleaning the adaptor.
- 7- Keep this adaptor away from magnets.
- 8- Do not expose this adaptor to dust or sand as this could cause serious damage.
- 9- Do not apply excessive force to the LCD panel.

BATTERY MAINTENANCE

- 1- When the adaptor is not going to be used for an extended period of time, remove the batteries.
- 2- Keep a spare battery on hand when going on a long trip or to cold areas.
- 3- Do not mix battery types or combine used batteries with new ones.
- 4- Sweat, oil and water can prevent a battery's terminal from making electrical contact. To avoid this, wipe both terminals before loading a battery.
- 5- Dispose of batteries in a designated disposal area. Do not throw batteries into a fire.