

Universal stands



OZB-A5201



OZB-A5202



OZB-A5203

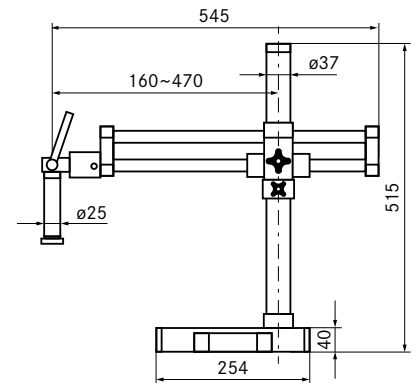
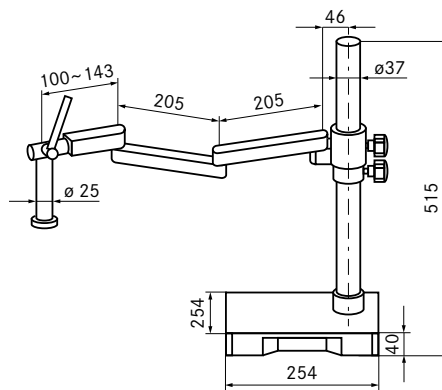
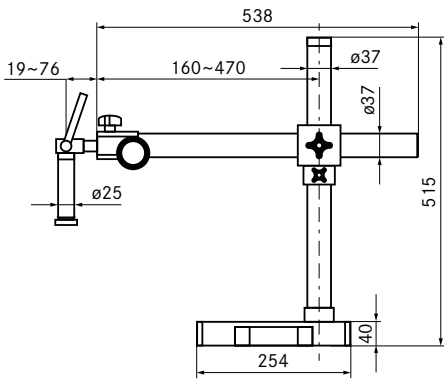

Model	Description	
KERN		
OZB-A5201	Universal stand with telescopic arm	
OZB-A5202	Universal stand with jointed arm	
OZB-A5203	Universal stand with ball bearing mounted double arm	

Holders































OZB-A5301



OZB-A5306

Model	Description	
KERN		
OZB-A5301	With adjustable tension of the hand wheel. Suitable for all universal stands as well as the illustrated accessory-pillar stands and for models of series OSF 5x, OZM, OZO and OZP	
OZB-A5306	With coaxial coarse and fine adjustment and adjustable tension of the hand wheel. Suitable for all universal stands as well as the illustrated accessory-pillar stands and for models of series OSF 5x, OZM, OZO and OZP	

 360°	360° rotatable microscope head	 FL-HB0	Fluorescence illumination for compound microscopes With 100 W mercury lamp and filter	 AUTO ATC	Automatic temperature compensation For measurements between 10 °C and 30 °C
 MONO	Monocular Microscope For the inspection with one eye	 FL-LED	Fluorescence illumination for compound microscopes With 3 W LED illumination and filter	 IP	Protection against dust and water splashes IPxx The type of protection is shown by the pictogram.
 BINO	Binocular Microscope For the inspection with both eyes	 PH	Phase contrast unit For a higher contrast	 BATT	Battery operation Ready for battery operation. The battery type is specified for each device.
 TRINO	Trinocular Microscope For the inspection with both eyes and the additional option for the connection of a camera	 POLAR	Polarising unit To polarise the light	 ACCU	Rechargeable battery pack Rechargeable set.
 ABBE	Abbe Condenser With high numerical aperture for the concentration and the focusing of light	 INFINITY	Infinity system Infinity corrected optical system	 230 V	Mains adapter 230V/50Hz in standard version for EU. On request GB, AUS or USA version.
 HAL	Halogen illumination For pictures bright and rich in contrast	 ZOOM	Zoom magnification For stereomicroscopes	 230 V	Power supply Integrated in balance. 230V/50Hz standard EU. More standards e.g. GB, AUS or USA on request.
 LED	LED illumination Cold, energy saving and especially long-life illumination	 PARALLEL	Parallel optical system For stereomicroscopes, enables fatigue-proof working	 DAYS	Package shipment The time required to manufacture the product internally is shown in days in the pictogram.
 IL	Incident illumination For non-transparent objects	 SCALE	Integrated scale In the eyepiece	 3 YEARS WARRANTY	Warranty The warranty period is shown in the pictogram.
 TL	Transmitting illumination For transparent objects	 USB 2.0	Integrated USB 2.0 digital camera For direct transmitting of the picture to a PC		
 FL	Fluorescence illumination For stereomicroscopes	 USB 3.0	Integrated USB 3.0 digital camera For direct transmitting of the picture to a PC		

Abbreviations

C-Mount	Adapter for the connection of a camera to a trinocular microscope	N.A.	Numerical Aperture	W.D.	Working Distance
H(S)WF	High (Super) Wide Field (Eyepiece with high eye point for wearers of glasses)	SLR Kamera	Single-Lens Reflex camera	WF	Wide Field (Field number up to Ø 22 mm for 10x eyepiece)
LWD	Long Working Distance	SWF	Super Wide Field (Field number at least Ø 23 mm for 10x eyepiece)		

Your KERN specialist dealer: