

Multi-Range DC Power Supply

PSW Series

PROGRAMMING MANUAL

VERSION: 1.5



ISO-9001 CERTIFIED MANUFACTURER

GW INSTEK

This manual contains proprietary information, which is protected by copyright. All rights are reserved. No part of this manual may be photocopied, reproduced or translated to another language without prior written consent of Good Will company.

The information in this manual was correct at the time of printing. However, Good Will continues to improve products and reserves the rights to change specification, equipment, and maintenance procedures at any time without notice.

Good Will Instrument Co., Ltd.
No. 7-1, Jhongsing Rd., Tucheng Dist., New Taipei City 236, Taiwan.

Table of Contents

SAFETY INSTRUCTIONS	4
GETTING STARTED	8
PSW Series Overview	9
Appearance	14
Configuration Settings	21
REMOTE CONTROL	29
Interface Configuration	30
Socket Server Examples	45
Command Syntax	49
Command List	52
Status Register Overview	95
Error List	106
APPENDIX	115
PSW Default Settings	115
Error Messages & Messages	118
LED Display Format	118
INDEX	119

S SAFETY INSTRUCTIONS

This chapter contains important safety instructions that you must follow during operation and storage. Read the following before any operation to insure your safety and to keep the instrument in the best possible condition.

Safety Symbols

These safety symbols may appear in this manual or on the instrument.



Warning: Identifies conditions or practices that could result in injury or loss of life.



Caution: Identifies conditions or practices that could result in damage to the PSW or to other properties.



DANGER High Voltage



Attention Refer to the Manual



Protective Conductor Terminal



Earth (ground) Terminal



Do not dispose electronic equipment as unsorted municipal waste. Please use a separate collection facility or contact the supplier from which this instrument was purchased.

Safety Guidelines

General Guideline



CAUTION

- Do not place any heavy object on the PSW.
- Avoid severe impact or rough handling that leads to damaging the PSW.
- Do not discharge static electricity to the PSW.
- Use only mating connectors, not bare wires, for the terminals.
- Do not block the cooling fan opening.
- Do not disassemble the PSW unless you are qualified.

(Measurement categories) EN61010-1:2010 and EN61010-2-030 specify the measurement categories and their requirements as follows. The PSW falls under category II.

- Measurement category IV is for measurement performed at the source of low-voltage installation.
- Measurement category III is for measurement performed in the building installation.
- Measurement category II is for measurement performed on the circuits directly connected to the low voltage installation.
- 0 is for measurements performed on circuits not directly connected to Mains.

Power Supply



WARNING

- AC Input voltage range: 85VAC~265VAC
 - Frequency: 47Hz~63Hz
 - To avoid electrical shock connect the protective grounding conductor of the AC power cord to an earth ground.
-

-
- Cleaning the PSW
- Disconnect the power cord before cleaning.
 - Use a soft cloth dampened in a solution of mild detergent and water. Do not spray any liquid.
 - Do not use chemicals containing harsh material such as benzene, toluene, xylene, and acetone.
-

Operation Environment

- Location: Indoor, no direct sunlight, dust free, almost non-conductive pollution (Note below)
- Relative Humidity: 20%~ 85%
- Altitude: < 2000m
- Temperature: 0°C to 50°C

(Pollution Degree) EN61010-1:2010 and EN61010-2-030 specify the pollution degrees and their requirements as follows. The PSW falls under degree 2.

Pollution refers to “addition of foreign matter, solid, liquid, or gaseous (ionized gases), that may produce a reduction of dielectric strength or surface resistivity”.

- Pollution degree 1: No pollution or only dry, non-conductive pollution occurs. The pollution has no influence.
 - Pollution degree 2: Normally only non-conductive pollution occurs. Occasionally, however, a temporary conductivity caused by condensation must be expected.
 - Pollution degree 3: Conductive pollution occurs, or dry, non-conductive pollution occurs which becomes conductive due to condensation which is expected. In such conditions, equipment is normally protected against exposure to direct sunlight, precipitation, and full wind pressure, but neither temperature nor humidity is controlled.
-

Storage environment

- Location: Indoor
 - Temperature: -25°C to 70°C
 - Relative Humidity: <90%
-

Disposal



Do not dispose this instrument as unsorted municipal waste. Please use a separate collection facility or contact the supplier from which this instrument was purchased. Please make sure discarded electrical waste is properly recycled to reduce environmental impact.

Power cord for the United Kingdom

When using the power supply in the United Kingdom, make sure the power cord meets the following safety instructions.

NOTE: This lead/appliance must only be wired by competent persons



WARNING: THIS APPLIANCE MUST BE EARTHED

IMPORTANT: The wires in this lead are coloured in accordance with the following code:

Green/ Yellow:	Earth
Blue:	Neutral
Brown:	Live (Phase)



As the colours of the wires in main leads may not correspond with the coloured marking identified in your plug/appliance, proceed as follows:

The wire which is coloured Green & Yellow must be connected to the Earth terminal marked with either the letter E, the earth symbol  or coloured Green/Green & Yellow.

The wire which is coloured Blue must be connected to the terminal which is marked with the letter N or coloured Blue or Black.

The wire which is coloured Brown must be connected to the terminal marked with the letter L or P or coloured Brown or Red.

If in doubt, consult the instructions provided with the equipment or contact the supplier.

This cable/appliance should be protected by a suitably rated and approved HBC mains fuse: refer to the rating information on the equipment and/or user instructions for details. As a guide, a cable of 0.75mm² should be protected by a 3A or 5A fuse. Larger conductors would normally require 13A types, depending on the connection method used.

Any exposed wiring from a cable, plug or connection that is engaged in a live socket is extremely hazardous. If a cable or plug is deemed hazardous, turn off the mains power and remove the cable, any fuses and fuse assemblies. All hazardous wiring must be immediately destroyed and replaced in accordance to the above standard.

G ETTING STARTED

This chapter describes the power supply in a nutshell, including its main features and front / rear panel introduction, as well as an overview of the configuration settings.



PSW Series Overview	9
Series lineup.....	9
Main Features.....	10
Accessories.....	11
Appearance	14
PSW Front Panel.....	14
Rear Panel.....	17
Configuration Settings	21

PSW Series Overview

Series lineup

The PSW series consists of 15 models, divided into 3 different model types covering 3 power capacities: Type I (360 Watt), Type II (720 Watt) and Type III (1080 Watt).



Note

Throughout the user manual, PSW 30, PSW 80, PSW 160, PSW 250 or PSW 800 will refer to any of the PSW models with a maximum voltage rating of 30V, 80V, 160V, 250V or 800V, respectively.

Model name	Type	Voltage Rating	Current Rating	Power
PSW 30-36	Type I	0~30V	0~36A	360W
PSW 80-13.5	Type I	0~80V	0~13.5A	360W
PSW 160-7.2	Type I	0~160V	0~7.2A	360W
PSW 250-4.5	Type I	0~250V	0~4.5A	360W
PSW 800-1.44	Type I	0~800V	0~1.44A	360W
PSW 30-72	Type II	0~30V	0~72A	720W
PSW 80-27	Type II	0~80V	0~27A	720W
PSW 160-14.4	Type II	0~160V	0~14.4A	720W
PSW 250-9	Type II	0~250V	0~9A	720W
PSW 800-2.88	Type II	0~800V	0~2.88A	720W
PSW 30-108	Type III	0~30V	0~108A	1080W
PSW 80-40.5	Type III	0~80V	0~40.5A	1080W
PSW 160-21.6	Type III	0~160V	0~21.6A	1080W
PSW 250-13.5	Type III	0~250V	0~13.5A	1080W
PSW 800-4.32	Type III	0~800V	0~4.32A	1080W

Apart from the differences in output, each unit differs in size. The 720 and 1080 watt models are larger than the 360 watt models to accommodate the increase in power.

360 Watt models

Type I

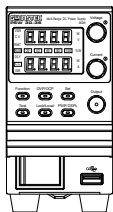

720 Watt models

Type II

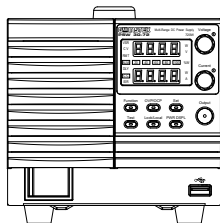

1080 Watt models

Type III

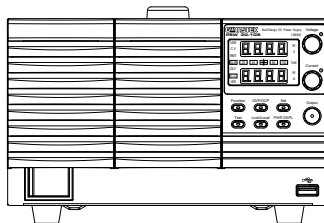

Main Features

Performance

- High performance/power
 - Power efficient switching type power supply
 - Low impact on load devices
 - Fast transient recovery time of 1ms
 - Fast output response time
-

Features

- OVP, OCP and OTP protection
 - Adjustable voltage and current slew rates
 - User adjustable bleeder control to quickly dissipate the power after shutdown to safe levels.
 - Extensive remote monitoring and control options
 - Support for serial* and parallel connections.
*(30, 80, 160 volt models only)
 - Power on configuration settings.
 - Supports test scripts
 - Web server monitoring and control
-

- Interface
- Ethernet port
 - Analog connector for analog voltage and current monitoring
 - USB host and device port

Accessories

Please check the contents before using the PSW.

PSW 30/80/160 Accessories

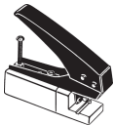
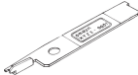

Standard Accessories	Part number	Description
	CD-ROM	User manual, programming manual
	4323-30600101	Power cord (Type I/II)
	4320-91001101	Power cord (Type III)
	1042-SWLV0301	Output terminal cover
	GTL-123	Test leads: 1x red, 1x black
	GTL-240	USB Cable
	PSW-004	Basic Accessory Kit: M4 terminal screws and washers x2, M8 terminal bolts, nuts and washers x2, Air filter x1, Analog control protection dummy x1, Analog control lock level x1
Optional Accessories	Part number	Description
	GET-001	Extended terminal
	PSW-001	Accessory Kit: Pin contact x10, Socket x1, Protection cover x1

PSW-002	Simple IDC Tool	
PSW-003	Contact Removal Tool	
PSW-005	Series operation cable for 2 units.	
PSW-006	Parallel operation cable for 2 units.	
PSW-007	Parallel operation cable for 3 units.	
GRA-410-J	Rack mount adapter (JIS)	
GRA-410-E	Rack mount adapter (EIA)	
GUG-001	GPIB to USB adapter	
GTL-240	USB Cable	
57RG-30B00201	Large filter (Type II/III)	

Download	Name	Description
	psw_cdc.inf	USB driver

PSW 250/800 Accessories

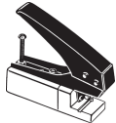
Standard Accessories	Part number	Description
	CD-ROM	User manual, programming manual
	4323-30600101	Power cord (Type I/II)
	4320-91001101	Power cord (Type III)
	1042-SWHV0301	High voltage output terminal cover
	GTL-240	USB Cable
	39BT-50900401	High voltage output terminal

	PSW-008	Basic Accessory Kit: (Air filter x1, Analog control protection dummy x1, Analog control lock level x1)
Optional Accessories	Part number	Description
	GET-002	Extended terminal
	PSW-001	Accessory Kit: Pin contact x10, Socket x1, Protection cover x1
	PSW-002	Simple IDC Tool 
	PSW-003	Contact Removal Tool 
	PSW-006	Parallel operation cable for 2 units.
	PSW-007	Parallel operation cable for 3 units.
	GRA-410-J	Rack mount adapter (JIS)
	GRA-410-E	Rack mount adapter (EIA)
	GTL-130	Test leads: 2x red, 2x black
	GUG-001	GPIB to USB adapter
	GTL-240	USB Cable
	57RG-30B00201	Large filter (Type II/III)
Download	Name	Description
	psw_cdc.inf	USB driver

Appearance

PSW Front Panel

720W: PSW 30-72, 80-27, 160-14.4, 250-9, 800-2.88

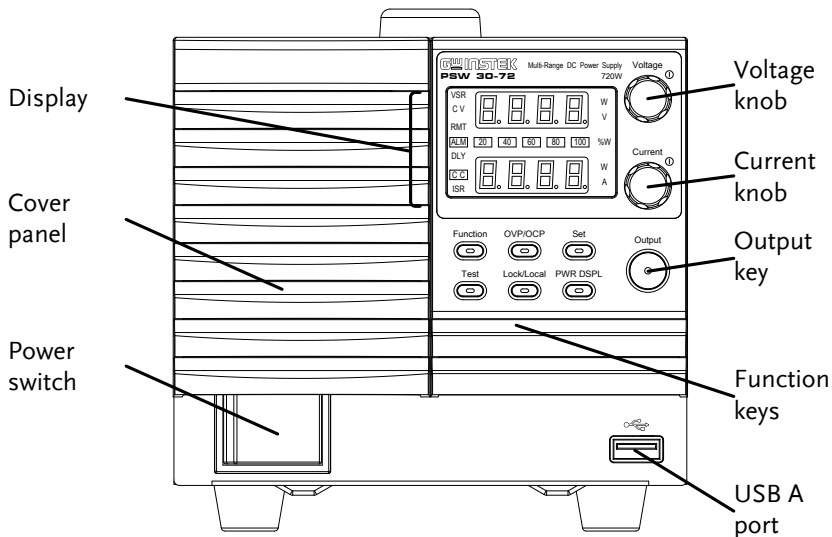

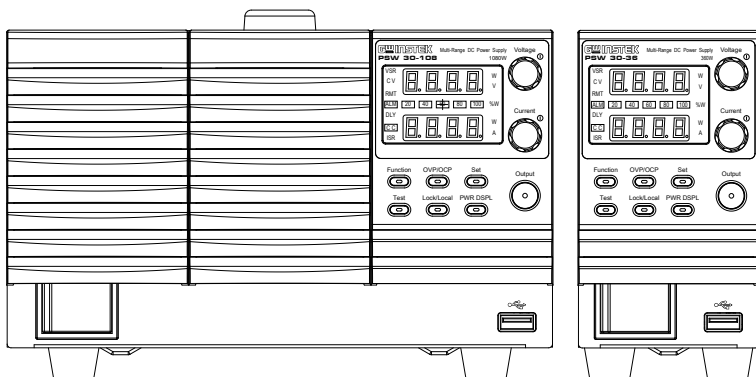

1080W: PSW 30-108, 80-40.5, 160-21.6, 250-13.5, 800-4.32

360W: PSW 30-36, 80-13.5, 160-7.2, 250-4.5, 800-1.44





Function Keys The Function keys along with the Output key will light up when a key is active.

Function  The Function key is used to configure the power supply.

OVP/OCP  Set the over current or over voltage protection levels.

Set  Sets the current and voltage limits.

Test  Used to run customized scripts for testing.

Lock/Local  Locks or unlocks the panel keys to prevent accidentally changing panel settings.

PWR DSPL  Toggles the display from viewing V/A → V/W → A/W.

Display Indicators	VSR	Voltage Slew Rate
	C V	Constant Voltage Mode
	RMT	Remote Control Mode
	ALM	Alarm on
	DLY	Delay Output
	CC	Constant Current Mode
	ISR	Current Slew Rate

20 **40** **60**
80 **100** % W

Power bar

Indicates the current power output as a percentage.

Voltage Knob

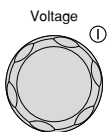

Sets the voltage.

Current Knob

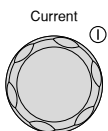

Sets the current.

Output

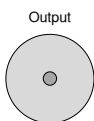

Press to turn on the output. The Output key will light up when the output is active.

USB

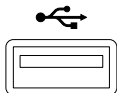

USB A port for data transfer, loading test scripts etc.

Power Switch

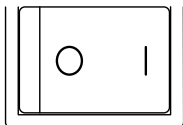

Used to turn the power on/off.

Rear Panel

720W: PSW 30-72, 80-27, 160-14.4

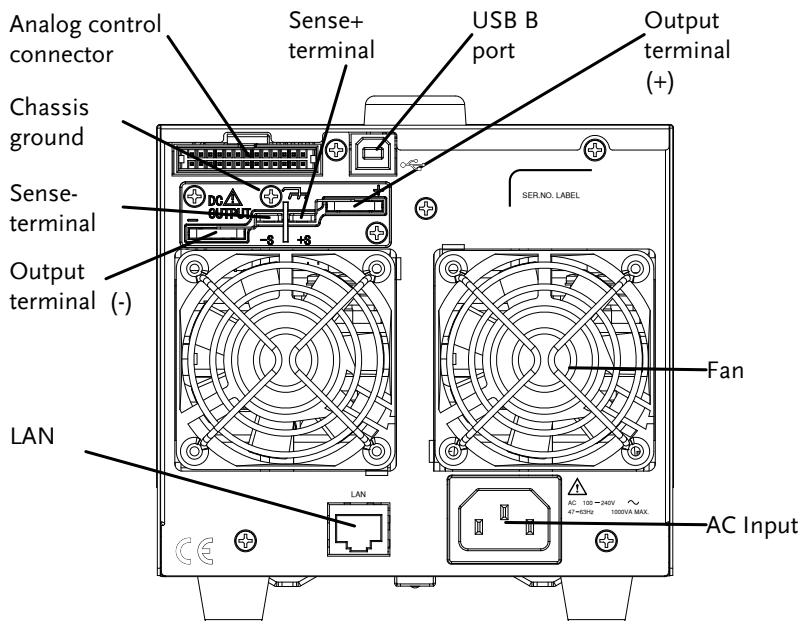

1080W: PSW 30-108, 80-40.5, 160-21.6

360W: PSW 30-36,
80-13.5, 160-7.2

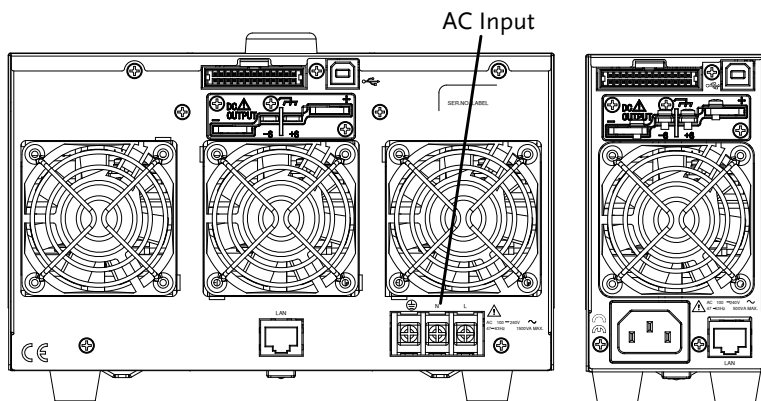

720W: PSW 250-9, 800-2.88

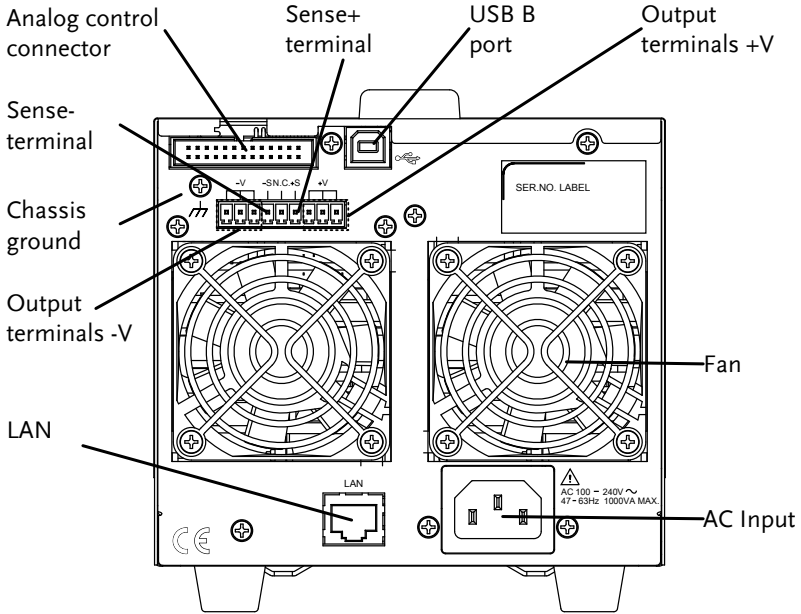

1080W: PSW 250-13.5, 800-4.32

360W: PSW 250-4.5, 800-1.44

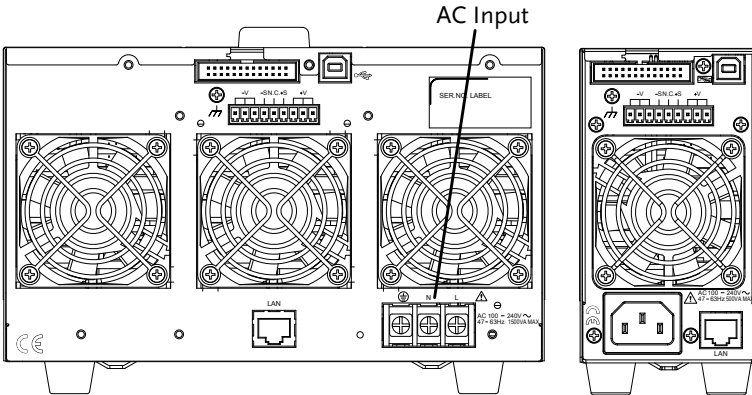

Analog Control Connector



Standard 26 pin MIL connector (OMRON XG4 IDC plug).

The analog control connector is used to monitor current and voltage output, machine status (OVP, OCP, OTP etc.), and for analog control of the current and voltage output.

Use an OMRON XG5 IDC socket as the mating socket.

Output Terminals (30, 80, 160 volt models)

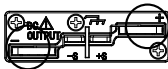

Positive (+) and negative (-) output terminals.



Chassis ground

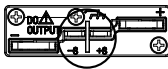

Sense (-S) and Sense (+S) terminals.

Output Terminals (250, 800 volt models)

The 250 and 800 volt models use a 9 pin connector and a plug for the output and sense terminal connections. The plug is a MC420-38109Z plug by DECA SwitchLab Inc. This plug is also available separately (GW part number 39BT-50900401).

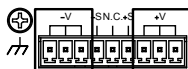

Positive (V+) and negative (V-) output terminals (3 of each).

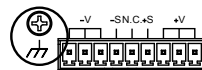

Chassis ground



Sense (-S) and Sense (+S) terminals.

USB B port

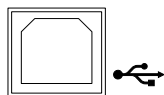

The USB B port is used for remote control.

Fans

Temperature controlled fans

Ethernet Port

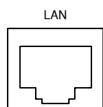

The ethernet port is used for remote control and digital monitoring from a PC.

Line Voltage Input
(Type I/TypeII)

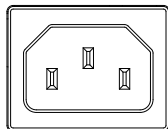

Type I: PSW 30-36/80-13.5/
160-7.2/250-4.5, 800-1.44

Type II: PSW 30-72/80-27/
160-14.4/250-9, 800-2.88

- Voltage Input: 100~240 VAC
- Line frequency: 50Hz/60 Hz
(Automatically switchable)

Line Voltage Input
(Type III)

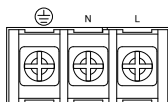

Type III:
PSW 30-108/80-40.5/160-21.6/
250-13.5/800-4.32

- Voltage Input: 100~240 VAC
- Line frequency: 50Hz/60 Hz
(Automatically switchable)

Configuration Settings

Configuration of the PSW power supplies is divided into five different configuration settings: Normal Function, USB/GPIB, LAN, Power ON Configuration, Calibration Settings and System Settings. Power ON Configuration differs from the other settings in that the settings used with Power ON Configuration settings can only be set during power up. The other configuration settings can be changed when the unit is already on. This prevents some important configuration parameters from being changed inadvertently. Power On Configuration settings are numbered F-90 to F-95 and the other configuration settings are numbered F-00 to F-61 and F-88 to F-89.

Setting Normal Function Settings

The normal function settings (F-01~F-61, F-88~F-89) can be easily configured with the Function key.

- Ensure the load is not connected.
- Ensure the output is off.



Note

Function setting F-89 (Show Version) can only be viewed, not edited.

Configuration settings F-90~F-95 cannot be edited in the Normal Function Settings. Use the Power On Configuration Settings. See page 22 for details.

Steps

1. Press the Function key. The function key will light up.
2. The display will show F-01 on the top and the configuration setting for F-01 on the bottom.

Function

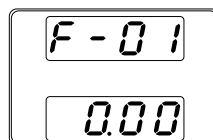

3. Rotate the voltage knob to change the F setting.

Range F-00~ F-61, F-88~F-89

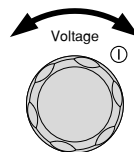

4. Use the current knob to set the parameter for the chosen F setting.

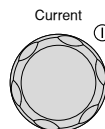

5. Press the Voltage knob to save the configuration setting. Conf will be displayed when successful.

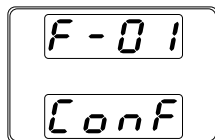
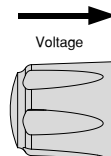

Exit

Press the Function key again to exit the configuration settings. The function key light will turn off.



Setting Power On Configuration Settings

Background

The Power On configuration settings can only be changed during power up to prevent the configuration settings being inadvertently changed.

- Ensure the load is not connected.
- Ensure the power supply is off.

Steps

6. Hold the Function key whilst turning the power on.
7. The display will show F-90 on the top and the configuration setting for F-90 on the bottom.

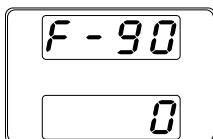
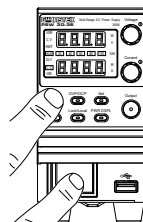

8. Rotate the voltage knob to change the F setting.
Range F-90~ F-95

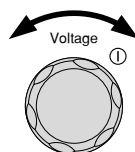

9. Use the current knob to set the parameter for the chosen F setting.

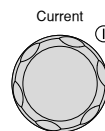

10. Press the Voltage knob to save the configuration setting. ConF will be displayed when successful.

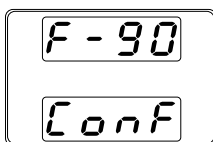
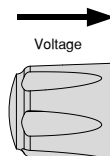

Exit

Cycle the power to save and exit the configuration settings.

Configuration Table

Please use the configuration settings listed below when applying the configuration settings.

Normal Function		
Settings	Setting	Setting Range
Output ON delay time	F-01	0.00s~99.99s
Output OFF delay time	F-02	0.00s~99.99s
V-I mode slew rate select	F-03	0 = CV high speed priority 1 = CC high speed priority 2 = CV slew rate priority 3 = CC slew rate priority
Rising voltage slew rate	F-04	0.01V/s~60.00V/s (PSW 30-XX) 0.1V/s~160.0V/s (PSW 80-XX) 0.1V/s~320.0V/s (PSW 160-XX) 0.1V/s~500.0V/s (PSW 250-XX) 1V/s~1600V/s (PSW 800-XX)
Falling voltage slew rate	F-05	0.01V/s~60.00V/s (PSW 30-XX) 0.1V/s~160.0V/s (PSW 80-XX) 0.1V/s~320.0V/s (PSW 160-XX) 0.1V/s~500.0V/s (PSW 250-XX) 1V/s~1600V/s (PSW 800-XX)
Rising current slew rate	F-06	0.01A/s~72.00A/s (PSW 30-36) 0.1A/s~144.0A/s (PSW 30-72) 0.1A/s~216.0A/s (PSW 30-108) 0.01A/s~27.00A/s (PSW 80-13.5) 0.01A/s~54.00A/s (PSW 80-27) 0.01A/s~81.00A/s (PSW 80-40.5) 0.01A/s~14.40A/s (PSW 160-7.2) 0.01A/s~28.80A/s (PSW 160-14.4) 0.01A/s~43.20A/s (PSW 160-21.6) 0.001A/s ~ 9.000A/s (PSW 250-4.5) 0.01A/s ~ 18.00A/s (PSW 250-9) 0.01A/s ~ 27.00A/s (PSW 250-13.5) 0.001A/s ~ 2.880A/s (PSW 800-1.44) 0.001A/s ~ 5.760A/s (PSW 800-2.88) 0.001A/s ~ 8.640A/s (PSW 800-4.32)

Falling current slew rate	F-07	0.01A/s~72.00A/s (PSW 30-36)
		0.1A/s~144.0A/s (PSW 30-72)
		0.1A/s~216.0A/s (PSW 30-108)
		0.01A/s~27.00A/s (PSW 80-13.5)
		0.01A/s~54.00A/s (PSW 80-27)
		0.01A/s~81.00A/s (PSW 80-40.5)
		0.01A/s~14.40A/s (PSW 160-7.2)
		0.01A/s~28.80A/s (PSW 160-14.4)
		0.01A/s~43.20A/s (PSW 160-21.6)
		0.001A/s ~ 9.000A/s (PSW 250-4.5)
		0.01A/s ~ 18.00A/s (PSW 250-9)
		0.01A/s ~ 27.00A/s (PSW 250-13.5)
		0.001A/s ~ 2.880A/s (PSW 800-1.44)
		0.001A/s ~ 5.760A/s (PSW 800-2.88)
0.001A/s ~ 8.640A/s (PSW 800-4.32)		
Internal resistance setting	F-08	0.000Ω~0.833Ω (PSW 30-36)
		0.000Ω~0.417Ω (PSW 30-72)
		0.000Ω~0.278Ω (PSW 30-108)
		0.000Ω~5.926Ω (PSW 80-13.5)
		0.000Ω~2.963Ω (PSW 80-27)
		0.000Ω~1.975Ω (PSW 80-40.5)
		0.000Ω~22.222Ω (PSW 160-7.2)
		0.000Ω~11.111Ω (PSW 160-14.4)
		0.000Ω~7.407Ω (PSW 160-21.6)
		0.00Ω ~ 55.55Ω (PSW 250-4.5)
		0.00Ω ~ 27.77Ω (PSW 250-9)
		0.00Ω ~ 18.51Ω (PSW 250-13.5)
		0.0Ω ~ 555.5Ω (PSW 800-1.44)
		0.0Ω ~ 277.8Ω (PSW 800-2.88)
0.0Ω ~ 185.1Ω (PSW 800-4.32)		
Bleeder circuit control	F-09	0 = OFF, 1 = ON, 2 = AUTO
Buzzer ON/OFF control	F-10	0 = OFF, 1 = ON
Measurement Average Setting	F-17	0 = Low, 1 = Middle, 2 = High
Lock Mode	F-19	0 = Panel lock: allow output off 1 = Panel lock: allow output on/off
USB/GPIB settings		
Front panel USB State	F-20	0 = Absent, 1 = Mass Storage
Rear panel USB State	F-21	0 = Absent, 2 = USB-CDC, 3 = GPIB-USB adapter

Rear panel USB mode	F-22	0 = Disable, 1 = GPIB-USB adapter, 2 = Auto detect speed, 3 = Full speed only
GPIB address	F-23	0~30
LAN settings		
MAC Address-1	F-30	0x00~0xFF
MAC Address-2	F-31	0x00~0xFF
MAC Address-3	F-32	0x00~0xFF
MAC Address-4	F-33	0x00~0xFF
MAC Address-5	F-34	0x00~0xFF
MAC Address-6	F-35	0x00~0xFF
LAN	F-36	0 = Disable, 1 = Enable
DHCP	F-37	0 = Disable, 1 = Enable
IP Address-1	F-39	0~255
IP Address-2	F-40	0~255
IP Address-3	F-41	0~255
IP Address-4	F-42	0~255
Subnet Mask-1	F-43	0~255
Subnet Mask-2	F-44	0~255
Subnet Mask-3	F-45	0~255
Subnet Mask-4	F-46	0~255
Gateway-1	F-47	0~255
Gateway-2	F-48	0~255
Gateway-3	F-49	0~255
Gateway-4	F-50	0~255
DNS address -1	F-51	0~255
DNS address -2	F-52	0~255
DNS address-3	F-53	0~255
DNS address-4	F-54	0~255
Sockets active	F-57	0 = Disable, 1 = Enable
Web Server active	F-59	0 = Disable, 1 = Enable
Web password active	F-60	0 = Disable, 1 = Enable
Web setting password	F-61	0000~9999
System Settings		
Factory Set Value	F-88	0 = Disable 1 = Return to factory settings

		0, 1 = PSW version 2, 3 = PSW build year 4, 5 = PSW build month/day 6, 7 = Keyboard CPLD version 8, 9 = Analog-Control CPLD version A, B = Reserved C, D = Kernel build year E, F = Kernel build month/day G, H = Test command version I, J = Test command build year K, L = Test command build month/day M, N = USB Driver version.
Show Version	F-89	
Power On Configuration Settings*		
CV Control	F-90	0 = Panel control (local) 1 = External voltage control 2 = External resistance control (Ext-R \searrow 10k Ω = Vo, max) 3 = External resistance control (Ext-R \nearrow 10k Ω = 0)
CC Control	F-91	0 = Panel control (local) 1 = External voltage control 2 = External resistance control (Ext-R \searrow 10k Ω = Io,max) 3 = External resistance control (Ext-R \nearrow 10k Ω = 0)
Power-ON Output	F-92	0 = OFF at startup 1 = ON at startup T001 ~ T010 = Run test script TXX at start up
Master/Slave	F-93	0 = Master/Local 1 = Master/Parallel1 2 = Master/Parallel2 3 = Slave/Parallel 4 = Slave/Series (Only 30V, 80V, 160V models)
External Out Logic	F-94	0 = High ON, 1 = Low ON
Power Switch trip	F-95	0 = Enable , 1 = Disable
Calibration Settings*		
Calibration	F-00	0000 ~ 9999



*Note

Power On and Calibration settings can only be set during power up.

REMOTE CONTROL

This chapter describes basic configuration of IEEE488.2 based remote control. For a command list, refer to the programming manual, downloadable from GW Instek website, www.gwinstek.com

Interface Configuration	30
Socket Server Examples	45
Command Syntax	49
Command List.....	52
Status Register Overview	95
Error List.....	106

Interface Configuration

USB Remote Interface	30
Configure GPIB Interface	31
Configure Ethernet Connection	32
USB Remote Control Function Check	34
Using Realterm to Establish a Remote Connection	35
Web Server Remote Control Function Check	39
Socket Server Function Check	39

USB Remote Interface

USB configuration	PC side connector	Type A, host
	PSW side connector	Rear panel Type B, slave
	Speed	1.1/2.0 (full speed/high speed)
	USB Class	CDC (communications device class)

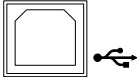
- Panel operation
1. Connect the USB cable to the rear panel USB B port. 
 2. Press the Function key to enter the Normal configuration settings. Page 21
- Set the following USB settings:
- F-22 = 2 Set the rear panel USB port to USB-CDC.

Configure GPIB Interface

To use GPIB, the optional GPIB to USB (GUG-001) adapter must be used. The GPIB to USB adapter must be connected before the PSW is turned on. Only one GPIB address can be used at a time.

- Configure GPIB
1. Ensure the PSW is off before proceeding.
 2. Connect the USB cable from the rear panel USB B port on the PSW to the USB A port on the GPIB to USB adapter.
 3. Connect a GPIB cable from a GPIB controller to the GPIB port on the adapter.

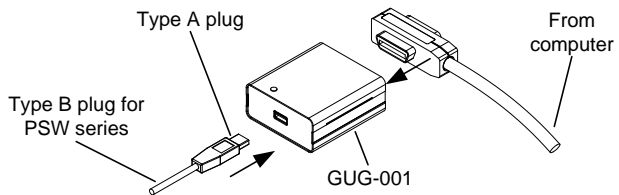

4. Turn the PSW on.
5. Press the Function key to enter the Page 21 Normal configuration settings.

Set the following GPIB settings:

- | | |
|-------------|---|
| F-22 = 1 | Set the rear panel USB port to GPIB-USB (GUG-001) |
| F-23 = 0~30 | Set the GPIB address (0~30) |
-

- GPIB constraints
- Maximum 15 devices altogether, 20m cable length, 2m between each device
 - Unique address assigned to each device
 - At least 2/3 of the devices turned On
 - No loop or parallel connection

Configure Ethernet Connection

The Ethernet interface can be configured for a number of different applications. Ethernet can be configured for basic remote control or monitoring using a web server or it can be configured as a socket server.

The PSW series supports both DHCP connections so the instrument can be automatically connected to an existing network or alternatively, network settings can be manually configured.

Ethernet
configuration
Parameters

For details on how to configure the Ethernet settings, please see the configuration table on page 24.

MAC Address (display only)	LAN
DHCP	IP Address
Subnet Mask	Gateway
DNS Address	Sockets Active
Web Server Active	Web Password Active
Web set password	0000~9999 (default 0000)

Web Server Configuration

Configuration

This configuration example will configure the PSW as a web server and use DHCP to automatically assign an IP address to the PSW.

1. Connect an Ethernet cable from the network to the rear panel Ethernet port.

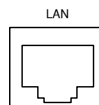

2. Press the Function key to enter the Page 21 Normal configuration settings.

Set the following LAN settings:

F-36 = 1	Enable LAN
F-37 = 1	Turn DHCP to enable
F-59 = 1	Turn the web server on



Note

It may be necessary to cycle the power or refresh the web browser to connect to a network.

Sockets Server Configuration

Configuration

This configuration example will configure the PSW sockets server.

The following configuration settings will manually assign the PSW an IP address and enable the socket server. By default, the socket server port number is 2268 and cannot be configured.

1. Connect an Ethernet cable from the network to the rear panel Ethernet port.

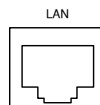

2. Press the Function key to enter the Page 21 Normal configuration settings.

3. Set the following LAN settings:

F-36 = 1	Enable LAN
F-37 = 0	Disable DHCP
F-39 = 172	IP Address part 1 of 4
F-40 = 16	IP Address part 2 of 4
F-41 = 5	IP Address part 3 of 4
F-42 = 133	IP Address part 4 of 4
F-43 = 255	Subnet Mask part 1 of 4

F-44 = 255	Subnet Mask part 2 of 4
F-45 = 128	Subnet Mask part 3 of 4
F-46 = 0	Subnet Mask part 4 of 4
F-43 = 172	Gateway part 1 of 4
F-44 = 16	Gateway part 2 of 4
F-45 = 21	Gateway part 3 of 4
F-46 = 101	Gateway part 4 of 4
F-57 = 1	Enable Sockets



Note

The socket function is only available for firmware version V1.12 or above. See the user manual to check your firmware version number.

USB Remote Control Function Check

Functionality check

Invoke a terminal application such as Realterm. The PSW will appear as a COM port on the PC.

To check the COM port No, see the Device Manager in the PC. For WinXP; Control panel → System → Hardware tab.



Note

If you are not familiar with using a terminal application to send/receive remote commands via a USB connection, please page 35(Using Realterm to Establish a Remote Connection) for more information.

Run this query command via the terminal after the instrument has been configured for USB remote control (page 30).

*idn?

This should return the Manufacturer, Model number, Serial number, and Firmware version in the following format.

GW-INSTEK,PSW-XXX-X,TW123456,01.00.20110101

Manufacturer: GW-INSTEK
Model number : PSW-3036
Serial number : TW123456
Firmware version : 01.00.20110101

Using Realterm to Establish a Remote Connection

Background Realterm is a terminal program that can be used to communicate with a device attached to the serial port of a PC or via an emulated serial port via USB.

The following instructions apply to version 2.0.0.70. Even though Realterm is used as an example to establish a remote connection, any terminal program can be used that has similar functionality.



Note

Realterm can be downloaded on Sourceforge.net free of charge.

For more information please see
<http://realterm.sourceforge.net/>

- Operation**
1. Download Realterm and install according to the instructions on the Realterm website.
 2. Connect the PSW via USB (page 30).
 3. Go to the Windows device manager and find the COM port number for the connection. For example, go to the Start menu > Control Panel > Device Manager

Double click the *Ports* icon to reveal the connected serial port devices and the COM port for the each connected device.

The baud rate, stop bit and parity settings can be viewed for the virtual COM port by right-clicking connected device and selecting the *Properties* option.

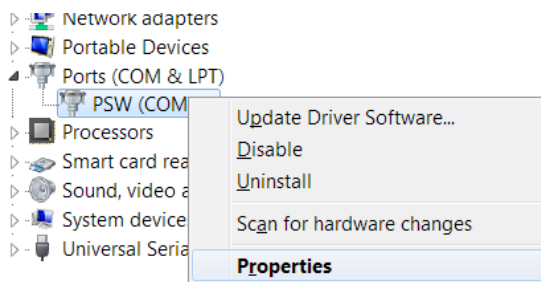

4. Start Realterm on the PC as an administrator.
Click:
Start menu>All Programs>RealTerm>realterm

Tip: to run as an administrator, you can right click the Realterm icon in the Windows Start menu and select the *Run as Administrator* option.

5. After Realterm has started, click on the *Port* tab.

Enter the *Baud*, *Parity*, *Data bits*, *Stop bits* and *Port* number configuration for the connection.

The *Hardware Flow Control*, *Software Flow Control* options can be left at the default settings.

Press *Open* to connect to the PSW.

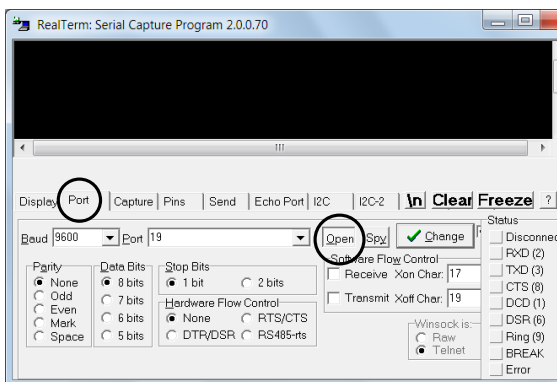

- Click on the *Send* tab.

In the *EOL* configuration, check on the *+CR* and *+LF* check boxes.

Enter the query:

**idn?*

Click on *Send ASCII*.

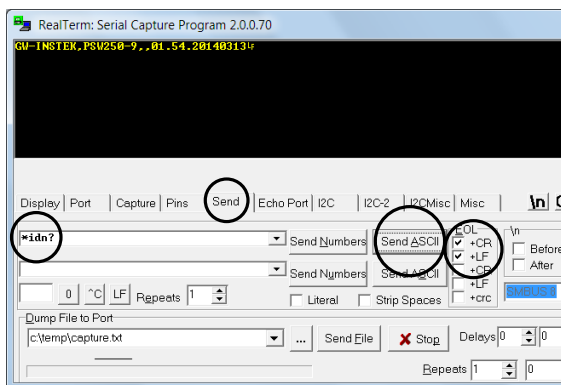

- The terminal display will return the following:

GW-INSTEK,PSW-XXX-X,TW123456,01.00.20110101

(manufacturer, model, serial number, version)

- If Realterm fails to connect to the PSW, please check all the cables and settings and try again.

Web Server Remote Control Function Check

Functionality check Enter the IP address of the power supply in a web browser after the instrument has been configured as a web server (page 32).

`http:// XXX.XXX.XXX.XXX`

The web browser interface appears.

Socket Server Function Check

Background To test the socket server functionality, National Instruments Measurement and Automation Explorer can be used. This program is available on the NI website, www.ni.com, via a search for the VISA Run-time Engine page, or “downloads” at the following URL, <http://www.ni.com/visa/>

Requirements Firmware: V1.12
Operating System: Windows XP, 7

Functionality check 1. Start the NI Measurement and Automation Explorer (MAX) program. Using Windows, press:

Start>All Programs>National Instruments>Measurement & Automation



2. From the Configuration panel access;
My System>Devices and Interfaces>Network Devices
3. Click *Create New...*
4. Select *Visa TCP/IP Resource*.

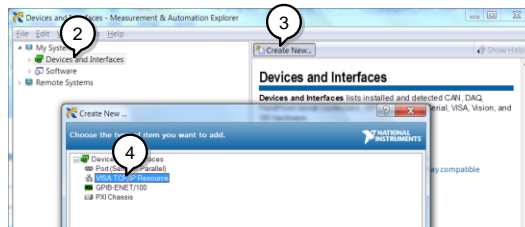

5. Select *Manual Entry of Raw Socket* from the popup window.
6. Click *Next*.

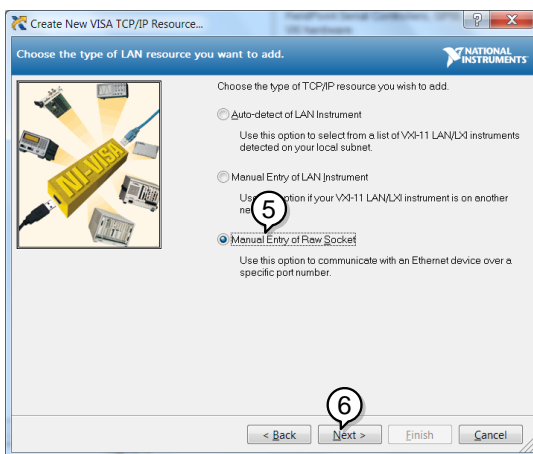

7. Enter the IP address and the port number of the PSW. The port number is fixed at 2268.
8. Click the Validate button. A popup box will appear when successful.
9. Click *Next*.

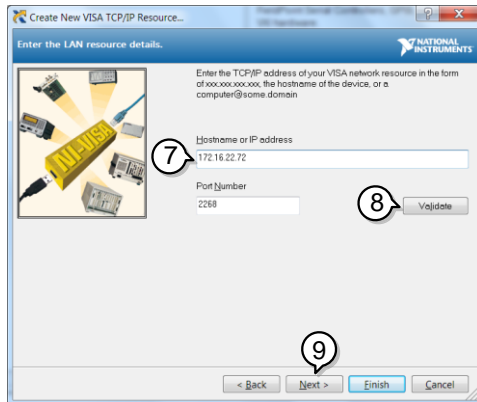

10. Next configure the Alias (name) of the PSW connection. In this example the Alias is: PSW_DC1

11. Click finish.

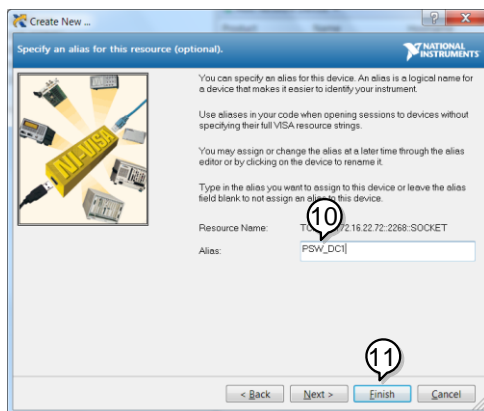

12. The IP address of the PSW will now appear under Network Devices in the configuration panel. Select this icon now.

13. Press *Open VISA Test Panel*.

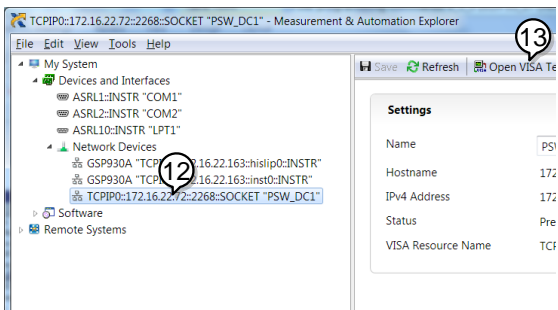

14. Click *Configuration* icon.
15. In the *I/O Settings* tab, select the *Enable Termination Character* check box. Ensure *Line Feed - \n* is selected as the line feed character.
16. Click *Apply Changes*.

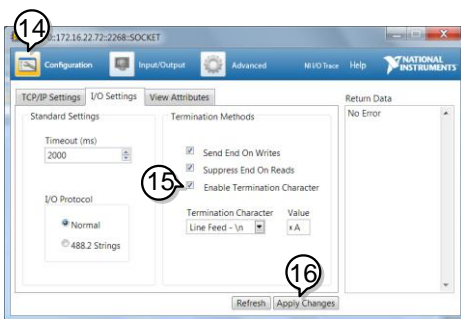

17. Click the *Input/Output* icon.
18. Ensure **IDN?\n* is selected in the *Select or Enter Command* dropdown text box.
19. Click the *Query* button.
20. The **IDN?* query should be returned to the buffer area:
 GW-INSTEK,PSW250-9,,01.54.20140313\n

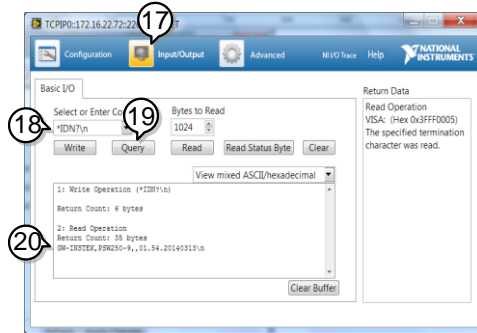

 **Note**

For further details, please see the following programming examples.

Socket Server Examples

Visual Basic Example.....	45
C++ Example.....	46
LabVIEW Example.....	48

Visual Basic Example

Background

The following visual basic programming example uses the VISA COM 3.0 Type Library. The example will connect to the PSW using the IP address of 172.15.5.133 over port 2268. The program will send the *IDN? to the PSW, print the return string and then close the connection.

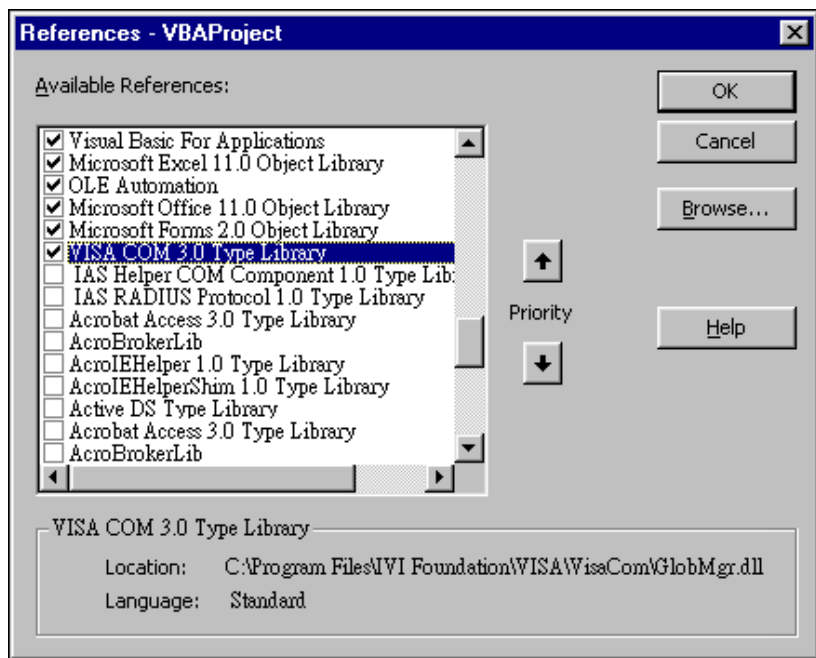

```
'Create VISA ResourceManager object
Dim rm As New VisaComLib.ResourceManager
Dim accessMode As VisaComLib.accessMode
Dim serial As String
Dim timeOut As Integer
Dim optionString As String
Dim psw As VisaComLib.IMessage
Dim pswcom As VisaComLib.FormattedIO488
Dim pswsfc As VisaComLib.IAsynchMessage

Private Sub CommandButton1_Click()
    accessMode = VisaComLib.accessMode.NO_LOCK

    timeOut = 0

    optionString = ""

    'Connect to the PSW

    Set psw = rm.Open("TCPIP0::172.16.5.133::2268::SOCKET", _
        accessMode, _
        timeOut, _
        optionString)
    Set pswsfc = psw
    pswsfc.TerminationCharacterEnabled = True

    'Query the System Identify Name
    psw.WriteString ("*IDN?" & vbCrLf)

    Worksheets("Sheet1").Cells(1, 5) = psw.ReadString(256)

    'Close the communication
    psw.Close

End Sub
```

C++ Example

Background The following program creates a connection to the PSW and sets the voltage to 3.3 volts and the current 1.5 amps. The voltage and current reading is then read back and the connection is closed.



Note

Add visa32.lib to the project library when building the following sample program.

```
#include "stdio.h"
#include "string.h"
#include "visatype.h"
#include "visa.h"
#define IPAddr "172.16.20.181"
int main(int argc, char* argv[])
{
    ViSession defaultRm, instr;
    // Create VISA ResourceManager object
    ViStatus status = viOpenDefaultRM(&defaultRm);
    if (status < VI_SUCCESS)
    {
        // Initialization error
        return -1;
    }
    ViChar rsc[256];
    sprintf(rsc, "TCPIP0::%s::2268::SOCKET", IPAddr);
    ViAccessMode accessMode = VI_NO_LOCK;
    ViUInt32 timeout = 0;
    // Connect the device
    viOpen(defaultRm, rsc, accessMode, timeout, &instr);
    /* Set the timeout for message-based communication */
    status = viSetAttribute(instr, VI_ATTR_TMO_VALUE, 5000);
    status = viSetAttribute(instr, VI_ATTR_TERMCHAR, 10);
    status = viSetAttribute(instr, VI_ATTR_TERMCHAR_EN, VI_TRUE);
    ViUInt32 count;
    // Set the Voltage to 3.3, Current to 1.5
    ViBuf buf = (ViBuf)":volt 3.3;:curr 1.5\n";
    viWrite(instr, buf, (ViUInt32)strlen((ViPChar)buf), &count);

    // Query the Voltage, and Current
    buf = (ViBuf)":apply?\n";
    status = viWrite(instr, buf, (ViUInt32)strlen((ViPChar)buf), &count);
    ViChar result[257];
    status = viRead(instr, (ViPBuf)result, 256, &count);
    if (status=VI_SUCCESS_TERM_CHAR)
    {
        result[count] = 0;
        printf("Voltage(V), Current(A)= %s\n", result);
    }else
        printf("Error\n");

    // Close the device
    viClose(instr);
    viClose(defaultRm);

    return 0;
}
```

LabVIEW Example

Background

The following picture shows a LabView programming example for the PSW.

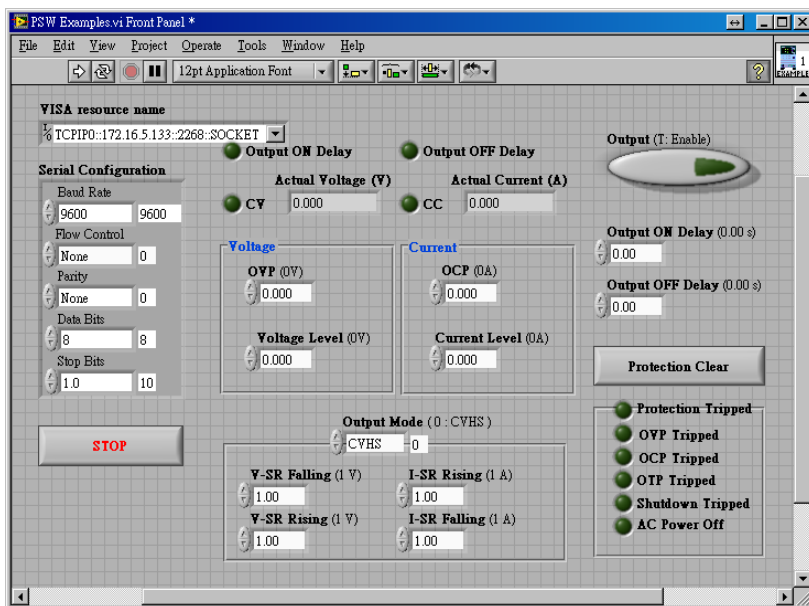

Command Syntax

Compatible Standard	IEEE488.2	Partial compatibility
	SCPI, 1999	Partial compatibility

Command Structure

SCPI commands follow a tree-like structure, organized into nodes. Each level of the command tree is a node. Each keyword in a SCPI command represents each node in the command tree. Each keyword (node) of a SCPI command is separated by a colon (:).

For example, the diagram below shows an SCPI sub-structure and a command example.

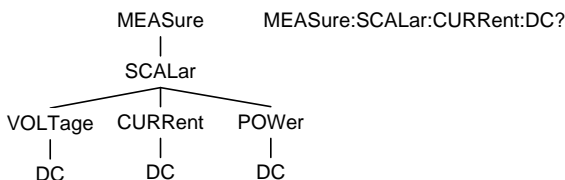

Command types

There are a number of different instrument commands and queries. A command sends instructions or data to the unit and a query receives data or status information from the unit.

Command types

Simple A single command with/without a parameter

Example *IDN?

Query A query is a simple or compound command followed by a question mark (?). A parameter (data) is returned.

Example meas:curr:dc?

Compound Two or more commands on the same command line. Compound commands are separated with either a semi-colon (;) or a semi-colon and a colon (;:).

A semi-colon is used to join two related commands, with the caveat that the last command must begin at the last node of the first command.

A semi-colon and colon are used to combine two commands from different nodes.

Example meas:volt:dc?::meas:curr:dc?

Command Forms Commands and queries have two different forms, long and short. The command syntax is written with the short form of the command in capitals and the remainder (long form) in lower case.

The commands can be written in capitals or lower-case, just so long as the short or long forms are complete. An incomplete command will not be recognized.

Below are examples of correctly written commands.

Long form	STATus:OPERation:NTRansition? STATUS:OPERATION:NTRANSITION? status:operation:ntransition?
Short form	STAT:OPER:NTR? stat:oper:ntr?

Square Brackets Commands that contain square brackets indicate that the contents are optional. The function of the command is the same with or without the square bracketed items, as shown below.

Both “DISPlay:MENU[:NAME]?” and “DISPlay:MENU?” are both valid forms.

Command Format

APPLY 1.5,5.2

1. Command header
2. Space
3. Parameter 1
4. Comma (no space before/after comma)
5. Parameter 2

Parameters	Type	Description	Example
	<Boolean>	Boolean logic	0, 1

<NR1>	integers	0, 1, 2, 3
<NR2>	decimal numbers	0.1, 3.14, 8.5
<NR3>	floating point	4.5e-1, 8.25e+1
<NRF>	any of NR1, 2, 3	1, 1.5, 4.5e-1
<block data>	Definitive length arbitrary block data. A single decimal digit followed by data. The decimal digit specifies how many 8-bit data bytes follow.	

Message Terminator	LF	Line feed code
--------------------	----	----------------

Command List

Abort Commands	ABORT	56
Apply Commands	APPLY	56
Display Commands	DISPlay:MENU[:NAME]	57
	DISPlay[:WINDow]:TEXT:CLEAr	58
	DISPlay[:WINDow]:TEXT[:DATA]	58
	DISPlay:BLINK	58
Initiate Commands	INITiate[:IMMEDIATE]:NAME	59
Measure Commands	MEASure[:SCALar]:CURRent[:DC]	60
	MEASure[:SCALar]:VOLTage[:DC]	60
	MEASure[:SCALar]:POWer[:DC]	60

Output	OUTPut:DELAy:ON.....	61
Commands	OUTPut:DELAy:OFF.....	61
	OUTPut:MODE.....	62
	OUTPut[:STATe][:IMMediate].....	62
	OUTPut[:STATe]:TRIGgered.....	62
	OUTPut:PROTection:CLEar.....	63
	OUTPut:PROTection:TRIPped.....	63
Sense	SENSe:AVERAge:COUNT.....	64
Commands		
Status	STATus:OPERation[:EVENT].....	65
Commands	STATus:OPERation:CONDition.....	65
	STATus:OPERation:ENABle.....	65
	STATus:OPERation:PTRansition.....	66
	STATus:OPERation:NTRansition.....	66
	STATus:QUEStionable[:EVENT].....	66
	STATus:QUEStionable:CONDition.....	67
	STATus:QUEStionable:ENABle.....	67
	STATus:QUEStionable:PTRansition.....	67
	STATus:QUEStionable:NTRansition.....	67
STATus:PRESet.....	68	
Source	[SOURce:]CURRent[:LEVel][:IMMediate][:AMPLitude]	69
Commands	[SOURce:]CURRent[:LEVel]:TRIGgered[:AMPLitude]..	70
	[SOURce:]CURRent:PROTection[:LEVel].....	70
	[SOURce:]CURRent:PROTection:STATe.....	71
	[SOURce:]CURRent:SLEW:RISing.....	71
	[SOURce:]CURRent:SLEW:FALLing.....	72
	[SOURce:]RESistance[:LEVel][:IMMediate]	
	[:AMPLitude].....	72
	[SOURce:]VOLTAge[:LEVel][:IMMediate]	
	[:AMPLitude].....	73
	[SOURce:]VOLTAge[:LEVel]:TRIGgered[:AMPLitude].	74
	[SOURce:]VOLTAge:PROTection[:LEVel].....	74
	[SOURce:]VOLTAge:SLEW:RISing.....	74
	[SOURce:]VOLTAge:SLEW:FALLing.....	75

Trigger	TRIGger:TRANsient[:IMMediate].....	76
Commands	TRIGger:TRANsient:SOURce.....	76
	TRIGger:OUTPut[:IMMediate].....	77
	TRIGger:OUTPut:SOURce.....	77
	Trigger Command Examples.....	77
System	SYSTem:BEEPer[:IMMediate].....	80
Commands	SYSTem:CONFigure:BEEPer[:STATe].....	80
	SYSTem:CONFigure:BLEeder[:STATe].....	81
	SYSTem:CONFigure:BTRip[:IMMediate].....	81
	SYSTem:CONFigure:BTRip:PROTection.....	81
	SYSTem:CONFigure:CURREnt:CONTRol.....	82
	SYSTem:CONFigure:VOLTAge:CONTRol.....	82
	SYSTem:CONFigure:MSLave.....	83
	SYSTem:CONFigure:OUTPut:EXTernal[:MODE].....	83
	SYSTem:CONFigure:OUTPut:PON[:STATe].....	84
	SYSTem:COMMunicate:ENABLE.....	84
	SYSTem:COMMunicate:GPIB[:SELF]:ADDReSS.....	85
	SYSTem:COMMunicate:LAN:IPADdress.....	85
	SYSTem:COMMunicate:LAN:GATEway.....	85
	SYSTem:COMMunicate:LAN:SMASk.....	86
	SYSTem:COMMunicate:LAN:MAC.....	86
	SYSTem:COMMunicate:LAN:DHCP.....	86
	SYSTem:COMMunicate:LAN:DNS.....	87
	SYSTem:COMMunicate:LAN:HOSTname.....	87
	SYSTem:COMMunicate:LAN:WEB:PACTive.....	87
	SYSTem:COMMunicate:LAN:WEB:PASSword.....	88
	SYSTem:COMMunicate:RLState.....	88
	SYSTem:COMMunicate:USB:FRONt:STATe.....	89
	SYSTem:COMMunicate:USB:REAR:STATe.....	89
	SYSTem:COMMunicate:USB:REAR:MODE.....	89
	SYSTem:ERRor.....	89
	SYSTem:KEYLock:MODE.....	90
	SYSTem:KLOCK.....	90
	SYSTem:INFormation.....	90
	SYSTem:PRESet.....	91
	SYSTem:VERSiOn.....	91

Common	*CLS	92
Commands	*ESE	92
	*ESR	92
	*IDN	92
	*OPC	93
	*RST	93
	*SRE	93
	*STB	94
	*TRG	94
	*TST	94
	*WAI	94

Abort Commands

ABORt	56
-------------	----

ABORt



Description	The ABORt command will cancel any triggered actions.
Syntax	ABORt

APPLY Commands

APPLY	56
-------------	----

APPLY

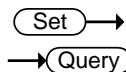

Description	<p>The APPLY command is used to set both the voltage and current. The voltage and current will be output as soon as the function is executed if the programmed values are within the accepted range. An execution error will occur if the programmed values are not within accepted ranges.</p> <p>The Apply command will set the voltage/current values but these values will not be reflected on the display until the Output is On or if the DISPlay:MENU:NAME 3 (set menu) command is used.</p>
Syntax	APPLY {<voltage> MIN MAX}[,{<current> MIN MAX}]
Query Syntax	APPLY?

Parameter	<voltage>	<NRf> 0% ~ 105% of the rated output voltage.
	<current>	<NRf> 0% ~ 105% of the rated output current.
	MIN	0 volts/0 amps
	MAX	Maxium value for the present range.
Return parameter	<NRf>	Returns the voltage and current.
Example	APPL 5.05,1.1	
		Sets the voltage and current to 5.05V and 1.1A.
Query Example	APPL?	
	+5.050, +1.100	
		Returns voltage (5.05V) and current (1.1A) setting.

Display Commands

DISPlay:MENU[:NAME]	57
DISPlay[:WINDow]:TEXT:CLEAr.....	58
DISPlay[:WINDow]:TEXT[:DATA].....	58
DISPlay:BLINK.....	58



Description	The DISPlay MENU command selects a screen menu or queries the current screen menu.	
Syntax	DISPlay:MENU[:NAME] <NR1>	
Query Sytax	DISPlay:MENU[:NAME]?	
Parameter/ Return parameter	<NR1>	Description
	0	Measurement-Voltage / Measurement-Current
	1	Measurement-Voltage / Measurement-Power
	2	Measurement-Power / Measurement-Current
	3	Set Menu
	4	OVP / OCP Menu
	5~99	Not Used.
	100~199	F-00~99 Menu.

Example `DISP:MENU:NAME 0`
 Sets the display to the Voltage/Current display screen.

DISPlay[:WINDow]:TEXT:CLEar (Set) →

Description Clears the text on the main screen from the `DISPlay[:WINDow]:TEXT[:DATA]` command .

Syntax `DISPlay[:WINDow]:TEXT:CLEar`

(Set) →

DISPlay[:WINDow]:TEXT[:DATA] → (Query)

Description Sets or queries the data text that will be written to the display. Writing to the display will overwrite data that is currently on the screen. Overwriting a display area with a shorter string may or may not overwrite the screen. The string must be enclosed in quotes: "STRING". Only ASCII characters 20H to 7EH can be used in the <string>.

Syntax `DISPlay[:WINDow]:TEXT[:DATA] <string>`

Query Syntax `DISPlay[:WINDow]:TEXT[:DATA]?`

**Parameter/
Return parameter** <string> ASCII character 20H to 7EH can be used to in the string parameter. The string must be enclosed in quotes: "STRING"

Example `DISP:WIND:TEXT:DATA "STRING"`
 Writes STRING to the display.

Query Example `DISP:WIND:TEXT:DATA?`
 "STRING"
 Returns the text data string on the screen.

(Set) →

DISPlay:BLINK → (Query)

Description Turns blink on or off for the display.

Syntax `DISPlay:BLINK { 0 | 1 | OFF | ON }`

Query Syntax `DISPlay:BLINK?`

Parameter	0	<NR1>Turns blink OFF
	OFF	Turns blink OFF
	1	<NR1> Turns blink ON
	ON	Turns blink ON
Return parameter	0	<NR1>Turns blink OFF
	1	<NR1>Turns blink ON
Example	DISP:BLIN 1 Turns blink ON.	

Initiate Commands

INITiate[:IMMEDIATE]:NAME 59

INITiate[:IMMEDIATE]:NAME (Set) →

Description	The INITiate command starts the TRANSient or OUTPut trigger. See the trigger commands on page 76 for usage details.	
Syntax	INITiate[:IMMEDIATE]:NAME {TRANSient OUTPut}	
Parameter	TRANSient	Starts the TRANSient trigger.
	OUTPut	Starts the OUTPut trigger.
Example	INITiate:NAME TRANient Starts the TRANSient trigger.	

Measure Commands

MEASure[:SCALar]:CURRent[:DC]	60
MEASure[:SCALar]:VOLTage[:DC]	60
MEASure[:SCALar]:POWer[:DC]	60

MEASure[:SCALar]:CURRent[:DC] → Query

Description Takes a measurement and returns the average output current

Syntax MEASure[:SCALar]:CURRent[:DC]?

Return parameter <NRf> Returns the current in amps.

MEASure[:SCALar]:VOLTage[:DC] → Query

Description Takes a measurement and returns the average output voltage.

Syntax MEASure[:SCALar]:VOLTage[:DC]?

Return <NRf> Returns the voltage in volts.

MEASure[:SCALar]:POWer[:DC] → Query

Description Takes a measurement and returns the average output power.

Syntax MEASure[:SCALar]:POWer[:DC]?

Return <NRf> Returns the power measured in watts.

Output Commands

OUTPut:DELAy:ON.....	61
OUTPut:DELAy:OFF.....	61
OUTPut:MODE.....	62
OUTPut[:STATe][:IMMediate].....	62
OUTPut[:STATe]:TRIGgered.....	62
OUTPut:PROTEction:CLEar.....	63
OUTPut:PROTEction:TRIPped.....	63

OUTPut:DELAy:ON

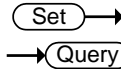

Description	Sets the Delay Time in seconds for turning the output on. The delay is set to 0.00 by default.
Syntax	OUTPut:DELAy:ON <NRf>
Query Syntax	OUTPut:DELAy:ON?
Parameter	<NRf> 0.00~99.99 seconds, where 0=no delay.
Return parameter	<NRf> Returns the delay on time in seconds until the output is turned on.

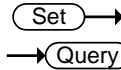

OUTPut:DELAy:OFF

Description	Sets the Delay Time in seconds for turning the output off. The delay is set to 0.00 by default.
Syntax	OUTPut:DELAy:OFF <NRf>
Return Syntax	OUTPut:DELAy:OFF?
Parameter	<NRf> 0.00~99.99 seconds, where 0=no delay.
Return parameter	<NRf> Returns the delay off time in seconds until the output is turned off.

OUTPut:MODE

Set →

→ Query

Description	Sets the PSW output mode. This is the equivalent to the F-03 (V-I Mode Slew Rate Select) settings.	
Syntax	OUTPut:MODE {<NR1> CVHS CCHS CVLS CCLS}	
Return Syntax	OUTPut:MODE?	
Parameter	0	CV high speed priority
	CVHS	CV high speed priority
	1	CC high speed priority
	CCHS	CC high speed priority
	2	CV slew rate priority
	CVLS	CV slew rate priority
	3	CC slew rate priority
	CCLS	CC slew rate priority
Return parameter	<NR1>	Returns the output mode.

OUTPut[:STATe][:IMMediate]

Set →

→ Query

Description	Turns the output on or off.	
Syntax	OUTPut[:STATe][:IMMediate] { OFF ON 0 1 }	
Query Syntax	OUTPut[:STATe][:IMMediate]?	
Parameter	0	<NR1> Turns the output off.
	OFF	Turns the output off.
	1	<NR1> Turns the output on.
	ON	Turns the output on.
Return parameter	<NR1>	Returns output status of the instrument.

OUTPut[:STATe]:TRIGgered

Set →

→ Query

Description	Turns the output on or off when a software trigger is generated.	
Syntax	OUTPut[:STATe]:TRIGgered { OFF ON 0 1 }	
Query Syntax	OUTPut[:STATe]:TRIGgered?	

Parameter	0	<NR1>Turns the output off when a software trigger is generated.
	OFF	Turns the output off when a software trigger is generated.
	1	<NR1>Turns the output on when a software trigger is generated.
	ON	Turns the output on when a software trigger is generated.
Return parameter	<NR1>	Returns output trigger status of the instrument.

OUTPut:PROTEction:CLEar

Set →

Description	Clears over-voltage, over-current and over-temperature (OVP, OCP, OTP) protection circuits. It also clears the shutdown protection circuit. The AC failure protection cannot be cleared.
Syntax	OUTPut:PROTEction:CLEar

OUTPut:PROTEction:TRIPped

→ Query

Description	Returns the state of the protection circuits (OVP, OCP, OTP).	
Query Syntax	OUTPut:PROTEction:TRIPped?	
Return parameter	0	<NR1>Protection circuits are not tripped.
	1	<NR1>Protection circuits are tripped.

Sense Commands

SENSe:AVERAge:COUNT 64

SENSe:AVERAge:COUNT

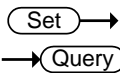

Description	Determines the level of smoothing for the average setting. This is the equivalent to the F-17 function setting.	
Syntax	SENSe:AVERAge:COUNT {<NR1> LOW MIDDLE HIGH}	
Query Syntax	SENSe:AVERAge:COUNT?	
Parameter	0 LOW	Low level of smoothing.
	1 MIDDLE	Middle level of smoothing.
	2 HIGH	High level of smoothing.
Return parameter	<NR1>	Returns the level of smoothing.
	0	Low level of smoothing.
	1	Middle level of smoothing.
	2	High level of smoothing.
Example	SENSe:AVERAge:COUNT 1 Sets the level of smoothing to middle.	

Status Commands

STATus:OPERation[:EVENT]	65
STATus:OPERation:CONDition	65
STATus:OPERation:ENABle	65
STATus:OPERation:PTRansition	66
STATus:OPERation:NTRansition	66
STATus:QUEStionable[:EVENT]	66
STATus:QUEStionable:CONDition	67
STATus:QUEStionable:ENABle	67
STATus:QUEStionable:PTRansition	67
STATus:QUEStionable:NTRansition	67
STATus:PRESet	68

STATus:OPERation[:EVENT] → Query

Description Queries the Operation Status Event register and clears the contents of the register.

Syntax STATus:OPERation[:EVENT]?

Return <NR1> Returns the bit sum of the Operation Status Event register.

STATus:OPERation:CONDition → Query

Description Queries the Operation Status register. This query will not clear the register.

Syntax STATus:OPERation:CONDition?

Return <NR1> Returns the bit sum of the Operation Condition register.

Set →

STATus:OPERation:ENABle → Query

Description Sets or queries the bit sum of the Operation Status Enable register.

Syntax STATus:OPERation:ENABle <NRf>

Query Syntax STATus:OPERation:ENABle?

Parameter <NRf> 0~32767

Return parameter <NR1> 0~32767

Set →

→ Query

STATus:OPERation:PTRansition

Description Sets or queries the bit sum of the positive transition filter of the Operation Status register.

Syntax STATus:OPERation:PTRansition <NRf>

 STATus:OPERation:PTRansition?

Parameter <NRf> 0~32767

Return parameter <NR1> 0~32767

Set →

→ Query

STATus:OPERation:NTRansition

Description Sets or queries the bit sum of the negative transition filter of the Operation Status register.

Syntax STATus:OPERation:NTRansition <NRf>

Query Syntax STATus:OPERation:NTRansition?

Parameter <NRf> 0~32767

Return parameter <NR1> 0~32767

STATus:QUESTIONable[:EVENT]

→ Query

Description Queries the bit sum of the Questionable Status Event register. This query will also clear the contents of the register.

Query Syntax STATus:QUESTIONable[:EVENT]?

Parameter <NRf> 0~32767

Return parameter <NR1> 0~32767

STATus:QUEStionable:CONDition → **Query**

Description Queries the status (bit sum) of the Questionable Status register. This query will not clear the register.

Query Syntax STATus:QUEStionable:CONDition?

Parameter <NRf> 0~32767

Return parameter <NR1> 0~32767

→ **Set**

STATus:QUEStionable:ENABLE → **Query**

Description Sets or queries the bit sum of the Questionable Status Enable register.

Syntax STATus:QUEStionable:ENABLE <NRf>

Query Syntax STATus:QUEStionable:ENABLE?

Parameter <NRf> 0~32767

Return parameter <NR1> 0~32767

→ **Set**

STATus:QUEStionable:PTRansition → **Query**

Description Sets or queries the bit sum of the positive transition filter of the Questionable Status register.

Syntax STATus:QUEStionable:PTRansition <NRf>

Return Syntax STATus:QUEStionable:PTRansition?

Parameter <NRf> 0~32767

Return parameter <NR1> 0~32767

→ **Set**

STATus:QUEStionable:NTRansition → **Query**

Description Sets or queries the negative transition filter of the Questionable Status register.

Syntax STATus:QUEStionable:NTRansition <NRf>

Query Syntax STATus:QUEStionable:NTRansition?

Parameter	<NRF>	0~32767
Return parameter	<NR1>	0~32767

STATus:PRESet



Description This command resets the ENABle register, the PTRansition filter and NTRansition filter on the Operation Status and Questionable Status Registers. The registers/filters will be reset to a default value.

Default Register/Filter Values	Setting
QUEStionable Status Enable	0x0000
QUEStionable Status Positive Transition	0x7FFF
QUEStionable Status Negative Transition	0x0000
Operation Status Enable	0x0000
Operation Status Positive Transition	0x7FFF
Operation Status Negative Transition	0x0000

Summary: The Questionable Status Enable registers and the Operation Status Enable registers are both reset to 0.

The Questionable Status and Operation Status Positive Transition filters are all set high (0x7FFF) and the Negative Transition filters are all set low (0x0000). I.e., only positive transitions will be recognized for the Questionable Status and Operation Status registers.

Syntax STATus:PRESet

Source Commands

[SOURce:]CURRent[:LEVel][:IMMediate][:AMPLitude]	69
[SOURce:]CURRent[:LEVel]:TRIGgered[:AMPLitude]	70
[SOURce:]CURRent:PROTection[:LEVel]	70
[SOURce:]CURRent:PROTection:STATe	71
[SOURce:]CURRent:SLEW:RISing	71
[SOURce:]CURRent:SLEW:FALLing	72
[SOURce:]RESistance[:LEVel][:IMMediate][:AMPLitude]	72
[SOURce:]VOLTage[:LEVel][:IMMediate][:AMPLitude]	73
[SOURce:]VOLTage[:LEVel]:TRIGgered[:AMPLitude]	74
[SOURce:]VOLTage:PROTection[:LEVel]	74
[SOURce:]VOLTage:SLEW:RISing	74
[SOURce:]VOLTage:SLEW:FALLing	75

[SOURce:]CURRent[:LEVel][:IMMediate] Set →
[:AMPLitude] ← Query

Description	Sets or queries the current level in amps. For externally set current levels (from the analog control connector) the set current level is returned.						
Syntax	[SOURce:]CURRent[:LEVel][:IMMediate][:AMPLitude] {<NRf> MIN MAX}						
Query Syntax	[SOURce:]CURRent[:LEVel][:IMMediate][:AMPLitude]? [MIN MAX]						
Parameter/Return	<table> <tr> <td><NRf></td> <td>0~105% of the rated current output level.</td> </tr> <tr> <td>MIN</td> <td>Minimum current level.</td> </tr> <tr> <td>MAX</td> <td>Maximum current level.</td> </tr> </table>	<NRf>	0~105% of the rated current output level.	MIN	Minimum current level.	MAX	Maximum current level.
<NRf>	0~105% of the rated current output level.						
MIN	Minimum current level.						
MAX	Maximum current level.						
Example	<p>SOUR:CURR:LEV:IMM:AMPL? MAX</p> <p>37.800</p> <p>Returns the maximum possible current level in amps.</p>						

[SOURce:]CURRent[:LEVel]:TRIGgered (Set) →
 [:AMPLitude] → (Query)

Description	Sets or queries the current level in amps when a software trigger has been generated.	
Syntax	[SOURce:]CURRent[:LEVel]:TRIGgered[:AMPLitude] {<NRf> MIN MAX}	
Query Syntax	[SOURce:]CURRent[:LEVel]:TRIGgered[:AMPLitude]? [MIN MAX]	
Parameter/Return	<NRf>	0%~105% of the rated current output in amps.
	MIN	Minimum current level.
	MAX	Maximum current level.
Example	SOUR:CURR:LEV:TRIG:AMPL? MAX 37.800 Returns the maximum possible current level in amps.	

[SOURce:]CURRent:PROTection[:LEVel] (Set) →
→ (Query)

Description	Sets or queries the OCP (over-current protection) level in amps.	
Syntax	[SOURce:]CURRent:PROTection[:LEVel] {<NRf> MIN MAX}	
Query Syntax	[SOURce:]CURRent:PROTection[:LEVel]? [MIN MAX]	
Parameter/Return	<NRf>	OCP range in Amps.
	MIN	Minimum current level.
	MAX	Maximum current level.
Example	SOUR:CURR:PROT:LEV? MIN +3.600 Returns the minimum possible current level in amps.	

[SOURce:]CURRent:PROTection:STATe
 →
 →

Description	Turns OCP (over-current protection) on or off.	
Syntax	[SOURce:]CURRent:PROTection:STATe {0 1 OFF ON}	
Query Syntax	[SOURce:]CURRent:PROTection:STATe?	
Parameter/Return	0	<NR1> Turns the buzzer off.
	OFF	Turns the OCP off.
	1	<NR1> Turns the OCP on.
	ON	Turns the OCP on.
Return parameter	<Bool>	Returns the protection status (0 or 1).
Example	SOUR:CURR:PROT:STAT OFF Turns OCP off.	

[SOURce:]CURRent:SLEW:RISing
 →
 →

Description	Sets or queries the rising current slew rate. This is only applicable for CC slew rate priority mode.	
Syntax	[SOURce:]CURRent:SLEW:RISing {<NRf> MIN MAX}	
Query Syntax	[SOURce:]CURRent:SLEW:RISing? [MIN MAX]	
Parameter/Return	<NRf>	0.01A/s~72.00A/s (PSW 30-36)
		0.1A/s~144.0A/s (PSW 30-72)
		0.1A/s~216.0A/s (PSW 30-108)
		0.01A/s~27.00A/s (PSW 80-13.5)
		0.01A/s~54.00A/s (PSW 80-27)
		0.01A/s~81.00A/s (PSW 80-40.5)
		0.01A/s~14.40A/s (PSW 160-7.2)
		0.01A/s~28.80A/s (PSW 160-14.4)
		0.01A/s~43.20A/s (PSW 160-21.6)
		0.001A/s ~ 9.000A/s (PSW 250-4.5)
		0.01A/s ~ 18.00A/s (PSW 250-9)
		0.01A/s ~ 27.00A/s (PSW 250-13.5)
		0.001A/s ~ 2.880A/s (PSW 800-1.44)
		0.001A/s ~ 5.760A/s (PSW 800-2.88)
		0.001A/s ~ 8.640A/s (PSW 800-4.32)
	MIN	Minimum rising current slew rate.
	MAX	Maximum rising current slew rate.

Query Syntax [SOURce:]RESistance[:LEVel][:IMMediate][:AMPLitude]
? [MIN|MAX]

Parameter/Return	<NRf>	Resistance in ohms: 0.000Ω~0.833Ω (PSW 30-36) 0.000Ω~0.417Ω (PSW 30-72) 0.000Ω~0.278Ω (PSW 30-108) 0.000Ω~5.926Ω (PSW 80-13.5) 0.000Ω~2.963Ω (PSW 80-27) 0.000Ω~1.975Ω (PSW 80-40.5) 0.000Ω~22.222Ω (PSW 160-7.2) 0.000Ω~11.111Ω (PSW 160-14.4) 0.000Ω~7.407Ω (PSW 160-21.6) 0.00Ω ~ 55.55Ω (PSW 250-4.5) 0.00Ω ~ 27.77Ω (PSW 250-9) 0.00Ω ~ 18.51Ω (PSW 250-13.5) 0.0Ω ~ 555.5Ω (PSW 800-1.44) 0.0Ω ~ 277.8Ω (PSW 800-2.88) 0.0Ω ~ 185.1Ω (PSW 800-4.32)
	MIN	Minimum internal resistance in ohms
	MAX	Maximum internal resistance in ohms

Example SOUR:RES:LEV:IMM:AMPL 0.1
Sets the internal resistance to 100mΩ.

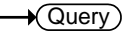
[SOURce:]VOLTage[:LEVel][:IMMediate] 
[:AMPLitude] 

Description	Sets or queries the voltage level in volts.	
Syntax	[SOURce:]VOLTage[:LEVel][:IMMediate][:AMPLitude]	{<NRf> MIN MAX}
Query Syntax	[SOURce:]VOLTage[:LEVel][:IMMediate][:AMPLitude]?	[MIN MAX]
Parameter/Return	<NRf>	0~105% of the rated output voltage in volts.
	MIN	Minimum voltage level
	MAX	Maximum voltage level

Example SOUR:VOLT:LEV:IMM:AMPL 10
Sets the voltage level to 10 volts.

[SOURce:]VOLTage[:LEVel]:TRIGgered (Set) →
[:AMPLitude] → (Query)

Description	Sets or queries the voltage level in volts when a software trigger has been generated.	
Syntax	[SOURce:]VOLTage[:LEVel]:TRIGgered[:AMPLitude] {<NRf> MIN MAX}	
Query Syntax	[SOURce:]VOLTage[:LEVel]:TRIGgered[:AMPLitude]? [MIN MAX]	
Parameter/Return	<NRf>	0%~105% of the rated voltage output in volts.
	MIN	Minimum current level.
	MAX	Maximum current level.
Example	SOUR:VOLT:LEV:TRIG:AMPL 10 Sets the voltage level to 10 volts when a software trigger is generated.	

[SOURce:]VOLTage:PROTection[:LEVel] (Set) →
→ (Query)

Description	Sets or queries the overvoltage protection level.	
Syntax	[SOURce:]VOLTage:PROTection[:LEVel] {<NRf> MIN MAX}	
Query Syntax	[SOURce:]VOLTage:PROTection[:LEVel]? [MIN MAX]	
Parameter/Return	<NRf>	OVP range in volts.
	MIN	Minimum OVP level
	MAX	Maximum OVP level
Example	SOUR:VOLT:PROT:LEV MAX Sets the OVP level to its maximum.	

[SOURce:]VOLTage:SLEW:RISing (Set) →
→ (Query)

Description	Sets or queries the rising voltage slew rate. This is only applicable for CV slew rate priority mode.	
-------------	---	--

Syntax [SOURce:]VOLTage:SLEW:RISing {<NRf>|MIN|MAX}

Query Syntax [SOURce:]VOLTage:SLEW:RISing? [MIN|MAX]

Parameter/Return	<NRf>	0.01V/s~60.00V/s (PSW 30-XX) 0.1V/s~160.0V/s (PSW 80-XX) 0.1V/s~320.0V/s (PSW 160-XX) 0.1V/s~500.0V/s (PSW 250-XX) 1V/s~1600V/s (PSW 800-XX)
	MIN	Minimum rising voltage slew rate.
	MAX	Maximum rising voltage slew rate.

Example SOUR:VOLT:SLEW:RIS MAX
Sets the rising voltage slew rate to its maximum.

[SOURce:]VOLTage:SLEW:FALLing (Set) →
← (Query)

Description Sets or queries the falling voltage slew rate. This is only applicable for CV slew rate priority mode.

Syntax [SOURce:]VOLTage:SLEW:FALLing {<NRf>|MIN|MAX}

Query Syntax [SOURce:]VOLTage:SLEW:FALLing? [MIN|MAX]

Parameter/Return	<NRf>	0.01V/s~60.00V/s (PSW 30-XX) 0.1V/s~160.0V/s (PSW 80-XX) 0.1V/s~320.0V/s (PSW 160-XX) 0.1V/s~500.0V/s (PSW 250-XX) 1V/s~1600V/s (PSW 800-XX)
	MIN	Minimum voltage falling slew rate.
	MAX	Maximum voltage falling slew rate.

Example SOUR:VOLT:SLEW:FALL MIN
Sets the falling voltage slew rate to its minimum.

Trigger Commands

The trigger commands generate and configure software triggers.

TRIGger:TRANsient[:IMMediate].....	76
TRIGger:TRANsient:SOURce.....	76
TRIGger:OUTPut[:IMMediate]	77
TRIGger:OUTPut:SOURce.....	77
Trigger Command Examples	77

TRIGger:TRANsient[:IMMediate] (Set) →

Description	Generates a software trigger for the transient trigger system. On a trigger, sets the voltage & current. Refer to the :CURR:TRIG and VOLT:TRIG commands on page 70 and 74, respectively.
-------------	--

Syntax	TRIGger:TRANsient[:IMMediate]
--------	-------------------------------

Related Commands	[SOURce:]CURRent[:LEVel]:TRIGgered[:AMPLitude] [SOURce:]VOLTage[:LEVel]:TRIGgered[:AMPLitude]
------------------	--

(Set) →

TRIGger:TRANsient:SOURce → (Query)

Description	Sets or queries the trigger source for the transient system.
-------------	--

Syntax	TRIGger:TRANsient:SOURce {BUS IMMEDIATE}
--------	--

Query Syntax	TRIGger:TRANsient:SOURce?
--------------	---------------------------

Parameter/Return	BUS	Internal software trigger. Waits for the *TRG (or IEEE 488.1 “get” group execute trigger) command to start the trigger.
	IMMEDIATE	Starts the trigger immediately. (default)

Example	TRIG:TRAN:SOUR BUS Sets the trigger source as BUS.
---------	---

TRIGger:OUTPut[:IMMediate]

Set →

Description Generates a software trigger for the output trigger system. On a trigger, sets the output state. Refer to the :OUTP:TRIG command on page 62.

Syntax TRIGger:OUTPut[:IMMediate]

Related commands OUTPut[:STATe]:TRIGgered

TRIGger:OUTPut:SOURce

Set →

→ **Query**

Description Sets or queries the trigger source for the output system.

Syntax TRIGger:OUTPut:SOURce [BUS | IMMediate]

Query Syntax TRIGger:OUTPut:SOURce?

Parameter/Return	BUS	Internal software trigger. Waits for the *TRG (or IEEE 488.1 "get" group execute trigger) command to start the trigger.
	IMMediate	Starts the trigger immediately. (default)

Example TRIG:OUTP:SOUR BUS
Sets the trigger source of the output system as BUS.

Trigger Command Examples

1. The transient system for the trigger in immediate mode.

Example 1 TRIG:TRAN:SOUR IMM
CURR:TRIG MAX
VOLT:TRIG 5
INIT:NAME TRAN

≤=The current changes to the maximum, and the voltage changes to 5V.

System Function Command

SYSTem:BEEPer[:IMMediate]	80
SYSTem:CONFigure:BEEPer[:STATe]	80
SYSTem:CONFigure:BLEeder[:STATe]	81
SYSTem:CONFigure:BTrip[:IMMediate]	81
SYSTem:CONFigure:BTrip:PROTection	81
SYSTem:CONFigure:CURREnt:CONTRol	82
SYSTem:CONFigure:VOLTage:CONTRol	82
SYSTem:CONFigure:MSLave	83
SYSTem:CONFigure:OUTPut:EXTernal[:MODE]	83
SYSTem:CONFigure:OUTPut:PON[:STATe]	84
SYSTem:COMMunicate:ENABLE	84
SYSTem:COMMunicate:GPIB[:SELf]:ADDReSS	85
SYSTem:COMMunicate:LAN:IPADdress	85
SYSTem:COMMunicate:LAN:GATEway	85
SYSTem:COMMunicate:LAN:SMASk	86
SYSTem:COMMunicate:LAN:MAC	86
SYSTem:COMMunicate:LAN:DHCP	86
SYSTem:COMMunicate:LAN:DNS	87
SYSTem:COMMunicate:LAN:HOSTname	87
SYSTem:COMMunicate:LAN:WEB:PACTive	87
SYSTem:COMMunicate:LAN:WEB:PASSword	88
SYSTem:COMMunicate:RLState	88
SYSTem:COMMunicate:USB:FRONT:STATe	89
SYSTem:COMMunicate:USB:REAR:STATe	89
SYSTem:COMMunicate:USB:REAR:MODE	89
SYSTem:ERRor	89
SYSTem:KEYLock:MODE	90
SYSTem:KLOCK	90
SYSTem:INFormation	90
SYSTem:PRESet	91
SYSTem:VERSion	91

Set →

→ Query

SYSTem:BEEPer[:IMMediate]

Description	This command causes an audible tone to be generated by the instrument. The duration time is specified in seconds.	
Syntax	SYSTem:BEEPer[:IMMediate] {<NR1> MINimum MAXimum}	
Query Syntax	SYSTem:BEEPer[:IMMediate]? [MINimum MAXimum]	
Parameter	<NR1>	0 ~ 3600 seconds.
	MINimum	Sets the beeper time to the minimum (0 seconds)
	MAXimum	Sets the beeper time to the maximum (3600 seconds)
Return parameter	<NR1>	Returns the remaining beeper duration time in seconds or returns the maximum or minimum beeper time in seconds (for the [MINimum MAXimum] query parameters).

Example 1

```
SYST:BEEP 10
**after a 2 second wait**
SYST:BEEP?
>8
```

The first command turns the beeper on for 10 seconds. After 2 seconds the SYST:BEEP? query returns the remaining beeper time (8 seconds).

Example 2

```
SYST:BEEP? MAX
>3600
```

Returns the maximum settable beeper time in seconds.

Set →

→ Query

SYSTem:CONFigure:BEEPer[:STATe]

Description	Sets or queries the buzzer state on/off.	
Syntax	SYSTem:CONFigure:BEEPer[:STATe] {OFF ON 0 1}	
Query Syntax	SYSTem:CONFigure:BEEPer[:STATe]?	

Parameter	0	<NR1> Turns the buzzer off.
	OFF	Turns the buzzer off.
	1	<NR1> Turns the buzzer on.
	ON	Turns the buzzer on.

Return parameter <Boolean> Returns the buzzer status.

Set →

SYSTEM:CONFigure:BLEeder[:STATe]

→ Query

Description Sets or queries the status of the bleeder resistor.

Syntax SYSTEM:CONFigure:BLEeder[:STATe]

Query Syntax {OFF|ON|AUTO|0|1|2}

SYSTEM:CONFigure:BLEeder[:STATe]?

Parameter	0	<NR1> Turns the bleeder resistor off.
	OFF	Turns the bleeder resistor off.
	1	<NR1> Turns the bleeder resistor on.
	ON	Turns the bleeder resistor on.
	2	<NR1> Turns the AUTO mode on.
	AUTO	Turns the AUTO mode on.

Return parameter <NR1> Returns bleeder resistor status.

SYSTEM:CONFigure:BTrip[:IMMediate]

Set →

Description Trips the power switch trip (circuit breaker) to turn the unit off (shut down the power).

Syntax SYSTEM:CONFigure:BTrip[:IMMediate]

Set →

SYSTEM:CONFigure:BTrip:PROTection

→ Query

Description Enables/Disables the power switch trip (circuit breaker) when the OVP or OCP protection settings are tripped. This setting only applies after power has been reset.

Syntax SYSTEM:CONFigure:BTrip:PROTection {OFF|ON|0|1}

Query Syntax SYSTEM:CONFigure:BTrip:PROTection?

Parameter	0	<NR1> Disables the power switch trip for OVP or OCP.
	OFF	Disables the power switch trip for OVP or OCP.
	1	<NR1> Enables the power switch trip for OVP or OCP.
	ON	Enables the power switch trip for OVP or OCP.

Return parameter <Boolean> Returns power switch trip setting.

Set →

SYSTEM:CONFigure:CURRENT:CONTROL

→ Query

Description Sets or queries the CC control mode (local control (panel), external voltage control, external resistance control). This setting is applied only after the unit is reset.

Syntax SYSTEM:CONFigure:CURRENT:CONTROL { 0 | 1 | 2 | 3 }

Query Syntax SYSTEM:CONFigure:CURRENT:CONTROL?

Parameter/Return	<NR1>	Description
	0	Local (Panel) control
	1	External voltage control
	2	External resistance control; 10kΩ = Io max, 0kΩ = Io min.
	3	External resistance control; 10kΩ = Io min, 0kΩ = Io max.

Set →

SYSTEM:CONFigure:VOLTage:CONTROL

→ Query

Description Sets or queries the CV control mode (local control, external voltage control, external resistance control). This setting is applied only after the unit is reset.

Syntax SYSTEM:CONFigure:VOLTage:CONTROL { 0 | 1 | 2 | 3 }

Query Syntax SYSTEM:CONFigure:VOLTage:CONTROL?

Parameter/Return	<NR1>	Description
	0	Local (Panel) control
	1	External voltage control

2	External resistance control; 10kΩ = Vo max, 0kΩ = Vo min.
3	External resistance control; 10kΩ = Vo min, 0kΩ = Vo max.

Set →

→ Query

SYSTEM:CONFigure:MSLave

Description	Sets or queries the unit operation mode. This setting is only applied after the unit has been reset.
Syntax	SYSTEM:CONFigure:MSLave { 0 1 2 3 4 }
Query Syntax	SYSTEM:CONFigure:MSLave?
Note	Series mode is only supported for 30V, 80V and 160V models.

Parameter/Return	<NR1>	Description
	0	Master/Local
	1	Master/Parallel 1 (2 units)
	2	Master/Parallel 2 (3 units)
	3	Slave/Parallel
	4	Slave/Series

SYSTEM:CONFigure:OUTPut:EXTErnal[:MODE]

Set →

→ Query

Description	Sets the external logic as active high or active low. This setting is only applied after the unit has been reset.
Syntax	SYSTEM:CONFigure:OUTPut:EXTErnal[:MODE]
Query Syntax	SYSTEM:CONFigure:OUTPut:EXTErnal[:MODE]?
Parameter	0 Active high HIGH Active high 1 Active low LOW Active low
Return Parameter	0 <boolean>Active high 1 <boolean>Active low

SYSTEM:CONFigure:OUTPut:PON[:STATe] (Set) →
→ (Query)

Description	Sets the unit to turn the output ON/OFF at power-up. This setting is only applied after the unit has been reset.	
Syntax	SYSTEM:CONFigure:OUTPut:PON[:STATe] {OFF ON 0 1}	
Query Syntax	SYSTEM:CONFigure:OUTPut:PON[:STATe]?	
Parameter	0 OFF 1 ON	Output off at power up Output off at power up Output on at power up Output on at power up
Return Parameter	0 1	Output off at power up Output on at power up

SYSTEM:COMMunicate:ENABLE (Set) →
→ (Query)

Description	Enables/Disables LAN, GPIB or USB remote interfaces as well as remote services (Sockets, Web Server). This setting is applied only after the unit is reset.	
Syntax	SYSTEM:COMMunicate:ENABLE <mode>,<interface>	
Query Syntax	SYSTEM:COMMunicate:ENABLE? <interface>	
Parameter	<mode> OFF 0 ON 1	Turns the selected mode off. Turns the selected mode off. Turns the selected mode on. Turns the selected mode on.
	<interface> GPIB USB LAN SOCKets WEB	Select GPIB Select USB Select LAN Select Sockets Select the web server
Return Parameter	0 1	The selected mode is off. The selected mode is on.

Example	SYST:COMM:ENAB 1,USB Turns the USB interface on.
Query Example	SYST:COMM:ENAB? USB 1 Queries the USB state, returns 1 (USB is on).

SYSTem:COMMunicate:GPIB[:SELf]:ADDR Set →
 ess → Query

Description	Sets or queries the GPIB address. This setting is applied only after the unit is reset.
Syntax	SYSTem:COMMunicate:GPIB[:SELf]:ADDRess <NR1>
Query Syntax	SYSTem:COMMunicate:GPIB[:SELf]:ADDRess?
Parameter/Return	<NR1> 0~30
Example	SYST:COMM:GPIB:SELf:ADDR 15 Sets the GPIB address to 15.

SYSTem:COMMunicate:LAN:IPAddress Set →
→ Query

Description	Sets or queries LAN IP address. This setting is applied only after the unit is reset.
Syntax	SYSTem:COMMunicate:LAN:IPAddress <string>
Query Syntax	SYSTem:COMMunicate:LAN:IPAddress?
Parameter/Return	<string> LAN IP address in string format ("address") Applicable ASCII characters: 20H to 7EH
Example	SYST:COMM:LAN:IPAD "172.16.5.111" Sets the IP address to 172.16.5.111.

SYSTem:COMMunicate:LAN:GATEway Set →
→ Query

Description	Sets or queries the Gateway address. This setting is applied only after the unit is reset.
-------------	--

Syntax	SYSTem:COMMunicate:LAN:GATEway <string>
Query Syntax	SYSTem:COMMunicate:LAN:GATEway?
Parameter/Return	<string> Gateway address in string format (“address”) Applicable ASCII characters: 20H to 7EH
Example	SYST:COMM:LAN:GATE “172.16.0.254” Sets the LAN gateway to 172.16.0.254.

Set →

SYSTem:COMMunicate:LAN:SMASK

→ Query

Description Sets or queries the LAN subnet mask. This setting is applied only after the unit is reset.

Syntax SYSTem:COMMunicate:LAN:SMASK <string>

Query Syntax SYSTem:COMMunicate:LAN:SMASK?

Parameter/Return <string> Subnet mask in string format (“mask”)
 Applicable ASCII characters: 20H to 7EH

Example SYST:COMM:LAN:SMASK “255.255.0.0”
 Sets the LAN mask to 255.255.0.0.

SYSTem:COMMunicate:LAN:MAC

→ Query

Description Returns the unit MAC address as a string. The MAC address cannot be changed.

Query Syntax SYSTem:COMMunicate:LAN:MAC?

Return parameter <string> Returns the MAC address in the following format “FF-FF-FF-FF-FF-FF”

Example SYST:COMM:LAN:MAC?
 02-80-AD-20-31-B1
 Returns the MAC address.

Set →

SYSTem:COMMunicate:LAN:DHCP

→ Query

Description Turns DHCP on/off. Queries the DHCP status. This setting is applied only after the unit is reset.

Syntax SYSTem:COMMunicate:LAN:DHCP {OFF | ON | 0 | 1}

Query Syntax SYSTem:COMMunicate:LAN:DHCP?

Parameter 0 DHCP off

	OFF	DHCP off
	1	DHCP on
	ON	DHCP on
Return parameter	0	<boolean>DHCP off
	1	<boolean>DHCP on

Set →

SYSTEM:COMMunicate:LAN:DNS

→ Query

Description	Sets or queries the DNS address. This setting is applied only after the unit is reset.
Syntax	SYSTEM:COMMunicate:LAN:DNS <string>
Query Syntax	SYSTEM:COMMunicate:LAN:DNS?
Parameter/Return	<string> DNS in string format ("mask") Applicable ASCII characters: 20H to 7EH
Example	SYST:COMM:LAN:DNS "172.16.1.252" Sets the DNS to 172.16.1.252.

SYSTEM:COMMunicate:LAN:HOSTname

→ Query

Description	Queries the host name.
Query Syntax	SYSTEM:COMMunicate:LAN:HOSTname?
Return Parameter	<string> Host name in string format
Query Example	SYST:COMM:LAN:HOST? P-160054 Returns the host name (P-160054).

Set →

SYSTEM:COMMunicate:LAN:WEB:PACTIVE

→ Query

Description	Sets or queries whether the web password is on or off. This setting is applied only after the unit is reset.
Syntax	SYSTEM:COMMunicate:LAN:WEB:PACTIVE {OFF ON 0 1}
Query Syntax	SYSTEM:COMMunicate:LAN:WEB:PACTIVE?
Parameter	0 Web password off OFF Web password off

	1	Web password on
	ON	Web password on
Return parameter	0	<boolean> Web password off
	1	<boolean> Web password on

Set →

SYSTem:COMMunicate:LAN:WEB:PASSword → Query

Description	Sets or queries the web password. This setting is applied only after the unit is reset.	
Syntax	SYSTem:COMMunicate:LAN:WEB:PASSword <NR1>	
Query Syntax	SYSTem:COMMunicate:LAN:WEB:PASSword?	
Parameter/Return	<NR1>	0 ~ 9999
Example	SYST:COMM:LAN:WEB:PASS 1234	
	Set the web password as 1234.	

Set →

SYSTem:COMMunicate:RLState → Query

Description	Sets or queries the control state of the instrument.	
Note	Only applicable for software version 1.60 or above.	
Syntax	SYSTem:COMMunicate:RLState {LOCAL REMote RWLock}	
Query Syntax	SYSTem:COMMunicate:RLState ?	
Parameter	LOCAL	Sets the instrument to front panel control.
	REMote	Sets the instrument to remote interface control.
	RWLock	Disables the front panel keys and only allows the instrument to be controlled via the remote interface.
Return parameter	LOC	The instrument is set to front panel control.
	REM	The instrument is set to remote interface control.
	RWL	The front panel keys are disabled. The instrument can only be controlled via the remote interface.
Example	SYST:COMM:RLST: LOC	
	Sets the instrument to front panel control.	

SYSTem:COMMunicate:USB:FRONT:STATe → **Query**

Description	Queries the front panel USB-A port state.	
Query Syntax	SYSTem:COMMunicate:USB:FRONT:STATe?	
Return parameter	0	<NR1>Absent
	1	<NR1>Mass Storage

SYSTem:COMMunicate:USB:REAR:STATe → **Query**

Description	Queries the rear panel USB-B port state.	
Query Syntax	SYSTem:COMMunicate:USB:REAR:STATe?	
Return parameter	0	<NR1>Absent
	1	<NR1>USB-CDC
	2	<NR1>GPIB-USB (GUG-001)

Set →

SYSTem:COMMunicate:USB:REAR:MODE → **Query**

Description	Sets or queries the rear panel USB-B port mode. This command is the equivalent to the F-22 configuration setting.	
Syntax	SYSTem:COMMunicate:USB:REAR:MODE {0 1 2 3}	
Query Syntax	SYSTem:COMMunicate:USB:REAR:MODE?	
Parameter/	0	Disable
Return parameter	1	GPIB-USB adapter
	2	Auto detect speed
	3	Full speed only
Example	SYST:COMM:USB:REAR:MODE 1 Sets the rear panel USB-B port mode to GPIB-USB adapter.	

SYSTem:ERRor → **Query**

Description	Queries the error queue. The last error message is returned. A maximum of 32 errors are stored in the error queue.
-------------	--

Query Syntax	SYSTem:ERRor?	
Parameter/Return	<NR1>,<string>	Returns an error code followed by an error message as a string. The string is returned as "string".
Example	SYSTem:ERRor? -100, "Command error"	

Set →

→ Query

SYSTem:KEYLock:MODE

Description	Sets or queries the key lock mode. This setting is the equivalent of the F-19 function setting.	
Syntax	SYSTem:KEYLock:MODE {0 1}	
Query Syntax	SYSTem:KEYLock:MODE?	
Parameter / Return parameter	0	Panel lock: allow output off.
	1	Panel lock: allow output on/off.

Set →

→ Query

SYSTem:KLOCK

Description	Enables or disables the front panel key lock.	
Syntax	SYSTem:KLOCK { OFF ON 0 1}	
Query Syntax	SYSTem:KLOCK?	
Parameter	0	Panel keys unlocked
	OFF	Panel keys unlocked
	1	Panel keys locked
	ON	Panel keys locked
Return parameter	0	<boolean>Panel keys unlocked
	1	<Boolean>Panel keys locked

→ Query

SYSTem:INFormation

Description	Queries the system information. Returns the machine version, build date, keyboard CPLD version and analog CPLD version.	
Query Syntax	SYSTem:INFormation?	
Return Parameter	<block data>	Definite length arbitrary block response data.

Query Example SYST:INF?

#3212MFRS GW-INSTEK,Model PSW80-13.5,SN
 TW0123456789,Firmware-Version 01.43.20130424,
 Keyboard-CPLD 0x30c,AnalogControl-CPLD
 0x421,Kernel-BuiltON 2013-3-22,TEST-Version
 01.00,TEST-BuiltON 2011-8-1,MAC 02-80-ad-20-31-b1

Returns the system information as a block data.

SYSTEM:PRESet Set →

Description Resets all the settings to the factory default settings. See page 115 for details.

Syntax SYSTEM:PRESet

SYSTEM:VERSion → Query

Description Returns the version of the SCPI specifications that the unit complies with.

Query Syntax SYSTem:VERSion?

Return <1999.0> Always returns the SCPI version: 1999.0.

IEEE 488.2 Common Commands

*CLS	92
*ESE	92
*ESR	92
*IDN	92
*OPC	93
*RST	93
*SRE	93
*STB	94
*TRG	94
*TST	94
*WAI	94

***CLS**

Set →

Description The *CLS command clears the Standard Event Status, Operation Status and Questionable Status registers. The corresponding Enable registers in each of the above registers are not cleared.

If a <NL> newline code immediately precedes a *CLS command, the Error Que and the MAV bit in the Status Byte Register is also cleared.

Syntax *CLS

***ESE**

Set →

→ Query

Description Sets or queries the Standard Event Status Enable register.

Syntax *ESE <NR1>

Query Syntax *ESE?

Parameter <NR1> 0~255

Return parameter <NR1> Returns the bit sum of the Standard Event Status Enable register.

***ESR**

→ Query

Description Queries the Standard Event Status (Event) register. The Event Status register is cleared after it is read.

Query Syntax *ESR?

Return parameter <NR1> Returns the bit sum of the Standard Event Status (Event) register and clears the register.

***IDN**

→ Query

Description Queries the manufacturer, model name, serial number, and firmware version of the PSW.

Query Syntax *IDN?

Return parameter <string> Returns the instrument identification as a string in the following format:
 GW-INSTEK,PSW-3036,TW123456,01.00.20110101
 Manufacturer: GW-INSTEK
 Model number : PSW-3036
 Serial number : TW123456
 Firmware version : 01.00.20110101

Set →

***OPC**

→ Query

Description The *OPC command sets the OPC bit (bit0) of the Standard Event Status Register when all current commands have been processed.
 The *OPC? Query returns 1 when all the outstanding commands have completed.

Syntax *OPC

Query Syntax *OPC?

Return parameter 1 Returns 1 when all the outstanding commands have completed.

***RST**

Set →

Description Performs a device reset. Configures the unit to a known configuration (default settings). This known configuration is independent of the usage history.

Syntax *RST

Set →

***SRE**

→ Query

Description Sets or queries the Service Request Enable register. The Service Request Enable register determines which registers of the Status Byte register are able to generate service requests.

Syntax *SRE <NR1>

Query Syntax *SRE?

Parameter	<NR1>	0~255
Return parameter	<NR1>	Returns the bit sum of the Service Request Enable register.

***STB**

→ Query

Description	Queries the bit sum of the Status Byte register with MSS (Master summary Status).	
Query Syntax	*STB?	
Return parameter	<NR1>	Returns the bit sum of the Status Byte register with the MSS bit (bit 6).

***TRG**

Set →

Description	The *TRG command is able to generate a “get” (Group Execute Trigger). If the PSW cannot accept a trigger at the time of the command, an error message is generated (-211, “Trigger ignored”).	
Syntax	*TRG	

***TST**

→ Query

Description	Executes a self test.	
Query Syntax	*TST?	
Return parameter	0	Returns “0” if there are no errors.
	<NR1>	Returns an error code <NR1> if there is an error.

***WAI**

Set →

Description	Prevents any other commands or queries from being executed until all outstanding commands have completed.	
Syntax	*WAI	

Status Register Overview

To program the PSW power supply effectively, the Status registers need to be understood. This chapter explains in detail how the Status registers are used and how to configure them.

Introduction to the Status Registers.....	95
The Status Registers	96
Questionable Status Register Group.....	97
Operation Status Register Group	99
Standard Event Status Register Group	102
Status Byte Register & Service Request Enable Register	104

Introduction to the Status Registers

Overview

The status registers are used to determine the status of the power supply. The status registers maintain the status of the protection conditions, operation conditions and instrument errors.

The PSW Series have a number of register groups:

- Questionable Status Register Group
- Standard Event Status Register Group
- Operation Status Register Group
- Status Byte Register
- Service Request Enable Register
- Service Request Generation
- Error Queue
- Output Buffer

The next page shows the structure of the Status registers.

The Status Registers

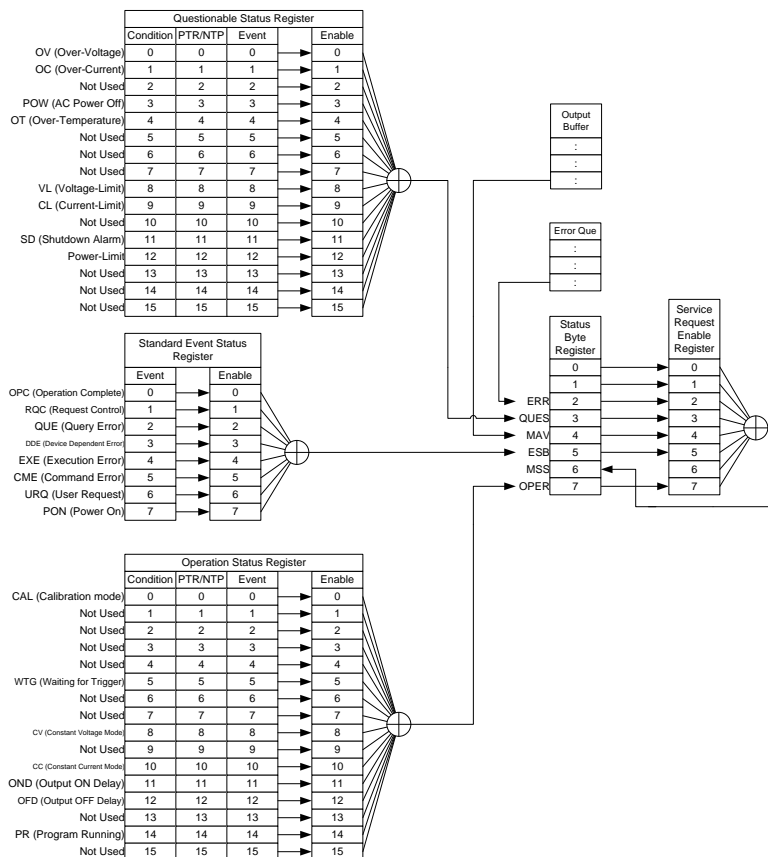

Questionable Status Register Group

Overview

The Questionable Status Register Group indicates if any protection modes or limits have been tripped.

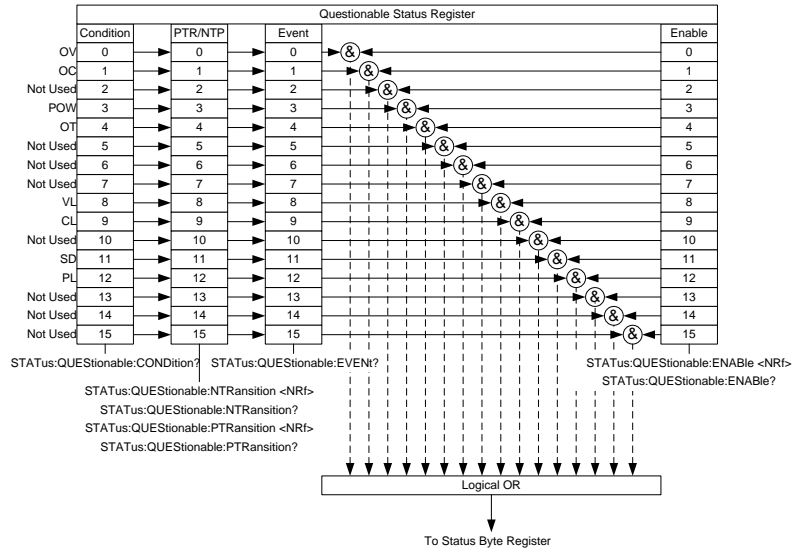

Bit Summary

Event	Bit #	Bit Weight
OV (Over-Voltage) Over voltage protection has been tripped	0	1
OC (Over-Current) Over current protection has been tripped	1	2
POW (AC Power Off) AC power switch is off	3	8

OT (Over Temperature)	4	16
Over temperature protection has been tripped		
VL (Voltage Limit)	8	256
Voltage limit has been reached		
CL (Current Limit)	9	512
Current limit has been reached		
SD (Shutdown Alarm)	11	2048
PL (Power-Limit)	12	4096

Condition Register The Questionable Status Condition Register indicates the status of the power supply. If a bit is set in the Condition register, it indicates that the event is true. Reading the condition register does not change the state of the condition register.

PTR/NTR Filters The PTR/NTR (Positive/Negative transition) register determines the type of transition conditions that will set the corresponding bit in the Event Registers. Use the Positive transition filter to view events that change from false to positive, and use the negative transition filter to view events that change from positive to negative.

Positive Transition	0→1
Negative Transition	1→0

Event Register The PTR/NTR Register will dictate the type of transition conditions will set the corresponding bits in the Event Register. If the Event Register is read, it will be cleared to 0.

Enable Register The Enable register determines which Events in the Event Register will be used to set the QUES bit in the Status Byte Register.

Operation Status Register Group

Overview

The Operation Status Register Group indicates the operating status of the power supply.

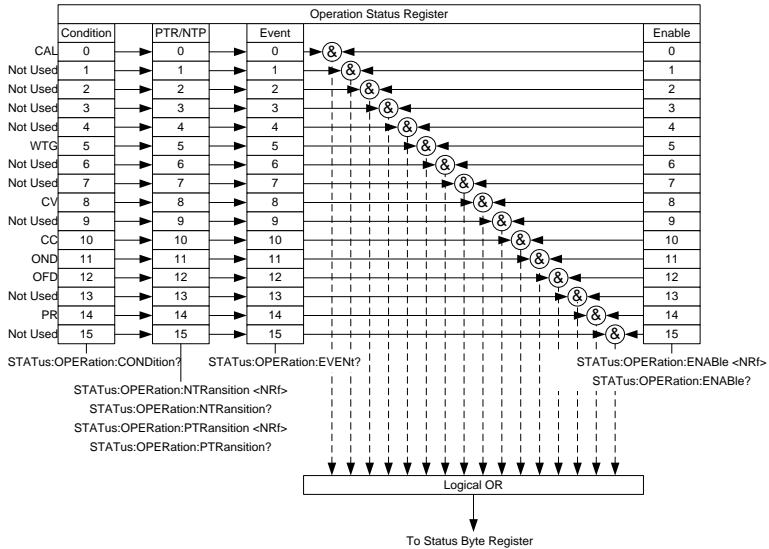

Bit Summary

Event	Bit #	Bit Weight
CAL (Calibration mode)	0	1
Indicates if the PSW is in calibration mode.		
WTG (Waiting for trigger)	5	32
Indicates if the PSW is waiting for a trigger.		
CV (Constant voltage mode)	8	256
Indicates if the PSW is in CV mode.		

CC (Constant current mode)	10	1024
Indicates if the PSW is in CC mode.		
OND (Output ON Delay)	11	2048
Indicates if Output ON delay time is active		
OFD (Output OFF Delay)	12	4096
Indicates if Output OFF delay time is active		
PR (Program Running)	13	8192
Indicates if a Test is running		

Condition Register The Operation Status Condition Register indicates the operating status of the power supply. If a bit is set in the Condition register, it indicates that the event is true. Reading the condition register does not change the state of the condition register.

PTR/NTR Filters The PTR/NTR (Positive/Negative transition) register determines the type of transition conditions that will set the corresponding bit in the Event Registers. Use the Positive transition filter to view events that change from false to positive, and use the negative transition filter to view events that change from positive to negative.

Positive Transition	0→1
Negative Transition	1→0

Event Register The PTR/NTR Register will dictate the type of transition conditions will set the corresponding bits in the Event Register. If the Event Register is read, it will be cleared to 0.

Enable Register

The Enable register determines which registered Events in the Event Register will be used to set the OPER bit in the Status Byte Register.

Standard Event Status Register Group

Overview

The Standard Event Status Register Group indicates if any errors have occurred. The bits of the Event register are set by the error event queue.

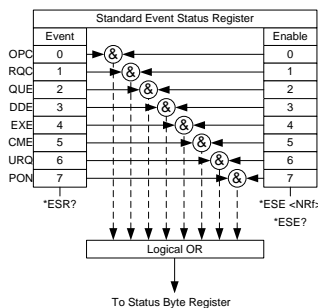

Bit Summary

Event	Bit #	Bit Weight
OPC (Operation complete)	0	1
The OCP bit is set when all selected pending operations are complete. This bit is set in response to the *OPC command.		
RQC (Request control)	1	2
QUE (Query Error)	2	4
The Query Error bit is set in response to an error reading the Output Queue. This can be caused by trying to read the Output Queue when there is no data present.		
DDE (Device Dependent Error)	3	8
Device specific error.		

	EXE (Execution Error)	4	16
	The EXE bit indicates an execution error due to one of the following: illegal command parameter, parameter out of range, invalid parameter, the command didn't execute due to an overriding operation condition.		
	CME (Command Error)	5	32
	The CME bit is set when a syntax error has occurred. The CME bit can also be set when a <GET> command is received within a program message.		
	URQ (User Request)	6	64
	PON (Power On)	7	128
	Indicates the power is turned on.		
Event Register	Any bits set in the event register indicate that an error has occurred. Reading the Event register will reset the register to 0.		
Enable Register	The Enable register determines which Events in the Event Register will be used to set the ESB bit in the Status Byte Register.		

Status Byte Register & Service Request Enable Register

Overview

The Status Byte register consolidates the status events of all the status registers. The Status Byte register can be read with the *STB? query and can be cleared with the *CLS command.

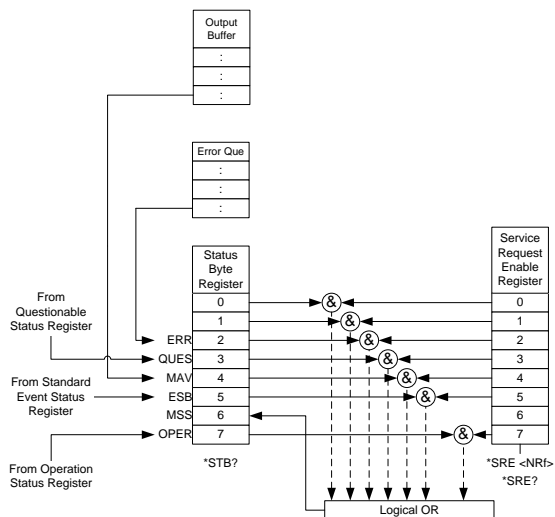

Bit Summary

Event	Bit #	Bit Weight
ERR (Error Event/Queue) If data is present in the Error queue, the ERR bit will be set.	2	4
QUES (Questionable Status Register) The summary bit for the Questionable Status Register group.	3	8
MAV (Message Available) This is set when there is data in the Output Queue waiting to be read.	4	16

	(ESB) Event Summary Bit. The ESB is the summary bit for the Standard Event Status Register group.	5	32
	MSS Bit The MSS Bit is the summary of the Status Byte Register and Service Request register (bits 1-5, 7). This will be set to 1.	6	64
	OPER (Operation Status Register) Group. OPER bit is the summary bit for the Operation Status Register Group.	7	128
Status Byte Register	Any bits set in the Status byte register acts as a summary register for all the three other status registers and indicates if there is a service request, an error in the Error Queue or data in the Output Queue. Reading the Status Byte register will reset the register to 0.		
Service Request Enable Register	The Service Request Enable Register controls which bits in the Status Byte Register are able to generate service requests.		

Error List

Command Errors.....	106
Execution Errors	110
Device Specific Errors	112
Query Errors	113

Command Errors

Overview

An <error/event number> in the range [-199 , -100] indicates that an IEEE 488.2 syntax error has been detected by the instrument's parser. The occurrence of any error in this class shall cause the command error bit (bit 5) in the event status register (IEEE 488.2, section 11.5.1) to be set. One of the following events has occurred:

- An IEEE 488.2 syntax error has been detected by the parser. That is, a controller-to-device message was received which is in violation of the IEEE 488.2 standard. Possible violations include a data element which violates the device listening formats or whose type is unacceptable to the device.
- An unrecognized header was received. Unrecognized headers include incorrect device-specific headers and incorrect or unimplemented IEEE 488.2 common commands.

Events that generate command errors shall not generate execution errors, device-specific errors, or query errors; see the other error definitions in this chapter.

Error Code	Description
-100 Command Error	This is the generic syntax error for devices that cannot detect more specific errors. This code indicates only that a Command Error as defined in IEEE 488.2,11.5.1.1.4 has occurred.
-102 Syntax error	An unrecognized command or data type was encountered; for example, a string was received when the device does not accept strings.
-103 Invalid separator	The parser was expecting a separator and encountered an illegal character; for example, the semicolon was omitted after a program message unit, MEAS:VOLT:DC?:MEASCURR:DC?
-104 Data type error	The parser recognized a data element different than one allowed; for example, numeric or string data was expected but block data was encountered.
-108 Parameter not allowed	More parameters were received than expected for the header; for example, the KLOCK command only accepts one parameter, so receiving SYSTem:KLOCK 1,0 is not allowed.
-109 Missing parameter	Fewer parameters were received than required for the header; for example, the KLOCK command requires one parameter, so receiving KLOCK is not allowed.
-111 Header separator error	A character which is not a legal header separator was encountered while parsing the header; for example, no white space followed the header, thus APPL5,1 is an error.

-112 Program mnemonic too long	The header contains more than twelve characters (see IEEE 488.2, 7.6.1.4.1).
-113 Undefined header	The header is syntactically correct, but it is undefined for this specific device; for example, *XYZ is not defined for any device.
-114 Header suffix out of range	The value of a numeric suffix attached to a program mnemonic, see Syntax and Style section 6.2.5.2, makes the header invalid.
-115 Unexpected number of parameters	The number of parameters received does not correspond to the number of parameters expected. This is typically due to an inconsistency with the number of instruments in the selected group.
-120 Numeric data error	This error, as well as errors -121 through -129, are generated when parsing a data element which appears to be numeric, including the nondecimal numeric types. This particular error message should be used if the device cannot detect a more specific error.
-121 Invalid character in number	An invalid character for the data type being parsed was encountered; for example, an alpha in a decimal numeric or a "9" in octal data.
-128 Numeric data not allowed	A legal numeric data element was received, but the device does not accept one in this position for the header.
-131 Invalid suffix	The suffix does not follow the syntax described in IEEE 488.2, 7.7.3.2, or the suffix is inappropriate for this device.

-141 Invalid character data	Either the character data element contains an invalid character or the particular element received is not valid for the header.
-148 Character data not allowed	A legal character data element was encountered where prohibited by the device.
-151 Invalid string data	A string data element was expected, but was invalid for some reason (see IEEE 488.2, 7.7.5.2); for example, an END message was received before the terminal quote character.
-158 String data not allowed	A string data element was encountered but was not allowed by the device at this point in parsing.
-160 Block data error	This error, as well as errors -161 through -169, are generated when parsing a block data element. This particular error message should be used if the device cannot detect a more specific error.
-161 Invalid block data	A block data element was expected, but was invalid for some reason (see IEEE 488.2, 7.7.6.2); for example, an END message was received before the length was satisfied.
-168 Block data not allowed	A legal block data element was encountered but was not allowed by the device at this point in parsing.
-178 Expression data not allowed	A legal expression data was encountered but was not allowed by the device at this point in parsing.

Execution Errors

Overview An <error/event number> in the range [-299 , -200] indicates that an error has been detected by the instrument’s execution control block. The occurrence of any error in this class shall cause the execution error bit (bit 4) in the event status register (IEEE 488.2, section 11.5.1) to be set. One of the following events has occurred:

- A <PROGRAM DATA> element following a header was evaluated by the device as outside of its legal input range or is otherwise inconsistent with the device’s capabilities.
- A valid program message could not be properly executed due to some device condition.

Execution errors shall be reported by the device after rounding and expression evaluation operations have taken place. Rounding a numeric data element, for example, shall not be reported as an execution error. Events that generate execution errors shall not generate Command Errors, device-specific errors, or Query Errors; see the other error definitions in this section.

Error Code	Description
-200 Execution error	This is the generic syntax error for devices that cannot detect more specific errors. This code indicates only that an Execution Error as defined in IEEE 488.2, 11.5.1.1.5 has occurred.

-201 Invalid while in local	Indicates that a command is not executable while the device is in local due to a hard local control (see IEEE 488.2, 5.6.1.5); for example, a device with a rotary switch receives a message which would change the switches state, but the device is in local so the message can not be executed.
-203 Command protected	Indicates that a legal password-protected program command or query could not be executed because the command was disabled.
-211 Trigger ignored	Indicates that a GET, *TRG, or triggering signal was received and recognized by the device but was ignored because of device timing considerations; for example, the device was not ready to respond. Note: a DT0 device always ignores GET and treats *TRG as a Command Error.
-213 Init ignored	Indicates that a request for a measurement initiation was ignored as another measurement was already in progress.
-220 Parameter error	Indicates that a program data element related error occurred. This error message should be used when the device cannot detect the more specific errors described for errors -221 through -229.
-221 Settings conflict	Indicates that a legal program data element was parsed but could not be executed due to the current device state (see IEEE 488.2, 6.4.5.3 and 11.5.1.1.5.).

-222 Data out of range	Indicates that a legal program data element was parsed but could not be executed because the interpreted value was outside the legal range as defined by the device (see IEEE 488.2, 11.5.1.1.5.).
-224 Illegal parameter value	Used where exact value, from a list of possibles, was expected.

Device Specific Errors

Overview An <error/event number> in the range [-399 , -300] or [1 , 32767] indicates that the instrument has detected an error which is not a command error, a query error, or an execution error; some device operations did not properly complete, possibly due to an abnormal hardware or firmware condition. These codes are also used for self-test response errors. The occurrence of any error in this class should cause the device-specific error bit (bit 3) in the event status register (IEEE 488.2, section 11.5.1) to be set. The meaning of positive error codes is device-dependent and may be enumerated or bit mapped; the <error message>string for positive error codes is not defined by SCPI and available to the device designer.

Note that the string is not optional; if the designer does not wish to implement a string for a particular error, the null string should be sent (for example, 42,""). The occurrence of any error in this class should cause the device-specific error bit (bit 3) in the event status register (IEEE 488.2, section 11.5.1) to be set. Events that generate device-specific errors shall not generate command errors, execution errors,

or query errors; see the other error definitions in this section.

Error Code	Description
-310 System error	Indicates that some error, termed “system error” by the device, has occurred. This code is device-dependent.
-320 Storage fault	Indicates that the firmware detected a fault when using data storage. This error is not an indication of physical damage or failure of any mass storage element.

Query Errors

Overview

An <error/event number> in the range [-499 , -400] indicates that the output queue control of the instrument has detected a problem with the message exchange protocol described in IEEE 488.2, chapter 6. The occurrence of any error in this class shall cause the query error bit (bit 2) in the event status register (IEEE 488.2, section 11.5.1) to be set. These errors correspond to message exchange protocol errors described in IEEE 488.2, section 6.5. One of the following is true:

- An attempt is being made to read data from the output queue when no output is either present or pending;
- Data in the output queue has been lost.

Events that generate query errors shall not generate command errors, execution errors, or device-specific errors; see the other error definitions in this section.

Error Code	Description
-400 Query error	This is the generic query error for devices that cannot detect more specific errors. This code indicates only that a Query Error as defined in IEEE 488.2, 11.5.1.1.7 and 6.3 has occurred.

APPENDIX

PSW Default Settings

The following default settings are the factory configuration settings for the power supply (Function settings/Test settings).

Initial Settings		
Initial Settings	Default Setting	
Output	Off	
LOCK	0 (Disabled)	
Voltage	0V	
Current	0A	
OVP	Maximum	
OCP	Maximum	
Normal Function Settings		
Settings	Setting	Default Setting
Output ON delay time	F-01	0.00s
Output OFF delay time	F-02	0.00s
V-I mode slew rate select	F-03	0 = CV high speed priority
Rising voltage slew rate	F-04	60.00V/s (PSW 30-XX)
		160.0V/s (PSW 80-XX)
		320.0V/s (PSW 160-XX)
		500.0V/s (PSW 250-XX)
		1600V/s (PSW 800-XX)
Falling voltage slew rate	F-05	60.00V/s (PSW 30-XX)
		160.0V/s (PSW 80-XX)
		320.0V/s (PSW 160-XX)
		500.0V/s (PSW 250-XX)
		1600V/s (PSW 800-XX)

Rising current slew rate	F-06	72.00A/s (PSW 30-36)
		144.0A/s (PSW 30-72)
		216.0A/s (PSW 30-108)
		27.00A/s (PSW 80-13.5)
		54.00A/s (PSW 80-27)
		81.00A/s (PSW 80-40.5)
		14.40A/s (PSW 160-7.2)
		28.80A/s (PSW 160-14.4)
		43.20A/s (PSW 160-21.6)
		9.000A/s (PSW 250-4.5)
		18.00A/s (PSW 250-9)
		27.00A/s (PSW 250-13.5)
		2.880A/s (PSW 800-1.44)
		5.760A/s (PSW 800-2.88)
8.640A/s (PSW 800-4.32)		
Falling current slew rate	F-07	72.00A/s (PSW 30-36)
		144.0A/s (PSW 30-72)
		216.0A/s (PSW 30-108)
		27.00A/s (PSW 80-13.5)
		54.00A/s (PSW 80-27)
		81.00A/s (PSW 80-40.5)
		14.40A/s (PSW 160-7.2)
		28.80A/s (PSW 160-14.4)
		43.20A/s (PSW 160-21.6)
		9.000A/s (PSW 250-4.5)
		18.00A/s (PSW 250-9)
		27.00A/s (PSW 250-13.5)
		2.880A/s (PSW 800-1.44)
		5.760A/s (PSW 800-2.88)
8.640A/s (PSW 800-4.32)		
Internal resistance setting	F-08	0.000Ω
Bleeder circuit control	F-09	1 = ON
Buzzer ON/OFF control	F-10	1 = ON
Measurement Average Setting	F-17	0 = Low
Lock Mode	F-19	0 = Panel lock: allow output off
USB/GPIB setting		
Rear Panel USB Mode	F-22	2 = USB CDC
GPIB address	F-23	8

LAN setting		
LAN	F-36	1 = Enable
DHCP	F-37	1 = Enable
Sockets active	F-57	1 = Enable
Web Server active	F-59	1 = Enable
Web password active	F-60	1 = Enable
Web setting password	F-61	0000

Power On Configuration		
CV Control	F-90	0= Panel control (local)
CC Control	F-91	0= Panel control (local)
Power-ON Output	F-92	0 = OFF at startup
Master/Slave	F-93	0 = Master/Local
External Out Logic	F-94	0= High ON
Power Switch trip	F-95	0 = Enable

Error Messages & Messages

The following error messages or messages may appear on the PSW screen during operation.

Error Messages	Description
Err 001	USB Mass Storage is not present
Err 002	No (such)file in USB mass storage
Err 003	Empty memory location
Err 004	File access error
Err 901	Keyboard CPLD error
Err 902	Analog CPLD error
Err 920	The ADC is over range for calibration
Err 921	The DAC is over range for calibration
Err 922	Point invalid for calibration

Messages	Description
MSG 001	External control of output. Output off (F-94=0, High=on)
MSG 002	External control of output. Output off (F-94=1, Low=on)
MSG 003	F-93 is not zero. Unable to calibrate.
LOCK F-19	F-19 is not zero. Unable to turn the output on.

LED Display Format

Use the following table to read the LED display messages.

0	1	2	3	4	5	6	7	8	9	A	B	C	D
0	1	2	3	4	5	6	7	8	9	A	b	C	d
E	F	G	H	I	J	K	L	M	N	O	P	Q	R
E	F	G	H	I	J	K	L	M	N	O	P	Q	R
S	T	U	V	W	X	Y	Z	()	+	-	,		
S	T	U	V	W	X	Y	Z	()	+	-	,		

INDEX

Accessories	11	LED conversion	118
Caution symbol	4	List of features	10
Cleaning the instrument	6	Messages	118
Configuration		Model differences	9
normal function settings		Power on/off	
operation	21	safety instruction	5
overview	21	Rear panel diagram	17
power on configuration operation	22	Remote control	29
table	24	Command list	52
Connector plug manufacturer ..	19	Command syntax	49
DECA SwitchLab	19	Error list	106
Display format	118	GPIB configuration	31
Disposal instructions	6	Status registers	95
EN61010		USB configuration	30
measurement category	5	Remote control function check ..	34
pollution degree	6	Realterm	35
Environment		Service operation	
safety instruction	6	about disassembly	5
Error messages	118	Socket server examples	
Ethernet		C++	46
interface	32	LabVIEW	48
sockets	33	Visual basic	45
web server	32	Socket server function check	39
Front panel diagram	14	UK power cord	7
Ground		Warning symbol	4
symbol	4	Web server function check	39