

Muti-Range Bench-Top DC Power Supply

PSB-2000 series

User Manual

GW INSTEK PART NO. 82SB-28H00E01



ISO-9001 CERTIFIED MANUFACTURER

GW INSTEK

Copyright Statement

This manual contains proprietary information, which is protected by copyright. All rights are reserved. No part of this manual may be photocopied, reproduced or translated to another language without prior written consent of Good Will company.

The information in this manual was correct at the time of printing. However, Good Will continues to improve products and reserves the rights to change specification, equipment, and maintenance procedures at any time without notice.

Good Will Instrument Co., Ltd.
No. 7-1, Jhongsing Rd., Tucheng Dist., New Taipei City 236, Taiwan.

Table of Contents

SAFETY INSTRUCTIONS	5
GETTING STARTED.....	9
PSB 2000 Series Overview	10
Appearance	17
OPERATION.....	32
Connecting the AC Power Cable.....	32
Connecting the Load to the Output Terminals	32
Operation Ranges (PSB-2400L, 2800L, 2400L2, 2800LS)	40
Operation Ranges (PSB-2400H, 2800H)	41
Various Settings	42
Menu Key Functions	49
Voltage Sense	73
External Control Functions	75
Using the Sequence Function	85
OTHER FUNCTIONS.....	88
Display in Alarm Status	88
Frame Link Controlled Parallel Operation (excluding PSB-2400L2)	90
Frame Link Controlled Series Operation (excluding PSB-2400L2, PSB-H series)	92
Power Extension using PSB-2800LS (Parallel Connection Only)	93
Using the PSB-007 Extension kits	94
EXTERNAL CONTROL	98
Remote Control	98
Interface Connectors	99

PSB-001 Specifications (optional)	99
PSB-002 Specifications (standard)	100
Connection Methods	101
Connection Cables	103
Address Setting	104
Using the Interface Boards	107
Communication Commands	110
Registers	132
APPENDIX	142
Trouble Shooting	142
Maintenance	144
Dimensions	146
Specifications	149
Declaration of Conformity	160

S SAFETY INSTRUCTIONS

This chapter contains important safety instructions that you must follow during operation and storage. Read the following before any operation to insure your safety and to keep the instrument in the best possible condition.

Safety Symbols

These symbols may appear in the manual or on the instrument.



WARNING

Warning: Identifies conditions or practices that could result in injury or loss of life.



CAUTION

Caution: Identifies conditions or practices that could result in damage to the PSB or to other properties.



DANGER High Voltage



Attention Refer to the Manual



Protective Conductor Terminal



Earth (ground) Terminal



Do not dispose electronic equipment as unsorted municipal waste. Please use a separate collection facility or contact the supplier from which this instrument was purchased.

Safety Guidelines

General Guideline



CAUTION

- Do not place any heavy object on the unit.
- Avoid severe impact or rough handling that leads to damaging the unit.
- Do not discharge static electricity to the unit.
- Do not block the cooling fan opening.
- Do not perform measurements on circuits that are directly connected to mains power.
- Do not disassemble the PSB unless you are qualified.

(Measurement categories) EN 61010-1:2001 specifies the measurement categories and their requirements as follows. The PSB-2000 falls under category I.

- Measurement category IV is for measurement performed at the source of low-voltage installation.
- Measurement category III is for measurement performed in the building installation.
- Measurement category II is for measurement performed on the circuits directly connected to the low voltage installation.
- Measurement category I is for measurements performed on circuits not directly connected to Mains.

Power Supply



WARNING

- AC Input voltage range: 100VAC~240VAC, 1300VA Max
 - Frequency: 50Hz/60Hz
 - To avoid electrical shock connect the protective grounding conductor of the AC power cord to an earth ground.
-

Cleaning the power supply	<ul style="list-style-type: none">• Disconnect the power cord before cleaning the oscilloscope.• Use a soft cloth dampened in a solution of mild detergent and water. Do not spray any liquid into the oscilloscope.• Do not use chemicals containing harsh products such as benzene, toluene, xylene, and acetone.
Operation Environment	<ul style="list-style-type: none">• Location: Indoor, no direct sunlight, dust free, almost non-conductive pollution (Note below)• Relative Humidity: 30% to 80% (no dew or condensation)• Altitude: < 2000m• Temperature: 0°C to 40°C
<p>(Pollution Degree) EN 61010-1:2001 specifies pollution degrees and their requirements as follows. The PSB falls under degree 2.</p> <p>Pollution refers to “addition of foreign matter, solid, liquid, or gaseous (ionized gases), that may produce a reduction of dielectric strength or surface resistivity”.</p> <ul style="list-style-type: none">• Pollution degree 1: No pollution or only dry, non-conductive pollution occurs. The pollution has no influence.• Pollution degree 2: Normally only non-conductive pollution occurs. Occasionally, however, a temporary conductivity caused by condensation must be expected.• Pollution degree 3: Conductive pollution occurs, or dry, non-conductive pollution occurs which becomes conductive due to condensation which is expected. In such conditions, equipment is normally protected against exposure to direct sunlight, precipitation, and full wind pressure, but neither temperature nor humidity is controlled.	
Storage environment	<ul style="list-style-type: none">• Location: Indoor• Relative Humidity: 30% to 70% (no dew or condensation)• Temperature: -20°C to 70°C

Power cord for the United Kingdom

When using the power supply in the United Kingdom, make sure the power cord meets the following safety instructions.

NOTE: This lead/appliance must only be wired by competent persons

 **WARNING: THIS APPLIANCE MUST BE EARTHED**

IMPORTANT: The wires in this lead are coloured in accordance with the following code:

Green/ Yellow: Earth
Blue: Neutral
Brown: Live (Phase)



As the colours of the wires in main leads may not correspond with the coloured marking identified in your plug/appliance, proceed as follows:

The wire which is coloured Green & Yellow must be connected to the Earth terminal marked with either the letter E, the earth symbol (⊕) or coloured Green/Green & Yellow.

The wire which is coloured Blue must be connected to the terminal which is marked with the letter N or coloured Blue or Black.

The wire which is coloured Brown must be connected to the terminal marked with the letter L or P or coloured Brown or Red.

If in doubt, consult the instructions provided with the equipment or contact the supplier.

This cable/appliance should be protected by a suitably rated and approved HBC mains fuse: refer to the rating information on the equipment and/or user instructions for details. As a guide, a cable of 0.75mm² should be protected by a 3A or 5A fuse. Larger conductors would normally require 13A types, depending on the connection method used.

Any exposed wiring from a cable, plug or connection that is engaged in a live socket is extremely hazardous. If a cable or plug is deemed hazardous, turn off the mains power and remove the cable, any fuses and fuse assemblies. All hazardous wiring must be immediately destroyed and replaced in accordance to the above standard.

G E T T I N G S T A R T E D

The PSB series are variable output, high-performance, regulated, switching DC power supplies. They incorporate a high-frequency current suppression circuit and accept input voltages rated from AC100V to 240V without the need to switch inputs. They offer a wide voltage and current range within their maximum rated power envelope. They also have a variable constant power function. They have standard features such as voltage and current settings, an output on/off switch, monitor outputs and other functions via external connectors. The chassis is smaller overall than traditional power supplies to reduce the total work area. The dual channel model and the booster unit extend the series to cover a wider range of applications. The PSB series are also able to execute sequence programs that are written using the optional interface boards.

The optional interface boards also allow you to control the PSB series remotely from a PC using GPIB, RS232C or USB.

PSB 2000 Series Overview

Series line up

Product name	Voltage range	Current range	Power range
PSB-2400H	0V to 800V	0A to 3A	0W to 400W
PSB-2800H	0V to 800V	0A to 6A	0W to 800W
PSB-2400L	0V to 80V	0A to 40A	10W to 400W
PSB-2800L	0V to 80V	0A to 80A	10W to 800W
PSB-2400L2 (Dual channel type)	0V to 80V ×2CH	0A to 40A ×2CH	10W to 400W ×2CH
PSB-2800LS (Booster unit)	0V to 80V	0A to 80A	10W to 800W



■ 400W Type
PSB-2400L

■ 800W Type
PSB-2800L



■ 400W×2-Channel Type
PSB-2400L2



■ 800W Type
Booster unit
PSB-2800LS



■ 400W Type
PSB-2400H

■ 800W Type
PSB-2800H

Main Features

Multi-Range Output	Capable of a wide-range of voltage and current settings within the rated power envelope.
Constant-Power Control	Provides constant-power (CP) control in addition to constant-voltage (CV) and constant-current (CC) controls.
Power Factor Correction Circuit	A built-in power factor correction circuit ensures compatibility to a wide AC input voltage range from AC100V to 240V without the need to use a switch. It also suppresses harmonic current.
Rotatable Front Panel Controls	The front panel can be rotated by 90 degrees to allow the unit to be operated horizontally or vertically.
Output Off Timer Function	Turns the output off automatically after a preset amount of time has elapsed. This can be used to prevent the output from being left on inadvertently or to prevent over-charging.
Sequence (SEQ) Function	The Sequence function executes data read from a PC through one of the optional interface boards (PSB-001 and PSB-002). There are two operation modes for the sequence function: Manual mode (for step by step execution) and automatic mode (for automatic execution of up to 99 steps and 999 cycles).
Protective Functions	The power supplies have a number of protection functions. OVP, OCP and OHP. OVP and OCP protection can be set on the front panel.
Preset Functions (Three Settings)	Pressing a preset key directly selects a preset setting, which is set in advance.

Single Unit Control of Parallel/Series Operation	The PSB-L series uses a single power supply unit (acting as the master unit) to control all connected slave units for series or parallel operation. In parallel, up to 4 units can be controlled (including the master) to increase the total power. In series, a maximum of 2 units (including the master) can be used.
External Control Function	The external control function allows external voltage and resistance-based control, voltage and current monitoring, output on/off control, alarm output and CV/CC status output.
Interface Boards	<p>There are two optional interface boards for remote control.</p> <ul style="list-style-type: none">• PSB-001: GPIB and local bus board.• PSB-002: RS-232C, USB and local bus board. <p>Note also that one of these options must be used to program sequences for the PSB-L series. See page 85 for further details.</p>
Dual Channel Model (PSB-2400L2)	Equipped with two 400W output channels for a wide variety of applications.
Delay (DLY) Function: (PSB-2400L2 Only)	The delay function introduces a switching delay between channel 1 and 2. The delay function can set a rising delay (the time to turn on) and a falling delay (the time to turn off).
Tracking Function: (PSB-2400L2 Only)	The channel 2 setting is made equal to that of channel 1 when the tracking function is activated. Thereafter, both channels change synchronously.

Accessories

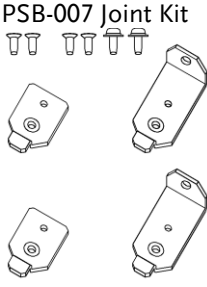
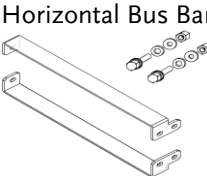
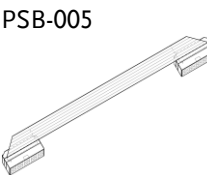
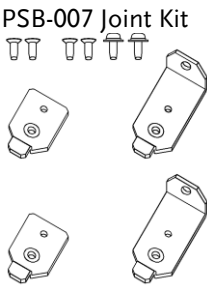
Model Number	Description
PSB-001	GPIB Control Board. Includes GRJ-1101 modular cables. For further details, see page 99.
PSB-002	RS-232C/USB Control Board. Includes GRJ-1101 modular cables. For further details, see page 100.
PSB-003	<p>Parallel Connection Kit for Horizontal Installation.</p> <p>Kit includes: PSB-007 Joint kit, Horizontal bus bar x2, PSB-005 x1.</p> <div data-bbox="669 451 876 738"> <p>PSB-007 Joint Kit</p>  </div> <div data-bbox="669 754 876 930"> <p>Horizontal Bus Bar</p>  </div> <div data-bbox="669 946 876 1121"> <p>PSB-005</p>  </div>
PSB-004	<p>Parallel Connection Kit for Vertical Installation.</p> <p>Kit includes: PSB-007 Joint kit, Vertical bus bar x2, PSB-005 x1.</p> <div data-bbox="669 1137 876 1425"> <p>PSB-007 Joint Kit</p>  </div>

Vertical Bus Bar

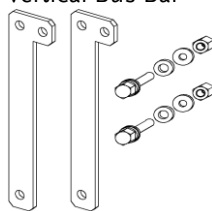

PSB-005

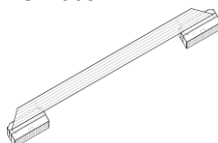

PSB-005 Parallel Connection Signal Cable

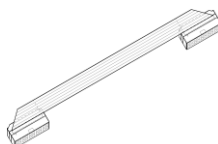

PSB-006 Serial Connection Signal Cable

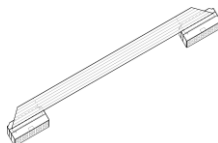

PSB-007 Joint Kit:
Includes 4 joining plates, 4X M3x6 screws, 2X M3x8 screws.

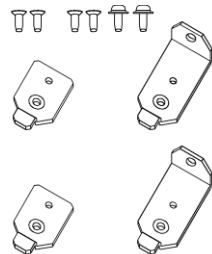

GRJ-1101 Modular Cables: 500mm 6P6C RJ11 (local bus cables)



Standard Accessories

Model Number	Description
	User Manual CD x 1
	AC power cable x 1
	Screws for output terminals on rear panel
	Protection covers for output terminals on rear panel
	Protection caps for output terminals on the front panel
	External control connector (26-pin)
	GND cable

Appearance

Front Panel (PSB-2400L2 shown)

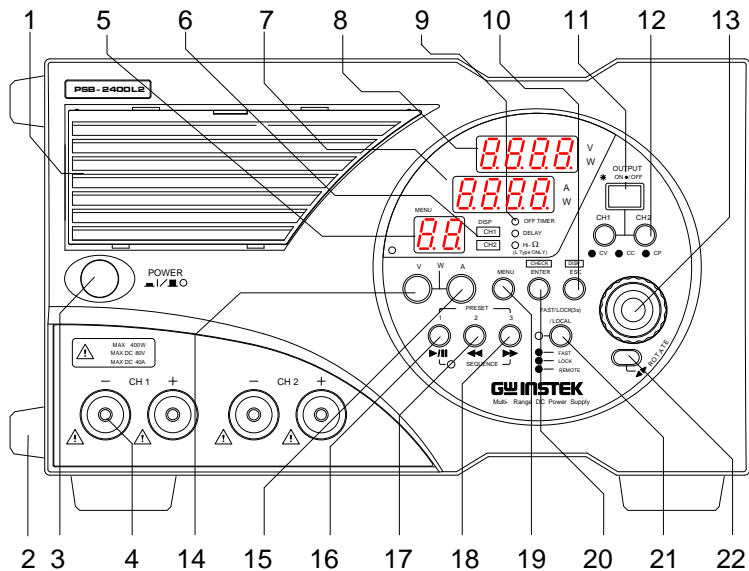

Front Panel (PSB-2400H shown)

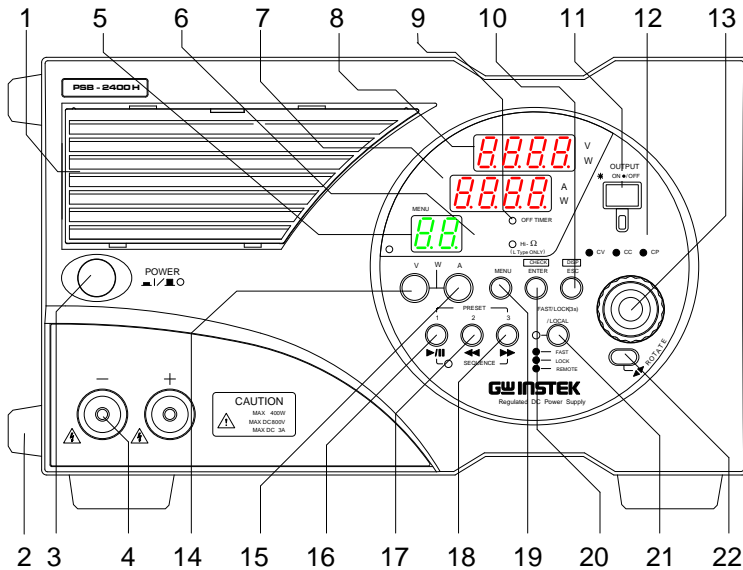

Item	Description
1 Front grill	This is a ventilation grill for for cooling the internal circuits. It is detachable and has a dust filter inside. Clean the filter periodically. See page 142.
2 Rubber feet	Detachable. If the unit is mounted in a rack and the feet are not needed, they may be removed.
3 POWER ON/OFF switch	Depress the switch to the (I) position to turn on the power supply unit. Press it again to turn off the unit.
4 Front output terminals	Output is supplied through these terminals. The maximum current is 40A(2400L, 2800L, 2400L2, 2800LS), 3A(2400H) or 6A(2800H).

Panel Operation Unit

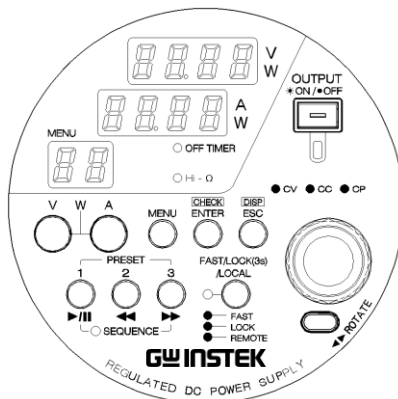

PSB-2400L, PSB-2800L
PSB-2400H, PSB-2800H

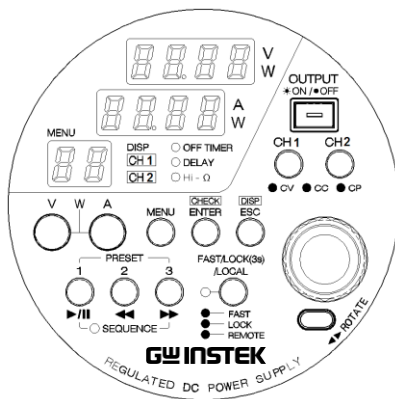

PSB-2400L2

Type	Description
------	-------------

5	Address no., Step no., cycle no., Menu no.	Normal operation	Sequence operation	Menu	Tracking
		Not displayed.	Number of steps or cycles is displayed.	Menu No. is displayed.	“Ab” is displayed.

6 Channel LEDs The LED of the selected channel is lit. Both LEDs are lit when the tracking function is activated.

7	Current LED (7-segment)	Normal operation	Sequence operation	Menu	Alarm
		Current or power is displayed.	Step No. is displayed.	Set item is displayed.	OVP, OCP, HARD or OHP is displayed.

The “W” LED on the right of the 7-segment LED is lit in the power display state.

8	Voltage LED (7-segment)	Normal operation	Sequence operation	Menu	Alarm
		Voltage or power is displayed.	Cycle No. is displayed.	Set parameter is displayed.	OVP, OCP, HARD or OHP is displayed.

The “W” LED on the right of the 7-segment LED is lit in the power display state.

9 Function LEDs These LEDs display the On/Off state of the OFF TIMER, DELAY or HiΩ functions. The LED is lit green when the corresponding function is activated.

10 ESC/DISP key (**ESC** / **DISP**) Changes the channel display, sequence operation display (i.e., step No. and cycle No.), remaining time for the off-timer and other displays. When the menu is displayed, pressing it exits the function selection mode and returns to the normal mode.













11 OUTPUT key (red) (**OUTPUT**) This key turns on or off the output. The LED is lit when the output is turned on.

12 CH1 and CH2 keys (red, green, orange) (**CH1**, **CH2**) These keys turn on or off the channel outputs. The color of the corresponding LED indicates the output mode.
Green: CV mode.

Red: CC mode.

Orange: CP mode.

The CH1 and CH2 keys are only available for the PSB-2400L2 only. The PSB-2400L and PSB-2800L have single LEDs only.

-
- | | | |
|----|----------------|---|
| 13 | Rotary encoder | Used to select the functions and change the values. |
|----|----------------|---|
-
- | | | |
|----|--|---|
| 14 | V key (green)
() | Used for setting the voltage. Press the key and rotate the encoder to change the set value. If the  key is pressed while holding the  key, both LEDs are lit and the Current LED enters the power display mode. |
|----|--|---|
- | | | |
|----|--|---|
| 15 | A key (green)
() | Used for setting the current. Press the key and rotate the encoder to change the set value. If the  key is pressed while holding the  key, both LEDs are lit and the Voltage LED enters the power display mode. |
|----|--|---|
- | | | |
|----|--|--|
| 16 | PRESET 1
key (green)
() | Reads out data stored in PRESET 1. Serves as a start/pause key () in the sequence mode. |
|----|--|--|
- | | | |
|----|--|---|
| 17 | PRESET 2
key (green)
() | Reads out data stored in PRESET 2. Serves as a back key () to skip to previous step number in the sequence mode. |
|----|--|---|
- | | | |
|----|--|---|
| 18 | PRESET 3
key (green)
() | Reads out data stored in PRESET 3. Serves as a forward key () to skip to the next step number in the sequence mode. |
|----|--|---|
- | | | |
|----|---|---|
| 19 | MENU key
() | Used for setting and selecting various functions. |
|----|---|---|

- 20 ENTER/
CHECK Key
(ENTER/
CHECK)
- Alternates the operation (and display) between the output value and the set value.
- When the output is on, every press of the **ENTER**/**CHECK** key alternates the display between the output value and set value.
- When the **V** key is lit → The voltage setting is enabled.
 - When the **A** key is lit → The current setting is enabled.
 - When the **V** and **A** keys are lit → the power setting is enabled.

When the menu is displayed, press this key to validate functions and values in the menu.

- 21 FAST/LOCK
(3s)/LOCAL
key (FAST)
- Changes the resolution of the voltage, current or power settings, locks panel operation, or switches the remote mode into the local mode. The color of the LED indicates the current status.
- FAST (green): The setting resolution is 1V, 1A or 100W.
- LOCK (3s) (red): Operations on the front panel are disabled.
- REMOTE (orange): Lit during communication through the optional interface boards.
-

- 22 ROTATE key
- The operating panel of the PSB-2000 series can be rotated 90 degrees so that the unit can be used in the horizontal or vertical position. Hold the encoder and rotate the panel operation unit while holding the key.

Rear Panel (PSB-2400L2 shown)

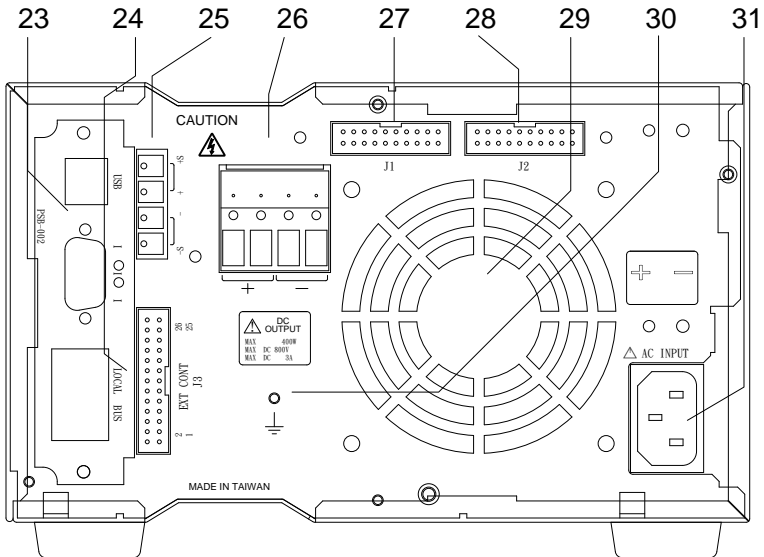
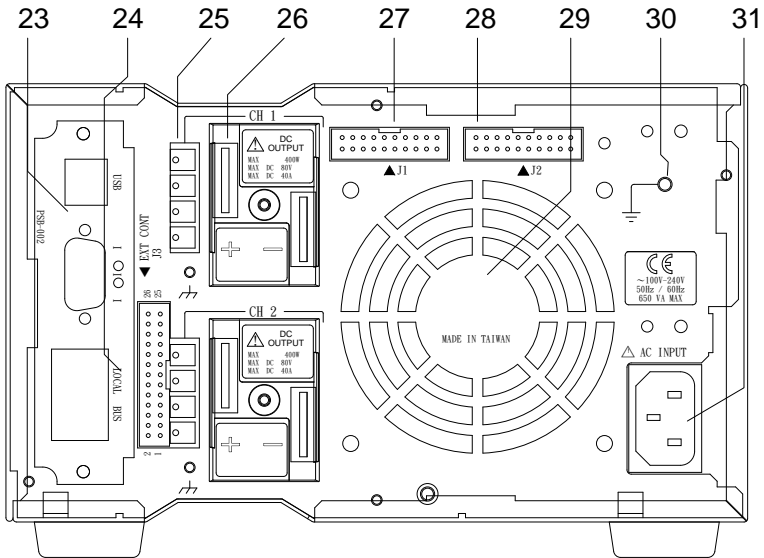

Description

23 Optional Interface board slot The optional interface board slot is used to install the optional PSB-001 board for the GPIB interface.

The product is supplied with the USB/RS-232C option as standard.

24 J3 external control connector The external control connector is used to control or monitor a number of different parameters using external components. The pin assignment of this connector can be found on page 26(40A models) 30(3A/6A models).

25 Sensing terminals The sensing terminals are used to change the sensing point. These terminals are short-circuited before shipment to select internal sensing.

26 Rear output terminals The Output of the PSB-2000 series power supply unit is also output through these terminals. The type of rear panel output terminal varies depending on the model. The PSB-2400H and PSB-2800H use pin terminals and the PSB-L models use crimp style voltages designed to accommodate higher current.

For the PSB-2400L2 (dual channel model), the channel 1 terminal block is in the upper part (CH1) and the channel 2 terminal block is in the lower part (CH2) of the rear panel when the unit is viewed from the back. On each terminal block, the positive (+) terminal is on the left and the negative (–) terminal is on the right when the unit is viewed from the back. Connect either output terminal to the screw marked with the ground signal  if it needs to be grounded with the chassis.

-
- | | | |
|----|-----------------------------------|---|
| 27 | J1 control signal input connector | This connector is used for parallel and serial control for master/slave operation. The optional frame link cables must be used with this connector. |
|----|-----------------------------------|---|
-
- | | | |
|----|------------------------------------|--|
| 28 | J2 control signal output connector | This connector is used for parallel and serial control for master/slave operation. The optional framelink cables must be used with this connector. |
|----|------------------------------------|--|
-
- | | | |
|----|---------------|--|
| 29 | Exhaust Grill | Air taken into the unit from the front is blown out through this grill. Leave a gap of a least 30cm or more behind the rear panel for good ventilation. If there is an object obstructing the rear panel, the temperature inside the power supply unit may rise excessively. |
|----|---------------|--|
-
- | | | |
|----|---|--|
| 30 | 
Functional ground terminal | The unit can be grounded using this terminal |
|----|---|--|
-
- | | | |
|----|----------|--|
| 31 | AC INPUT | Connect the AC power cable supplied with the unit with this plug receptacle and supply AC power to the unit. |
|----|----------|--|
-
- 25

Pin assignment of the J3 External Control Connector (PSB-2400L, 2800L, 2400L2, 2800LS)

Pin No.	Signal name	Function
1	CH2 STATUS COM (COM for 2, 3 & 4)	COM for pins 2, 3 and 4.
2	CH2 ALARM OUT	Open collector output. When the alarm is output for channel 2 then this pin is pulled low.
3	CH2 EXT CC STATUS OUT	Open collector output. Set to the low level when channel 2 is in CC mode.
4	CH2 EXT CV STATUS OUT	Open collector output. Set to the low level when channel 2 is in CV mode.
5	CH2 EXT CV CONTROL IN	Constant-voltage control input pin for channel 2.

In the external voltage control mode, an external voltage of 0V to 10V can be used to control the output voltage from ~0V to the rated output voltage.

In the external resistance control mode, an external resistance of 0k Ω to 10k Ω can be used to control the output voltage from ~0V to the rated output voltage.

6	CH2 EXT CC CONTROL IN	Constant-current control input pin for channel 2. In the external voltage control mode, an external voltage of 0V to 10V can be used to control the output current from ~0A to the rated output current. In the external resistance control mode, an external resistance of 0k Ω to 10k Ω can be used to control the output current from ~0A to the rated output current.
7	CH2 COM	COM pin for channel 2. Connected to the negative output terminal of channel 2.
8	CH2 EXT V MON OUT	Output voltage monitor pin for channel 2. Outputs a voltage of approximately 0V to 10V to represent 0V to the rated output voltage.
9	CH2 EXT A MON OUT	Output current monitor pin for channel 2. Outputs a voltage of approximately 0V to 10V to represent 0A to the rated output current.
10	CH2 COM	COM pin for channel 2. Connected with the negative output terminal of channel 2.
11	CH2 EXT ALARM IN	Causes the alarm state to be triggered when short-circuited with the CH2 COM pin.
12	CH2 EXT OUTPUT IN	This pin turns the CH2 output on when it is shorted to the CH2 COM pin.

13	CH2 COM	COM pin for channel 2. Connected with the negative output terminal of channel 2.
14	CH1 EXT CV CONTROL IN	Constant-voltage control input pin for the channel 1. In the external voltage control mode, an external voltage of 0V to 10V can be used to control the output voltage from ~0V to the rated output voltage. In the external resistance control mode, an external resistance of 0k Ω to 10k Ω can be used to control the output voltage from ~0V to the rated output voltage.
15	CH1 EXT CC CONTROL IN	Constant-current control input pin for channel 1. In the external voltage control mode, an external voltage of 0V to 10V can be used to control the output current from ~0A to the rated output current. In the external resistance control mode, an external resistance of 0k Ω to 10k Ω can be used to control the output current from ~0A to the rated output current.
16	CH1 COM	COM pin for channel 1. Connected with the negative output terminal of channel 1.
17	CH1 EXT V MON OUT	Output voltage monitor pin for channel 1. Outputs approx. 0V to 10V to represent 0V to the rated output voltage.

18	CH1 EXT A MON OUT	Output current monitor pin for channel 1. Outputs approx. 0V to 10V to represent 0 to the rated output current.
19	CH1 COM	COM pin for channel 1. Connected with the negative output terminal of channel 1.
20	CH1 EXT ALARM IN	Causes the alarm state to be triggered when short-circuited with the CH1 COM pin.
21	CH1 EXT OUTPUT IN	Turns on the CH1 output when short-circuited with the CH1 COM pin.
22	CH1 COM	COM pin for channel 1. Connected with the negative output terminal of channel 1.
23	CH1 EXT CV STATUS OUT	Open collector output. Set to the low level when channel 1 is in CV mode.
24	CH1 EXT CC STATUS OUT	Open collector output. Set to the low level when channel 1 is in CC mode.
25	CH1 ALARM OUT	Open collector output. Set to the low level when channel 1 is in the alarm mode.
26	CH1 STATUS COM (COM of 23, 24 & 25)	COM for pins 23, 24 and 25.

Pin assignment of J3 external control connector (PSB-2400H, 2800H)

Pin No.	Signal name	Function
13	NC	
14	EXT CV CONTROL IN	<p>Constant-voltage control input pin.</p> <p>In the external voltage control mode, an external voltage of 0V to 10V can be used to control the output voltage from 0V to 800V.</p> <p>In the external resistance control mode, an external resistance of 0kΩ to 10kΩ can be used to control the output voltage from 0V to 800V.</p>
15	EXT CC CONTROL IN	<p>Constant-current control input pin.</p> <p>In external voltage control mode, an external voltage of 0V to 10V can be used to control the output current from 0A to 3A(400H) or 6A(800H).</p> <p>In the external resistance control mode, an external resistance of 0kΩ to 10kΩ can be used to control the output current from 0A to 3A(400H) or 6A(800H).</p>
16	COM	<p>COM</p> <p>Connected with the negative output terminal.</p>
17	EXT V MON OUT	<p>Output voltage monitor pin.</p> <p>Outputs approx. 0V to 10V to represent the output voltage from 0V to 800V.</p>

18	EXT A MON OUT	Output current monitor pin Outputs approx. 0V to 10V to represent the output current from 0A to 3A(400H) or 6A(800H).
19	COM	COM Connected with the negative output terminal.
20	EXT ALARM IN	Trigger the alarm state when short-circuited with the COM pin.
21	EXT OUTPUT IN	Turns on the output when short-circuited with the COM pin.
22	COM	COM Connected with the negative output terminal.
23	EXT CV STATUS OUT	Open collector output. Set to the low level when the channel is in CV mode.
24	EXT CC STATUS OUT	Open collector output. Set to the low level when the channel is in CC mode.
25	ALARM OUT	Open collector output. Set to the low level when the channel is in the alarm mode.
26	STATUS COM	COM for pins 23, 24 and 25.

O PERATION

This chapter describes the start up procedures and the preparation that is necessary before operating the DC power supply.

Connecting the AC Power Cable

- Introduction
- Make sure that the power source is shut off.
 - Use the AC power cable supplied with the product.
 - Plug the connector of the AC power cable into the AC INPUT receptacle on the rear panel.

Connecting the Load to the Output Terminals

- Introduction
- Use cables with a rated voltage that exceeds the grounding voltage (500V) for the load.
- The front output terminals and rear output terminals are electrically connected internally. When the front output terminals are used, the rear output terminals are also active. Put the protective covers supplied with the product on the rear output terminals to avoid electrocution.



CAUTION

Make sure that the load is only connected when the POWER switch is off.

To connect a load, use cables that have a large enough current capacity for the rated output and current in order to prevent a fire.

The current capacity of the cables should be higher

still if the cables are twisted to reduce noise or to avoid malfunctioning.

Be careful of the temperature!



Connecting to the Rear Output Terminals (PSB-2400L, 2800L, 2400L2, 2800LS)

- Procedure
1. Remove the AC cable from the AC INPUT.
 2. Connect crimped lug terminals to the ends of the load cables. Tighten the lug terminals firmly using the nuts supplied with the power supply.



CAUTION

The rear output terminals have M6 holes and M3 (tapped) holes.

Be sure to use the M6 holes to connect the load. Noise at the load end may be reduced by twisting the load cables or connecting a film capacitor (several μF , low-impedance, high-frequency) and an electrolytic capacitor (several hundred μF) to the load end.

Fig. Connection with Rear Output Terminals

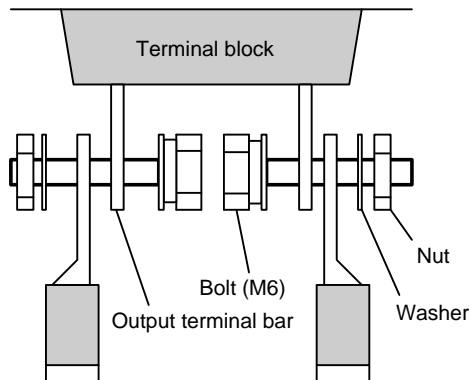

**Note**

Connect the cables using the bolts supplied with the power supply as shown above. If different bolts are used, they may contact the protective cover or interfere with the protective cover. The lug terminals must be be on the outside of the output terminals.

3. Connect the positive or negative output terminal to the GND screw with the  symbol using the GND cable supplied with the product as the necessity requires.

**Note**

The negative potential of the external voltage control pin is the same as that of the negative output terminal. If the power supply unit is grounded at the positive terminal and the power source for external control is grounded at the negative terminal, the load cables for external voltage control will short-circuit the output of the power supply unit, which could damage the unit. In this situation, make sure the external voltage control source is floating with respect to the output terminals.

Fig. Positive Grounding Connection

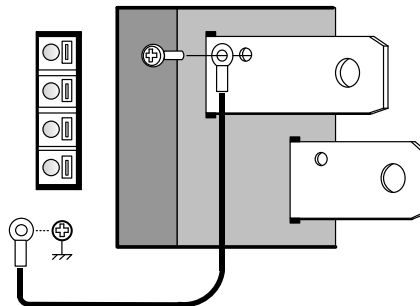

Connect with this screw

4. Sandwich the output terminals and the load cables from above and below with the rear output terminal protective covers, as shown below. Drive the screw into the protective covers at the center.

Fig. Attaching
Rear Output
Terminal
Protective Covers

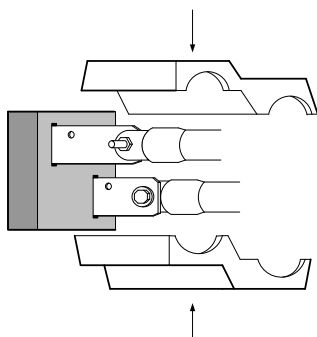

CAUTION

Make sure that the protection covers are always attached to the terminals even when they are not being used.

The front and rear output terminals are electrically connected internally. Touching a terminal that is not protected may induce an electric shock.

The rear output terminals have M6 holes and M3 (tapped) holes. Be sure to use the M6 holes to connect the load. Noise at the load end may be reduced by twisting the load cables or connecting a film capacitor (high-frequency, low-impedance (several μF) and an electrolytic capacitor (several hundred μF) to the load end.

5. Cut the shaded parts shown below with cutting pliers or the like to connect the power supplies in series or in parallel or to ground the output.

Fig. Parts to be cut

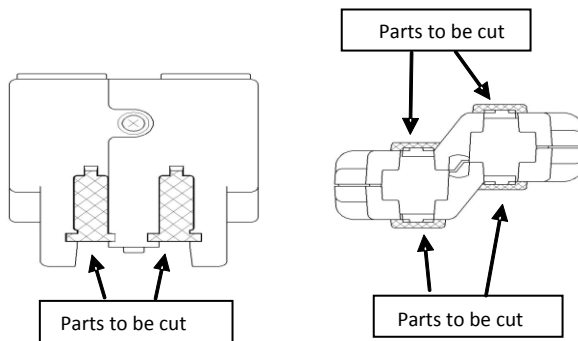

Connection with the Rear Output Terminals (PSB-2400H, 2800H)

Procedure

1. Remove the AC cable from the AC INPUT.
2. Insert the load line and then use a flathead screwdriver or similar tool to firmly secure it.
3. If necessary, use the supplied output ground cable and screw to establish a positive or negative ground connection to the output ground terminal (\perp mark).



CAUTION

Noise at the load end may be reduced by twisting the cables to the load or connecting a film capacitor (low impedance, high-frequency, several μF) and an electrolytic capacitor (several hundred μF) to the load end.

Fig. Connection with Rear Output Terminals

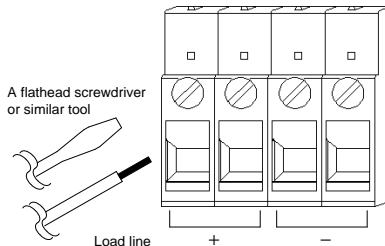

! Note

The negative potential of the external voltage control is the same as that of the negative output terminal. If the power supply unit is grounded at the positive terminal and the power source for external control is grounded at the negative terminal, the load cables for external voltage control will short-circuit the output of the power supply unit, which could damage the unit. In this situation, make sure the external voltage control source is floating with respect to the output terminals.

Fig. Positive Grounding Connection

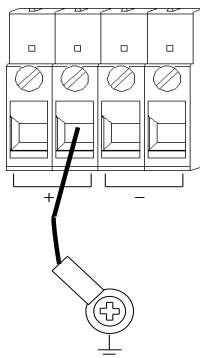

! CAUTION

The front and rear output terminals are electrically connected internally. Terminals that are NOT in use still carry output voltage.

Be careful not to touch the terminals. Failure to heed this warning may result in electric shock.

Connection with the Front Output Terminals (PSB-2400L, 2800L, 2400L2, 2800LS)

- Procedure
1. Turn on the unit using the POWER switch.
 2. Connect crimped lug terminals to the ends of the load cables. Fix the load cables firmly to eliminate loose connections from the front output terminals and load cables.
 3. If current is output through the rear output terminals, cover the front output terminals with the protective caps for safety.

Fig. Connection with Front Output Terminals

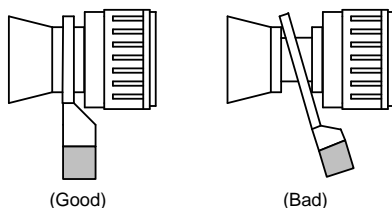

CAUTION

- The power supply unit may output a maximum of 40A through the front output terminals. Do not use pin plugs or banana plugs for outputting large current in order to avoid overheating due to contact resistance. Use lug terminals that meet the output current rating and connect them firmly to the front output terminals.
- For safety, NEVER output power through both the front and rear output terminals.

Assembling and Connecting the Front Output Terminal Plugs (PSB-2400H, 2800H)

- Procedure
1. Insert the cable (load line) into the plug.
 2. Use a 1.5 mm hex key to fasten the 2 screws.
 3. Insert the cover into the plug and make sure it hooks into place (completion image).
 4. Turn the power switch off from the unit.
 5. Insert the above-mentioned plug into the front output terminal.
 6. When current is drawn from the rear output terminals, the plug must be removed from the front output terminal.

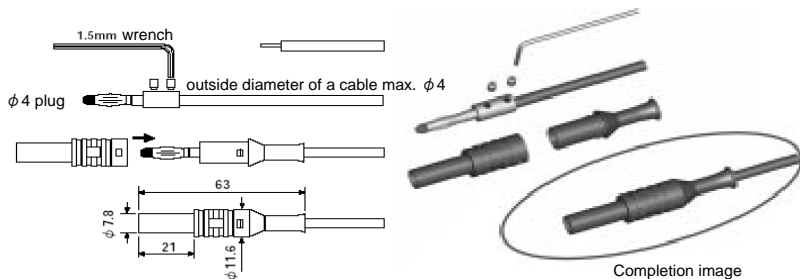

Fig. Assembly diagram of the front output terminal plug



CAUTION

For safety, never output power through both the front and rear output terminals.

Operation Ranges (PSB-2400L, 2800L, 2400L2, 2800LS)

Introduction The PSB-2000 series power supply units offer wider voltage and current range settings, within the rated power envelope, than our traditional models.

- Voltage setting range: 0V to 80V (All models)
- Current setting range: 0A to 40A (PSB-2400L & PSB-2400L2)
0A to 80A (PSB-2800L & PSB-2800LS)
- Power setting range: 10W to 400W (PSB-2400L & PSB-2400L2)
10W to 800W (PSB-2800L & PSB-2800LS)

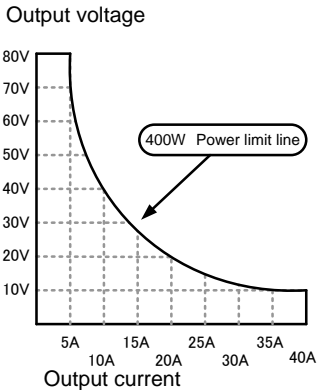

Fig. PSB-2400L/L2 Operation Range

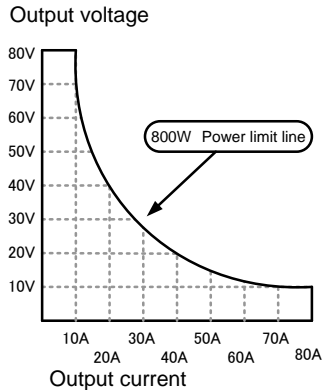

Fig. PSB-2800L/LS Operation range

Operation Ranges (PSB-2400H, 2800H)

- Voltage setting range: 0V to 800V (All models)
- Current setting range: 0A to 3A (PSB-2400H)
0A to 6A (PSB-2800H)
- Power setting range: 0W to 400W (PSB-2400H)
0W to 800W (PSB-2800H)

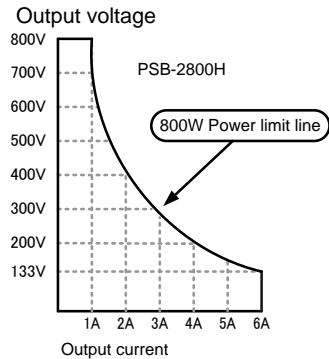
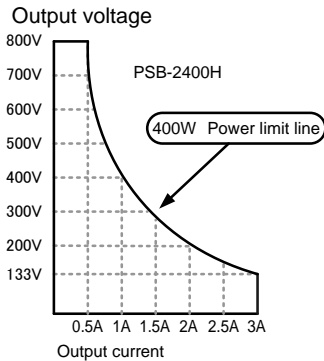

Fig. Operation Range of PSB-2400H

Operation Range of PSB-2800H

Various Settings

Turning the Power On

Introduction First, press the POWER switch to turn on the power. The power supply unit will show the startup screen (firmware version and models) for several seconds and then displays the last-used settings.



Note

The unit saves the last-used settings automatically when the power supply source is cut off or the POWER switch is shut off.

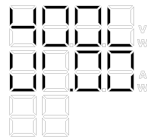

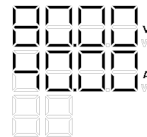

Model PSB-2400L,
version 1.00



The last-used
settings are
displayed

How to Set the Voltage

Procedure 1. Make sure that the  key is lit green. If not, press the  key to turn it on.

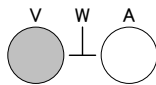

2. Set the voltage level with the encoder wheel.

Note Check which channel is selected before setting the voltage on the PSB-2400L2 in order not to change the set value of the other channel.

How to Set the Current

Procedure

1. Make sure that the **A** key is lit green. If not, press the **A** key to turn it on.

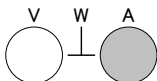

2. Set the current with the encoder wheel.

How to Set Power

Procedure

1. Make sure that both the **V** and **A** keys are lit. If not, press the **V** and **A** keys to turn them on. (Both keys need to be lit when setting the power.)

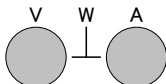

If the **A** key is pressed while keeping the **V** key depressed, the Current LED display can be used to enter the power setting. (The “A” indicator will turn off and the “W” indicator will turn on, indicating that the setting has changed from current to power.) See the figure below, “Voltage and Power”.

If the **V** key is pressed while keeping the **A** key depressed, the Voltage LED display can be used to enter the power setting. (The “V” indicator will turn off and the “W” indicator will turn on, indicating that the setting has changed from voltage to power.) See the figure below, “Current and Power”.

2. Set the power with the encoder wheel.

Fig. Power Display

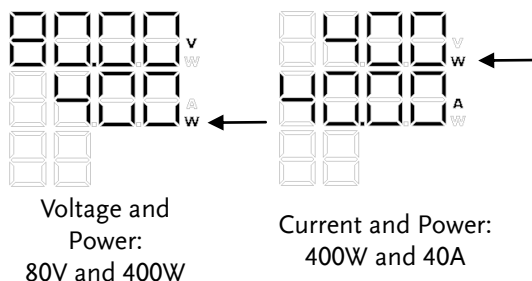

How to Turn the Output On

- Output Methods
- Turning the output on or off using the **OUTPUT** key.
 - Turning the output on or off using the **CH1** or **CH2** key (PSB-2400L2 only).
 - Turning the output on or off using the external control function.

Note

If the output is quickly turned off then on, then it is possible that the voltage will not discharge normally. Please allow the output to be off for a least 1 second before turning the output on again.

- Procedure
1. Turning the output on or off using the **OUTPUT** key.

Press the **OUTPUT** key to turn the output on or off. The Output is on while this key is lit. On the PSB-2400L2, pressing the **OUTPUT** key turns on or off the outputs for channel 1 and channel 2 simultaneously, but only if the **CH1** **CH2** keys have been pressed beforehand to select channel 1 or B.
 2. Turning the output on or off using the **CH1** **CH2** key. (PSB-2400L2 only)

The **CH1** and **CH2** keys are independent of each other, and it is possible to turn the output on through channel 1 or B by pressing the **CH1** or **CH2** key to select the corresponding channel. However, the output is disabled unless the **OUTPUT** key is lit.

Note For the PSB-2400L2, if neither the **CH1** nor **CH2** key is lit, the **OUTPUT** key will not go on even if it is pressed. (No output is provided.)

Fig. Output by Pressing **OUTPUT** key

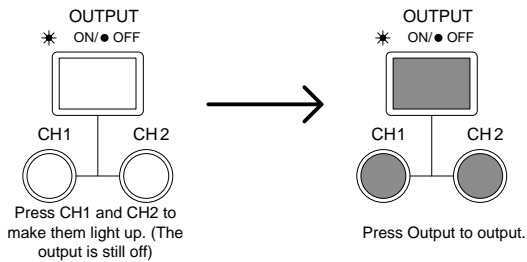

How to Display the Setting Value When the Output is On

Output methods The power supply unit displays the output value when the output is on. Press the **ENTER/CHECK** key when the output is on to switch the display to the setting value.

Procedure Every press of the **ENTER/CHECK** key toggles the display between the setting mode and output mode.

When the output is on and the mode has been switched to the setting mode, the **A** or **V** key blinks, indicating that the setting value is being displayed.



Note

The setting value is changed if the encoder wheel is rotated in the setting mode. The output value is changed if the encoder is rotated in the output mode. Do not touch the encoder to check the setting values.

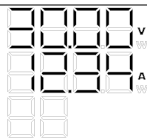

Output value

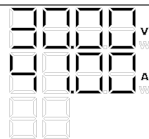

Press CHECK:
Set value

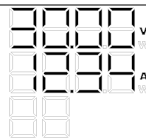

Press CHECK:
Output value

How to Rotate the Display Panel 90 Degrees for Vertical Installation

The display panel on the PSB-2000 series can be rotated 90 degrees so that the unit can be operated comfortably in either the horizontal or vertical orientations. Hold the encoder wheel and rotate the orientation of the panel while pressing the ROTATE key below the encoder wheel. Keep turning the panel until a “click” sound is heard. This indicates that the panel is now locked in place.

**CAUTION**

Be sure to confirm that the POWER switch is off before rotating the display panel. If the display panel is rotated with the power on, the set value may change due to the rotation of the encoder wheel.

Fig. Rotating Display Panel

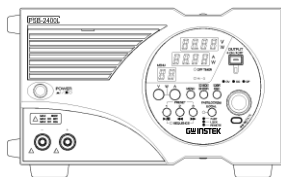

Horizontal installation

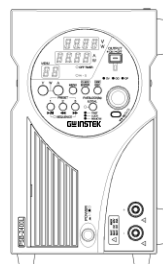

Vertical installation by rotating the display panel

How to Disable Panel Operations (Key Lock Function)

Operation It is possible to disable the front panel keys by pressing the FAST/LOCK(3s)/LOCAL key on the left of the encoder. Hold this key for three or more seconds to lock the panel keys. The keys are locked when the LED beside the key turns red. To cancel the key lock function, hold the FAST/LOCK(3s)/LOCAL key for 3 or more seconds.



CAUTION This key serves as the FAST, LOCK (3s), and LOCAL keys. When putting the power supply into the locked state, it will also automatically cancel the FAST mode setting (if set) and restore the power supply to the SLOW mode.

In the key-locked state, the OUTPUT key is still functional so that the output can be turned off for safety reasons.

Menu Key Functions

- Introduction
- Every press of the **MENU** key changes the menu numbers:
 - PSB-2400L, 2800L, 2800LS: **MENU** Option "01" to "07".
 - PSB-2400L2: **MENU** Option "01" to "09".
 - PSB-2400H, 2800H: **MENU** Option "01" to "06".
 - Press the **ESC**/**DISP** key to return from the **MENU** settings to the normal settings.
 - To deactivate a function, select the corresponding setting again from the menu and deactivate it.
-
- Operation Overview
- **MENU** key: Cycles through the menu options.
 - **ENTER**/**CHECK** key: Validates numeric values and items.
 - **ESC**/**DISP** key: Exits from the menu settings and returns to the normal settings.
 - Encoder wheel: Selects numeric values and items.
-

The diagram below can be used as a reference for the menu operations in the following pages:

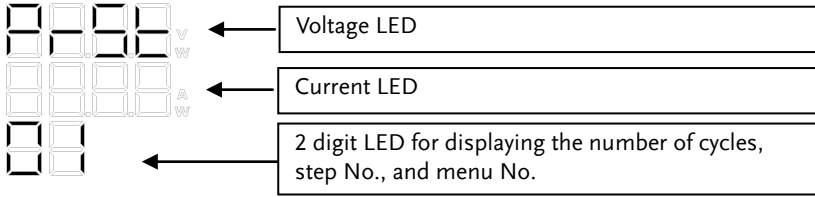

General Setting Procedure

1. Press the **MENU** key until an intended function number is displayed.
2. Press the **ENTER**/**CHECK** key to validate the function. Proceed to setting of the next item.
3. Set a numeric value or item with the encoder, and press the **ENTER**/**CHECK** key to validate it.
4. When all intended items have been set, press the **ESC**/**DISP** key to return to the normal state.



CAUTION

Set values are only validated after the ENTER / CHECK key is pressed. Be sure to check that the value is set properly after setting it. Some functions may not be settable as some functions cannot be used together. See the table below for details.

Set function	Functions that cannot be set or used simultaneously
Preset	Sequence External(voltage/resistance)
OVP/OCP	-
Hi-Ω (PSB-L Series Only)	-
Off timer	Sequence Delay External (On/Off)

Sequence	Preset Off timer External (voltage/resistance) External (On/Off) Delay Tracking
External (voltage/resistance)	Preset Tracking
External (On/Off)	Off timer Delay
Delay (PSB-L Series Only)	Sequence Off timer
Tracking (PSB-L Series Only)	Sequence External (voltage/resistance) External (On/Off)

Preset Function

Menu Item: 01 (All Models)

Introduction This function saves settings to one of the three PRESET keys. The settings shown below may be preset. Note that any other settings/values may not be saved.

- Set voltage
 - Set current
 - Set power
-

- Procedure**
1. Set the voltage/current/power settings that you want saved.
 2. Press the **MENU** key until menu number "01" is displayed.
 3. Press the **ENTER**/**CHECK** key. All the PRESET keys blink green.
 4. Press the PRESET key that you want to assign the current settings to. The PRESET key that you press will be lit a solid green to indicate that the save was successful.
 5. Press the **ESC**/**DISP** key to return to normal operation.
-



CAUTION

Once the **MENU** key is pressed to activate the preset function, you can no longer set the voltage, current and power. Set the intended values before

activating the preset function.

OVP/OCP function

Menu Item: 02 (All Models)

Introduction

- **OVP: (Over Voltage Protection)**
The OVP function turns off the output when the output voltage of the PSB-2000 series exceeds the preset OVP value.

Model	Setting Range	Resolution
PSB-2400L PSB-2800L PSB-2400L2 PSB-2800LS	1.0V to 84.0V	0.1V
PSB-2400H PSB-2800H	10.0V to 840.0V	1V

- **OCP: (Over Current Protection)**
The OCP function turns off the output when the output current of the PSB-2000 series exceeds the preset OCP value.

Model	Setting Range	Resolution*
PSB-2400L PSB-2400L2	1.0A to 42.0A	0.1A
PSB-2800L	1.0A to 84.0A	0.1A
PSB-2400H	0.1A to 3.15A	0.01A
PSB-2800H	0.1A to 6.30A	0.01A

*The resolution may be different for parallel/serial operation. Please see the specifications for details.

Procedure

1. Press the **MENU** key until menu number "02" is displayed.

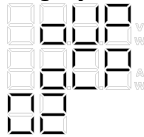

2. Press the **ENTER**/**CHECK** key to toggle between the OVP and OCP setting displays. On the PSB-2400L2, the OVP and OCP settings for channel 1 appear first, followed by channel 2 next.

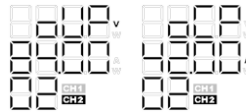
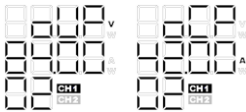
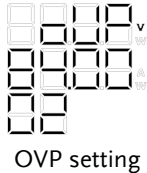

OVP and OCP setting of channel 1

OVP and OCP setting of channel 2

3. When the intended protection function is displayed (OVP or OCP), rotate the encoder wheel to set the OVP or OCP level.
4. Press the **ENTER**/**CHECK** key to confirm. The setting is now complete.
5. Press the **ESC**/**DISP** key to return to the normal operation.

Hi- Ω - Function

Menu Item: 03 (PSB-L Series Only)

Introduction The PSB-2000 series power supplies have filter capacitors connected to the output. The PSB-L power supplies also have a bleeder circuit to discharge these capacitors to a safe level when the output is turned off. When the Hi- Ω function is activated, the bleeder circuit is deactivated. This allows you to omit reverse-current preventing diodes that are necessary for charging batteries or capacitors when a bleeder circuit is active.

When the Hi- Ω function is activated, the internal filter capacitors can remain charged even after the power has been turned off and thus can be quite dangerous. As a safety measure, the bleeder circuits are programmed to turn back on after a predetermined amount of time (5 ~ 30 minutes) after the output has been turned off.

Procedure 1. Press the **MENU** key until menu number "03" is displayed.

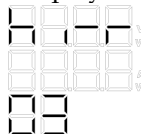

2. Press the **ENTER**/**CHECK** key to enter the Hi- Ω function setting mode. Select ON or OFF with the encoder wheel. The Hi- Ω function is set to OFF by default.

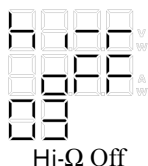

3. Press the **ENTER** / **CHECK** key to confirm the setting.
The Hi-Ω LED in the center of the panel turns on.
 - OFF TIMER
 - DELAY
 - Hi-Ω

4. Next, set the time limit for when the bleeder circuits are turned back on with the encoder wheel.
Setting range: 5~30 minutes.
Setting resolution: 5 minute steps.

Press the **ENTER** / **CHECK** key to confirm the setting.

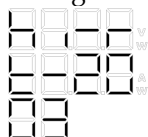

Example: Timer set for 20 minutes.

5. Press the **ESC** / **DISP** key to quit the setting mode and return to normal operation.

**CAUTION**

When the Hi- Ω function is activated, the output terminals of the power supply unit keep on carrying voltage even after the output is turned off.

The Hi- Ω LED will blink when Hi- Ω function is still active as the internal capacitors remain charged. Voltages as high as 80V may remain at the terminals when the output is turned off. Such a state is very dangerous. To avoid accidents, isolate the output terminals from the load cables completely with a relay or switch.

Off Timer Function

Menu Item: 04(PSB-L Series), 03(PSB-H Series)

Introduction This function turns the output off automatically after a set amount of time. The timer can be set in ten minute steps to a maximum of 99 hours, 50 minutes.

Procedure

1. Press the **MENU** key until menu number "04" is displayed(PSB-L) or "03(PSB-H series)

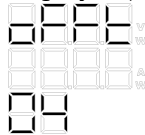

2. Press the **ENTER**/**CHECK** key to enter the Off Timer settings.
3. Select ON or OFF with the encoder wheel. The Off Timer is turned off by default.

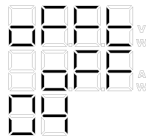

Initial setting

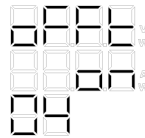

OFF timer activated

4. Press the **ENTER**/**CHECK** key to confirm the setting.
The OFF TIMER LED in the center of the panel will turn on when the timer is active.
 - OFF TIMER
 - DELAY
 - Hi-Ω
5. Next, set the timer time with the encoder wheel.
Press the **ENTER**/**CHECK** key to confirm the setting.

The timer may be set in steps of ten minutes to a maximum of 99 hours and 50 minutes. The OFF TIMER LED will blink when the remaining time is less than five minutes.

The remaining time for the off-timer may be checked by pressing the ESC/DISP key while the off-timer is running. (On the PSB-2400L2, pressing the ESC/DISP key toggles the display in the following order: CH1 settings, CH2 settings, and then the remaining time of the off-timer.)

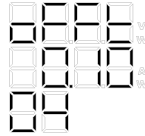

Example: Off Timer set to ten minutes

6. Press the **ESC** / **DISP** key to quit the setting menu and return to normal operation.

Sequence Function

Menu Item: 05(PSB-L), 04(PSB-H)

Introduction This function executes sequence programs. Please note that sequence programs can only be created when one of the interface boards (PSB-001 or PSB-002) are installed. Without an interface board installed, the sequence function is not available. Please see the PSB_Sequence_203 usermanual or the GW Instek website for more information on how to program sequences.

The following describes how to view steps in a previously-create sequence and screen shots of the PSB_Sequence_203 application that creates the sequences.

Note that the PSB series cannot edit or create sequences.

Fig. Repeating Steps 20 to 22 Three Times, Beginning with Step 20

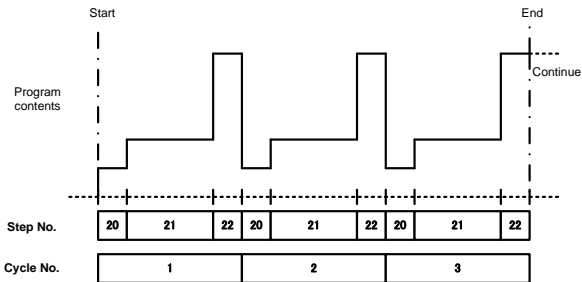



CAUTION

If the output is active at the end of the program as shown in the figure above, the power supply output will remain at the level of the last step even after the completion of the sequence operation. (I.e., the output stays active.)
 The last step number must be set to OFF for the the output to be turned off at the end of a sequence.

The sequence operation will end prematurely if the OUTPUT key pressed when a sequence is running. Note however, that the output will remain active at the level of the last step that was executed when the OUTPUT key was pressed.

Procedure

1. Press the **MENU** key until menu number "05" (PSB-L) or "4" (PSB-H) is displayed.

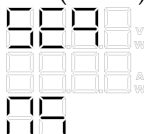

2. Press the **ENTER** / **CHECK** key to enter the sequence operation settings. Select ON or OFF with the encoder wheel. By default the sequence function is turned off.

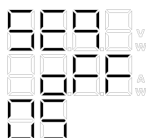

Initial setting

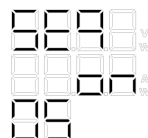

Sequence operation activated

3. Press the **ENTER** / **CHECK** key to confirm the setting.
 The SEQUENCE LED below the PRESET key turns on.

1 2 3



- Next, set the Start Step number with the encoder wheel.

Press the **ENTER**/**CHECK** key to confirm.
The setting range is from 0 to 99.

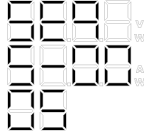

Example: The Start Step is set to No. "00".

- Set the End Step number with the encoder wheel.

Press the **ENTER**/**CHECK** key to confirm.
The setting range is from 0 to 99.

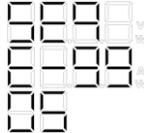

Example: The End Step is set to step No. "99".

- Set the number of times to repeat the steps above with the encoder wheel.

Press the **ENTER**/**CHECK** key to confirm.
Setting the sequence function is now complete.
The "---" setting repeats the steps infinitely.
The setting range is from 1 to 999 or "—" (infinite).

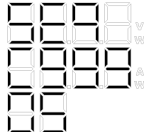

Example: Repeat the selected steps 999 times.

- Press the **ESC**/**DISP** key to quit the Sequence settings and enter the sequence operation

mode.

External Control (External Voltage, External Resistance)

Menu Item: 06(PSB-L), 05(PSB-H)

Introduction

- Constant-Voltage (CV) Control Using External Voltage

This function allows you to control the voltage of the PSB-2000 series power supply unit by applying an external voltage to the unit. An external voltage of 0V to 10V can be used to control the output voltage from ~0V to the rated output voltage.

- Constant-Current (CC) Control Using External Voltage

This function allows you to control the current of the PSB-2000 series power supply unit by applying external voltage to the unit. An external voltage of 0V to 10V can be used to control the output current from ~0A to the rated output current.

- Constant-Voltage (CV) Control Using External Resistance

This function allows you to control the voltage of the PSB-2000 series power supply unit by connecting an external resistance to the unit. An external resistance of 0Ω to 10kΩ can be used to control the output voltage from ~0V to the rated output voltage.

- Constant-Current (CC) Control Using External Resistance

This function allows you to control the current

of the PSB-2000 series power supply unit by connecting an external resistance to the unit. An external resistance of 0Ω to $10k\Omega$ can be used to control the output current from $\sim 0A$ to the rated output current.



CAUTION

The PSB-2000 series power supply unit is incapable of simultaneous external voltage and external resistance control.
 For example: Using an external voltage for CV control and external resistance for CC control is not supported.

Procedure

1. Press the **MENU** key until menu number "06" (PSB-L) or "05" (PSB-H) is displayed.

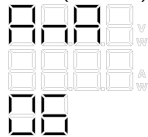

2. Press the **ENTER/CHECK** key to enter the external control settings. Use the encoder wheel to select external voltage or external resistance, and press the **ENTER/CHECK** key. By default the External Control is turned off.

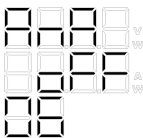

Initial setting

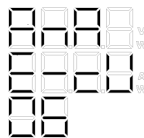

External voltage

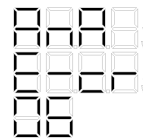

External resistance

3. Select the external control mode with the encoder wheel.
 The modes are listed below:
 CV= Constant voltage
 CC= Constant current
 IN = Control from the front panel or remotely from a PC.
 OUT= Control using the external control.

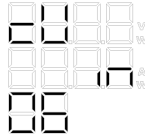

Controlling constant voltage
from the front panel

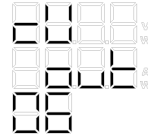

Controlling constant voltage
using external control

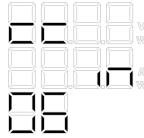

Controlling constant current
from the front panel

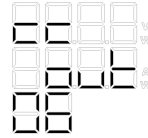

Controlling constant current
using external control

4. Finally, press the **ENTER** / **CHECK** key to validate the settings.
Setting the control mode is now complete.
5. Press the **ESC** / **DISP** key to quit the setting mode and return to normal operation.

External Control Output On/Off

Menu Item: 07(PSB-L, 06(PSB-H)

Introduction

The PSB series can use external control to turn the output on or off by shorting (output on) or opening certain pins (output off) on the external control connector.

Use this function to choose whether to use external control or the OUTPUT key to turn on the output.

Procedure

1. Press the **MENU** key until menu number "07" (PSB-L) or "06" (PSB-H) is displayed.

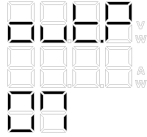

2. Press the **ENTER**/**CHECK** key to enter the external output On/Off control setting mode.
3. Select On or Off with the encoder wheel, and press the **ENTER**/**CHECK** key again to confirm the settings. The external output on/off setting is now complete. The output control modes are shown below:

IN= The output is controlled with the OUTPUT key.

OUT= The output is controlled with external contacts.

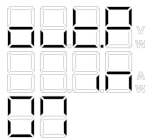

OUTPUT key control

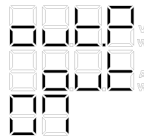

External Control

4. Press the **ESC**/**DISP** key to quit the settings and return to normal operation.

Delay Function

Menu Item: 08 (PSB-L2)

Introduction The delay function is available on the dual channel model (PSB-2400L2) only. It adds a rise and fall delay time to the output of channel 2 for a specified amount of time (in seconds) from a reference point (output of channel 1). The rise delay time refers to the delay time for turning the output on. The fall delay time refers to the delay time for turning the output off.

Fig. Temporal Concept of Delay Function

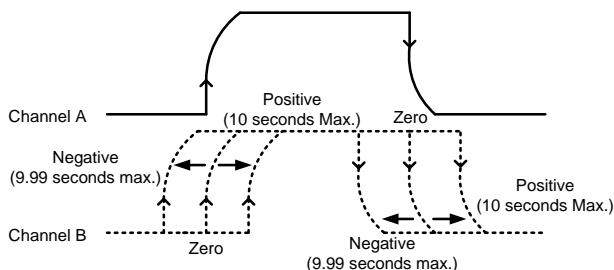

Procedure

1. Press the **MENU** key until menu number "08" is displayed.

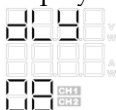

2. Press the **ENTER** / **CHECK** key to enter the delay function settings. Select On or Off with the encoder wheel. By default the delay setting is turned off.



3. Press the **ENTER** / **CHECK** key to confirm the setting.
 The DELAY LED in the center of the panel turns on.
 - OFF TIMER
 - DELAY
 - Hi-Ω

4. Set the rise delay time with the encoder wheel.
 When a positive time is set, the output of channel 2 is delayed with respect to channel 1. On the contrary, when a negative time is set, the output of channel 2 leads that of channel 1. The delay time can be set in the range of -9.99 seconds to +10.00 seconds in steps 10 ms.

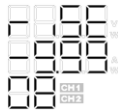

The output of channel 2 is turned on 9.99 seconds earlier



The output of channel 2 is turned on 10.00 seconds later.

5. Set the fall delay time with the encoder wheel, and press the **ENTER** / **CHECK** key. The delay function setting is now complete.

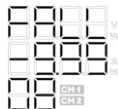

The channel 2 output is turned off 9.99 seconds earlier

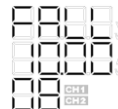

The channel 2 output is turned off 10.00 seconds later.

6. Press the **ESC** / **DISP** key to quit the delay settings and return to normal operation.

Tracking Function

Menu Item: 09 (PSB-L2)

Introduction The tracking function is available on the dual channel model (PSB-2400L2) only. When the tracking function is turned on, the output of channel 2 is made to match the output of channel 1, thus channel 2 can be said to “track” channel 1. This effectively means that the values of both channels change simultaneously.

Fig. Tracking Operation

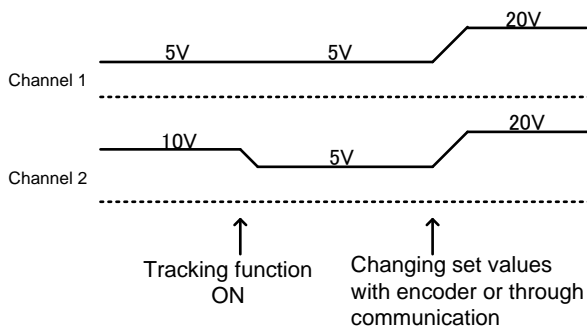

- Procedure**
1. Press the **MENU** key until the menu number “09” is displayed.
 2. Press the **ENTER** / **CHECK** key to enter the tracking function setting mode. Select On or Off with the encoder wheel. By default the tracking function is turned off.
 3. Press the **ENTER** / **CHECK** key to confirm the setting.
Both the CH1 and CH2 LEDs on the right of the channel LED turn on.
 4. Press the **ESC** / **DISP** key to quit the setting
-

menu and return to normal operation. "Ab" is displayed on the MENU LED when the tracking function is activated.

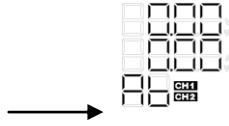

Example: Tracking function is activated.

Master-slave function

Menu Item: 10

The master-slave function allows the PSB series to operate in parallel or series (PSB-L only). For series operation a maximum of 2 PSB-L units can be used. For parallel operation, a maximum of 4 (PSB-L) units or 2 units (PSB-H) units can be used. Note that for series operation, the same PSB-L models types must be used.

For a slave unit that is connected in series, only the output voltages are displayed when the output is on.

No panel operations can be performed on the slave units. Only the Off Timer, Sequence and External Control function settings are initialized on the slave units.

For parallel connections "---" is displayed on the display for slave units. The monitor values are displayed on the master unit.



CAUTION

The Hi-Ω function is not available for master-slave operation.

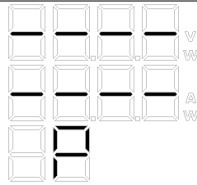

Display for a slave unit in a parallel connection

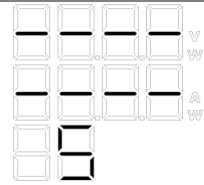

Display for a slave unit in a series connection

Procedure

1. The master-slave settings can be accessed by turning on the power switch while holding the **MENU** key.
2. Select the operation mode for the unit with the encoder wheel and press the **ENTER/CHECK** key to confirm the setting. By default the master-slave setting is set to OFF

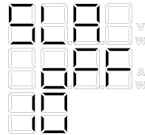

Initial setting:
Single unit operation or
Master unit in a series
connection

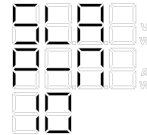

Master unit in a parallel
connection

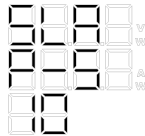

Slave unit in a parallel
connection

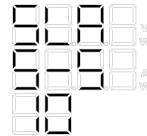

Slave unit in a series
connection (PSB-L only)

3. Set the total power with the encoder wheel if the unit is set as the master unit in a parallel connection.

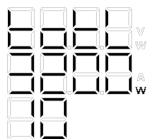

Example: Total power of 3200 W.

4. Press the **ESC** / **DISP** key to exit the settings and return to normal operation.

Voltage Sense

Description The PSB-2000 series power supply units have an output voltage remote sensing function. This function eliminates influences of voltage drops between the power supply unit and load, which is caused by the contact resistance or the resistance of the load cable conductors. Voltage sense compensates for a voltage of up to 1V on a single terminal.

**CAUTION**

When the voltage sense function is used, the voltage at the front or rear terminals of the power supply unit must not exceed the rated voltage.

If the load cables are long, the inductance and the capacity of the load cables may cause oscillation. To avoid oscillation, connect an electrolytic capacitor of a several hundred to several thousand μF to the load terminals.

- Procedure**
1. Make sure that the POWER switch is off before making any connections.
 2. Disconnect the wire that shorts the + and +S terminals or - and -S terminals on the four-terminal block on the left of the output terminals on the rear panel (this will need to be done for both channels on the PSB-2400L2).
 3. Connect the positive sensing terminal (+S) to the positive side of the load and the negative sensing terminal (-S) to the negative side of the load, as shown below. If the sensing wires are disconnected, control will become unstable and a voltage greater than the set voltage could be applied to the load. Connect the sensing wires
-

firmly.



NOTE

Approximately 1mA of current flows through the sensing wires at the rated output voltage. Use AWG 26 to 18 wires as the sensing wires.

Fig. Remote Sensing Connection (PSB-L)

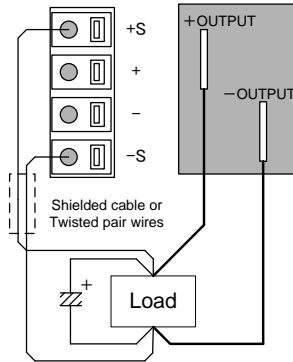
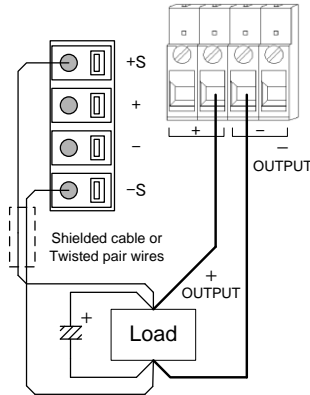

Fig. Remote Sensing Connection (PSB-H)



External Control Functions

Description	The following connectors are supplied with the power supply for external control.
-------------	---

Procedure	1. XG5M-2635-N (manufactured by OMRON Corporation) (For all PSB-2000 series)
-----------	--

This section describes how to assemble the external control connector

Assembling the XG5M-2635-N Connector

- | | |
|-----------|--|
| Procedure | <ol style="list-style-type: none">1. Remove the contacts from the housing.
Each contact can be easily removed by pulling it out while using a pin to hold down its catch. The contacts can also be removed using the XY2E-0001 removal tool (manufactured by OMRON Corporation).2. After connecting a wire to each contact, insert the contacts into the connector.
When inserting the contacts into the connector, ensure that the catch of each contact is firmly latched to the connector.
When connecting a wire to each contact, use the XY2B-7006 crimping tool (manufactured by OMRON Corporation).
Applicable wire:
Twisted wire AWG28 or 26
Outer diameter ϕ1.1 to 1.3 mm3. Mount semi-covers on both sides of the connector. |
|-----------|--|

Fig. Assembling the External Control Connector (XG5M-2635-N)

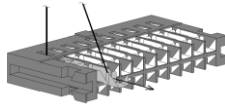

The 26-pin connector for external control: XG5M-2635-N (OMRON Corporation)
 Each contact can be easily removed by pulling it out while using a pin to hold down its catch.

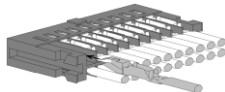

The XY2E-0001 contact removal tool (manufactured by OMRON Corporation), can also be used to remove the contacts.

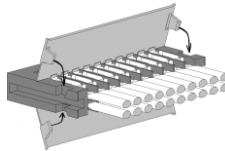

Applicable wire:
 Twisted wire AWG28 or 26
 Outer diameter ϕ 1.1 to 1.3 mm

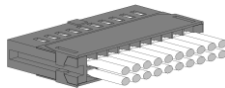

Mount the semi-covers on both sides of the connector. Here is a view of the completed assembly (20 pins shown)

Output Voltage Monitor and Output Current Monitor

Introduction

It is possible to monitor the output voltage and output current of the PSB-2000 series power supply unit using the J3 external control connector. This section describes how to monitor the output voltage and output current of the dual channel model (PSB-2400L2). The single channel models operate in the same manner as the description for the CH1 outputs.



NOTE

The internal impedance of the voltage and current monitoring circuits are approximately 1kΩ. Be careful not draw over 1mA through the monitoring circuits.

Procedure

1. Voltage monitor
CH1: Pins 17 and 16 (COM), CH2: Pins 8 and 7 (COM)
2. Current monitor
CH1: Pins 18 and 16 (COM), CH2: Pins 9 and 7 (COM)

Fig. Monitor Output Pins

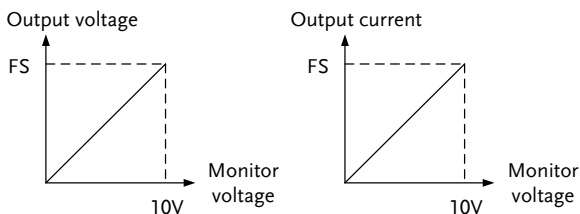
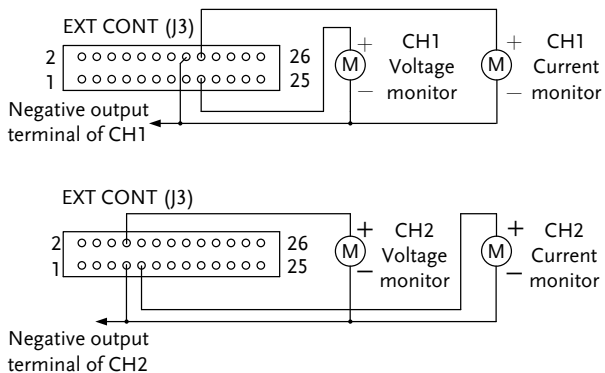

Constant-Voltage (CV) Control with External Voltage or Resistance

Introduction The output voltage can be controlled by an external voltage or resistance through the J3 external connection (EXT CONT) on the rear panel if external control is selected.

**CAUTION**

The negative side of the external voltage is connected with the negative output terminal of the power supply unit. Have the external voltage source floating to avoid accidents or malfunctions. If the external resistor is disconnected for some reason when operating in the external control mode, an excessively-high voltage could be applied to the output. This occurs as a disconnected resistor appears as an open circuit, which in turn is interpreted as a resistance of 10k Ω . If fixed resistances are used, use shorting-type switches to switch between the fixed resistances to avoid open circuits.

The pins used for external voltage control or for external resistance control are the same. Check with control method is selected (external voltage or external resistance), before connecting the pins.

External Resistance and External Voltage Control
Pins for voltage control:

CH1: Pins 14 and 16 (COM)

CH2: Pins 5 and 7 (COM)

Fig. External
Voltage/
Resistance
Control
Terminal (CV)

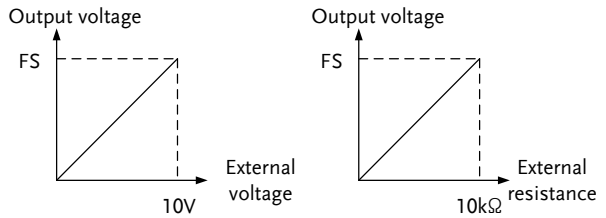
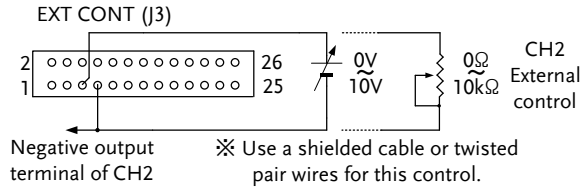
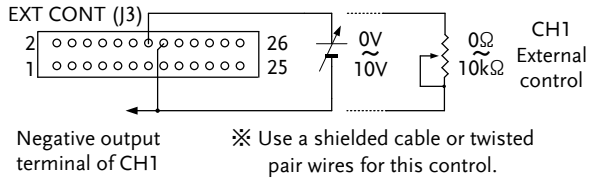

Constant-Current (CC) Control with External Voltage or Resistance

Introduction The current output can be controlled using an external voltage or external resistance through the connector J3 (EXT CONT) on the rear panel if external control is selected.

External Resistance and External Voltage Control Pins for current control:

CH1: Pins 15 and 16 (COM)

CH2: Pins 6 and 7 (COM)

Fig. External Voltage/Resistance Control Pins (CC)

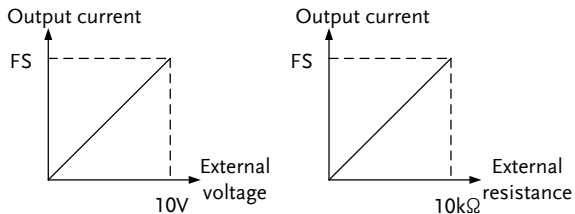
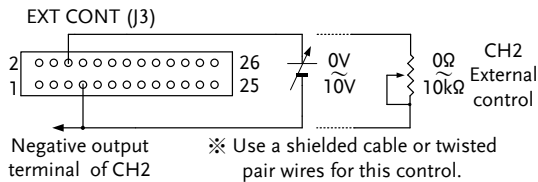
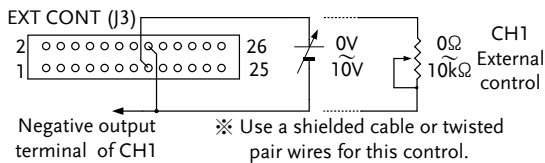

Output ON/OFF with External Contacts

Introduction The output can be turned on or off using external contact switches if the external control function is activated.

External Control Pins for Output ON/OFF control:

CH1: Pins 21 and 22 (COM)

CH2: Pins 12 and 13 (COM)

Short: OUTPUT ON

Open: OUTPUT OFF

Fig. Output ON/OFF Pins with External Contacts

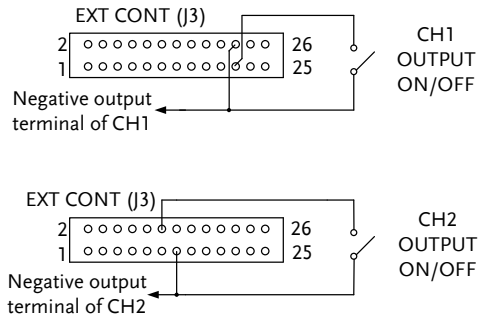

Alarm Function using External Contacts

Introduction An external contact switch can force the PSB-L into the alarm state. When in the alarm state, the output is turned off and “HARD” is displayed on the LED display. Remove the input power or turn off the power from the POWER switch to cancel the alarm state.

External Control Pins to activate the alarm state:

CH1: Pins 20 and 22 (COM)

CH2: Pins 11 and 13 (COM)

Fig. External Alarm Input Pins

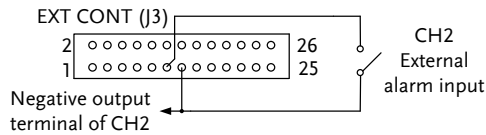
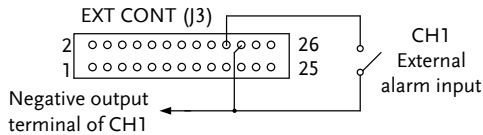

Status Signals (CV, CC & ALARM)

Introduction

- Constant-Voltage (CV) Status Signal

This status signal goes low when the PSB-2000 series power supply unit enters the constant-voltage (CV) status.

- Constant-Current (CC) Status Signal

This status signal goes low when the PSB-2000 series power supply unit enters the constant-current (CC) status.

- Alarm Status Signal

This status signal goes low when the PSB-2000 series power supply unit enters the alarm status.

Status Signal Characteristics (SHARP PC3H7 photocoupler)				
	Item	Symbol	Max. rating	Unit
Output	Collector-emitter voltage	V_{CEO}	66	V
	Emitter-collector voltage	V_{ECO}	6	V
	Collector current	I_C	50	mA
	Collector loss	P_C	150	mW
	Total allowable loss	P_T	170	mW
	Isolation voltage	BV_s	2500	V_{rms}
CH1: Constant-voltage (CV)status: Pins 23 and 26 (COM) Constant-current (CC)status: Pins 24 and 26 (COM) Alarm status: Pins 25 and 26 (COM)				
CH2: Constant-voltage (CV) status: Pins 4 and 1 (COM) Constant-current (CC) status: Pins 3 and 1 (COM) Alarm status: Pins 2 and 1 (COM)				

Fig. Status Pins

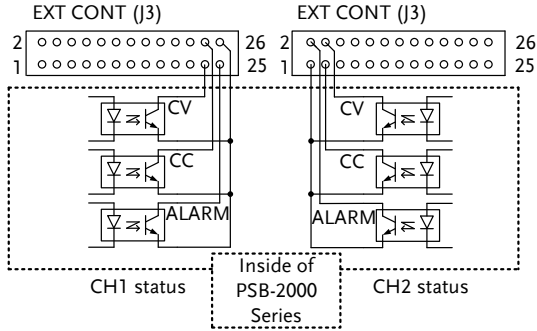
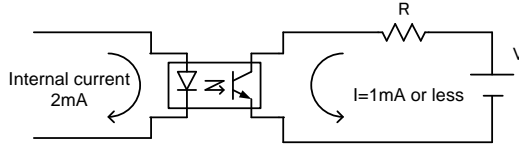

Fig. Photocoupler current



※ Select and use proper voltage or resistance so that the open collector current does not exceed 1mA.

Using the Sequence Function

Description The section “Sequence Function” (page 60) shows how to execute a sequence program on the power supply when equipped with the optional interface board. The PSB_Sequence_203 software is used to create a program in advance via the optional interface board. See the Sequence Function section on page 60 for details. The PSB_Sequence_203 software can be downloaded at the GW Instek website.

- Procedure**
1. Write a sequence program through the interface board. See page 60
 2. Activate the sequence function as shown in the Sequence Function menu on page 60.
 3. Execute the sequence operation with the **PRESET** key(s).
Each **PRESET** key has two functions. The function of the **PRESET** keys and the **OUTPUT** key are different when used in the sequence mode compared to when they are in the normal operating mode.

Below is a description of the function of each of the preset keys and the OUTPUT key when in the sequence mode.

Normal Mode	Sequence Mode
PRESET 1	Starts or pauses the sequence program. (▶/)
PRESET 2	Skips to the previous step number. (◀◀) (when paused)
PRESET 3	Skips to the next step number in the sequence. (▶▶) (when paused)

OUTPUT	Ends the sequence operation.
---------------	------------------------------



CAUTION The **OUTPUT** key does not the start sequence operation.
 Use the **PRESET 1** (▶/||) key to start the sequence operation. Even if the sequence function is activated and the “● SEQUENCE LED” is lit, the sequence operation will not start unless the **PRESET 1** (▶/||) key is pressed. Functions other than the preset function will work normally even when the “● SEQUENCE LED” is lit.
 If the **OUTPUT** key is pressed when a sequence is running, the sequence operation finishes. Note that ending a sequence operation is different from turning off the output in the normal operating mode.

- The display during a sequence operation is different from that in normal operation. The differences are shown below. When the **ESC** / **DISP** key is pressed during a sequence operation, the step number is displayed on the Voltage LED and the number of cycles is displayed on the Current LED. Press the **ESC** / **DISP** key again to return to the previous display.

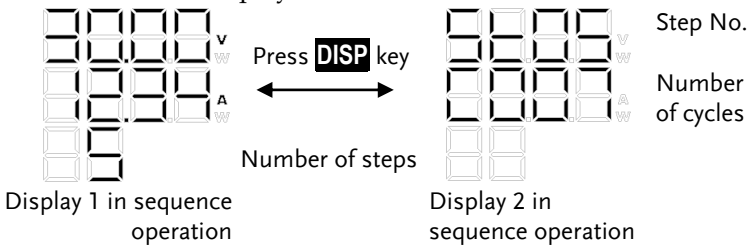

- During a sequence operation, the “● SEQUENCE LED” below the **PRESET** key blinks, indicating that sequence operation is being executed. To stop

the sequence operation partway, press the **OUTPUT** key or deactivate the sequence function as shown in the Section “Sequence Function”(page 60).

OTHER FUNCTIONS

Display in Alarm Status

Description When the PSB-2000 series power supply unit enters an alarm state or if the alarm state is manually set using the external control connector (see page 82), an alarm code is shown on the display. The alarm code will indicate what type of alarm has been triggered. When an alarm occurs, the power supply unit turns off the output and stays in the alarm state. When a protection function (excluding OVP and OCP, see page 53) is triggered, all operations (panel operation, etc.) are disabled and the power supply unit stops operation.

Press the **ESC** / **DISP** key for one second to reset the OVP or OCP alarm (see page 53). Reset the power from the AC input source or from the POWER switch to reset the protection functions.

(1) OVP alarm This alarm code is displayed if the output voltage exceeds the preset OVP value.

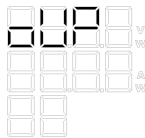

- (2) OCP alarm This alarm code is displayed if the output current exceeds the preset OCP value.

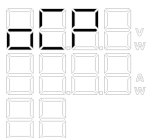

- (3) OHP alarm The OHP alarm is displayed if the temperature at an internal detection point exceeds a set temperature. The OHP alarm that is displayed differs from model to model, as shown below. For example, on the 2400L2, an OHP alarm is displayed for each channel.

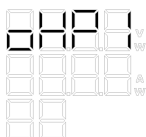

(2400L, 2400H
2800L, 2800H)

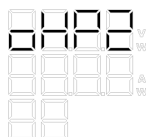

(2800L, 2800H)

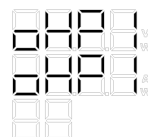

(2400L2)

- (4) HARD alarm The HARD alarm is displayed in the following conditions:

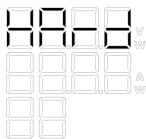

Cause	Description
Over-Voltage (OVP)	The output is turned off if the voltage exceeds 110% of the rated output voltage.
Over-Current (OCP)	The output is turned off if the current exceeds 110% of the rated output current.
Alarm using external contacts	An alarm is caused when the External Alarm Input Pins on the external control

ALARM	connector are shorted. For details, see page 82. PSB-L Only.
-------	--

Frame Link Controlled Parallel Operation (excluding PSB-2400L2)

Description The PSB Series power supply units are capable of frame link controlled parallel operation of up to four units(PSB-L), or up to 2 units (PSB-H) including the master unit. When performing parallel operation using master units, the master and slave units should be set properly in advance, see the Master-slave function chapter on page 70.

Connect the master and slave units with the optional parallel signal cables, PSB-005. The parallel connection kit for horizontal installation, PSB-003 or the parallel connection kit for vertical installation, PSB-004 can also be used to physically connect the units together. The joint kit, PSB-007, is included with the PSB-003 and PSB-004 connection kits. Use these kits as the necessity requires.

The sum of the master unit current and slave unit current is displayed on the master unit. See the specifications on page 155 for the displayed items and setting resolution for parallel operation.

Output depends on the master unit. When the OUTPUT key of the master unit is pressed, the outputs of the slave units are turned on automatically.



CAUTION The PSB-2400L2 is not capable of parallel operation.

! CAUTION Improper wiring or settings may cause failures. Recheck the settings before starting frame control operation.

If the load cables of a slave unit are disconnected, excessive voltage is applied to the slave unit instantaneously and a “HARD” alarm occurs. Check if the cables are connected properly. Repair improper connections. The master unit displays the total current. If the actual value is remarkably different from the set current and/or output current, improper power may possibly be set in the setting shown in the Master-slave function chapter on page 70. Recheck the set power.

When using frame link-controlled parallel operation, the current indicated on the master unit may fluctuate due to the influence of the load wire resistance. In such cases, use the optional connection kit, PSB-003 (Horizontal Installation Connection Kit), PSB-004 (Vertical Installation Connection Kit) or a low-impedance-load wire.

Use the PSB-2400L as the master unit when controlling the PSB-2400L and PSB-2800L using the the frame link control method.

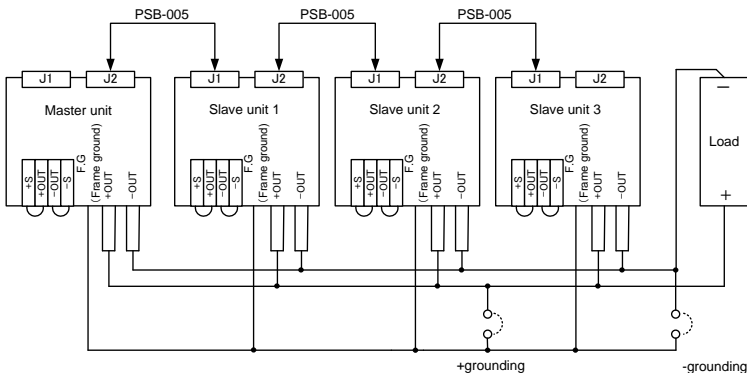

Frame Link Controlled Series Operation (excluding PSB-2400L2, PSB-H series)

Description The PSB-L series power supply (excluding the PSB-2400L2) units are capable of frame link controlled series operation of up to two units, including the master unit. When performing series operation using master units, the slave unit should be set properly in advance, see the Master-slave function chapter on page 70.

Output depends on the master unit. When the OUTPUT key on the master unit is pressed, the output of the slave unit is turned on automatically. Connect the master and slave unit with the optional PSB-006 cable.



CAUTION Improper wiring or setting may cause failures.

Recheck the setting before starting frame link control operation.

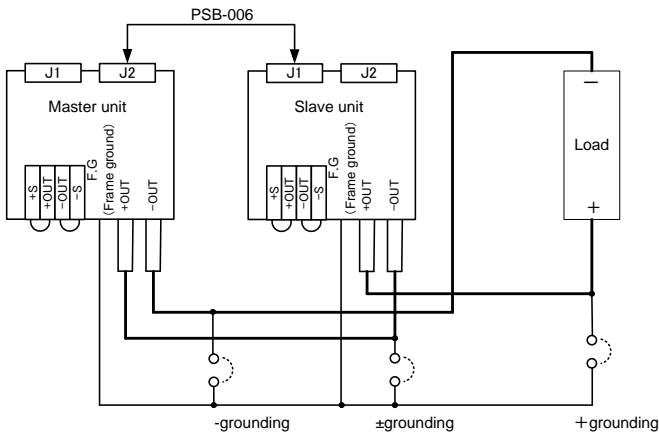

Power Extension using PSB-2800LS (Parallel Connection Only)

Description The PSB-2800LS (booster unit) is especially designed to boost the power capacity when used in parallel. It is possible to increase the output up to a maximum of 3200W when used in parallel with a PSB-2800L as the master unit).



NOTE

Note that the PSB-2800LS cannot be used for series operation.

Fig. Front and Rear panel of PSB-2800LS

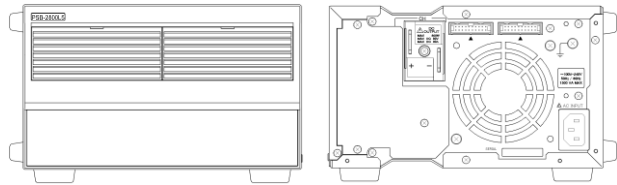

How to use the PSB-2800LS

Description The PSB-2800LS is not equipped with a power switch. The PSB-2800LS relies on a master unit to turn it on when it is connected in parallel. As soon as the master unit is turned on any connected PSB-2800LS power supply is also turned on (see page 70 for details).

In other words, the PSB-2800LS cannot be used alone. So before using the PSB-2800LS, check to make sure that the AC power cable, signal cables and load wires are connected properly. Improper wiring or settings may cause problems.

Fig. Connection
Example for
Horizontal
Installation

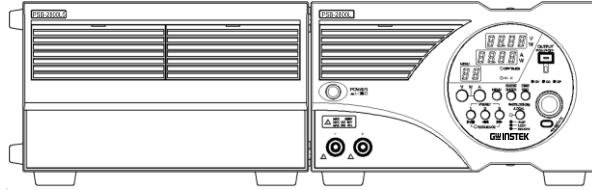
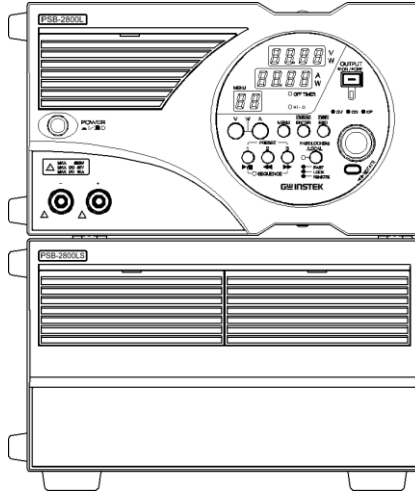

Fig. Connection
Example for
Vertical
Installation



Using the PSB-007 Extension kits

Description The PSB-007 extension kits allow master units to be physically connected to slave units. The extension kits can be used horizontally or vertically.



NOTE

Note that the PSB-2800LS cannot be used for series operation.

How to Connect the Units Vertically

- Steps
1. Remove the rubber feet from the bottom of unit A. (Keep the removed rubber feet and screws with care not to lose them.)
 2. Fix the joint kit (PSB-007) to the top panel of unit B with the flat countersunk head screws supplied with the kit. (Four positions)
 3. Place the units as shown in the figure below so that the prongs from the PSB-007 joint kit on the unit B are inserted in the holes in unit A (revealed from under the rubber feet that were removed).
 4. Slide unit A and fix the rear panel to the brackets on the joint kit (PSB-007) firmly with the screw with washer supplied with the kit. (Two positions)

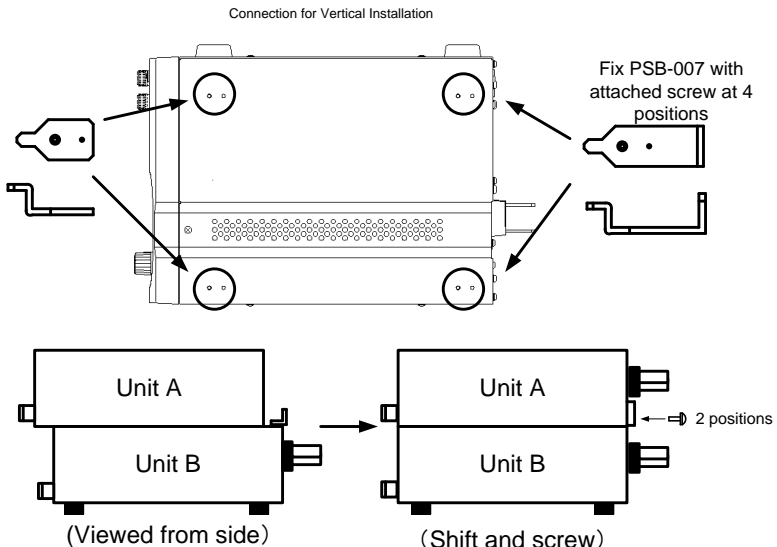

How to Connect the Units Horizontally

- Steps
1. Remove the rubber feet from the side of unit B. (Keep the removed rubber feet and screws with care not to lose them.)
 2. Fix the joint kit (PSB-007) to the side of the unit A with the flat countersunk head screws supplied with the kit. (Four positions)
 3. Place the units as shown in the figure below so that the prongs from the joint kit on unit A are inserted in the holes in unit B (revealed from under the rubber feet that were removed).
 4. Slide unit B, and fix the rear panel to the brackets of the joint kit (PSB-004) firmly with the screw with washer supplied with the kit. (Two positions)

Connection for Horizontal Installation

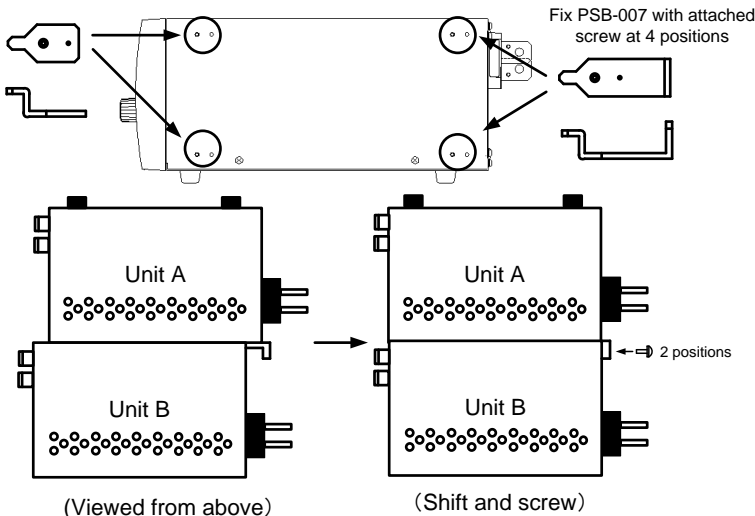

Bus Bar Connection

Fig. Bus Bar Connections to Fix the Output Terminals

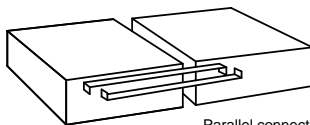

Parallel connection kit for Horizontal installation PSB-003

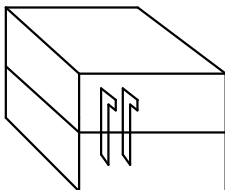

Parallel connection kit for vertical installation PSB-004

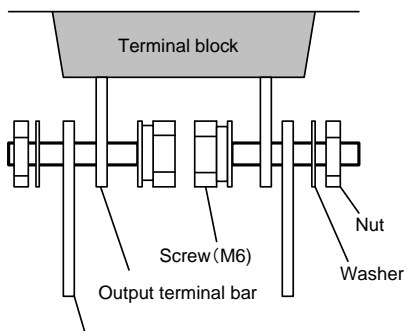

Bus bar

※ Pay attention to the positional relationship with the output terminal

EXTERNAL CONTROL

Remote Control

Description The PSB-2000 series power supplies can be controlled from a PC or sequencer when one of the optional interface boards are installed. Two types of interface boards are available: PSB-001 (GPIB) and PSB-002 (RS-232C and USB). A maximum of ten units to be connected together with the local bus connection, with one unit as a master unit. The master unit is then connected to a PC through GPIB, RS-232C or USB. Any connected units may be controlled as slave units.

**NOTE**

In this chapter, the terms “master unit” and “slave unit” are the same terms as used in the Power Extension section (page 90), however, in this chapter they have different meanings. Please, do not confuse them.

It is impossible to install one of the optional interface boards in the PSB-2800LS.

**NOTE**

The interface boards are factory installed options. If you need to install or remove the interface boards, please refer to the instruction manual supplied with the interface boards. For safety, make sure the power is off before installing the interface board.

Interface Connectors

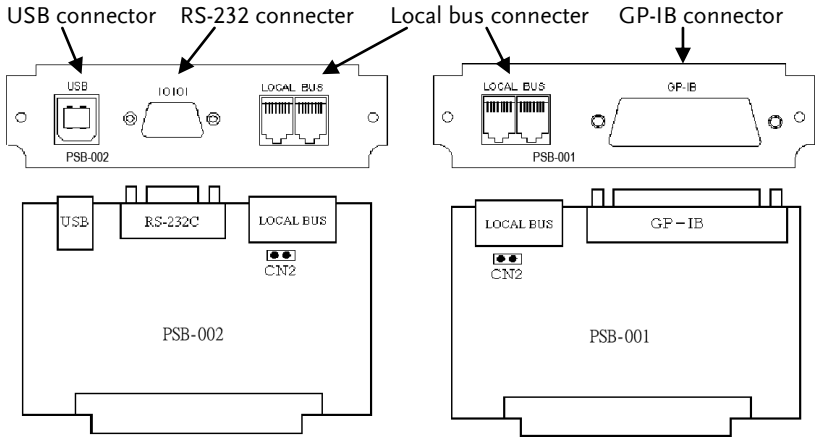

Fig. Diagram of the Interface Boards

PSB-001 Specifications (optional)

GPIB	
Specifications	Conforms to IEEE488-1978.
Interface functions	SH1, AH1, T6, L4, SR1, RL1, PR0, DC1, DT0, C0, & E1
Address setting	1 to 30
Delimiter	LF, EO1, & LF + EO1
Listener function	Output conditions of controlled power supply units may be set.
Talker function	Output conditions and setting conditions of controlled power supply units may be detected.
Service request function	Occurrence of alarms and errors and presence or absence of responses are reported.
Q'ty of connectable units	Maximum of 14 units are connectable with a single GP-IB card.
Local bus	
Specifications	Conforms to RS-485 Standards. Proprietary protocol.
Max. cable length	10 [m]

Connector type	RJ-11 (6-pin modular) Pin 2 (D+), pin 3 (D-)
Applicable cable	Modular cable: GRJ-1101 (500mm 6P6C RJ11)
Q'ty of connectable units	A maximum of 10 units can be connected in a daisy chain configuration.
Terminator	The terminator is built-in. It may be turned on or off with a jumper pin.
Q'ty of ports	2 ports, non-directional

PSB-002 Specifications (standard)

RS-232C	
Specifications	Conforms to the RS-232C Standards.
Data transmission speed	57600[bps]
Data bit	Data: 8 [bits], stop bit: 1 [bit], parity: none
Max. cable length	10[m]
Connector type	D-sub, 9-pin, plug
Applicable cable	Mass-marketed interlink cable (Socket 9-pin to socket 9-pin)
Q'ty of connectable units	One-to-one connection only

USB	
Specifications	Conforms to the USB Standards, Revision .2.0. Full speed: 12 [Mbps]
Connector type	USB series B
Device class	USB CDC/ACM Class.
Vendor code	2184
Product code	0031
Power supply	Self-powered only
Q'ty of connectable units	Maximum of 127 units are connectable through USB hubs.

Local bus	
Specifications	Conforms to the RS-485 Standards. Proprietary protocol.
Max. cable length	10 [m]
Connector type	RJ-11 (6-pin modular) Pin 2 (D+), pin 3 (D-)
Applicable cable	Modular cable: GRJ-1101 (500mm 6P6C RJ11)
Q'ty of connectable units	Maximum of 10 units are connectable through daisy chain connection.

Terminator	Built-in. May be turned on/off with jumper pin.
Q'ty of ports	2 ports, non-directional



NOTE

The PSB-001 and PSB-002 interface boards have the same local bus for connecting slave units, which may be equipped with either type of interface board.

Connection Methods

Description The following shows an example of connecting several PSB-2000 series power supply units through the local bus.

Fig. Local Bus Connection

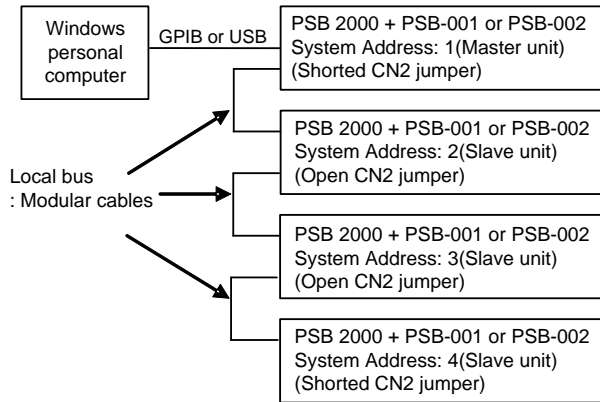

When connecting units together using the local bus connection, any of the local bus ports on the interface board can be used as the input or output.

Use the shortest modular cables possible to connect each unit. Terminate the start and end of the daisy-chain-connected units by shorting CN2 jumper pins on the interface boards with the shorting connectors¹. Disconnect the shorting connectors from all the other interface boards². Using the example figure above, "Local Bus Connection", the CN2 jumpers on System Addresses 2 and 3 should be removed.

¹ The interface board is short-circuited with the jumper pin before shipment.

² Keep the disconnected connectors. Do not discard them.

Connection Cables

- Procedure
- Use the proprietary modular cables for the local bus connection (GRJ-1101).
 - Use standard GPIB cables for the GPIB connections.
 - Use USB cables (applicable for Full Speed USB or greater) for the USB connections.
 - Use interlink cables for the RS-232C connection. The pin assignment is as shown below. Note that normal crossover cables may not be used.

Fig. RS-232C Cable Connection

		Personal computer			PSB-002	
D-Sub 9 pin socket	2	RxD	<—>	3	D-Sub 9 pin socket	
	3	TxD	<—>	2		
	4	DTR	<—>	6		
	5	GND	<—>	5		
	6	DSR	<—>	4		
	7	RTS	<—>	8		
	8	CTS	<—>	7		
	FG		<—>	FG		

Address Setting

Description The interface has two addresses: Personal Computer Address, and System Address. The type of address that is used depends on whether the unit is the master connected to a PC or a slave unit connected over the local bus. If the System Address is set to 1, then that unit is designated as the master unit. A Personal Computer Address can then be assigned to the master unit as well. Each slave unit should be assigned a System Address when connected to a master unit.



NOTE

The System Address of the unit directly connected to the PC must be 1.

The system is not guaranteed to operate if several slave units connected to the master unit have the same System Address.

Do not assign the same address to several slave units.

Address	Range	Remark
System Address	1 to 30	Address 1 is used for the master unit. Other addresses are for the slave units. The slave units connected to the master unit must have different System Addresses.
Personal Computer Address (GPIB address)	1 to 30	The Personal Computer Address may be set only when the System Address is set to 1. For the optional GPIB interface, it is the GPIB address. For the RS232 and USB interfaces, no Personal Computer Address is used.

Procedure

1. Turn on the unit while holding the **A** key to set the System Address and/or Personal Computer Address. The model name and version data are displayed first, and then the interface type is displayed. After this, the System Address may be set ¹. "Sy.Ad" is displayed on the Voltage LED, and the address is displayed on the Current LED. Rotate the encoder to select the System Address, and press the **ENTER** / **CHECK** key to confirm.

A unit whose System Address is set other than 1 will return to normal operation.

¹Keep the **A** key depressed until "Sy.Ad" is displayed.

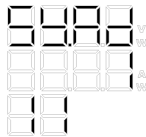

System Address 1

2. If the System Address is set to 1, "PC.Ad" is displayed on the Voltage LED, indicating that a Personal Computer Address can be set. Rotate the encoder to select the Personal Computer Address, and press the **ENTER** / **CHECK** key to confirm.

The unit will return to normal operation.

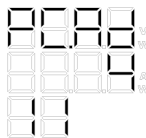

Personal Computer Address 4

3. The unit saves the System Address and Personal Computer Address in non-volatile memory. The System Address and Personal Computer Address will remain saved even if the power to the unit is turned off.

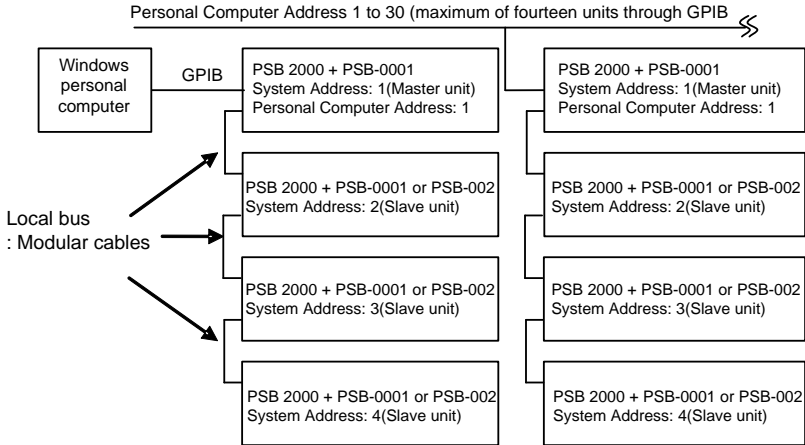

Use the PSB-002 interface board in the master unit when the USB interface needs to be used.

Using the Interface Boards

Using the GPIB interface

- Description
- All GPIB operations have been tested using a NATIONAL INSTRUMENTS GPIB controller and sample programs. All interface cards conforming to the IEEE488 standard should be compatible with the PSB-001 interface board. However, compatibility cannot be assured.
 - The PSB-001 accepts the following delimiters: LF (0×0A), EOI, and LF (0×0A) + EOI. It sends a response using LF (0×0A) + EOI only.
 - When using the local bus through GPIB, control must be returned to the master unit after transferring commands to the slave units². Unless control has been returned to the master unit, the GPIB controller on the PC may fail to recognize the interface board properly.
 - The Personal Computer Address may be set only when the System Address is set to 1. The Personal Computer Address is used to represent the GPIB address.

² Send ADDR1.

Using the USB interface

- Description
- You may use the USB port of your Personal computer for communication through the USB interface. Microsoft Windows 98SE, 2000, XP to Windows 8* may be used.
 - To use the USB interface, it is necessary to install the device driver.
 - This driver may fail to work properly if the host PC is in the suspend mode or sleep mode. The driver may not run at its full performance if the screen saver or another application is running.



NOTE

USB hubs are easily affected by external noise, which may cause errors. When using USB hubs try to self-powered hubs so that the connection is not affected by noise.

Installing the USB driver in Windows 8

*To install the USB driver in Windows 8, you must first disable "Device driver signature enforcement".

Use the following steps to disable device driver signature enforcement:

Go to the Charms bar → Click on Settings → Click on Power → Hold the SHIFT key and click Restart → Click Troubleshoot → Advanced Options → Startup Settings → Restart → Select 7) Disable driver signature enforcement. → The PC will now restart.

After the PC restarts, it will now be possible to install the USB driver on Windows 8.

Using the RS-232C Interface

- Description
- The serial port on a PC or sequencer can be used for communication through the RS232C interface. The interface uses CTS-RTS for flow control. Please note that with this type of communication, if the flow control fails to work properly, some characters may be lost, which may result in a malfunction or error.

Using the Local Bus

- Description
- The communication timeout time between the PC and master unit should be longer when the local bus is used. The communication time is influenced by the cable length. Check it and determine the time-out value.
 - Remember that when connecting units together using the local bus connection, any of the local bus ports on the interface board can be used as the input or output.



CAUTION A General Description About Communication

When you are going to control several PSB 2000 Series power supply units from a PC, the electrical potential of the frame of the power supply units must be equal to that of the PC frame. If those potentials are different, you may receive electric shocks or the PC may get damaged.

Communication Commands

- Description
- Every communication command consists of general alphanumeric characters and symbols and a header, which is the abbreviation of a function. Parameters can be either an integer (NR1) or a floating point number with decimal places (NR2). Parameters following the tenth character are ignored. Decimal places are rounded off according to the actual setting resolution. Responses contain no header. Only parameters are sent as responses.
 - LF (0x0A) is used as the delimiter, which indicates the end_of_data. Multiple commands consisting of several continuous commands are not applicable to the PSB 2000 Series power supply units. Thus, commands must be separated with delimiters. If delimiters are used, the interface unit automatically controls the flow of communication. Commands and queries are accepted whether they are written in capital letters or lowercase letters.
 - Use the address command “:ADDR” to specify a System Address of a slave unit when communicating with a slave unit on the local bus from the PC. Since address 1 has been set by default, the System Address of the master unit is to be specified.
 - Commands that are only applicable to the dual channel model (PSB-2400L2) will cause an error if they are used with a single channel model. If a command is to be used for either channel, “:A” or “:B” should be added to the command to specify which channel the command applies to. (:A represents CH1, :B represents CH2)

- An error occurs if a command causing a conflicting operation is sent while the sequence, tracking or external control function is working.

Command List

Category	Set item	Command	Query	Page	Function
Output Setting	Output voltage setting	:VOLT	:VOLT?	42	112
	OVP setting	:VOLT:PROT	:VOLT:PROT?	53	113
	Output current setting	:CURR	:CURR?	43	113
	OCP setting	:CURR:PROT	:CURR:PROT?	53	114
	Output power setting	:POW	:POW?	43	115
	Output ON/OFF	:OUTP	:OUTP?	44	116
Function	Hi- Ω ON/OFF	:CONF:HIZ	:CONF:HIZ?	55	117
	Hi- Ω time setting	:CONF:HIZ:HOLD	:CONF:HIZ:HOLD?	55	117
	Display switch	:CONF:DISP	:CONF:DISP?	42	117
	Tracking ON/OFF	:CONF:TRAC	:CONF:TRAC?	69	118
External control	External control setting	:EXT:MOD	:EXT:MOD?	63	119
	External voltage control	:EXT:VOLT	:EXT:VOLT?	63	119
	External current control	:EXT:CURR	:EXT:CURR?	63	121
	Output switching	:EXT:OUTP	:EXT:OUTP?	65	121
Off timer	Off timer ON/OFF	:TIMER:MOD	:TIMER:MOD?	58	122
	Off timer value setting	:TIMER:SET	:TIMER:SET?	58	122
Delay	Delay ON/OFF	:DELAY:MOD	:DELAY:MOD?	67	123
	Rise delay time	:DELAY:RISE	:DELAY:RISE?	67	123
	Fall delay time	:DELAY:FALL	:DELAY:FALL?	67	124
Status check	Monitor request	-----	:MEAS?	76	124
Preset	Call	:PRES:CALL	:PRES:CALL?	52	125
	Save	:PRES:SAVE	:PRES:SAVE?	52	125
Sequence	Sequence mode setting	:SEQ:MOD	:SEQ:MOD?	60	126
	Jump	:SEQ:STEP	:SEQ:STEP?	60, 85	126
	Start step	:SEQ:START	:SEQ:START?	60, 85	127
	End step	:SEQ:END	:SEQ:END?	60, 85	127
	Repetition frequency	:SEQ:CYCL	:SEQ:CYCL?	60, 85	127
	Data transfer	:SEQ:DOWNLOAD	:SEQ:DOWNLOAD?	---	128

Common	Model inquiry	-	*IDN?	---	128
	ESR query	-	*ESR?	---	129
	Event enable	*ESE	*ESE?	---	129
	STB query	-	*STB?	---	129
	SRQ enable	*SRE	*SRE?	---	129
	Clear	*CLS	-	---	129
	Reset	*RST	-	---	129
	Completion	*OPC	*OPC?	---	130
	Wait for completion	*WAI	-	---	130
Extension	Local communication	:ADDR	-	104	130
	Remote mode	:REMOTE	:REMOTE?	48	131

Output Voltage Setting (:VOLT)

This command sets or inquires about the output voltage.

Setting	:VOLT <value> Sets the output voltage of a single channel model. :VOLT:A <value> Sets the output voltage of CH1. :VOLT:B <value> Sets the output voltage of CH2. The <value> range is from 0.00 to 82.00 (PSB-L), 0.0 to 820.0 (PSH-H). Two decimal places are valid.
Application example	:VOLT 10.10 Sets the output voltage of a single channel model to 10.10V.
Query	:VOLT? Inquires about the set output voltage of a single channel model. :VOLT:A? Inquires about the set output voltage of CH1. :VOLT:B? Inquires about the set output voltage of CH2.
Response example	10.10 Indicates that the set output voltage is 10.10V.
Remark	When the tracking mode is on, setting CH1 will affect CH2. Setting CH2 in the tracking mode will cause an execution error.

OVP Setting (:VOLT:PROT)

This command sets or inquires about the OVP (over-voltage protection) value.

Setting	:VOLT:PROT <value> Sets the OVP value of a single channel model. :VOLT:PROT:A <value> Sets the OVP value of CH1. :VOLT:PROT:B <value> Sets the OVP value of CH2. The <value> range is from 1.00 to 84.00(PSB-L), 10.0 to 840.0(PSB-H). Two decimal places are valid.
Application example	:VOLT: PROT 10.10 Sets the OVP value of a single channel model to 10.10V.
Query	:VOLT:PROT? Inquires about the set OVP value of a single channel model. :VOLT:PROT:A? Inquires about the set OVP value of CH1. :VOLT:PROT:B? Inquires about the set OVP value of CH2.
Response example	10.10 Indicates that the set OVP value is 10.10V.
Remark	None

Output current setting (:CURR)

This command sets or inquires about the output current.

Setting	:CURR <value> Sets the output current of a single channel model. :CURR:A <value> Sets the output current of CH1. :CURR:B <value> Sets the output current of CH2.
---------	---

	<p>The <value> range for single-unit operation is as shown below: PSB-2400L & PSB-2400L2: 0.00 to 41.00 PSB-2800L: 0.00 to 82.00 PSB-2400H: 0.00 to 3.07 PSB-2800H: 0.00 to 6.15 Two decimal places are valid. The setting range changes when the power supplies are used in parallel. Resolution in parallel operation: 100mA Setting range: 0.0 to (total current x 1.025)</p>
Application example	<p>:CURR 10.10 Sets the output current of a single channel model to 10.10A.</p>
Query	<p>:CURR? Inquires about the set output current of a single channel model. :CURR:A? Inquires about the set output current of CH1. :CURR:B? Inquires about the set output current of CH2.</p>
Response example	<p>10.10 Indicates that the set output current is 10.10A.</p>
Remark	<p>When the tracking mode is on, setting CH1 will affect CH2. Setting CH2 in the tracking mode will cause an execution error.</p>

OCP setting (:CURR:PROT)

This command sets or inquires about the OCP (over-current protection) value.

Setting	<p>:CURR:PROT <value> Sets the OCP value of a single channel model. :CURR:PROT:A <value> Sets the OCP value of CH1. :CURR:PROT:B <value> Sets the OCP value of CH2.</p>
---------	--

	<p>The <value> range in single-unit operation is as shown below: PSB-2400L & PSB-2400L2: 1.00 to 42.00 PSB-2800L: 1.00 to 84.00 PSB-2400H: 0.10 to 3.15 PSB-2800H: 0.10 to 6.30 Two decimal places are valid. The setting range changes when the power supplies are used in parallel. Resolution in parallel operation: 100mA Setting range: 0.0 to (total current x 1.05)</p>
Application example	<p>:CURR:PROT 10.10 Sets the OCP value of a single channel model to 10.10A.</p>
Query	<p>:CURR:PROT? Inquires about the set OCP value of a single channel model. :CURR:PROT:A? Inquires about the set OCP value of CH1. :CURR:PROT:B? Inquires about the set OCP value of CH2.</p>
Response example	<p>10.10 Indicates that the set OCP value is 10.10A.</p>
Remark	<p>When the tracking mode is on, setting CH1 will affect CH2. Setting CH2 in the tracking mode will cause an execution error.</p>

Output power setting (:POW)

This command sets or inquires about the output power.

Setting	<p>:POW <value> Sets the output power of a single channel model. :POW:A <value> Sets the output power of CH1. :POW:B <value> Sets the output power of CH2. The <value> range in single-unit operation is as shown below: PSB-2400L, PSB-2400L2, PSB-2400H: 10 to 410 PSB-2800L, PSB-2800H: 10 to 820 Integers are valid. The setting range changes when the power supplies are used in parallel. Setting range: 0.0 to (total power x 1.025)</p>
Application example	<p>:POW 100 Sets the output power of a single channel model to 100W.</p>
Query	<p>:POW?</p>

	<p>Inquires about the set output power of a single channel model. :POW:A? Inquires about the set output power of CH1. :POW:B? Inquires about the set output power of CH2.</p>
Response example	<p>100 Indicates that the set output power is 100W.</p>
Remark	<p>When the tracking mode is on, setting CH1 will affect CH2. Setting CH2 in the tracking mode will cause an execution error.</p>

OUTPUT ON/OFF (:OUTP)

This command turns on or off output.

Setting	<p>:OUTP <value> Sets the output of a single channel model. :OUTP:A <value> Sets the output of CH1. :OUTP:B <value> Sets the output of CH2. The relationship between <value> and On/Off is as shown below: 1: Output On, 0: Output Off On the dual channel model, :OUTP selects the OUTPUT. The output is activated only after <value> is set to 1.</p>
Application example	<p>:OUTP 1 Activates output.</p>
Query	<p>:OUTP? Inquires about the output setting of a single channel model. :OUTP:A? Inquires about the output setting of CH1. :OUTP:B? Inquires about the output setting of CH2.</p>
Response example	<p>1 Indicates that the output is activated. The return values of the query have the same meaning as the setting <value>.</p>
Remark	<p>This command causes an execution error if the output is externally controlled. Sending the :OUTP command causes a command error when both channels of the dual channel model are deactivated.</p>

Hi- Ω ON/OFF (:CONF:HIZ)

This command turns on or off the Hi- Ω function. Only applicable to the PSB-L series only.

Setting	:CONF:HIZ <value> <value> is as shown below: 1: Hi- Ω On 0: Hi- Ω Off
Application example	:CONF:HIZ 1 Activates the Hi- Ω function.
Query	:CONF:HIZ? Inquires about the setting.
Response example	1 Indicates that the Hi- Ω function is working. The return values of the query have the same function as the setting <value>.
Remark	None

Hi- Ω Time Setting (:CONF:HIZ:HOLD)

This command sets the Hi- Ω function holding time in minutes. This function only applies to the PSB-L series.

Setting	:CONF:HIZ:HOLD <value> <value> is set in 5 steps between 5 and 30. Any value not ending with 0 or 5 is rounded off.
Application example	:CONF:HIZ:HOLD20 Sets the Hi- Ω holding time to 20 minutes.
Query	:CONF:HIZ:HOLD? Inquires about the setting.
Response example	5 Indicates that the Hi- Ω holding time is five minutes. The return values of the query have the same function as the setting <value>.
Remark	None

Display Switching (:CONF:DISP)

This command switches the voltage, current and power display modes.

Setting	:CONF:DISP <value>
---------	--------------------

	<p><value> is as shown below: 1: CH1 voltage + current display 2: CH1 voltage + power display 3: CH1 power + current display 4: CH2 voltage + current display 5: CH2 voltage + power display 6: CH2 power + current display 7: Sequence or Off Timer display For a single channel model, use the values 1 to 3 or 7 to specify a display mode.</p>
Application example	:CONF:DISP 1 Selects the voltage + current display mode.
Query	:CONF:DISP? Inquires about the display setting.
Response example	1 Indicates that the voltage + current display mode is selected. The return values of the query have the same meaning as the setting <value>.
Remark	A value between 4 and 6 causes an error if it is set for a single channel model (single channel models don't have CH2). The value of 7 causes an error unless the Off Timer or sequence function (Pause, RUN) is turned on.

Tracking ON/OFF (:CONF:TRAC)

This command turns on or off the tracking function. Applicable for the PSB-2400L2 only.

Setting	:CONF:TRAC <value> <value> is as shown below: 0: Off 1: On
Application example	:CONF:TRAC 1 Activates the tracking function.
Query	:CONF:TRAC? Inquires about the setting status.
Response example	1 Indicates that the tracking function is working. The query return has the same meaning as the setting <value>.
Remark	This command causes an error if it is set for a single channel model or if a sequence operation is running.

External Control Setting (:EXT:MOD)

This command sets the external control mode.

Setting	:EXT:MOD <value> <value> is as shown below: 0: Settings are controlled from the front panel or via remote control. 1: External voltage control 2: External resistance control
Application example	:EXT:MOD 1 Selects the external voltage control.
Query	:EXT:MOD? Inquires about the setting status.
Response example	1 Indicates that external voltage control has been enabled. The query return has the same meaning as the setting <value>.
Remark	This command causes an error if a sequence operation is running.

External Control of the Voltage Output ON/OFF (:EXT:VOLT)

This command chooses whether the external control is used to control the output voltage or if the front panel controls are used to control the output voltage.

Setting	:EXT:VOLT <value> Activates or deactivates external control of the output voltage of a single channel model.
	:EXT:VOLT:A <value> Activates or deactivates external control of the output voltage of CH1. :EXT:VOLT:B <value> Activates or deactivates external control of the voltage output of CH2. <value> is as shown below: 0: Deactivates external control of the voltage output (Allows the voltage output to be controlled from the front panel or from remote control). 1: Activates external control of the voltage output.
Application example	:EXT:VOLT 1 Selects external control of the voltage output.
Query	:EXT:VOLT?

	Inquires about the setting.
Response example	1 Indicates that external control of the voltage output is enabled. The query return value has the same meaning as the setting <value>.
Remark	This command causes an error if the sequence function is running.

External Control of the Current Output ON/OFF (:EXT:CURRE)

This command chooses whether the external control is used to control the output current or if the front panel controls are used to control the output current.

Setting	:EXT:CURRE <value> Activates or deactivates external control of the output current of a single channel model. :EXT:CURRE:A <value> Activates or deactivates external control of the output current of CH1. :EXT:CURRE:B <value> Activates or deactivates external control of the output current of CH2. <value> is as shown below: 0: Deactivates external control of the output current (Allows the current output to be controlled with the front panel controls or via remote control). 1: Activates external control of the current output.
Application example	:EXT:CURRE 1 Selects the external control of the current output.
Query	:EXT:CURRE? Inquires about the setting.
Response example	1 Indicates that external control of the current output is enabled. The query return value has the same meaning as the setting <value>.
Remark	This command causes an error during sequence operation (RUN).

Output switching (:EXT:OUTP)

This command selects output On/Off with external contacts.

Setting	:EXT:OUTP <value> <value> is as shown below: 0: Control from the panel or through communication 1: Output On/Off with external contacts
Application example	:EXT:OUTP 1 Selects output On/Off with external contacts.
Query	:EXT:OUTP? Inquires about the setting.

Response example	1 Indicates that output On/Off with external contacts is working. The query return value has the same meaning as the setting <value>.
Remark	This command causes an error if the sequence function is running.

Off Timer ON/OFF (:TIMER:MOD)

This command activates or deactivates the Off Timer.

Setting	:TIMER:MOD <value> <value> is as shown below: 0: Deactivates the Off Timer. 1: Activates the Off Timer.
Application example	:TIMER:MOD 1 Activates the Off Timer.
Query	:TIMER:MOD? Inquires about the setting.
Response example	1 Indicates that the Off Timer is activated. The query return value has the same meaning as the setting <value>.
Remark	This command causes an error if the sequence function is running.

Off Timer Value Setting (:TIMER:SET)

This command sets or inquires what the value of the Off Timer setting is.

Setting	:TIMER:SET <value> The <value> range is between 0.1 and 99.5. Specify the hour in the integer part and the minutes in the first decimal place (In units of 10 minutes).
Application example	:TIMER:SET 10.3 Set the Off Timer value to 10 hours and 30 minutes.
Query	:TIMER:SET? Inquires about the setting.
Response example	15.2 Indicates that the Off Timer value is set to 15 hours and 20 minutes.
Remark	This command causes an error if the sequence function is running. It also causes an error if a value between 6 and 9 is set in the first decimal place (I.e, a value of greater the 60 minutes).

Delay Function ON/OFF (:DELAY:MOD)

This command activates or deactivates the delay function. This function only applies to the PSB-2400L2.

Setting	:DELAY:MOD <value> <value> is as shown below: 0: Deactivates the delay function. (Normal) 1: Activates the delay function.
Application example	:DELAY:MOD 1 Activates the delay function.
Query	:DELAY:MOD? Inquires about the setting.
Response example	1 Indicates that the delay function is working. The query return value has the same meaning as the setting <value>.
Remark	This command causes an error if the sequence function is running.

Delay Rise Time Setting (:DELAY:RISE)

This command sets or inquires about the delay time for turning on the output. This function only applies to the PSB-2400L2.

Setting	:DELAY:RISE <value> The <value> range is from -9.99 to +10.00 seconds.
Application example	:DELAY:RISE 0.3 Sets the delay time for turning on the output to 0.3 seconds.
Query	:DELAY:RISE? Inquires about the setting.
Response example	0.3 Indicates that the delay time for turning on the output is set to 0.3 seconds.
Remark	This command causes an error if the sequence function is running.

Delay Fall Time Setting (:DELAY:FALL)

This command sets or inquires about the delay time for turning off output.

Setting	:DELAY:FALL <value> The <value> range is from -9.99 to +10.00 seconds.
Application example	:DELAY:FALL 0.3 Sets the delay time for turning off output to 0.3 second.
Query	:DELAY:FALL? Inquires about the setting.
Response example	0.3 Indicates that the delay time for turning off output is set to 0.3 seconds.
Remark	This command causes an error if the sequence function is running.

Monitor Inquiry (:MEAS?)

This command inquires about the monitored data. In response, the voltage, current, power and CV/CC/CP status are returned, in that order.

Setting	None
Query	:MEAS? Inquires about the monitored data of the single channel model. :MEAS:A? Inquires about the monitored data of CH1. :MEAS:B? Inquires about the monitored data of CH2.
Response example	20.00,5.00,100,0 Indicates that the output values are 20.00V, 5.00A and 100W and the CV function is working. The voltage, current, power and status are returned in this order. The status of the protection functions are: 0 (CV), 1 (CC) or 2 (CP).
Remark	None

Preset Recall (:PRES:CALL)

This command recalls and inquires about preset data.

Setting	:PRES:CALL <value> <value> is as shown below: 0: Cancels preset. 1: Calls PRESET 1 data. 2: Calls PRESET 2 data. 3: Calls PRESET 3 data.
Application example	:PRES:CALL1 Recalls the set values stored in PRESET 1.
Query	:PRES:CALL? Inquires about the setting.
Response example	1 Indicates that PRESET 1 is selected. The query return value has the same meaning as the setting <value>.
Remark	This command causes an error if the sequence function is running.

Preset Saving (:PRES:SAVE)

This command saves the current set values (voltage, current and power) in PRESET memory.

Setting	:PRES:SAVE <value> <value> is as shown below: 1: Saves the current set value in PRESET 1. 2: Saves the current set value in PRESET 2. 3: Saves the current set value in PRESET 3.
Application example	:PRES:SAVE1 Saves the current set values in PRESET 1.
Query	None
Remark	This command causes an error if the sequence function is running.

Sequence Mode Setting (:SEQ:MOD)

This command controls a sequence operation. It can start, stop or pause a sequence.

Setting	:SEQ:MOD <value> <value> is as shown below: 0: Stops sequence operation. 1: Pause sequence operation – Waits for start. 2: Runs sequence operation (Executes sequence).
Application example	:SEQ:MOD 2 Runs the sequence.
Query	:SEQ:MOD? Inquires about the setting.
Response example	2 Indicates that sequence operation is being executed. This command causes an error if the sequence function is running.
Remark	None

Sequence Jump Setting (:SEQ:STEP)

This command jumps to a specified step in the sequence operation.

Setting	:SEQ:STEP <value> The <value> range is from 0 to 99. This command can only be executed when a sequence is paused.
Application example	:SEQ:STEP 2 Jumps to step 2.
Query	:SEQ:STEP? Inquires about the setting.
Response example	2,1 Indicates that step 2 is selected and the repetition frequency is 1 (looped one time).
Remark	This command causes an error if the sequence function is running.

Sequence Start Step Setting (:SEQ:START)

This command specifies which step to start from when running a sequence.

Setting	:SEQ:START<value> The <value> range is from 0 to 99.
Application example	:SEQ:START2 Sets the sequence to start from step no. 2.
Query	:SEQ:START? Inquires about the setting.
Response example	2 Indicates that the sequence starts from step 2.
Remark	None

Sequencer End Step Setting (:SEQ:END)

This command specifies which step to end the sequence on.

Setting	:SEQ:END<value> The <value> range is from 0 to 99.
Application example	:SEQ:END2 Sets the sequence to end at step no. 2.
Query	:SEQ:END? Inquires about the setting.
Response example	2 Indicates that the sequence ends at step no. 2.
Remark	None

Sequence Repetition Frequency Setting (:SEQ:CYCL)

This command specifies the number of times the sequence is looped(repetition frequency).

Setting	:SEQ:YCL<value> The <value> range is from 0 to 999. When set to 0, the sequence is repeated endlessly (infinite loops).
Application example	:SEQ:CYCL 2 Sets the sequence to loop 2 times.
Query	:SEQ:CYCL? Inquires about the setting.
Response example	2 Indicates that the sequence is looped twice.

Remark	None
--------	------

Sequence Data Transfer (:SEQ:DOWNLOAD)

This command transfers the sequence set data.

Setting	:SEQ:DOWNLOAD<value> <value> represents 1609-byte binary sequence set data.
Application example	:SE:DOWNLOAD#6001600..... LF Transfers an 8-byte header for the binary data, 1600-bytes of actual data, and a 1 byte for the delimiter (total: 1609 bytes).
Query	:SEQ:DOWNLOAD? Requests the sequence data.
Response example	#6001600..... LF 1609-byte sequence set data are returned.
Remark	PSB_Sequence_203 software is available. Use it for setting ¹

¹ The application software for sequence operation may be downloaded from the GW Instek website.

Model Inquiry (*IDN?)

This command returns the company name, model name, serial number and version number.

Setting	None. Query only.
Query	*IDN? The company name, model name, serial number and version are returned in this order.
Response example	GW Instek,PSB-2400L,0,1.00/1.00

Standard Event Status Register Inquiry (*ESR?)

The function of this command is described in the “Standard Event Status Register” in the following section.

Standard Event Status Enable Register Setting (*ESE)

The function of this command is described in “Standard Event Status Enable register” in the following section.

Status Byte Inquiry (*STB?)

The function of this command is described in “Status Byte Register” in the following section.

SRQ (Service Request) Register Setting (*SRE)

The function of this command is described in “Service Request Register” in the following section.

Buffer Clear (*CLS)

This command clears the buffers.

Setting	*CLS Clears the send buffer, receive buffer, local bus buffer, command execution buffer, status byte and event register.
Query	None

Communication Reset (*RST)

This command clears the communication status.

Setting	*RST Clears the send buffer, receive buffer, local bus buffer, command execution buffer, status byte and event register. Clears the ESE register and SRE register and also clears the talker and listener settings.
Query	None

Command Completion (*OPC)

This command sets bit 0 of the standard event status register (ESR) when all current overlapped commands have been processed.

Setting	*OPC Sets bit 0 of the ESR when all current overlapped commands are complete. A SRQ is generated depending on the status of the ESE register and SRE register.
Query	*OPC? The value "1" is returned when all current commands are completed.

Wait for Completion (*WAI)

This command waits for command completion.

Setting	*WAI Prevents new commands/queries from being executed until all outstanding overlapped commands have completed.
Query	None

Local Address Setting (:ADDR)

This command specifies the address of a slave unit on the local bus.

Setting	:ADDR <value> The <value> range is from 1 to 30. Specifies the address of a slave on the local bus to be controlled. This command causes no error even if an out-of-range System Address is specified.
Application example	:ADDR3 Sets the System Address of the power supply (slave) to 3. :ADDR1 Sets the System Address of the power supply to 1. A System Address of 1 means that the unit is also set as a master unit.
Query	None
Remark	The default setting is 1 (master unit). Reset <value> to 1 after completion of communication with the local bus.

Remote/Local Setting (:REMOTE)

This command sets or inquires about the remote/local status.

Setting	:REMOTE <value> <value> is as shown below: 0: Local status (Normal manual operation) 1: Remote status 2: Local lockout remote status (Cannot return to the local status through key operation.)
Application example	:REMOTE0 Sets the unit to local status.
Query	:REMOTE?
Response example	1 Indicates that the unit is in the remote status. The query return value has the same meaning as the setting <value>.
Remark	If this query is sent when the unit is in the local status, a response is made after the unit enters the remote status. Thus, 1 is returned.

Registers

Introduction

The PSB power supply unit has registers that conform to the status reporting specified in IEEE488.2.

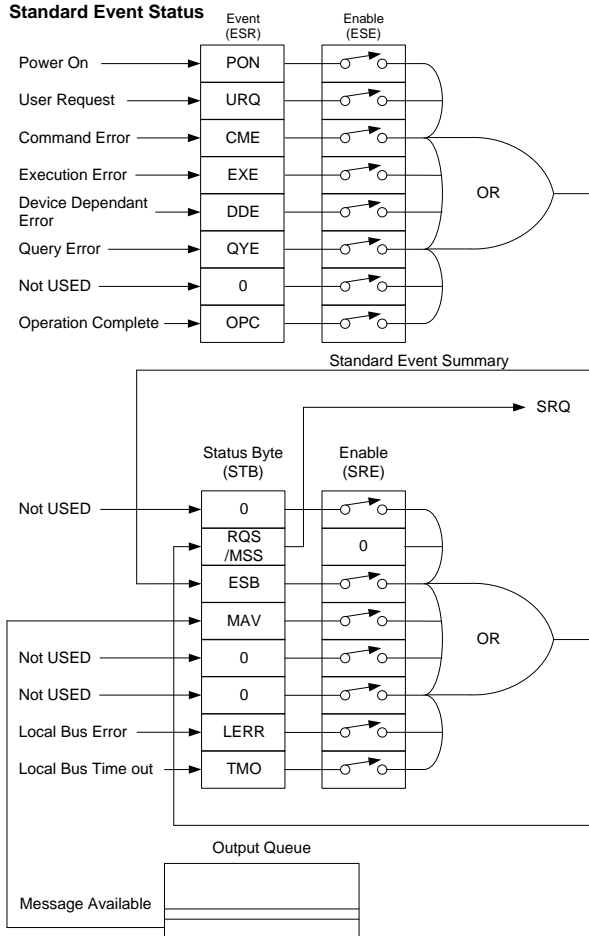

Status Byte Register (STB, SRE)

Bit	Data	Item	Description	Initial STB value	Initial SRE value
7	128	0	Unused.	0	0
6	64	SRQ RQS MSS	Service request Message summary	0	0
5	32	ESB	Standard event summary	0	0
4	16	MAV	Output message available	0	0
3	8	0	Unused.	0	0
2	4	0	Unused.	0	0
1	2	LERR	Local bus error	0	0
0	1	TMO	Local bus Time out	0	0

Summary Each bit is masked when it is set to “0”. (0 is the default setting.) A bit is not longer masked when it is set to 1. Unused bits are set to “0”.

Item	Description	
SRQ RQS MSS	The MSS bit is the summary bit for the status byte register. The MSS bit is set to 1 when the Boolean AND of the bits in the status byte register and the bits in the service request enable register equals 1. The RQS bit is set to 1 when the MSS bit changes from 0 to 1. The RQS bit is cleared when the MSS bit is cleared or serial polling is used.	
ESB	Indicates that an event occurs in the standard event status register.	
MAV	Indicates that there is a message in the output queue.	
*SRE?	Sets or inquires about the service request enable register.	
	Setting command	*SRE <value> The <value> range is from 0 to 255.
	Application example	*SRE 48

		Enables the MAV and ESB bits since the value of 48 (→ 00110000 in binary) sets bit 4(MAV) and 5(ESB).
	Query command	*SRE?
	Response example	48 The masking value set with this command remains valid until the setting is changed or the power is turned off. All bits are masked (0) when the power is turned on, regardless of the previous setting.
*STB?	Returns the status byte register and MSS.	
	Setting command	None. Query only.
	Query command	*STB?
	Response example	32 The bits set with the *SRE command are only returned in decimal. The status byte register is not cleared even if a query is made using this command.

Standard Event Register (ESR, ESE)

Introduction The standard event register is controlled with the *ESE, *ESE? and *ESR? commands/queries.

Bit	Data	Item	Description	Initial ESR value	Initial ESE value
7	128	PON	Power On flag	1 (Power ON)	0
6	64	-	Unused.	0	0
5	32	CME	Command error	0	0
4	16	EXE	Execution error	0	0
3	8	ALM	Alarm occurrence	0	0
2	4	-	Unused.	0	0
1	2	-	Unused.	0	0
0	1	OPC	Operation complete	0	0

Item	Description	
*ESE	Sets or inquires about the standard event status enable register.	
	Setting command	*ESE<value> The <value> range is from 0 to 255.
	Application example	*ESE 48 Enables the CME (bit 5) and EXE (bit 4) of the Event Status register.
	Query command	*ESE?
	Response example	48 The masking set with this command remains valid until the setting is changed or power is turned off. All bits are masked (0) when power is turned on, regardless of the previous setting.
*ESR?	Inquires about the Standard Event Status register.	
	Setting command	None. Query only.
	Query command	*ESR?
	Response example	32 Bit 5 is set indicating that a command error has occurred. The ESR is cleared after reading the value.

Function of the Status Byte Register

Introduction If some event occurs and some bits of the status byte register are set to 1, bit 6 is set to 1 and a service request (SRQ) is issued. Four status bits shown below may possibly be the causes of an SRQ in the PSB 2000 series power supply unit.

If an execution error occurs, bit 4 of the standard event status register (ESR) is set to 1. When the boolean AND of the bits in the ESR and the ESE equals 1, bit 5 (ESB) of the status byte register is set to 1. If bit 5 of the service request enable register

(SRE) is set 1 at this time, bit 6 (MSS) of the status byte register is set to 1 and a service request (SRQ) is generated.

Bit 5	ESB	Standard event status register summary
Bit 4	MAV	Message available
Bit 1	LERR	Local bus execution error
Bit 0	TMO	Local bus time-out



NOTE

An SRQ is issued through the GPIB interface only.

Reading Data from the Status Byte Register and Clearing the Status Byte Register

Introduction The content of the status byte register may be read out from the controller in the following two ways:

- Executing the the *STB? query.
When the *STB? query is executed the status of the MSS bit is returned. No bits of the status byte are cleared after reading it.
- Serial polling.
When serial polling is executed, the status of the RQS bit (bit 6) is returned. The RQS bit is only cleared after reading it. It is impossible to read the MSS bit. It is impossible to clear the status byte register directly; to clear the status byte register, you must first clear the associated event registers that cause the bits of the status byte register to be set.
- When ESB occurs.
When an inquiry is made with the *ESR? query, the data from the standard event register are read and all the bits are cleared.
- When the *CLS command is received.

When receiving the *CLS command, the PSB 2000 series power supply unit clears the standard event register and the status byte register.

- When MAV occurs.
The MAV bit is cleared when all the data is read out from the output queue.

The output queue is not cleared by the *CLS command.

When the event register and MAV are cleared completely, MSS in bit 6 is also cleared.

Clear and Reset Statuses

Introduction	It is possible to cause clearing or resetting in the PSB 2000 Series power supply unit by issuing commands or executing specific operations.
IFC (Interface clear)	<p>Responses to the universal command, IFC, are as shown below:</p> <ul style="list-style-type: none"> • The specified talker or listener status is cleared. • The GPIB buffer, output queue and input queued commands command remain unchanged. • The SRQ remains unchanged. • The remote status and LLO (local lock out) setting remain unchanged. • Panel setting remains unchanged.
DCL SDC (Device clear)	Responses to the universal command, DCL, and the address command, SDC, are as shown below:

- The GPIB buffer, output queue and input queued commands are cleared.
- The interface status (specified talker or listener status) is cleared.
- The SRQ and status byte register are cleared.
- The remote status and LLO (local lock out) setting are cleared and the power supply unit enters the local state.
- Panel setting remains unchanged.

*RST
(Reset
command)

Responses to the IEEE488.2 command, *RST, are as shown below:

- The specified talker or listener status is cleared.
 - The GPIB buffer, output queue and input queued commands are cleared.
 - The SRQ, status byte register and mask settings are cleared.
 - The remote status and LLO (local lock out) setting remain unchanged.
 - Panel setting remains unchanged.
-

Turning on power again When power is turned on again, the statuses are as shown below:

- The specified talker or listener status is cleared.
- The GPIB buffer, output queue and input queued commands are cleared.
- The SRQ, status byte register and mask settings are cleared.
- The unit enters the local status. The LLO (local lock out) set before turning off power is cleared.
- Panel setting at the time when power is turned off remains unchanged.

Remote/Local Function

Introduction The remote/local function is controlled by the system controller and with the **FAST** key on the PSB 2000 series power supply unit. (This key serves as the FAST, LOCK and LOCAL keys.) The PSB 2000 series power supply unit always resides in the local, remote, or remote with local lockout state.

Local The PSB 2000 series power supply unit enters the local status in either of the following cases:

- When power is turned on.
- When the **FAST** key is pressed and the LED on the side of the key is lit.
- When the unit receives the GTL command.
- When the remote status is canceled.

Remote The PSB 2000 Series power supply unit enters the remote status when it is specified as the listener in the condition where REN is true. The LED display goes into the remote display mode, where any panel keys other than the POWER switch and **FAST** key are inoperative. In the local lockout state, any keys other than the POWER switch are inoperative, with the only exception to this is if there is an error.

Responses to Multi-Line Message Commands

Introduction The table below shows the types of multi-line message commands and the responses to the commands.

Type	Name	Description	Response
Universal commands	DCL	Clears the GP-IB buffer.	○
	SPE	Establishes the serial polling state.	○
	SPD	Clears serial polling.	○
	PPU	Clears parallel polling.	×
	LLO	Brings all devices into the local lockout status to disable manual operation.	○
Address commands	UNL	Cancel the specified listener status.	○
	UNT	Cancel the specified talker status.	○
	SDC	Clears the GPIB buffer.	○
	PPC	Enables parallel polling line assignment to the specified listener in parallel polling.	×
	GTL	Brings a specified device into the local status.	○
	GET	Triggers a specified device.	×
	TCT	Transfers the controller.	×

APPENDIX

Trouble Shooting

Overview This section shows some possible problems that may arise and the solutions to some of these problems.

Most problems may be solved by rechecking connections, settings or some other simple solution. Contact your nearest distributor if problems are not eliminated or improved using the trouble shooting guide. Never open the case to check the inside.

Problem	Possible Cause	Check and Counter Measures
Power is not turned on, even after pressing the POWER switch.	• AC power cable is broken or has poor contact.	• Check connection or replace the cable.
	• Input fuse has blown.	• Input voltage is out of the allowable range.
“----“ is displayed after starting operation.	The unit is specified as a slave unit.	Specify the unit as the master unit. See page 70, “Master/slave function”.
“OHP” is displayed after starting operation.	The OHP function works.	Check the ambient temperature, air intake and exhaust ports and dust filter.
Display disappears in short time after starting operation.	The fan is stopping.	Check the fan.
No output is given even when the OUTPUT key is pressed.	• The set voltage is “0V”.	• See page 42, “How to set voltage” . See page 78, “Constant-voltage control with external voltage or resistance”.
	• The set current is “0A”. (In the CC status)	• See page 43, “How to set current”. See page 80, “Constant-

		current control with external voltage or resistance.”
	• On/Off with the external contacts is selected.	• See page 81, “Output On/Off with external contacts”.
	• The channel output key is not selected or an incorrect channel is selected for output.	• See page 44, “How to output”.
	• Keys are locked.	• See page 48, “How to disable panel operations”.
“OVP” is displayed when the OUTPUT key is pressed.	• The OVP value is too low.	• See page 53, “OVP/OCP function”.
	• The sensing wire(s) is/are disconnected.	• See page 73, “Voltage Remote Sensing”.
	• The resistor is open in the external resistance control mode.	• See page 78, “Constant-voltage control with external voltage or resistance”.
“OCP” is displayed when the OUTPUT key is pressed.	• The OCP value is too low.	See page 53, “OVP/OCP function”.
Cannot raise the current up to the set current value.	CP (constant-power) operation is being used, or the CP value is too low.	See page 43, “How to set power”.
Output is unstable.	Oscillating due to influences of the load.	• Twist the load or sensing wires, or change the wire layout. • Connect a capacitor at the output end of the power source or the load end.
Output voltage does not fall.	The Hi-Ω function is activated.	See page 55, “Hi-Ω function”.

Maintenance

Introduction The PSB Series power supply unit employs a fan for forced cooling.

Clean the dust filter inside the front grill periodically to maintain the cooling efficiency. Pull the front grill while pressing the notch in the upper part to detach the grill. Clean the filter with water. Before you remove the grill, turn off the POWER switch and disconnect the AC power cable to turn off the unit.

 **CAUTION** Dry the filter completely before re-attaching it. Any water remaining in the filter may cause problems.

- PSB-2400L
- PSB-2400L2
- PSB-2800L
- PSB-2400H
- PSB-2800H

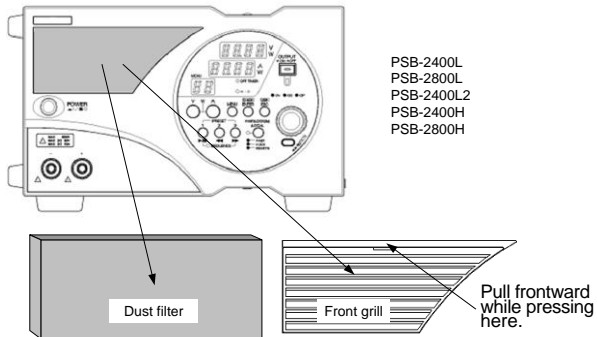

PSB-2800LS

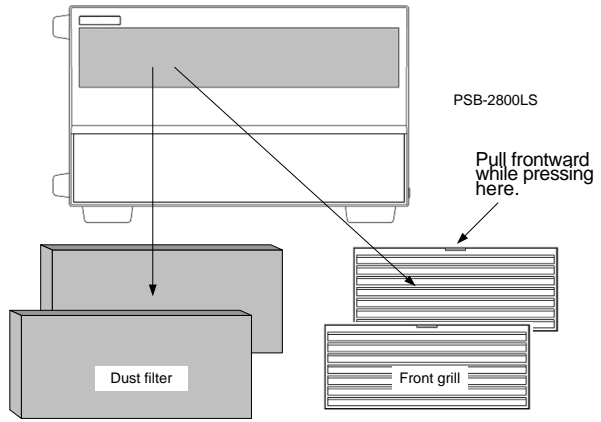

Dimensions

PSB--2400L, PSB-2400L2, PSB-2800L

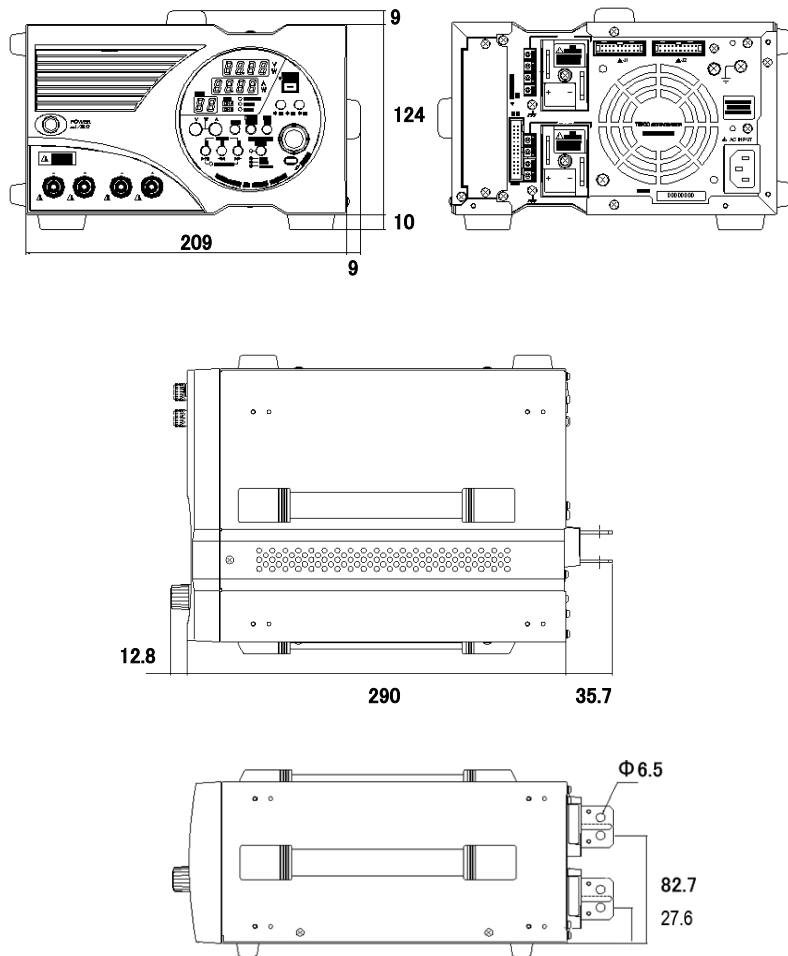

PSB-2800LS

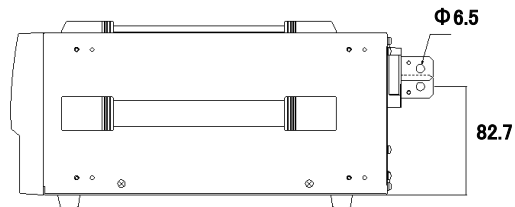
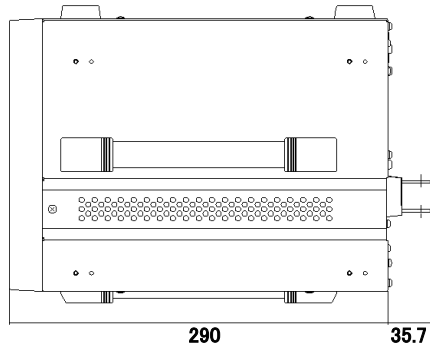
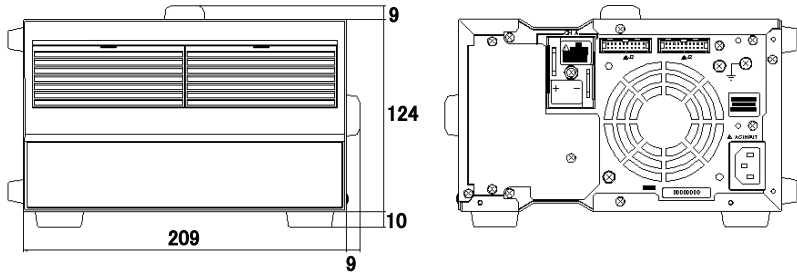

PSB-2400H, PSB-2800H

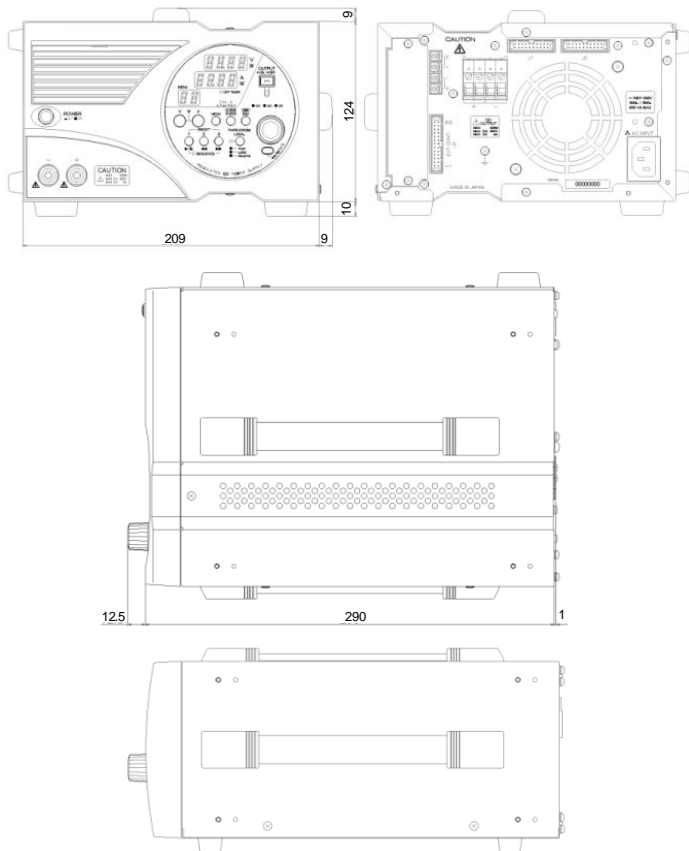

Specifications

Output

Model	PSB-2400L	PSB-2800L	PSB-2400L2	PSB-2800LS
Rated output voltage	80.00V	80.00V	80.00V×2CH	80.00V
Setting accuracy	0.1% setting ±2 digit (23°C ±5°C)			
Resolution	10mV			
Display accuracy	0.2% reading ±2 digit (23°C ±5°C)			
Rated output current ¹	40.00A	80.00A	40.00A×2CH	80.00A
Setting accuracy	0.2% setting ±2 digit (23°C ±5°C)			
Resolution	10mA			
Display accuracy	0.3% reading ±2 digit (23°C ±5°C)			
Rated output power ²	400W	800W	400W×2CH	800W
Setting accuracy	±10W			
Resolution	10W			
Display accuracy	0.5% reading ±5 digit (23°C ±5°C)			

¹ The maximum output current through the front output terminals is 40A.

² Switching from the constant-voltage (CV) or constant-current (CC) mode into the constant-power (CP) mode or vice versa is subject to over-shoot ringing, etc.

Model	PSB-2400H	PSB-2800H
Rated output voltage	800.0V	
Setting accuracy	0.1% setting ±2 digit (23°C ±5°C)	
Resolution	100mV	
Display accuracy	0.2% reading ±2 digit (23°C ±5°C)	
Rated output current ¹	3.00A	6.00A
Setting accuracy	0.2% setting ±2 digit (23°C ±5°C)	
Resolution	10mA	
Display accuracy	0.3% reading ±2 digit (23°C ±5°C)	
Rated output power ²	400W	800W
Setting accuracy	±10W	
Resolution	Output voltage should be at least 1% of the rated voltage	
Display accuracy	10W	
Display accuracy	0.5% reading ±5digit (23°C ±5°C)	

¹ The maximum output current through the front output terminals is 3A(2400H) or 6A(2800H).

² Switching from the constant-voltage (CV) or constant-current (CC) mode into the constant-power (CP) mode or vice versa is subject to over-shoot ringing, etc.

Input

Model	PSB-2400L, PSB-2400H	PSB-2800L, PSB-2400L2, PSB-2800LS, PSB-2800H
Input voltage	AC100V to 240V, single-phase, frequency: 50Hz or 60Hz	
Power consumption ³	560VA	1120VA
Power factor ⁴		0.99
Rush current	35A max.	70A max.

^{3,4} At the rated output voltage and AC100V input

Constant-Voltage Characteristics

Model	PSB-2400L	PSB-2800L	PSB-2400L2
Source fluctuation ⁵	0.01% ±2mV of rated voltage		
Load fluctuation ⁶	0.01% ±3mV of rated voltage		
Ripple noise (p-p) ⁷	90mV	150mV	90mV
Ripple noise (rms) ⁸	4mV	6mV	4mV
Transient response (typ.) ⁹	1ms	1ms	1ms
Rise time (typ.) ¹⁰	50ms (rated load), 50ms (no load)		
Fall time (typ.) ¹¹	100ms (rated load), 500ms (no load)		
Temperature coefficient (typ.) ¹²	±50ppm/°C (after 30-minute warming up)		

Model	PSB-2400H	PSB-2800H
Source fluctuation ⁵	0.01% ±20mV of rated voltage	
Load fluctuation ⁶	0.01% ±30mV of rated voltage	
Ripple noise (p-p) ⁷	250mV	300mV
Ripple noise (rms) ⁸	20mV	25mV
	(When current is 2A or lower)	
	35mV	40mV
	(When current is higher than 2A)	
Transient response (typ.) ⁹	Output voltage should be at least 1% of the rated voltage	
	7ms	
Rise time (typ.) ¹⁰	200ms (rated load), 200ms (no load)	
Fall time (typ.) ¹¹	500ms (rated load), 1000ms (no load)	
Temperature coefficient (typ.) ¹²	±100ppm/°C (after 30-minute warming up)	

Constant-Current Characteristics

Model	PSB-2400L	PSB-2800L	PSB-2400L2
Source fluctuation ⁵	0.01% ±2mV of rated voltage		
Load fluctuation ¹³	0.01% ±3mV of rated voltage		
Ripple noise (rms)	30mA	60mA	30mA
Temperature coefficient (typ.) ¹²	±100ppm/°C (after 30-minute warming up)		

Model	PSB-2400H	PSB-2800H
Source fluctuation ⁵	0.05% ±10mV of rated voltage	
Load fluctuation ¹³	0.05% ±15mV of rated voltage	
Ripple noise (rms)	15mA	20mA
Temperature coefficient (typ.) ¹²	±200ppm/°C (after 30-minute warming up)	

Constant-Power Characteristics

Model	PSB-2400L, PSB-2800L, PSB-2400L2, PSB-2400H, PSB-2800H
Source fluctuation ⁵	0.5% ±10W

⁵ Fluctuation when the source voltage is changed by ±10% in the range from AC100V to 240V.

⁶ Fluctuation when the load is changed from the rated load into no load (open circuit) at the rated output voltage.

⁷ Measured at the frequency up to 20 MHz.

⁸ Measured at the frequency up to 1 MHz. (300kHz for PSB-2400H, PSB-2800H)

⁹ Response time till the output voltage is restored to the range within 0.1% + 10 mV of the rated output voltage when the output current is changed from 50% to 100% of the maximum output current at the rated output voltage.

¹⁰ Value with a fixed load. Time until the output voltage increases from 10% to 90% of the rated output voltage.

¹¹ Value with a fixed load. Time until the output voltage decreases from 90% to 10% of the rated output voltage.

¹² Value after 30 minutes of warming up (excluding external control).

¹³ Fluctuation when the load is changed from the rated load into no load (short circuit) at the rated output current.

Function

Constant-voltage (CV) control with external voltage	Output voltage: Approx. 0V to rated output voltage For external voltage: 0V to 10V
Constant-voltage (CV) control with external resistance	Output voltage: Approx. 0V to rated output voltage For external resistance: 0Ω to 10KΩ
Constant-current (CC) control with external voltage	Output current: Approx. 0A to rated output current For external voltage: 0V to 10V

Constant-current (CC) control with external resistance	Output current: Approx. 0A to rated output current For external resistance: 0Ω to 10kΩ
External On/Off control	On/Off at contact. Short: On, Open: Off
Output voltage monitor signal	Approx. 0V to 10V for 0V to rated output voltage.
Output current monitor signal	Approx. 0V to 10V for 0A to rated output current.
Constant-voltage (CV) status signal	Open collector, active low.
Constant-current (CC) status signal	Open collector, active low.
Alarm signal output	Open collector, active low.
Alarm signal input	Turns off the output when shorted.
Remote sensing function	Compensates for a voltage drop of up to 1V (single side) within the rated voltage at both ends of the power supply.
Parallel frame link operation	Up to four units (PSB-L series). Up to two units (PSB-H series).
Series frame link operation	Up to two units (PSB-L series).
Preset function	A maximum of three points are presettable.
Off timer (OFF TIMER) function	Time until turning off the output is presettable. Setting range: 10min. to 99hrs. & 50min.
High-impedance (Hi-Ω) function	Turns off the internal bleeder circuit. (For PSB-L series only)
Delay (DELAY) function	Output delay time is presettable. Setting range: -9.99sec to 10.00sec. (Resolution: 0.01sec.) (For PSB-L series only)
Tracking function ¹⁴	May change the output setting of two channels simultaneously.
Key lock function	Disables operations on front panel.
Sequence function	Number of steps: 0 to 99 Step time: 1 to 9999 (sec.) Number of cycles: 1 to 999 (--: Infinite) The product is capable of simple program operations using the PSB_Sequence_203 software. The software for sequence operation may be downloaded from the GW Instek website.

¹⁴ Available on the PSB-2400L2 only.

Protective functions

Over-voltage protection (OVP): Fixed ¹⁵	Stops oscillation when the output voltage exceeds 110% of rated voltage. (Output Off) Presettable range: 1V to 84V on front panel. (PSB-L series)
Over-voltage protection (OVP): Variable ¹⁶	Presettable range: 1V to 840V on front panel. (PSB-H series) Stops oscillation when OVP works. (Output Off)
Over-current protection (OCP): Fixed ¹⁵	Stops oscillation when output current exceeds 110% of rated current. (Output Off) Presettable range: 1A to 42A on front panel. (PSB-L series)
Over-current protection (OCP): Variable ¹⁶	Presettable range: 0.1A to 3.15A on front panel. (2400H) Presettable range: 0.1A to 6.3A on front panel. (2800H) Stops oscillation when OCP works. (Output Off) (2800L: 84A)
Overheat protection (OHP) ¹⁵	When the internal heat sink temperature is over the thermal switch value, the unit will turn off.

¹⁵ Press the POWER switch again to reset.

¹⁶ Press the POWER switch again or press the ESC key to reset.

Others

Cooling method	Forced cooling with fan motor
To-GND voltage	±DC500V (PSB-L series) ±DC100V (PSB-H series)
Dielectric strength voltage	Power In terminals - frame: AC1500V, 1min. Power In terminals - output terminals: AC2300V, 1min. Power In terminals - frame: DC500V (PSB-L), DC1000V (PSB-H), 30MΩ or more.
Insulation resistance	Power In terminals - output terminals: DC500V (PSB-L), DC1000V (PSB-H), 30MΩ or more. (PSB-L) Output terminals - frame: DC500V (PSB-L), DC1000V (PSB-L), 30MΩ or more
Outside dimensions (Projections not included.)	210mm(W)×124mm(H)×290mm(D)
Weight	PSB-2400L, PSB-2400H: Approx. 5kg PSB-2800L, PSB-2400L2, PSB-2800LS: Approx. 7kg PSB-2800H: Approx. 6kg

Environmental Conditions

Operating temperature range	0°C to +40°C
Operating humidity range	30% RH to 80% RH (No dew condensation)
Storage temperature range	-20°C to +70°C
Storage humidity range	30% RH to 80% RH (No dew condensation)

Applicable Standards

LVD		EN61010-1 2nd edition (2001)
		Indoor use
		Altitude up to 2000m
		Transient overvoltage: Overvoltage category II
		Pollution Degree 2
EMC		EN61000-3-2 clause 7.1 class A
		EN61000-3-3 clause 5
	EMS (Min)	EN61326-1 : 2006
	EMI(Class A)	EN61326-1 : 2006

- ❖ The standards are applicable for the product marked CE on the rear panel only and not for modified products.

Default Settings and Storage after Power Off

Item	Initial setting	Storage after power off
Voltage	0.00V	○
Current	0.00A	○
Power	410W/820W	○
OVP	84.00V(PSB-L series)	○
	840.0V(PSB-H series)	○
OCP	42.00A/84.00A(PSB-L series)	○
	3.15A/6.30A (PSB-H series)	○
Display mode	CH1(V/A)	○
Menu display	Initialized when power is turned off.	×
Operation mode	V	○
External voltage control	OFF	○
External resistance control	OFF	○
External output on/off	IN	○
Preset function	OFF	○
Preset item: Voltage	0V	○
Preset item: Current	0A	○
Preset item: Power	410W/820W	○
Off-timer function	OFF	○
High-impedance function	OFF	○
High-impedance holding time	30min	○
Delay function	OFF	○
Trailing delay time	0	○
Falling delay time	0	○
Tracking function	OFF	○
Sequence function	OFF	○
Sequence start No.	0	○
Sequence end No.	99	○
Sequence repetition frequency	1	○
Sequence item: Voltage	0V	○
Sequence item: Current	41.00A/82.00A(PSB-L series)	○
	3.07A/6.15A (PSB-H series)	○

Sequence item: Power	410W/820W	O
Sequence item: Output	OFF	O
Sequence item: Time	1sec	O
Key lock function	OFF	x
One-control operation	OFF	O
Output status	Initialized when power is turned off.	x
Sequence operation status	x(Stop status)	x
Off-timer operation status	x(Non operating status)	x
System Address	1	O
Personal Computer Address	3	O

Parallel/Serial Operation Setting Table

PSB-2400H

Item		Single	Parallel
		400H	400H x 2
		400W	800W
Voltage Setting	SLOW	100mV	
	FAST	10V	
	Range	0V to 820V	
	Min. display digit	100mV	
Current Setting	SLOW	10mA	100mA
	FAST	1A	1A
	Range	0A to 3.07A	0A to 6.1A
	Min. display digit	10mA	
Power Setting	SLOW	10W	20W
	FAST	100W	200W
	Range	10W to 410W	20W to 820W
	Min. display digit	1W	
OVP Setting	SLOW	1V	
	FAST	100V	
	Range	10V to 840V	
	Min. display digit	100mV	
	SLOW	10mA	20mA
	FAST	1A	2A
	Range	0.1A to 3.15A	0.2A to 6.3A
	Min. display digit	10mA	10mA

For parallel connections, the smallest value that can be displayed (Min. display digit) for current is 100mA. When some model combinations are used in parallel, the actual current setting resolution may be different to the display resolution. In this situation the display may not update with only one click of the encoder.

PSB-2800H

Item		Single	Parallel
			800H
		800W	1600W
Voltage Setting	SLOW	100mV	
	FAST	10V	
	Range	0V to 820V	
	Min. display digit	100mV	
Current Setting	SLOW	10mA	100mA
	FAST	1A	1A
	Range	0A to 6.15A	0A to 12.3A
	Min. display digit	10mA	100mA
Power Setting	SLOW	10W	20W
	FAST	100W	200W
	Range	10W to 820W	20W to 1640W
	Min. display digit	1W	
OVP Setting	SLOW	1V	
	FAST	100V	
	Range	10V to 840V	
	Min. display digit	100mV	
	SLOW	10mA	20mA
	FAST	1A	2A
	Range	0.1A to 6.3A	0.2A to 12.6A
	Min. display digit	10mA	10mA

For parallel connections, the smallest value that can be displayed (Min. display digit) for current is 100mA. When some model combinations are used in parallel, the actual current setting resolution may be different to the display resolution. In this situation the display may not update with only one click of the encoder.

PSB-2400L (Part 1/2)

Item	Single	Parallel		
	2400L	2400L x 2	2400L x 3 2400L + 2800L	2400L x 4
	400W	800W	1200W	1600W
Voltage Setting				
SLOW	10mV			
FAST	1V			
Range	0V to 82V			
Min. display digit	10mV			
Current Setting				
SLOW	10mA	100mA	90mA	80mA
FAST	1A	10A	9A	8A
Range	0A-41A	0A-82A	0A-123A	0A-164A
Min. display digit	10mA	100mA		
Power Setting				
SLOW	10W	100W		
FAST	100W	1000W		
Range	10W-410W	20W-820W	30W-1230W	40W-1640W
Min. display digit	1W			
OVP Setting				
SLOW	100mV			
FAST	10V			
Range	1V-84V			
Min. display digit	10mV			
OCP Setting				
SLOW	100mA	200mA	300mA	400mA
FAST	10A	20A	30A	40A
Range	1A-42A	2A-84A	3A-126A	4A-168A
Min. display digit	10mA	100mA		
<p>For parallel connections, the smallest value that can be displayed (Min. display digit) for current is 100mA. When some model combinations are used in parallel, the actual current setting resolution may be different to the display resolution. In this situation the display may not update with only one click of the encoder.</p>				

PSB-2400L (Part 2/2)

Item	Parallel			Series
	2400L+ 2800L x 2	2400L + 2400L + 2800L x 2	2400L + 2800L x 3	2400L + 2400L
	2000W	2400W	2800W	800W
Voltage Setting				
SLOW	10mV			
FAST	1V			
Range	0V to 82V			
Min. display digit	10mV			
Current Setting				
SLOW	100mA	60mA	70mA	10mA
FAST	10A	6A	7A	1A
Range	0A-205A	0A-246A	0A-287A	0A-41A
Min. display digit	100mA			10mA
Power Setting				
SLOW	100W			10W
FAST	1000W			100W
Range	50W-2050W	60W-2460W	70W-2870W	10W-410W
Min. display digit	1W			
OVP Setting				
SLOW	100mV			
FAST	10V			
Range	1V-84V			
Min. display digit	10mV			
OCP Setting				
SLOW	500mA	600mA	700mA	100mA
FAST	50A	60A	70A	10A
Range	5A-210A	6A-252A	7A-294A	1A-42A
Min. display digit	100mA			10mA
<p>For parallel connections, the smallest value that can be displayed (Min. display digit) for current is 100mA. When some model combinations are used in parallel, the actual current setting resolution may be different to the display resolution. In this situation the display may not update with only one click of the encoder.</p>				

PSB-2800L

Item	Single	Parallel			Series	
	800L	800L x 2	800L x 3	800L x 4	800L + 800L	
	800W	1600W	2400W	3200W	1600W	
Voltage Setting						
	SLOW	10mV				
	FAST	1V				
	Range	0V-82V				
	Min. display digit	10mV				
Current Setting						
	SLOW	10mA	100mA	90mA	80mA	10mA
	FAST	1A	10A	9A	8A	1A
	Range	0A-82A	0A-164A	0A-246A	0A-328A	0A-82A
	Min. display digit	10mA	100mA			10mA
Power Setting						
	SLOW	10W	100W			10W
	FAST	100W	1000W			100W
	Range	10W-820W	20W-1640W	30W-2460W	40W-3280W	10W-820W
	Min. display digit	1W				
OVP Setting						
	SLOW	100mV				
	FAST	10V				
	Range	1V-84V				
	Min. display digit	10mV				
OCP Setting						
	SLOW	100mA	200mA	300mA	400mA	100mA
	FAST	10A	20A	30A	40A	10A
	Range	1A-84A	2A-168A	3A-252A	4A-336A	1A-84A
	Min. display digit	10mA	100mA			10mA
<p>For parallel connections, the smallest value that can be displayed (Min. display digit) for current is 100mA. When some model combinations are used in parallel, the actual current setting resolution may be different to the display resolution. In this situation the display may not update with only one click of the encoder.</p>						

Declaration of Conformity

We

GOOD WILL INSTRUMENT CO., LTD.

(1) No.7-1, Jhongsing Rd., Tucheng City, Taipei County, Taiwan

(2) No. 69, Lu San Road, Suzhou City (Xin Qu), Jiangsu Sheng, China

declare, that the below mentioned product

Type of Product: Multi-Range Bench-Top DC Power Supply

Model Number:PSB-2400L, PSB-2800L, PSB-2400L2, PSB-2800LS

are herewith confirmed to comply with the requirements set out in the Council Directive on the Approximation of the Law of Member States relating to Electromagnetic Compatibility (2004/108/EC) and Low Voltage Directive (2006/95/EC).

For the evaluation regarding the Electromagnetic Compatibility and Low Voltage Directive, the following standards were applied:

◎ EMC	
EN 61326-1: Electrical equipment for measurement, control and laboratory use -- EMC requirements (2006)	
Conducted Emission	Electrostatic Discharge
Radiated Emission	IEC 61000-4-2: 2008
CISPR11: 2003+A1: 2004+A2: 2006	Radiated Immunity
Current Harmonics	IEC 61000-4-3: 2008
EN 61000-3-2: 2006+A1:2009+A2:2009	
Voltage Fluctuations	Electrical Fast Transients
EN 61000-3-3: 2008	IEC 61000-4-4: 2004 +A1:2010
-----	Surge Immunity
	IEC 61000-4-5: 2005
-----	Conducted Susceptibility
	IEC 61000-4-6: 2008
-----	Power Frequency Magnetic Field
	IEC 61000-4-8: 2009
-----	Voltage Dip/ Interruption
	IEC 61000-4-11: 2004

◎ Safety

Low Voltage Equipment Directive 2006/95/EC	
Safety Requirements	IEC/EN 61010-1: 2001