

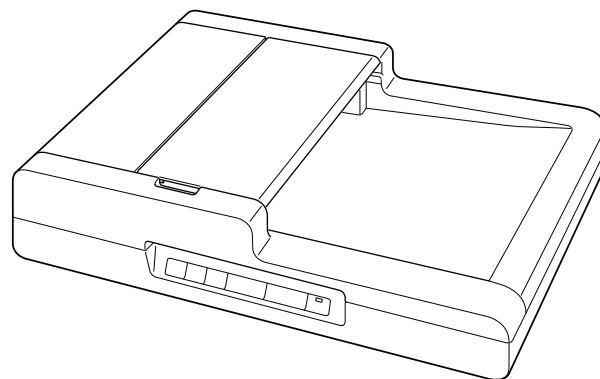

# imageFORMULA DR-F120

## User Manual



Please read this manual before operating this scanner.  
After you finish reading this manual, store it in a safe  
place for future reference.

# Contents

Contents .....	2	Screen Descriptions .....	30
Chapter 1 Introduction .....	4	Standard Scanning .....	31
About This Manual .....	4	Scanning Shortcut .....	33
Features of the Scanner .....	5	Scanning with Start Button .....	36
Names and Functions of Parts .....	6	Operations for the scanned image edit window .....	37
Feeding Methods .....	7	Select document settings .....	40
Regulations .....	8	Setting the output .....	42
Trademarks .....	10	Scanning Shortcut setting .....	43
Chapter 2 Important Safety Instructions .....	11	About file formats .....	43
Installation Location .....	11	Environmental Settings .....	45
AC Adapter .....	12	Chapter 7 Setting the Scanner Driver .....	48
Moving the Scanner .....	12	Configuration and Functions of the Scanner Driver .....	48
Handling .....	12	Setting Basic Scanning Conditions .....	50
Disposal .....	14	Chapter 8 Special Scanning .....	52
When sending the scanner for repairs .....	14	To scan unregistered size documents .....	52
Chapter 3 Installing the Software .....	15	When you want to specify the scan area .....	53
System requirements .....	15	When you want to delete the images of the blank pages in two-sided documents .....	53
Setup Disk Contents .....	16	When you do not want to scan colored lines and text .....	53
Software Installation .....	17	When you want to enhance a particular color .....	54
Chapter 4 Connecting the Scanner .....	19	When you want to enhance contours in images .....	54
Connecting the Scanner to the Computer .....	19	When you want to eliminate black borders around scanned images .....	54
Turning the Power ON .....	20	When you want to make lines or characters in the scanned images thicker .....	54
Chapter 5 Placing Documents .....	22	When you want to enhance text that is difficult to read because of factors such as the background of the scanned document .....	55
Documents .....	22	To correct tilted documents and images .....	55
Placing a Document into the Feeder .....	23	When you want to remove the black spots in scanned images while scanning documents with punch holes .....	55
Placing a Document on the Flatbed (Platen Glass) .....	25	When you want to detect multiple pages fed at the same time .....	56
Setting the Long Document Mode .....	26	When you want to match the orientation of images to the text when scanning a mixture of pages with different text orientations .....	56
Chapter 6 Scanning with CaptureOnTouch .....	28	When you want to rotate the images of a document placed horizontally to correct the orientation .....	57
What is CaptureOnTouch? .....	28	When you want to use multistream settings for scanning .....	57
Starting and Exiting CaptureOnTouch .....	29	When you want to remove dots and notches that appear in documents .....	58
		When you want to save a scanner driver setting .....	59
		Function Restrictions Depending on Mode Setting .....	59

Chapter 9 Regular Maintenance .....	61
Routine Cleaning .....	61
Cleaning the Roller Unit and Retard Roller .....	63
Adjusting the Reduction Ratio .....	66
Auto Power Off Setting .....	67
Chapter 10 Uninstalling the Software .....	68
Uninstallation .....	68
Chapter 11 Troubleshooting .....	69
Clearing a Paper Jam .....	69
Common Problems and Solutions .....	70
Useful tips .....	72
Chapter 12 Appendix .....	75
Specifications .....	75
Replacement Parts .....	76
External Dimensions .....	77

## Chapter 1 Introduction

Thank you for purchasing the Canon imageFORMULA DR-F120 Document Scanner.

In order to fully understand the features of this scanner and use them more effectively, please read this manual and the manuals shown below thoroughly before using the product. After reading, store the manual in a safe place for future reference.

About This Manual .....	4
Features of the Scanner .....	5
Names and Functions of Parts .....	6
Feeding Methods .....	7
Regulations .....	8
Trademarks .....	10

## About This Manual

### Manuals for the Scanner

Documentation for this scanner consists of the following manuals.

- Setup Guide  
This provides complete and comprehensive information about the scanner.
- User Manual (this manual)  
This manual contains complete explanations for operations on the scanner. This manual is stored on the supplied Setup Disk as an electronic manual.

The User Manual will be registered to the following location in the start menu after you install the software on the Setup Disk.

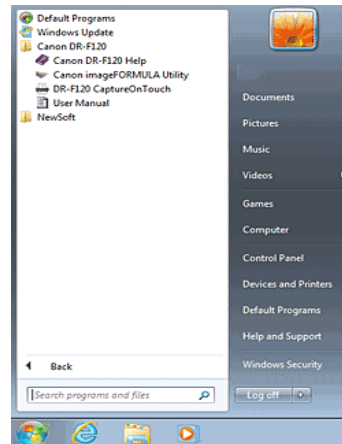

### NOTE

In Windows 8.1/8, it is registered at the following location.



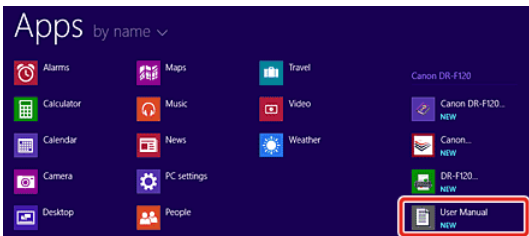

## Symbols Used in This Manual

The following symbols are used in this manual to explain procedures, restrictions, handling precautions, and instructions that should be observed for safety.



### WARNING

Indicates a warning concerning operations that may lead to death or injury to persons if not performed correctly. To use the machine safely, always pay attention to these warnings.



### CAUTION

Indicates a caution concerning operations that may lead to injury to persons, or damage to property if not performed correctly. To use the machine safely, always pay attention to these cautions.



### IMPORTANT

Indicates operational requirements and restrictions. Be sure to read these items carefully to operate the machine correctly, and avoid damage to the machine.



### NOTE

Indicates a clarification of an operation, or contains additional explanations for a procedure. Reading these notes is highly recommended.

## Features of the Scanner

The main features of the DR-F120 document scanner are described below.

- **ADF Scan**  
A stack of documents can be scanned with ADF at a maximum speed of 20 pages/min.  
(When set to black and white, 200 dpi, and A4/Letter size)
- **Flatbed scan**  
Documents that cannot be scanned by the feeder (e.g. thin paper, thick paper, magazines, and bound documents) can be scanned on the flatbed.  
The maximum size of the document that can be scanned is Legal size.
- **Color/Grayscale Support**  
Documents can be scanned in 24-bit color or 256-level grayscale.
- **Job Function**  
Documents can be scanned automatically by pressing preregistered buttons on the operation panel. Jobs are automatically processed by a preset method without the need to start up an application.
- **Paper Size Detection**  
The scanner automatically detects the size of a scanned document and eliminates any unnecessary space around the edges of the image when storing the image, even when storing a document of irregular size.
- **Deskew**  
The scanner straightens scanned images when it detects that the document was placed askew.
- **Full Auto Mode**  
A Full Auto Mode is provided in the supplied software, CaptureOnTouch, to allow scanning under automatically determined conditions. Scanning conditions such as the color mode and page size are set automatically based on the document being scanned.
- **Advanced Text Enhancement**  
Documents with dark backgrounds or documents with faint text written in pencil can be scanned clearly.

\* Note that this function may not function effectively, depending on the document type.

- **Moire Reduction**

This mode lessens the moire effect (a shimmering, wavy pattern) that may occur when color documents such as magazine photos are scanned.

- **Color Drop-out**

Specify certain color in the document so that it will be excluded in the scan.

- **Remove Punch Holes**

When scanning from the flatbed, this function erases the black spots that appear on a scanned image from documents that have had holes punched in them to be stored in a binder.

- **Character Orientation Detector**

This function identifies the orientation of characters in a document, and, if necessary, rotates the image so that the orientation of the scanned characters is correct.

- **Prescan Function**

The scanner is equipped with a Prescan function that allows you to adjust the contrast and brightness of a prescanned image and then send the adjusted image to the application software, without needing to scan the document again.

- **Character/Line Emphasis Function**

If characters and lines in scanned images are not clearly visible, you can use this function to adjust their thickness during scanning.

- **Energy Saving Mode**

This scanner is compatible with the International Energy Star Program, and is designed to save power by using the energy saving feature except when scanning is being performed.



## NOTE

Depending on the bundled software you are using, all of the preceding features may not be available.

## Names and Functions of Parts

### Front

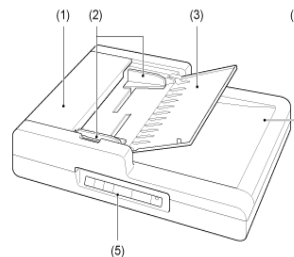

- (1) Feeder Cover  
Open this to clear paper jams or to perform cleaning.
- (2) Document Guides  
Adjust this to the width of the document.
- (3) Document Feed Tray  
Open this when placing documents into the feeder.
- (4) Document Eject Tray  
Documents scanned through the feeder are ejected here.
- (5) Operation Panel  
Buttons for operating the scanner are located here.

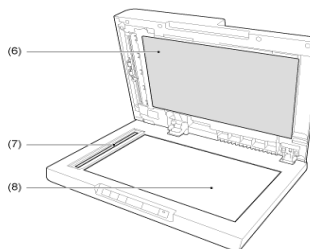

- (6) Pressure Board  
This presses documents placed on the flatbed against the glass.
- (7) Scanning Glass (Feeder)
- (8) Scanning Glass (Flatbed)  
Place documents here with their scanning sides facing down.

## Operation Panel

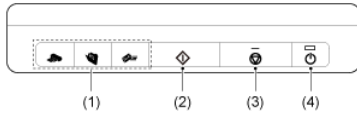

### (1) Job Buttons

Specific jobs are assigned to these buttons. Scanning will start when any of these buttons are pressed. The scanned images will be processed as follows for each button:

**COPY:** Prints scanned images to a specified printer.

**FILE:** Saves scanned images in a specified folder.

**E-MAIL:** Sends a new e-mail message with scanned images.

### (2) START Button

This button performs the following functions.

- Executes jobs selected with the user defined job buttons or scroll keys.
- Starts scanning when an application is used and the [Feeding Option] is set to [Panel-Feeding].
- Launches the application configured with the Windows Events function.

### (3) STOP Button

Press this button to stop scan procedures or clear error displays, such as those for paper jams.

### (4) POWER Button

Press this button to turn the scanner ON, and the power indicator will light.

When you press and hold this button (for 2 seconds) while the scanner is turned ON, the scanner and power indicator will turn OFF.



## NOTE

The scanner's auto power off setting is enabled by default, and the scanner will turn off automatically if it is not operated for 4 hours.

For details on how to disable this setting, see Auto Power Off Setting

## Feeding Methods

There are two methods of scanning documents using this scanner.

### Feeder

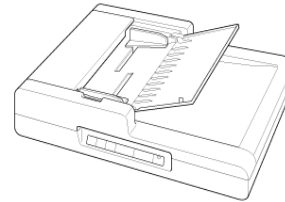

### Flatbed (Platen Glass)

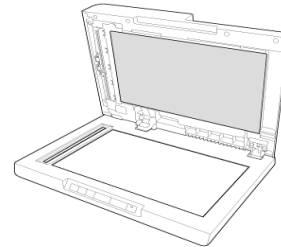

### Precautions for Using the Feeder

- When scanning a multipage document in a single scan procedure using the feeder, make sure that all of the pages are identical in thickness, and quality of paper. Feeding different types of paper at one time may cause a paper jam.
- Scanning documents before the ink is dry will make the rollers and scanning glass dirty, resulting in smears on the scanned

image and other documents becoming dirty. Always make sure that the ink on a document is dry before scanning it.

- Scanning documents that are written in pencil or similar material will make the rollers and scanning glass dirty, resulting in smears on the scanned image.
- When scanning thin paper, text or images on the reverse side of the page may bleed through onto the scanned image. In this case, adjust the brightness under the scanning conditions.
- Always make sure to check that paper clips, staples, and similar objects are not mixed in with a document before loading it into the feeder. The presence of such objects may result in damage to documents, paper jams, and damage to the scanner.
- Do not wear loose clothing or jewelry that may get caught in the scanner while you are using it. Doing so may result in personal injury. Be extra careful of neckties and long hair. If anything becomes caught in the scanner, immediately disconnect the power plug from the power outlet to stop the scanner.
- Documents with curled edges may result in folds and paper jams. Make sure to straighten out the curls before loading documents in the scanner.
- Handle paper edges with care, and be careful not to cut your fingers when loading documents.

## Regulations

---

### FCC REGULATIONS (For 120 V model)

Document Scanner, Model M111221

This device complies with Part 15 of the FCC Rules. Operation is subject to the following two conditions: (1) This device may not cause harmful interference, and (2) this device must accept any interference received, including interference that may cause undesired operation.

**Note:** This equipment has been tested and found to comply with the limits for a Class B digital device, pursuant to Part 15 of the FCC Rules. These limits are designed to provide reasonable protection against harmful interference in a residential installation. This equipment generates, uses, and can radiate radio frequency energy and, if not installed and used in accordance with the instructions, may cause harmful interference to radio communications. However, there is no guarantee that interference will not occur in a particular installation. If this equipment does cause harmful interference to radio or television reception, which can be determined by turning the equipment OFF and ON, the user is encouraged to try to correct the interference by one or more of the following measures:

- Reorient or relocate the receiving antenna.
- Increase the separation between the equipment and receiver.
- Connect the equipment into an outlet on a circuit different from that to which the receiver is connected.
- Consult the dealer or an experienced radio/TV technician for help.
- Use of shielded cable is required to comply with Class B limits in Subpart B of Part 15 of FCC Rules.

Do not make any changes or modifications to the equipment unless otherwise specified in the manual. If such changes or modifications should be made, you could be required to stop operation of the equipment.

Canon U.S.A. Inc.

ONE CANON PARK, MELVILLE, NY 11747, U.S.A.

Tel. No. (800)652-2666

## RADIO INTERFERENCE REGULATIONS (For 120 V models)

This digital apparatus does not exceed the Class B limits for radio noise emissions from digital apparatus as set out in the interference-causing equipment standard entitled "Digital Apparatus", ICES-003 of the Industry Canada.

## RÈGLEMENT SUR LE BROUILLAGE RADIOÉLECTRIQUE (For 120 V models)

Cet appareil numérique respecte les limites de bruits radioélectriques applicables aux appareils numériques de Classe B prescrites dans la norme sur le matériel brouilleur: "Appareils Numériques", NMB-003 édictée par l'Industrie Canada.

## International ENERGY STAR® Office Equipment Program



As an ENERGY STAR® Partner, CANON ELECTRONICS INC. has determined that this machine meets the ENERGY STAR® Program guidelines for energy efficiency.

The International ENERGY STAR® Office Equipment Program is an international program that promotes energy saving through the use of computers and other office equipment. The program backs the development and dissemination of products with functions that effectively reduce energy consumption. It is an open system in which business proprietors can participate voluntarily. The targeted products are office equipment, such as computers, monitors, printers, fax, machine, copiers, and scanners. The standards and logos are uniform among participating nations.

## European Union (and EEA) only.



This symbol indicates that this product is not to be disposed of with your household waste, according to the WEEE Directive (2002/96/EC) and your national law. This product should be handed over to a designated collection point, e.g., on an authorized one-for-one basis when you buy a new similar product or to an authorized collection site for recycling waste electrical and electronic equipment (EEE). Improper handling of this type of waste could have a possible negative impact on the environment and human health due to potentially hazardous

substances that are generally associated with EEE. At the same time, your cooperation in the correct disposal of this product will contribute to the effective usage of natural resources. For more information about where you can drop off your waste equipment for recycling, please contact your local city office, waste authority, approved WEEE scheme or your household waste disposal service. For more information regarding return and recycling of WEEE products, please visit [www.canon-europe.com/environment](http://www.canon-europe.com/environment).

(EEA: Norway, Iceland and Liechtenstein)

## Für EMVG

Dieses Produkt ist zum Gebrauch im Wohnbereich, Geschäfts- und Gewerbebereich sowie in Kleinbetrieben vorgesehen.

## Model Names

The following names may be provided for the safety regulations in each sales region of the Document Scanner.

DR-F120: Model M111221

## Disclaimers

The information in this document is subject to change without notice.

CANON ELECTRONICS INC. MAKES NO WARRANTY OF ANY KIND WITH REGARD TO THIS MATERIAL, EITHER EXPRESS OR IMPLIED, EXPECT AS PROVIDED HEREIN, INCLUDING WITHOUT LIMITATION, THEREOF, WARRANTIES AS TO MARKETABILITY, MERCHANTABILITY, FITNESS FOR A PARTICULAR PURPOSE OF USE OR NON-INFRINGEMENT. CANON ELECTRONICS INC. SHALL NOT BE LIABLE FOR ANY DIRECT, INCIDENTAL, OR CONSEQUENTIAL DAMAGES OF ANY NATURE, OR LOSSES OR EXPENSES RESULTING FROM THE USE OF THIS MATERIAL.

CANON ELECTRONICS INC. IS NOT LIABLE FOR THE STORAGE AND HANDLING OF DOCUMENTS SCANNED WITH THIS PRODUCT, OR THE STORAGE AND HANDLING OF RESULTING SCANNED IMAGE DATA.

IF YOU INTEND TO DISCARD THE ORIGINALS OF SCANNED DOCUMENTS, YOU THE CUSTOMER ARE RESPONSIBLE FOR

INSPECTING THE SCANNED IMAGES AND VERIFYING THAT DATA IS INTACT.

THE MAXIMUM LIABILITY OF CANON ELECTRONICS INC. UNDER THIS WARRANTY IS LIMITED TO THE PURCHASE PRICE OF THE PRODUCT COVERED BY THE WARRANTY.

## Trademarks

---

- Canon and the Canon logo are registered trademarks, of Canon Inc. in the United States and may also be trademarks or registered trademarks in other countries.
- imageFORMULA is a trademark of CANON ELECTRONICS INC.
- Microsoft, Windows, Windows Vista, PowerPoint, and SharePoint are registered trademarks or trademarks of Microsoft Corporation in the United States and other countries.
- Microsoft product screen shot(s) reprinted with permission from Microsoft Corporation.
- ENERGY STAR® is a registered trademark of the United States Environmental Protection Agency.
- ISIS is a registered trademark of EMC Corporation in the United States.
- Google and Google Drive are trademarks of Google Inc.
- Dropbox is a trademark or registered trademark of Dropbox, Inc. in the United States.
- SugarSync is a registered trademark of SugarSync Inc. in the United States.
- Evernote is a registered trademark or trademark of Evernote Corporation.
- Adobe, the Adobe logo, Acrobat, the Adobe PDF logo, and Adobe Reader are either registered trademarks or trademarks of Adobe Systems Incorporated in the United States and/or other countries.



Powered by  
ADOBE® PDF LIBRARY

- Other product and company names herein may be the trademarks of their respective owners. However, the TM and R symbols are not used in this document.

## Copyright

Copyright 2014 by CANON ELECTRONICS INC. All rights reserved.

No part of this publication may be reproduced or transmitted in any form or by any means, electronic or mechanical, including photocopying and recording, or by any information storage or retrieval system without the prior written permission of CANON ELECTRONICS INC.

## Chapter 2 Important Safety Instructions

To ensure the safe operation of this scanner, be sure to read the safety warnings and precautions described below.

Installation Location.....	11
AC Adapter .....	12
Moving the Scanner.....	12
Handling .....	12
Disposal.....	14
When sending the scanner for repairs.....	14

## Installation Location

The performance of this scanner is affected by the environment in which it is installed. Make sure that the location where the scanner is installed meets the following environmental requirements.

- Provide adequate space around the scanner for operation, maintenance, and ventilation.

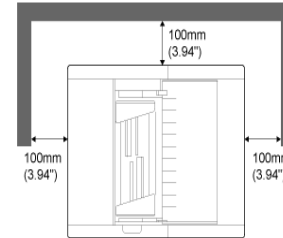

- Avoid installing the machine in direct sunlight. If this is unavoidable, use curtains to shade the scanner.
- Avoid locations where a considerable amount of dust accumulates.
- Avoid warm or humid locations, such as in the vicinity of a water faucet, water heater, or humidifier.
- Avoid locations where ammonia gas is emitted.
- Avoid locations near volatile or flammable materials, such as alcohol or paint thinner.
- Avoid locations that are subject to vibration.
- Avoid exposing the scanner to rapid changes in temperature. If the room in which the scanner is installed is cold but rapidly heated, water droplets (condensation) may form inside the scanner. This may result in a noticeable degradation in scanning quality.
- The following conditions are recommended for optimal scanning quality:
  - Room temperature: 10 °C to 32.5 °C (50 °F to 90.5 °F)
  - Humidity: 20% to 80% RH
- Avoid installing the scanner near equipment that generates a magnetic field (e.g. speakers, televisions, or radios.)



## AC Adapter

---

- Connect only to a power outlet of the rated voltage and power supply frequency (120 V, 60 Hz or 220-240 V, 50/60 Hz depending on your region).
- Do not connect other electrical equipment to the same power outlet to which the scanner is connected. Also, when using an extension cord, make sure that the extension cord is rated for the current requirements of the scanner.
- Never disassemble or modify the AC adapter, as it is dangerous.
- The power cord may become damaged if it is often stepped on or if heavy objects are placed on it. Continued use of a damaged power cord and AC adapter can lead to an accident, such as a fire or electrical shock.
- Do not use the power cord while it is coiled.
- Do not pull directly on the power cord. When disconnecting the power cord, grasp the plug and remove it from the outlet.
- Keep the area around the power cord clear of objects so that the power cord can be disconnected easily in an emergency.
- Do not use an AC adapter or power cord other than those provided with the scanner. Do not use the AC adapter or power cord provided with the scanner with other products.
- If you have any questions regarding the power supply, contact your local authorized Canon dealer or service representative for further information.

## Moving the Scanner

---

- Before moving the scanner, make sure to turn the power switch OFF, and disconnect the power plug from the power outlet.
- Make sure to disconnect any interface cables and the AC adapter when moving the scanner. If the scanner is carried with these items connected, the plugs and connectors may be damaged or cause the scanner to fall and result in personal injury or damage to the scanner.

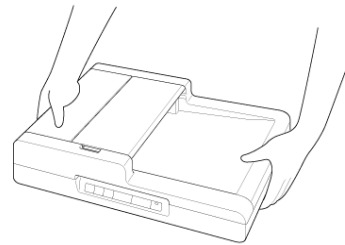

## Handling

---



### WARNING

Note the following precautions whenever using the scanner. Failure to do so may result in a fire or electric shock.

- Never use alcohol, benzene, paint thinner, aerosol sprays, or any other highly flammable substance near the scanner.
- Do not cut, damage, or modify the power cord. Do not place heavy objects on the power cord, and do not pull or excessively bend the power cord.
- Never connect the power cord when your hands are wet.
- Do not connect the scanner to a multi plug power strip.
- Do not knot or coil the power cord as this may result in a fire or electric shock. When connecting the power cord, make sure that the power plug is securely and completely inserted into the power outlet.
- The supplied power cord set is intended for use with this scanner only. Do not use it with other electronic equipment. In addi-



tion, do not use power cord sets other than the one supplied with the scanner. Doing so may result in fire or electric shock.

- Do not take the scanner apart or modify it.
- Never try to take the AC adapter apart or modify it in any way, as this is dangerous.
- Do not use flammable spray near the scanner.
- When cleaning the scanner, push the power button to turn it OFF and disconnect the power cord from the power supply.
- Clean the scanner using a slightly dampened cloth which has been well wrung out. Never use alcohol, benzene, paint thinner, or any other flammable substances.
- If the scanner makes strange noises, or gives off smoke, heat, or strange odors, or the scanner does not function or other abnormalities occur when you use the machine, immediately push the power button to turn it off, and disconnect the power plug from the power outlet. Then, contact your local authorized Canon dealer or service representative to have the unit serviced.
- Do not drop the scanner, or subject it to impact or strong shock. Should the scanner ever become damaged, immediately push the power button to turn it OFF, and disconnect the power plug from the power outlet. Then, contact your local authorized Canon dealer or service representative to have the unit serviced.
- Before moving the scanner, be sure to push the power button to turn it OFF, and disconnect the power plug from the power outlet.

## CAUTION

- Do not install the scanner on a surface that is unstable or tilted, or in an area subject to excessive vibrations, as this may cause the scanner to fall, resulting in personal injury or damage to the scanner.
- Do not block the ventilation openings. Doing so may cause the scanner to overheat, creating a risk of fire.
- Never place small metal objects such as staples, paper clips, or jewelry on the scanner. These items may fall into the scanner, and cause a fire or electric shock. Should such objects ever fall inside the scanner, immediately turn the power OFF, and disconnect the power plug from the power outlet. Then, contact

your local authorized Canon dealer or service representative to have the unit serviced.

- Do not install the scanner in a humid or dusty location. Doing so might cause a fire or electric shock.
- Do not place objects on top of the scanner. Such objects may tip or fall over, resulting in personal injury.
- Connect only to a power outlet of the rated voltage and power supply frequency (120 V, 60 Hz or 220-240 V, 50/60 Hz depending on your region).
- When unplugging the power cord, grasp it firmly by its plug. Do not pull directly on the power cord, as this may damage or expose the cord's internal wiring, resulting in a fire or electric shock.
- Leave sufficient space around the power plug so that it can be unplugged easily. If objects are placed around the power plug, you will be unable to unplug it in an emergency.
- Do not allow water or flammable substances (alcohol, paint thinner, benzene, etc.) to spill into the scanner, as this may result in a fire or electric shock.
- Turn the power OFF for safety when not using the scanner for a long period of time, such as overnight. Also, turn the power OFF, and disconnect the power cord from the power outlet for safety when the machine will not be used for an extended period of time, such as during consecutive holidays.
- Do not wear loose clothing or jewelry that may get caught in the scanner while you are using it. This may result in personal injury. Be extra careful of neckties and long hair. If anything becomes caught in the scanner, immediately disconnect the power cord to stop the scanner.
- Be careful when loading paper into the scanner and when removing jammed paper. It is possible to cut your hand on the edge of a sheet of paper.
- Open and close the feeder carefully and slowly. Failure to do so may result in malfunction or personal injury.
- Take care to avoid pinching your hands when closing the feeder. Failure to do so may result in personal injury.
- Do not press down hard on the feeder. Doing so may result in damage to the glass, malfunction, or personal injury.
- Never place any object other than documents to be scanned on to the feeder's feed and eject areas. Doing so may result in malfunction or personal injury.

## **Disposal**

---

---

When disposing of this scanner, be sure to follow all local ordinances and laws or consult with the retailer who sold you the scanner.

## **When sending the scanner for repairs**

---

---

When a request is made for repairs, the scanner needs to be sent to the specified address. When sending the scanner, use the packing box in which it came. Firmly secure the scanner with packaging material when you place it in the packing box.

## Chapter 3 Installing the Software

This section describes the software installation procedure using the setup disk that comes with this product.

System requirements.....	15
Setup Disk Contents.....	16
Software Installation .....	17

## System requirements

The following system requirements are recommended for optimal use of this scanner.

- Computer
  - CPU: Intel Core 2 Duo 1.66 GHz or faster
  - Memory: 1 GB or more
  - Hard disk: 3 GB or more available space required for installation of all software
  - USB interface: Hi-Speed USB 2.0
  - Monitor: Resolution of 1024 x 768 (XGA) or better recommended.
  - Optical drive
- Operating system
  - Microsoft Windows XP Service Pack 3 or later
  - Microsoft Windows XP x64 Edition Service Pack 2 or later
  - Microsoft Windows Vista Service Pack 2 or later (32-bit and 64-bit editions)
  - Microsoft Windows 7 Service Pack 1 or later (32-bit and 64-bit editions)
  - Microsoft Windows 8 or 8.1 (32/64-bit version)
  - Microsoft Windows Server 2008 R2 Service Pack 1 or later
  - Microsoft Windows Server 2012 R2
- Other requirement
  - An ISIS-compatible application or a TWAIN-compatible application that is compatible with the above operating systems.
  - .NET Framework 4.0 or later



### IMPORTANT

- Use the USB interface provided as standard with your computer. However, normal operation is not guaranteed with all USB interfaces, even if present as standard equipment on the computer. For details, consult your local authorized Canon dealer.
- Scanning speeds are lower if your computer's standard USB interface is USB Full-Speed (equal to USB 1.1.)
- The USB cable you are using should be the one originally included with the scanner.
- If the CPU, memory, interface card, and other specifications do not satisfy the installation requirements, the scanning speed may be greatly reduced and transmission may take a long time.

- Even if the computer satisfies the system requirements, the scanning speed may vary, depending on the specifications and operating environment of the computer and the specified scan settings.
- The scanner drivers provided with the scanner do not necessarily operate on all ISIS or TWAIN-compatible applications. For details, contact your application software retailer.

You will be asked to agree to terms of service when obtaining an account. For details, refer to the website of your cloud service provider.

Simple installation of the above software does not require an account.

### Precautions for Use in 64-bit Operating Systems

- The scanner driver supplied with this product supports scanning with 32bit applications only.
- Even with 32-bit applications, not all ISIS/TWAIN compliant applications are guaranteed to operate.
- Scanning speed may vary depending on the specifications of your computer.

## Setup Disk Contents

---

Install the following software necessary for using the scanner from the supplied Setup Disk.

- CaptureOnTouch  
This is a dedicated scanning utility for this product.
- Scanner Driver  
This is the scanner driver for this product.

### Cloud Service Software

For some of the supplied third-party software, a cloud service account is required to use some or all of their functions.

Software	Cloud service used
Google docs plug-in for CaptureOnTouch	Google Drive
Evernote	Evernote
CaptureOnTouch plug-in for Evernote	Evernote
CaptureOnTouch plug-in for Dropbox	Dropbox
CaptureOnTouch plug-in for SugarSync	SugarSync
CaptureOnTouch plug-in for Microsoft OneDrive	Microsoft OneDrive

# Software Installation

The procedure for installing the software is as follows:



## IMPORTANT

Install the software before connecting the scanner to the computer.

- Log on to Windows as an Administrator.
- Close all other applications before installing the software.

### 1 Insert the Setup Disk into the disk drive of the computer.

The setup menu automatically starts up when you insert the disk into the drive. (If the menu does not start up, execute setup.exe from the disk.)

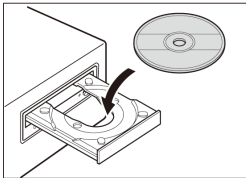

For Windows 8.1/8/7/Vista

If the [User Account Control] screen appears, click [Yes] or [Allow].

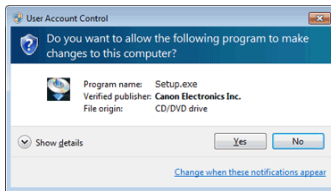

### 2 Click [Typical Installation].

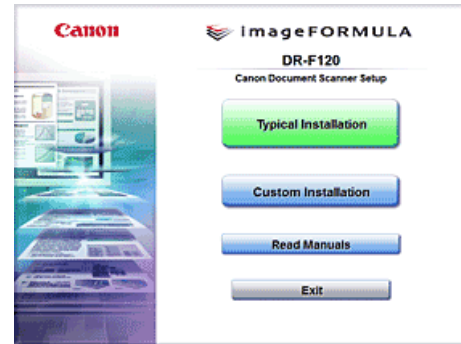

## NOTE

If you want to reinstall only specific software that you have previously uninstalled, select [Custom Installation] and specify the software.

### 3 Click [Install].

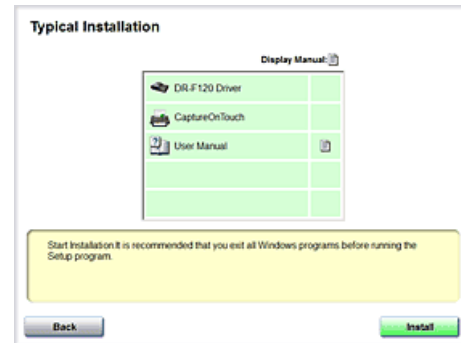

4 Follow the instructions on the screen to complete installation.

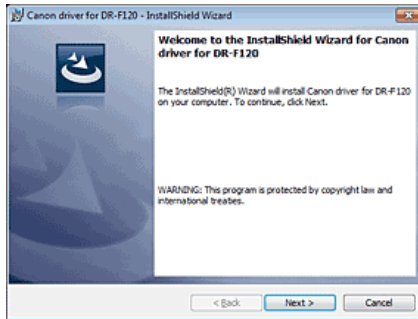

5 Click [Exit] to finish installing the software.



## NOTE

Installation of EMC Cloud Capture Function

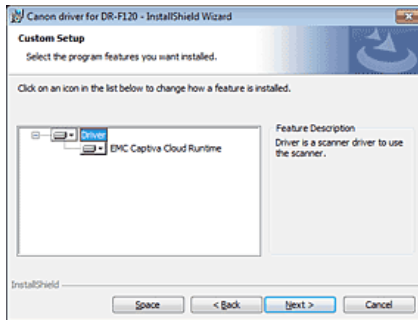

- EMC Captiva Cloud Runtime provides a component that enables the use of web-based applications.
- The applications need to support this function when enabling this function. Be sure to install it only when you are using a supported application.

## Chapter 4 Connecting the Scanner

Connect the scanner to the computer and power outlet.

Connecting the Scanner to the Computer ..... 19

Turning the Power ON ..... 20

## Connecting the Scanner to the Computer

Connect the scanner to the computer.



### IMPORTANT

- Do not connect the scanner to the computer before installing the software.
- Before connecting the scanner to the computer, verify that the power of the scanner is OFF. If the power is ON, turn it OFF.

#### 1 Connect the power cord to the AC adapter.

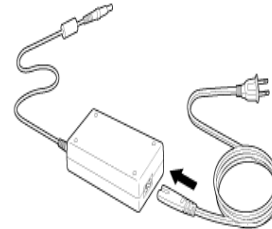

#### 2 Connect the plug of the AC adapter to the power connector on the back of the scanner.

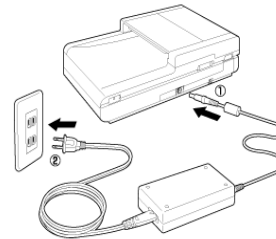

- 3 Use the supplied USB cable to connect the scanner to the computer.**

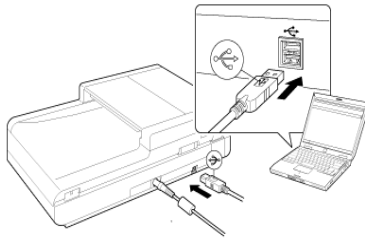

## Turning the Power ON

The power of the scanner can be turned ON and OFF with the power button on the front of the scanner.

- 1 Make sure that the scanner and computer are connected properly with a USB cable.**
- 2 Press the power button.**

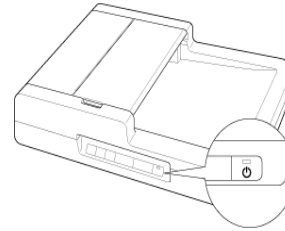

The power indicator lights blue when the power is ON.

### NOTE

When the scanner is turned on for the first time, the balloon message shown below appears on the Windows task bar. If you wait a while, automatic scanner recognition will end and the scanner will become ready to use.

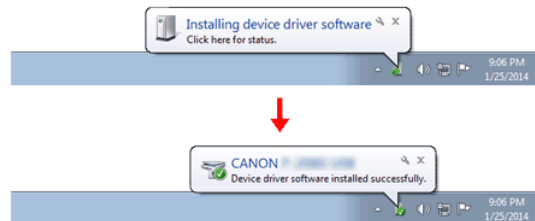

When the scanner is properly connected to the computer, the  (CaptureOnTouch) icon appears on the taskbar as follows.





If the taskbar icon appears as , the scanner is not properly connected to the computer. Check the status of the power and USB cable.

### Turning Off the Power

Press and hold the power button until the indicator goes out.



#### IMPORTANT

- After turning the scanner off, wait at least 10 seconds before turning it back on.
- If you will not be using the scanner for an extended period, you should disconnect the power cord from the AC outlet for safety.



#### NOTE

The scanner's auto power off setting is enabled by default, and the scanner will turn off automatically if it is not operated for 4 hours.

For details on how to disable this setting, see "Auto Power Off Setting" on p.67.

## Chapter 5 Placing Documents

There are two methods of scanning documents using this scanner.

Documents.....	22
Placing a Document into the Feeder .....	23
Placing a Document on the Flatbed (Platen Glass).....	25
Setting the Long Document Mode .....	26

## Documents

The scanner can scan documents ranging in size from business cards and checks to A4/LTR/LGL. The document sizes that this scanner can scan are shown below.

### Documents

The scanner can scan documents of the following sizes:

#### Feeder

Width:	51 mm to 216 mm (2" to 8.5")
Length:	89 mm to 356 mm (3.5" to 14.0") (You can scan documents up to 1,000 mm (39.3") long by setting the scanner to the Long Document mode.)
Thickness:	35 to 128 g/m <sup>2</sup>
Capacity:	50 sheets or stacked to a height of 6.0 mm (0.2") (including curling)

#### Flatbed (Platen Glass)

Width:	216 mm (8.5")
Length:	356 mm (14")

Make sure to thoroughly read the following cautions for scanning documents using the feeder:

- When scanning a stack of documents using the feeder, make sure that the documents are of the same size, stock, and paper quality. Feeding documents of different sizes or types together may cause a paper jam.
- Always make sure that the ink on a document is dry before scanning it. Scanning documents with the ink still wet may soil the rollers or scanning glass, cause lines or smudges to appear on images, or dirty other documents.
- Always clean the rollers or scanning glass after scanning a document written in pencil. Scanning documents with pencil written on them may soil the rollers or scanning glass, cause stripes to appear in images, or dirty other documents.
- When scanning a two-sided document that is printed on thin paper, the image on the opposite side of each page may show

through. Adjust the brightness in the scanning conditions before scanning the document.

- Scanning the following types of documents using the feeder may cause paper jams or malfunctions. Scan documents like these using the flatbed (platen glass).



Wrinkled or creased documents



Curled paper



Torn documents



Documents with paper clips or staples



Carbon paper



Coated paper



Extremely thin, translucent paper



Documents with excessive paper dust particles.

### Business Card

Size: 51mm × 89mm (2.01" × 3.50") or larger  
Paper weight: 128 to 209.5 g/m2 (0.15 mm to 0.25 mm)  
Orientation: Vertical feeding only



### IMPORTANT

If a stack of business cards cannot be fed properly, reduce the number of cards in the stack.

## Placing a Document into the Feeder

- 1 Open the document feed tray.

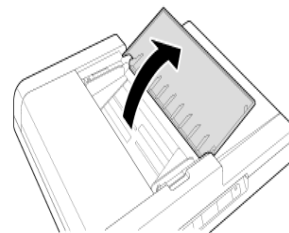

- 2 Ruffle and sort the documents, and then set the documents with the surfaces to be scanned facing up.

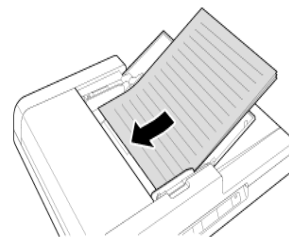

- 3 Adjust the document guides to fit the width of the document.

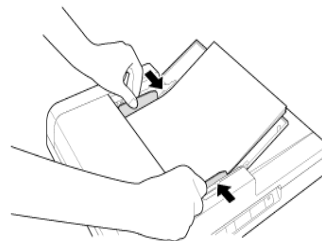

The document can now be scanned.



## NOTE

Before scanning, make sure that the document is not curled or creased, and that it is placed in the feed tray correctly. Scanning an improperly placed, curled, or creased document may damage the document or cause a paper jam.



## CAUTION

When placing documents into the feed tray, take care not to cut your hands on the edges of the paper.



## IMPORTANT

- Before you place a document, check to make sure it does not contain paper clips, staples, or other small metal objects. These items may cause a fire or electrical shock, damage the document, or cause a paper jam or scanner malfunction.
- Do not wear loose clothing or jewelry that may get caught in the scanner while you are using it. This may result in personal injury. Be extra careful of neckties and long hair. If anything gets caught in the scanner, immediately turn the power OFF, and disconnect the power cord from the power outlet to stop scanning.
- Always smooth out any folds or curls in your documents before placing them into the feeder. If the leading edge of a document is curled, it may cause a paper jam.
- If feeding stops due to a system error or paper jam while the scanner is scanning, resolve the problem, make sure that the scanned image of the last page that was successfully fed has been stored, and then resume scanning the remaining document pages.
- After you finish scanning, close the document feed tray and the document eject tray to prevent damage to the scanner while it is not being used.

### Documents That Contain Differently-Sized Pages

Place the document so that each page is centered between the document guides.

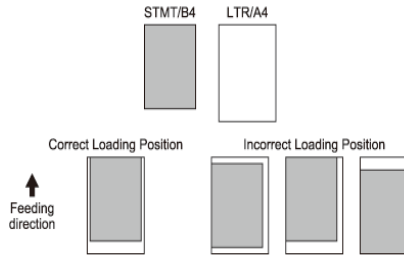

## Placing a Document on the Flatbed (Platen Glass)

---

- 1 Carefully open the feeder.

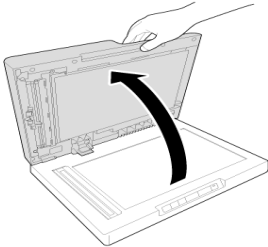

### IMPORTANT

Never place any object other than documents to be scanned onto the platen glass. Doing so may result in damage to the scanner or an injury.

- 2 Place the document face down and align the top edge of the document with the back edge of the platen glass (by the alignment mark in the top left corner).

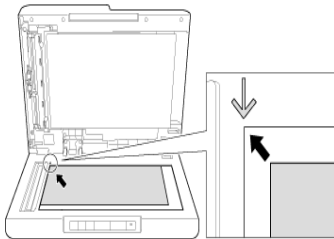

- 3 Carefully close the feeder.

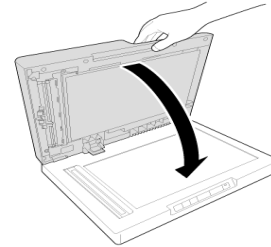

### CAUTION

- Close the feeder gently to avoid catching your fingers, as this may result in personal injury.
- Do not use excessive force when closing the feeder, as this may damage or break the platen glass, and may result in personal injury.
- Do not press down hard on the feeder when using the platen glass to scan thick books. Doing so may damage the platen glass and result in personal injury.

## Setting the Long Document Mode

The length of documents that can be scanned with the scanner is normally 356 mm (14"), but you can scan documents up to 1,000 mm (39.3") long by setting the scanner to the Long Document mode.



### IMPORTANT

Note the following when using the Long Document mode:

The Long Document mode cannot be used with the 2400 dpi resolution.

- When scanning in the Long Document mode, if the document is placed on the scanner in a skewed position, it may hit the edges of the feeding area and be damaged. Be careful to place the document so that it is not skewed.
- When scanning with the Long Document mode, paper jam detection may react slowly, resulting in damage to the document. Be careful to avoid paper jams.
- When scanning large-sized documents with the Long Document mode, scanning may be slower. Errors may also occur due to memory shortage and scanning may be disabled.



### IMPORTANT

Log on to Windows as an Administrator.

- 1 Click the Start button, and then click [All Programs], [Canon DR-F120], and [Canon imageFORMULA Utility]. imageFORMULA Utility starts.

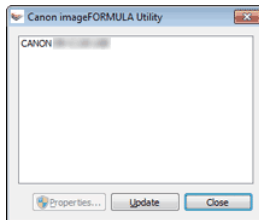

### NOTE

In Windows 8.1/8, it is registered at the following location.

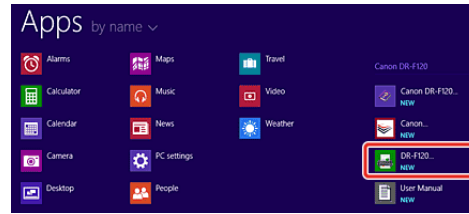

- 2 Click [CANON DR-F120 USB] and click [Properties]. Scanner properties are displayed.
- 3 Select a Long Document mode.

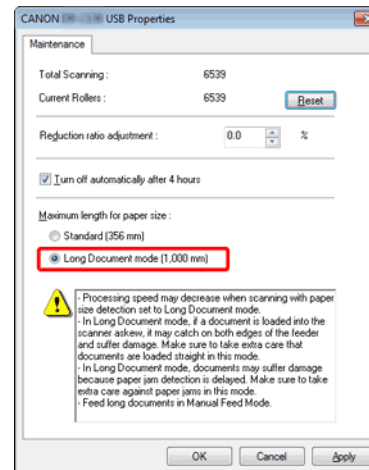

- 4 Click [OK].

## Setting Scanning Conditions

Configure scanning conditions as follows when scanning documents in Long Document mode.

- CaptureOnTouch  
Set [Page Size] to [Match original size] under [Scanner setting].  
-> "Select document settings" on p.40
- Scanner driver  
Set [Page Size] to [Match original size] in the [Basic] tab. ->  
"Setting Basic Scanning Conditions" on p.50

## Chapter 6 Scanning with CaptureOnTouch

This section describes the scanning procedure when using CaptureOnTouch.

- What is CaptureOnTouch?.....28
- Starting and Exiting CaptureOnTouch .....29
- Screen Descriptions.....30
- Standard Scanning .....31
- Scanning Shortcut .....33
- Scanning with Start Button .....36
- Operations for the scanned image edit window .....37
- Select document settings.....40
- Setting the output.....42
- Scanning Shortcut setting.....43
- About file formats.....43
- Environmental Settings.....45

### What is CaptureOnTouch?

CaptureOnTouch is a scanning application that enables you to scan a document with a simple operation merely by selecting the screen panel.

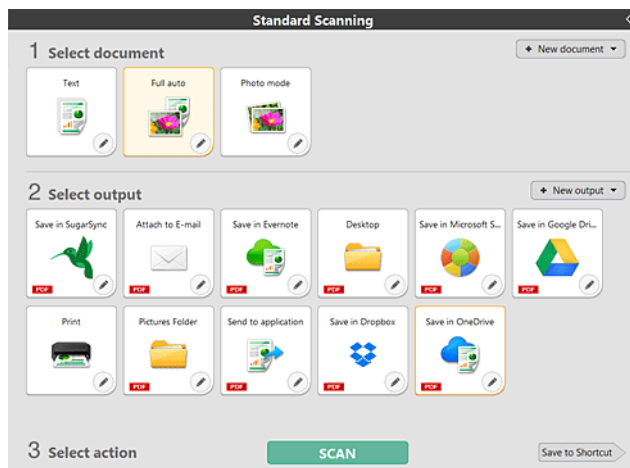

CaptureOnTouch is provided with multiple scanning methods that can be selected according to the purpose and application.

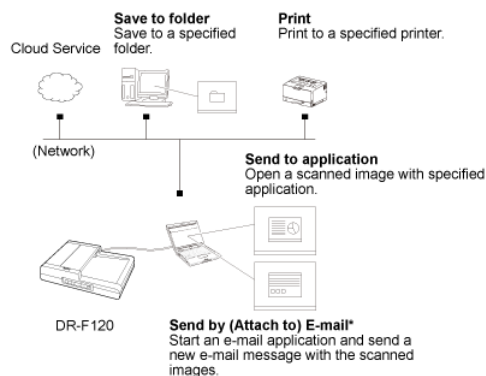

CaptureOnTouch supports the following scanning methods.



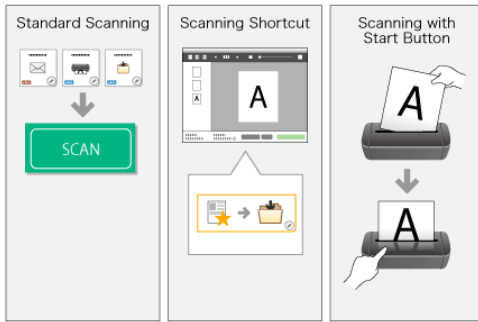

## Standard Scanning

Click the Select document and Output panels, and then click the [Scan] button to scan the document. You can select the scan method according to the document type and purpose of use before scanning.

-> "Standard Scanning"

## Scanning Shortcut

You can register in advance combinations of frequently-used document selections and output methods as a "Scanning Shortcut". Just click the Scanning shortcut panel to implement the scan.

-> "Scanning Shortcut"

## Start button

"Scanning shortcuts" are allocated to the scanner start button in advance. Set the document and press the Start button to start the scan. You can also allocate your own shortcuts to the start button.

-> "Scanning with Start Button"

## Starting and Exiting CaptureOnTouch

By default, CaptureOnTouch becomes resident in the system when you start your computer.



Double-click  (CaptureOnTouch icon) in the taskbar to start CaptureOnTouch and display the main window.



## NOTE

- You can also start CaptureOnTouch from the Start menu. Click [Start] - [All Programs] - [Canon DR-xxx] - [DR-xxx CaptureOnTouch].
- The interval between the time you press the Start button on the scanner and the time scanning begins is shortened when the [Make CaptureOnTouch resident] check box is selected in the [Basic settings] tab of the [Environmental settings] dialog box. For details, see "Environmental Settings" on p.45.

## Exiting CaptureOnTouch

To close the CaptureOnTouch window, click  at the top of the window. This closes the window, but CaptureOnTouch will continue to reside in the system.

To quit the CaptureOnTouch application, click  (CaptureOnTouch icon) in the taskbar, and select [Exit] from the menu.

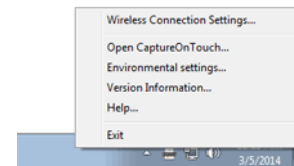

CaptureOnTouch becomes no longer resident in the system and the icon disappears from the taskbar.

## Restarting CaptureOnTouch

To use CaptureOnTouch after it has been made not resident in the system, use one of the following procedures to restart it.

CaptureOnTouch will start and become resident in the system again.

- Click [Start] - [All Programs] - [Canon DR-xxxx] - [DR-xxxx CaptureOnTouch].
- Press the Start button on the scanner (in this case, the main screen of CaptureOnTouch will open and scanning will start using the scan method assigned to the Start button).



## NOTE

In Windows 8.1 / 8, it is registered in the following location.

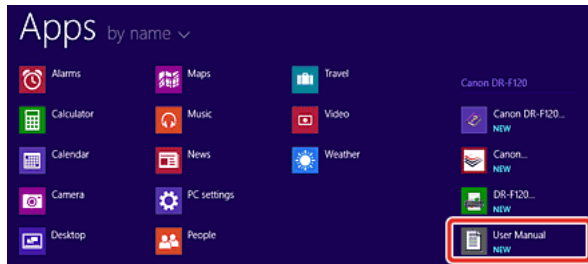

## Screen Descriptions

There are two areas in the CaptureOnTouch main screen, [Scanning Shortcut] and [Standard Scanning].

Use the [>] [<] at the top right of the main window to move between sections.

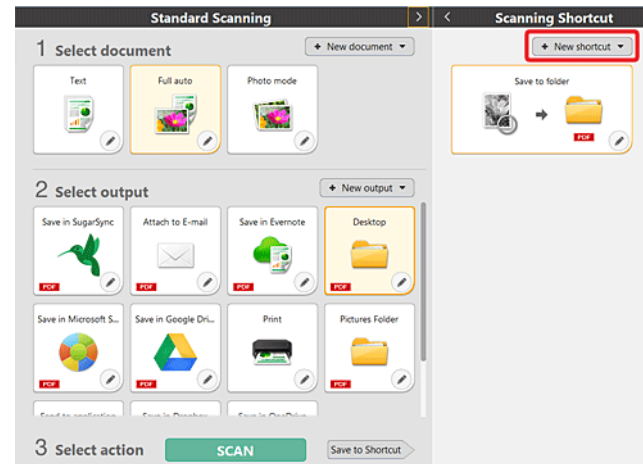

Various panels have been prepared according to the scan types and outputs in each section.

Click the [New document] button, and a [New document] panel will be added.

# Standard Scanning

Operations;

Selecting the Select document panel-> Selecting the Select output panel->Start scanning

- 1 Place the document in the scanner.
- 2 Click the select document panel for the document to be scanned from [1 Select document].

The selected [Select document] panel will be displayed in orange. To edit scan images, see "Select document settings".

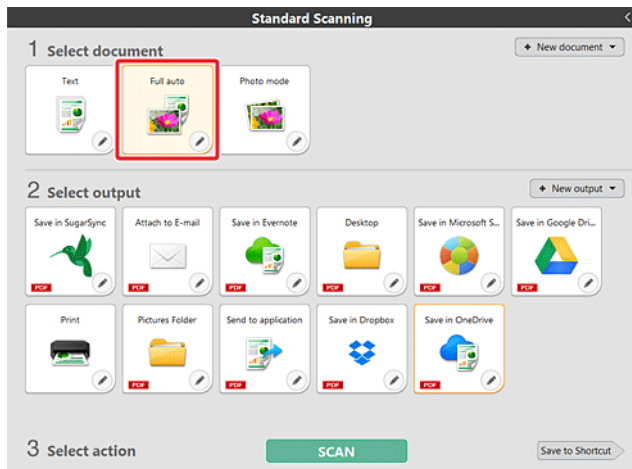

- 3 Click the output panel for the scan image application from [2 Output].

The selected [Output] panel will be displayed in orange. To edit the [Output] panel, see "Setting the output".

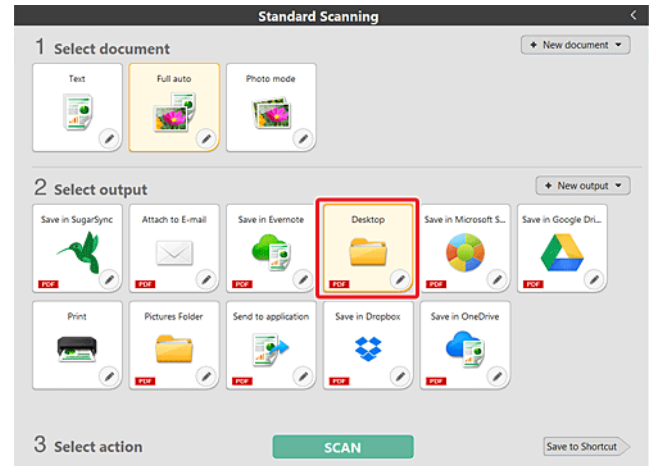

- 4 Click the [SCAN] button.

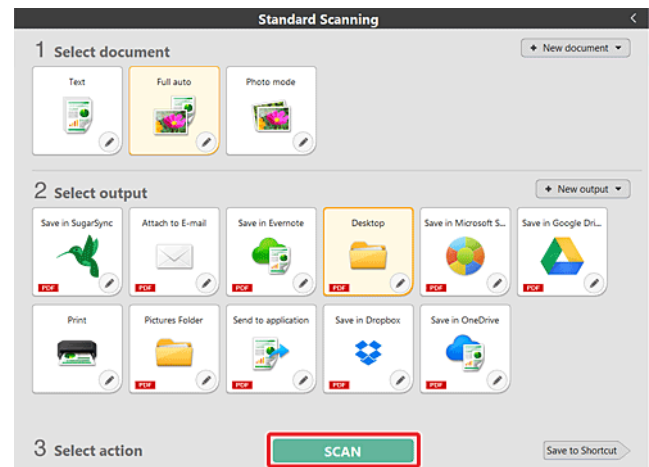

The document is scanned. While scanning is in progress, the number of pages scanned is displayed in addition to the scanner settings.

When the scan is finished, the [Scanned image preview screen] opens.



## NOTE

If using the same document selection and output combination the next time, click the [Save to Shortcut] button.

The Select document and Select output that you selected are added to Scanning Shortcut. A new panel is added in the Scanning Shortcut panel view.



## CAUTION

- If you configure scanning conditions that consume a large amount of the computer's memory, scanning may stop because of insufficient memory. If an error message appears due to insufficient memory while scanning is in progress, stop scanning, change the scanning conditions, and then try scanning again.
- A multiple-page scan cannot be saved when it reaches the file size of 2 GB. Change the save settings if an error message is displayed.



## NOTE

If scanning continuously, set the next document, and click the [Scan more pages] button to start the document scan.

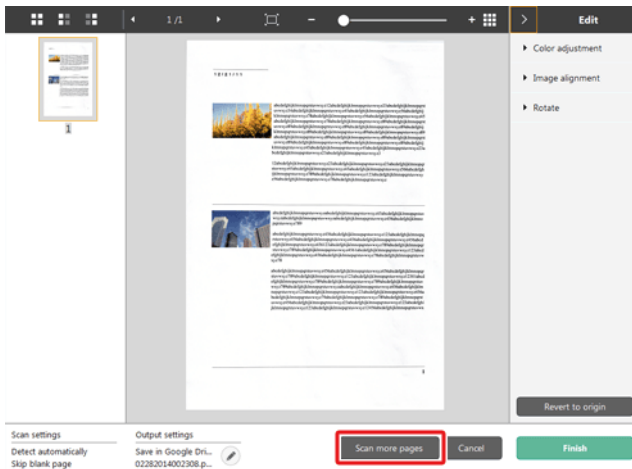

## 5 To check the scanned image, click the [Finish] button.

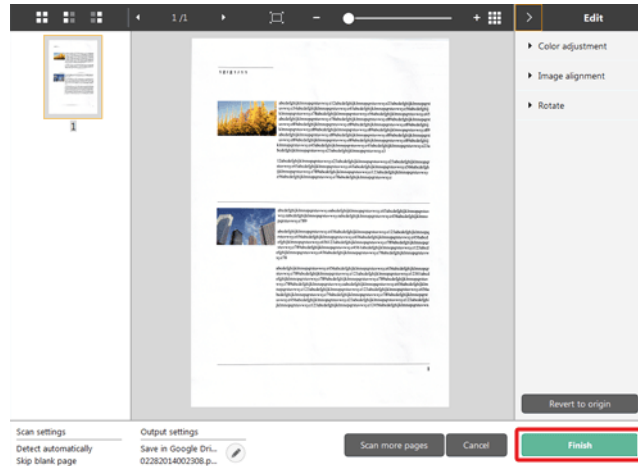

To edit scan images, see "Operations for the scanned image edit window" on p.37.

Click the [ ] button to edit the output settings. -> "Setting the output"  
Click the [Cancel] button to discard the scanned image and return to the main window.

When the output has finished, a popup window will be displayed. If saving the scanned image, a link to open the save destination folder will be displayed.

This completes the Standard Scanning.

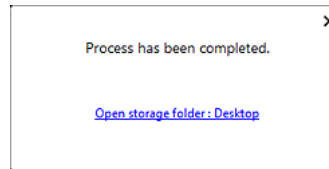

## NOTE

If you click [Open storage folder], the folder in which the saved scanned images were saved opens. Depending on the output settings, the [Open storage folder] button may not be displayed.

# Scanning Shortcut

Operations;

Save [Scanning Shortcut] -> Scan the document -> Output the scanned images

By adding scanning shortcuts that combine frequently-used document selections and outputs, you can scan just by clicking the Scanning Shortcut panel.



If a registered scanning shortcut is allocated to the start button, you can implement shortcut scans using these settings just by pressing the scanner start button -> "Scanning with Start Button"

## Registering and editing scanning shortcuts

Multiple scanning shortcuts can be allocated to CaptureOnTouch.

- 1 Either click the [New shortcut] button in [Scanning shortcut], or select the document scan and output in [Standard Scanning], and click the [Save to Shortcut] button.

A scanning shortcut panel will be created.

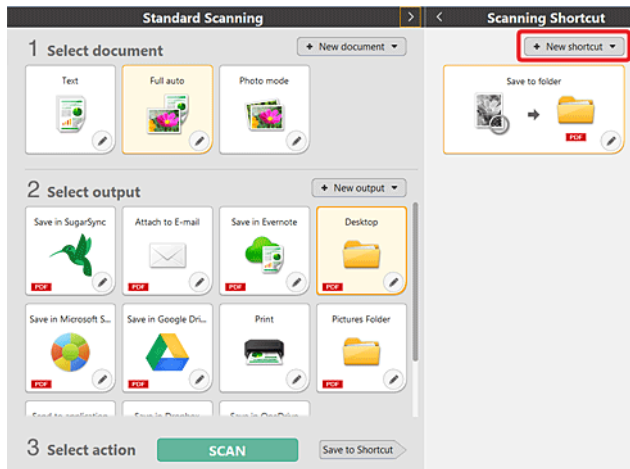

You can also create a new Destination panel by clicking [ ] on the [New] button, and in the menu that appears, selecting the type of Scanning Shortcut.

- 2 The Edit Scanning Shortcut Panel dialog box appears when you click the Edit button.

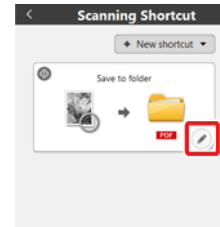

- 3 Click the [Document] tab to set the Select document settings. -> "Select document settings"

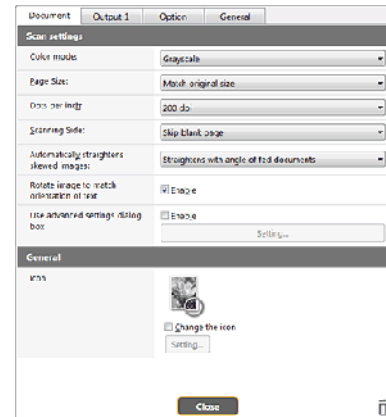

#### 4 Click the [Output] tab to set the outputs. -> "Setting the output"

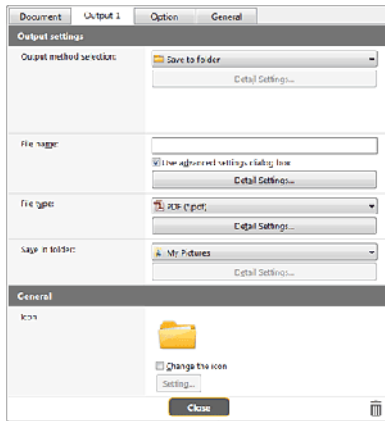

#### 5 Click the [Option] tab to set the options.

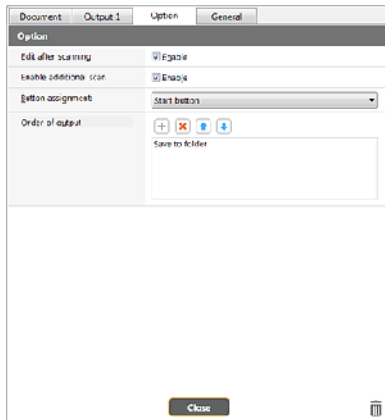

#### [Edit after scanning]

Check it on to enable modifying the scanned images in Scan Editing screen. When unchecked, the Edit window is not displayed in Scan Editing screen. -> "Operations for the scanned image edit window"

#### [Enable additional scan]

Check it on to display [Scan more pages] button in the Scan Editing screen to enable continuing scanning.

#### [Button assignment]

You can allocate one of the settings registered in scanning shortcuts to the scanner start button.

If a scanning shortcut is allocated to the start button, its icon will be displayed in the scanning shortcuts panel.

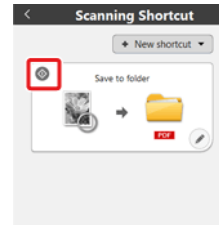

#### [Order of output]

Click each button to configure "Adding and Deleting output," and "Order change".

#### 6 Click the [General] tab to make other settings.

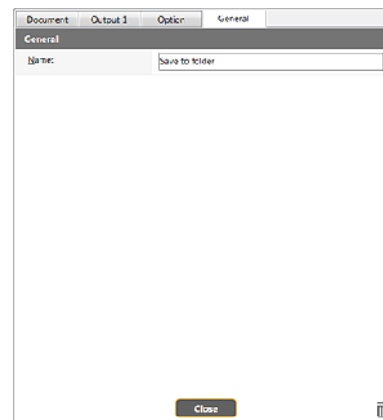

## [Name]

Enter the Scanning shortcut panel name.

## Selecting and scanning shortcuts

- 1 Place the document in the scanner. -> "Chapter 5 Placing Documents"
- 2 Click the scanning shortcut panel.

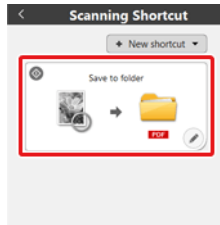

The document is scanned. While scanning is in progress, the number of pages scanned is displayed in addition to the scanner settings.

When the scan is finished, the [Scanned image preview screen] opens.

## ! CAUTION

- If you configure scanning conditions that consume a large amount of the computer's memory, scanning may stop because of insufficient memory. If an error message appears due to insufficient memory while scanning is in progress, stop scanning, change the scanning conditions, and then try scanning again.
- A multiple-page scan cannot be saved when it reaches the file size of 2 GB. Change the save settings if an error message is displayed.

## NOTE

If scanning continuously, set the next document, and click the [Scan more pages] button to start the document scan.

If [Enable additional scan] is disabled in the scanning shortcut settings, the [Scan more pages] button will not be displayed.

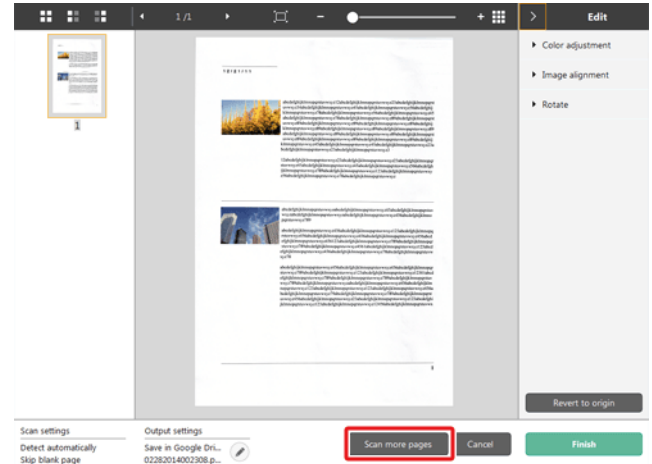

- 3 To check the scanned image, click the [Finish] button.

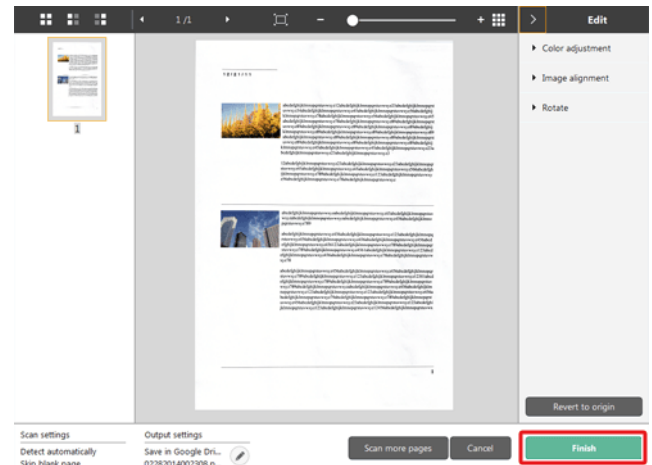

To edit scan images, see "Operations for the scanned image edit window" on p.37.



## NOTE

If [Edit after scanning] is disabled in the scanning shortcut settings, the edit window will not be displayed.

Click the [ ] button to edit the output settings. -> "Setting the output"

Click the [Cancel] button to discard the scanned image and return to the main window.

When the output has finished, a popup window will be displayed. If saving the scanned image, a link to open the save destination folder will be displayed.

This completes the shortcut scans.

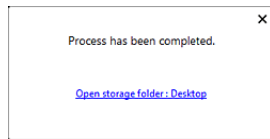

## NOTE

If you click [Open storage folder], the folder in which the saved scanned images were saved opens. Depending on the output settings, the [Open storage folder] button may not be displayed.

## Scanning with Start Button

"Scanning shortcuts" are allocated to the scanner start button in advance.

You can set frequently-used scans to the scanning shortcuts, and then allocate them to the start button.

If you place the document and press the Start button, CaptureOnTouch starts and scanning starts.

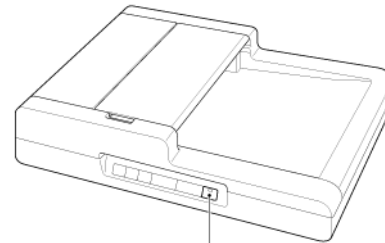

Start Button



## NOTE

- If the [Do not display the main screen when the scan is started with the scanner button] checkbox is enabled in the Environmental settings, the main CaptureOnTouch window will not be displayed when a scan is started from the start button. Only dialog boxes and error messages during scanning, and completion popup windows are displayed.
- If the [Do not display the main screen when the scan is started with the scanner button] checkbox is enabled in the Environmental settings, [Enable additional scan] and [Edit after scanning] will be disabled when scanning is started from the start button.







## Operations for the scanned image edit window

When scanning has finished, a preview window of the scanned image will be displayed.

To display the edit window in the preview window, click  on the tool bar.





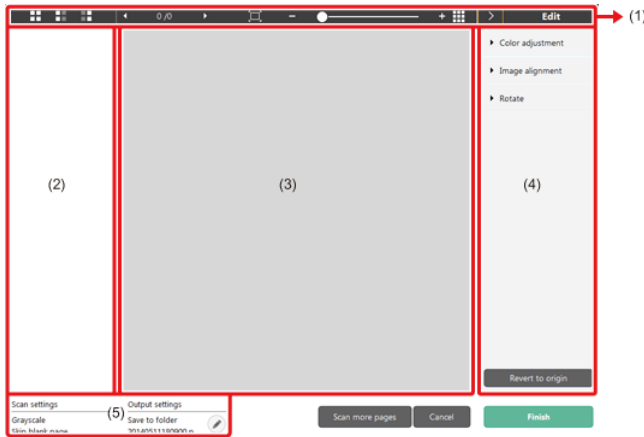

	Changes the display magnification. Move the slider to + (plus) or - (minus) to enlarge or reduce the preview image. Click  to make the display magnification of the preview enlarged to full-screen.
	Click to display or hide the preview area.
	Click  to display or hide the Edit window.

### Scanned image preview screen



#### (1)Toolbar

This tool bar enables operations to thumbnails and preview images.

Tools	Description
	Switches the image selection for the thumbnail area. These buttons mean "All pages", "Odd pages" and "Even pages" from the left.
	Indicates the page of the image displayed on the preview. Click   to change the page to be displayed.

#### (2)Thumbnail Display Area

Thumbnails of the scanned documents will be displayed. You can implement the following operations.

Click a thumbnail to display a preview of the scanned image in the preview window.

Drag a thumbnail to change pages.

#### (3)Preview Area

The preview images of scanned documents are displayed.

#### (4)Edit window

You can edit scanned documents.

Click an item to open the edit window.

Click the [Restore] button to discard the edit results and return to the previous scan image.



#### NOTE

If [Edit after scanning] is disabled in the scanning shortcut settings, the edit window will not be displayed.

## [Color adjustment] (Easy settings)

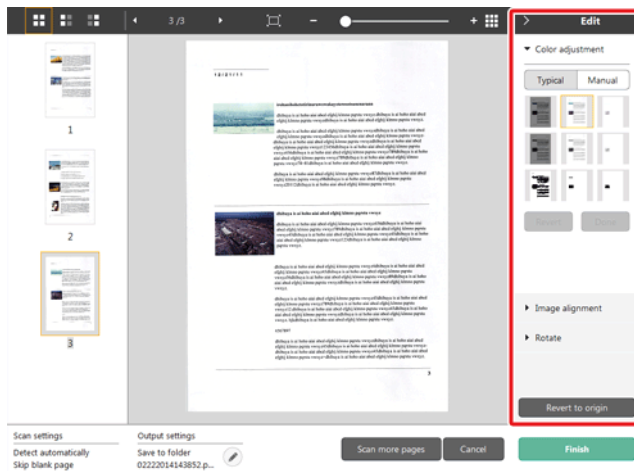

Click [Color adjustment] to display the default.

Click the button to toggle between the typical settings and manual settings displays.

Click a thumbnail in typical color adjustment to select the most suitable preview image that is displayed.

9 thumbnail patterns are displayed for the relevant image in color, and 6 patterns in grayscale.

When adjustment is finished, click the [OK] button. To cancel the adjustment, click the [Back] button.

## [Color adjustment] (Manual settings)

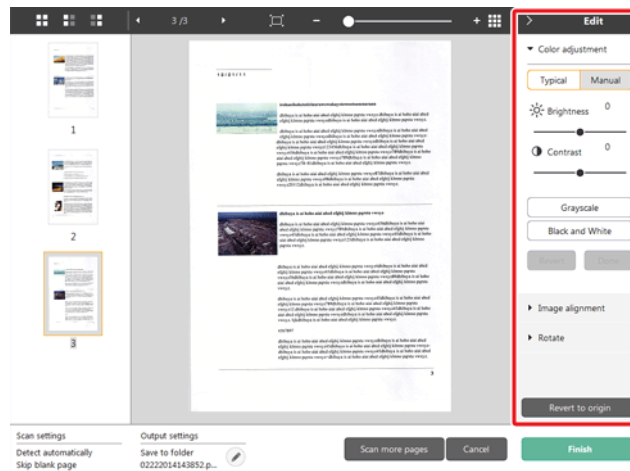

Move the slider to the left or right to adjust the brightness and contrast of the image, checking the preview image.

Click the [Grayscale] button to render the image in grayscale.

Click the [Black and White] button to render the image using 2 values: black and white.

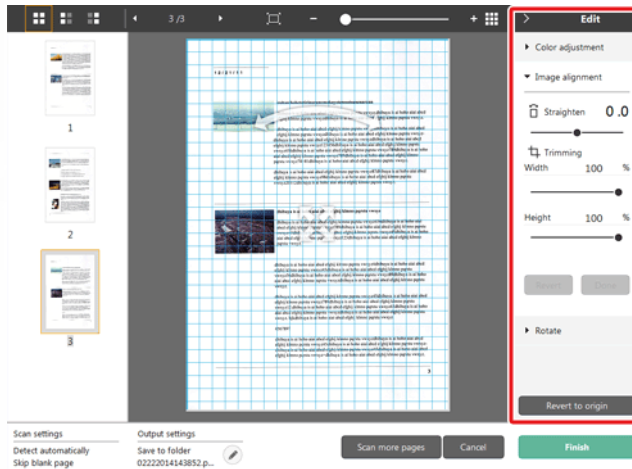

When adjustment is finished, click the [OK] button. To cancel the adjustment, click the [Back] button.

## [Image alignment]



Click [Image alignment] to display.

The preview image or the slider can be used for the straightening and the trimming.

In the preview image, drag the Move grip , the Straighten grip  and/or the trimming frame directly. To change the extent of the trimmed image, drag the Move grip  on the preview.

When adjustment is finished, click the [OK] button. To cancel the adjustment, click the [Back] button.

## [Rotate]

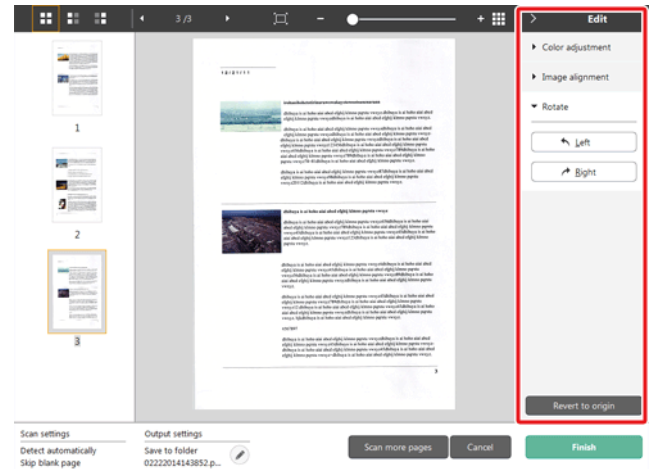

Click [Rotate] to display.

The scanned image can be rotated in 90 degrees to the left or the right. The rotation can be adjusted according to the preview image.

### (5)Information Display Area

The information regarding the "Select document" and "Select output" is displayed.

Click the  button, and the Output Settings dialog will appear. Click the [Scan more pages] button to continue the scanning. Clicking the [Cancel] button will destroy the scanned images and return to the top screen.

When clicking the [Finish] button, the output processing will start. After it is completed, the screen will return to the top screen. If saving the scanned image, a link to open the save destination folder will be displayed.



If [Enable additional scan] is disabled in the scanning shortcut settings, the [Scan more pages] button will not be displayed.

## Select document settings

By default, CaptureOnTouch enables the [Full auto] scan setting, so scanning is implemented using the scan conditions that match the document.

To specify the document size, color mode, and other settings, set the desired scan condition by editing the scan mode panel.

### Creating new [Select document] panels

Click the [New document] button, and a [New document] panel will be added.

Click  to display the list of panel types. The selected type of the panel is created.

### Edit [Select document] panel

The [Select document edit screen] opens when you click the  button in the [Select document] panel.

Click the [Select document] tab in the shortcuts editing window.



### Scan settings

Makes the scan settings.

### [Color mode]

Select the color mode for scanning from below.

Detect automatically	Automatically determines the color mode based on the document content and scans accordingly.
24-bit Color	Scans the document in color.
24-bit color (photograph)	Scans the document in color using photo-compatible tones.
Grayscale	Scans the document in Grayscale.
Grayscale (photograph)	Scans the document in color using photo-compatible tones.
Black and White	Scans the document in black and white (binary).

### [Page Size]

Select the paper size of the document to be scanned.

If you specify [Match original size], the page size of the scanned document is detected and the images are saved at the detected size.

### [Dots per inch]

Select the resolution.

Select [Detect automatically] and the software will automatically scan the document at the optimum resolution.

### [Scanning Side]

Select the scanning side of the document.

If you select [Skip blank page], scanned images of blank pages are not saved.

### [Automatically straightens skewed images]

If a document is not straight when fed, the scanner detects that the document is not straight from the scanned image and straightens the skewed image.

Select the setting from below.

[OFF]

[Straightens with angle of fed documents]

[Straightens with angle contents of fed documents]

### [Rotate image to match orientation of text]

Check [Enable] on to rotate the image in the same direction with the characters.

### [Use advanced settings dialog box]

Document scan settings include basic items that are configured in [Scan settings], and the settings that are configured in the advanced settings dialog box. The settings in the advanced settings dialog box are applied for settings other than the basic items.

Enable [Use advanced settings dialog box] to implement advanced scanner settings other than the basic items using the advanced settings dialog box (scanner driver). To open the scanner driver, enable this item, and then click the [Settings] button.



### NOTE

The driver settings dialog box includes setting items that are the same as the basic items in [Scanner setting], but the setting for each of the them is stored separately.

Which settings are used during scanning differs as follows depending on the setting of the [Use advanced settings dialog box] check box.

Setting of [Use advanced settings dialog box]	Basic items	Other than basic items
OFF	Settings of [Scanner setting]	Settings of the advanced settings dialog box of the scanner driver
ON	Settings of the advanced settings dialog box of the scanner driver	

For the advanced settings other than the basic items, see the help in the driver settings dialog box.

### General

Set the following items as occasion demands.

#### Name

Enter the name to be displayed in the select document panel.

### Icon

You can change the document scan icon displayed in the select document panel and scanning shortcut panel.

Enable [Change icon] to enable the [Settings] button and select the file.

The file formats that can be selected as icon files are described below.

- .ico, .exe, .jpg, .png

## Setting the output

By default, CaptureOnTouch enables the settings to convert the scanned images to PDF file and save to a folder.

To specify the output method and save location, edit the output panel and set the desired output.

### Create new [Output] panel

Click the [New output] button to add a [New output] panel.

Click  to display the list of panel types. The selected type of the panel is created.

### Edit [Output] panel

The Edit output screen opens when you click the  button in the Output panel.

Click the [Output] tab in the shortcuts editing window.

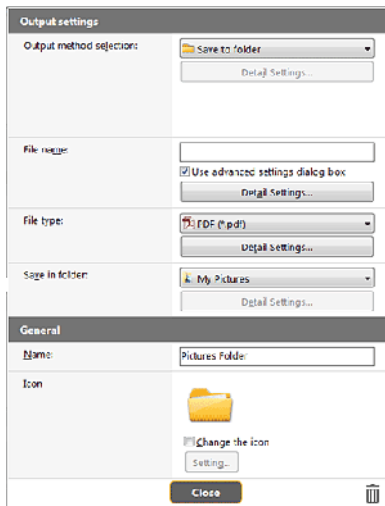

### Select output method

File formats and save locations that can be selected depend on the output method selected.

## Save to folder

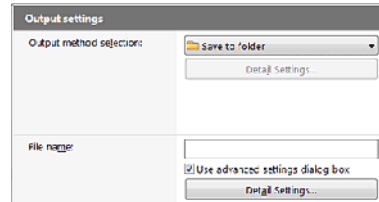

Saves the scanned image to the specified folder. When this output method is specified, set the save location folder.

## Other output methods

CaptureOnTouch supplies output methods other than [Save to folder] as plugins.

By installing the plug-in, you can use various services such as printing the scanned image or attaching it in an e-mail.

To install plugins, enable the checkbox when installing CaptureOnTouch.

The output methods that can be selected depend on the plugins that have been installed.

For how to use the plugins, see the plugin help.

## Scanning Shortcut setting

By default, CaptureOnTouch enables the [Full auto] scan setting, so scanning is implemented using the scan conditions that match the document.

To specify combinations of document selection and outputs, you can edit the scanning shortcut panel to set the desired scanning shortcut.

### Creating new [Scanning Shortcut] panels

There are two ways as described below to create a new Scanning Shortcut panel.

- Click the [Save to Shortcut] button in [3 actions] in Standard Scanning to register the selected output and document scan to one of the scanning shortcut panels.
- Click the [New shortcut] button to add [New scanning shortcut] panel.  
Click  to display the list of panel types. The selected type of the panel is created.

### Editing new [Scanning Shortcut] panels

When the Edit button  is clicked, the Scanning Shortcut panel editing dialog will appear.

The following tabs are on the Edit Scanning Shortcut panel screen.

- [Document] tab
- [Output] Tab
- [Option] Tab
- [General] Tab

## About file formats

Set the file format of the scanned image. When you select a file format other than BMP or PNG, the [Detail Settings] button is enabled, allowing you to make the detail settings for the selected file format.



### NOTE

You can select one of the following file formats for the scanned image.

- PDF format
- TIFF format
- PNG format
- JPEG format
- BMP format
- PPTX format (File format for Microsoft PowerPoint 2007 and later)

The file formats that can be selected vary depending on the destination setting.

When you output the scanned image using the plug-in, the image is output in the file format set in the application of the plug-in.

Therefore this file format may be different from the one selected in the Select document panel.

### PDF setting

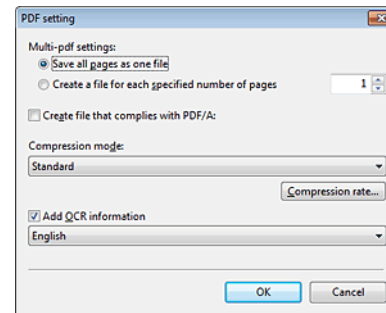

In [Multi-pdf settings], specify whether to save the scanned images as a multi-page file ([Save all pages as one file]) or single page files ([Create a file for each specified number of pages]).

For [Create file that complies with PDF/A], select [ON]. For [Compression mode] select either [Standard] or [high compression].

If you click the [Compression rate] button, you can specify the compression rate in the dialog box that appears.

## PPTX settings

## TIFF setting

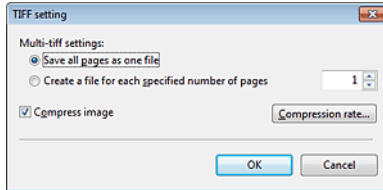

In [Multi-tiff settings], specify whether to save the scanned images as a multi-page file ([Save all pages as one file]) or single page files ([Create a file for each specified number of pages]).

**By selecting ON for [Compress image] and clicking the [Settings] button, you can specify the compression rate in the dialog box that appears.**

## JPEG setting

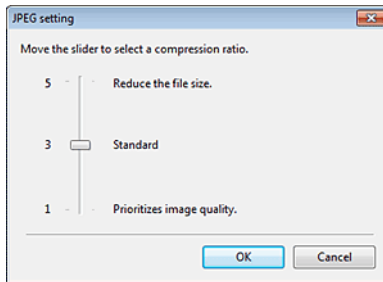

You can specify the compression rate of JPEG images.

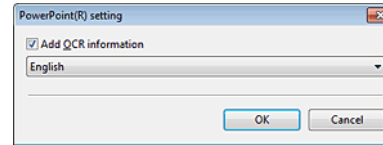

You can specify whether to add OCR information to the scanned images.



## Environmental Settings

To configure the environmental settings of CaptureOnTouch, open the [Environmental settings] dialog box.

Click  (CaptureOnTouch icon) in the taskbar, and select [Environmental settings] from the menu.

The following describes the setting items of each tab displayed in the [Environmental settings] dialog box.

### [Basic settings] Tab

On the [Basic settings] tab, configure the following settings.

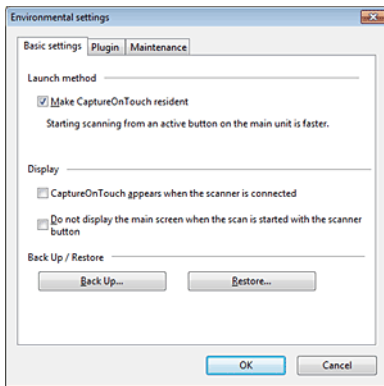

### Launch method setting

By default, CaptureOnTouch becomes resident in the system when you start your computer. Clear the [Make CaptureOnTouch resident] check box to not make CaptureOnTouch resident in the system.

### Display

Select the [CaptureOnTouch appears when the scanner is connected] checkbox to open the main screen of CaptureOnTouch automatically when the scanner is connected to the computer. This setting is only enabled when CaptureOnTouch is running (or resident in the system).

When this setting is enabled, the [Do not display the main screen when the scan is started with the scanner button] setting is disabled.

If the [Do not display the main screen when the scan is started with the scanner button] check box is selected, the main screen of CaptureOnTouch is not displayed when the Scanning Shortcut scanning is started by pressing the scanner's Start button. However, dialogs and error messages during scanning and the pop-up screen when the scan is completed will be displayed.

When this setting is enabled, the [Enable additional scan] and [Edit after scanning] check boxes on the Edit Scanning Shortcut settings screen are disabled.

### Back Up / Restore

Use the [Back Up] and [Restore] buttons to back up the configuration file (settings, registered jobs, etc.) of CaptureOnTouch and restore the settings from the backup data.

### [Back Up] button

Back up the settings of CaptureOnTouch to a backup file (\*.cot). You can store the initial settings of CaptureOnTouch by performing a backup before you first use CaptureOnTouch.

### [Restore] button

Restore the settings from the backup file.

When using multiple computers, you can back up the environmental settings of one computer and then perform a restore on the other computers so that all of the computers have the same settings.

## [Plugin] Tab

On the [Plugin] tab, confirm the plugins that have been added to CaptureOnTouch.

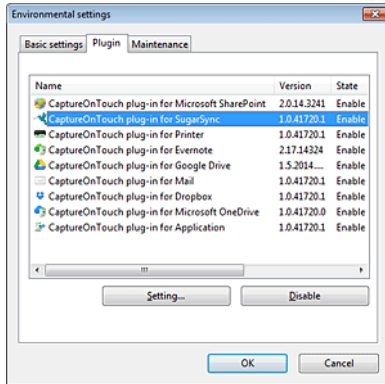

## [Maintenance] Tab

On the [Maintenance] tab, you can configure the log settings for the maintenance of CaptureOnTouch and initialize the settings.

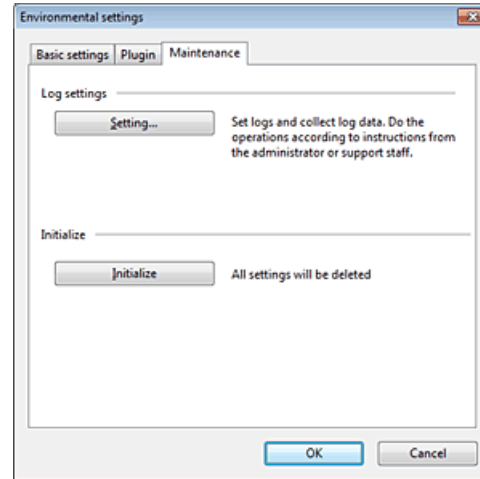

## [Setting] button

Displays the detailed information on the selected plugins.



**NOTE**

This button may not be displayed for some plugins.

## [Enable] [Disable] button

This button is used to toggle between Enable/Disable modes for the plugin selected from the plugin list.

If you click the [Disable] button, the following dialog is displayed.

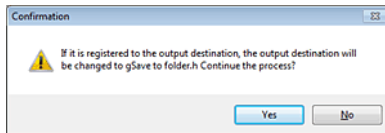

## Log settings

The Log file settings screen opens when you click the [Settings] button.

Select the type of log file.

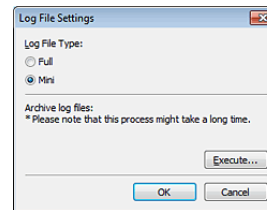

If you click the [Execute] button, the [Save File] dialog is displayed.

The operation slows down if you select [Full] for [Log file type].

## [Initialize]

A confirmation dialog box appears when you click the [Initialize] button.

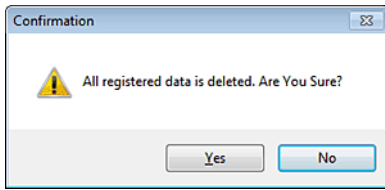

All CaptureOnTouch data are deleted and returned to the default settings.

## Chapter 7 Setting the Scanner Driver

When you scan a document in an ISIS compatible or TWAIN compatible application (CaptureOnTouch, etc.), open the scanner driver and configure the scanning conditions and other settings.

This section describes the configuration and functions of the scanner driver.

Configuration and Functions of the Scanner Driver.....	48
Setting Basic Scanning Conditions.....	50

## Configuration and Functions of the Scanner Driver

The scanner driver consists of the following five tabs.



### NOTE

For details on the setting screen, see the Help of the scanner driver. Click the [Help] button of the driver to display help related to the corresponding tab or dialog box.

### [Basic] Tab

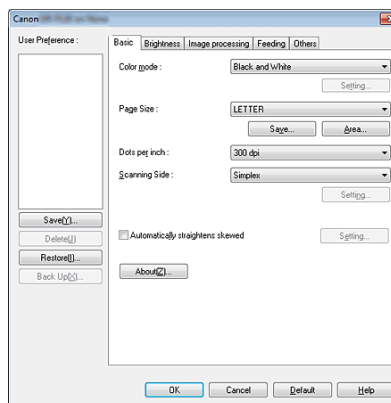

Configure basic scanning conditions such as the mode, page size, resolution, and scanning side.

In addition, you can click the [Area] button and specify the area to be scanned.



### NOTE

Depending on the ISIS compatible application, the application may have its own screen for setting scanning conditions. If the scanner driver is opened in such an application, setting items related to the functions provided by the scanner driver other than scanning conditions will be displayed on the [Basic] tab.

## [Brightness] Tab

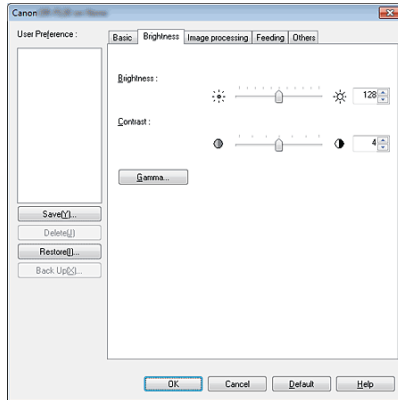

Adjust the brightness and contrast of scanned images. In addition, you can also click [Gamma] and set the gamma correction value for scanned images.



### NOTE

- Gamma correction is set when the color tone of the scanned image is different from that of the image displayed on the monitor.
- For information on your monitor's gamma value, see the instruction manual that came with the monitor.

## [Image processing] Tab

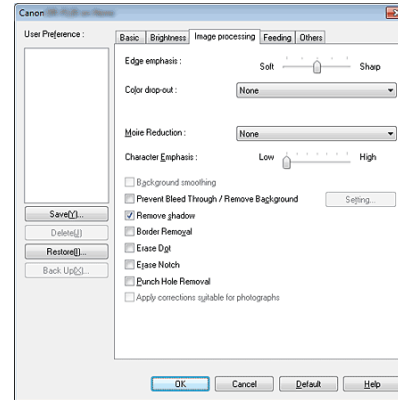

Set the processing method for scanned images.

## [Feeding] Tab

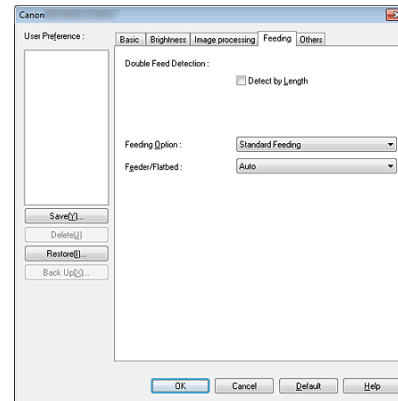

Specify scanner operations related to document feeding.

[Others] Tab

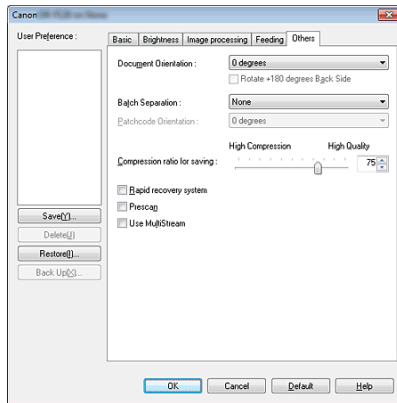

Configure settings for specialized scanning and image processing.

## Setting Basic Scanning Conditions

This section provides an overview of the basic setting items that are the minimum requirements when configuring the scanner settings.

### Confirming Basic Conditions for Scanning

When you scan a document, make sure you confirm the [Color mode], [Page Size], [Dots per inch], and [Scanning Side] basic conditions in the Basic settings dialog box.

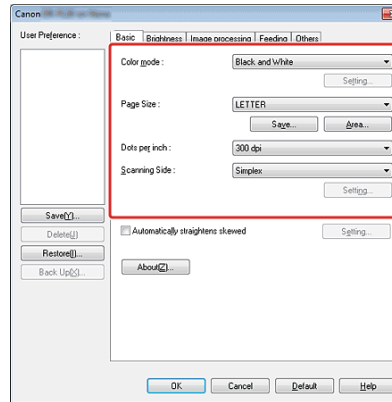

### Color mode

Select the scanning mode.

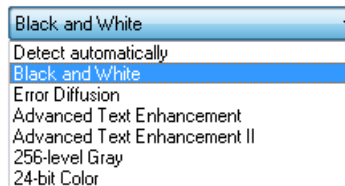

- [Advanced Text Enhancement] and [Advanced Text Enhancement II] remove or process the background color and background surrounding text to enhance the text for easy reading. When [Advanced Text Enhancement II] is selected, you can

make the text in scanned images easier to read by adjusting the contrast on the [Brightness] tab.

- [Detect automatically] detects whether the document is in color, grayscale, or black and white. You can configure advanced settings related to the detection method by clicking [Setting]. For details, see the Help.

## Page Size

Select the page size that matches the document to be scanned.



If [Match original size] is selected, the edges of the document are detected and images that match the size of the document are saved.



### NOTE

If [Auto-detection] is selected, the edges of the document are detected, and images are saved according to the detected document size.

## Dots per inch

Select the scanning resolution.

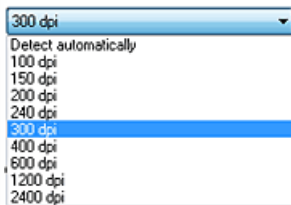

Higher resolutions provide clearer images but result in larger file sizes and slower scanning.

When [Detect automatically] is specified, the resolution is detected automatically from the content printed in the document.

## Scanning Side

Select which of the sides of the document to scan.

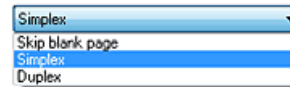

If the scanning side is set to [Skip Blank Page], the images of blank pages are deleted when images are saved.

## [Feeder/Flatbed]



Specify whether to scan documents using the feeder or the flatbed.

If [Auto] is selected, scanning occurs from the feeder only when documents are placed in the feeder. (If there are no documents in the feeder, the documents placed on the flatbed are scanned.)



### NOTE

- To scan using the flatbed, set [Feeder/Flatbed] to [Flatbed] or [Auto].
- If [Feeder/Flatbed] is set to [Auto], documents placed in the feeder are scanned. If there are no documents in the feeder, the documents placed on the flatbed are scanned.
- This setting is automatically set to [Feeder] when [Rapid recovery system] is enabled in the [Others] tab.

## Chapter 8 Special Scanning

## Practical Examples

This section provides examples of scanning settings for different purposes. For details on setting options, see "Chapter 7 Setting the Scanner Driver" on p.48.

### Practical Examples

To scan unregistered size documents .....	52
When you want to specify the scan area.....	53
When you want to delete the images of the blank pages in two-sided documents .....	53
When you do not want to scan colored lines and text .....	53
When you want to enhance a particular color .....	54
When you want to enhance contours in images.....	54
When you want to eliminate black borders around scanned images.....	54
When you want to make lines or characters in the scanned images thicker .....	54
When you want to enhance text that is difficult to read because of factors such as the background of the scanned document .	55
To correct tilted documents and images.....	55
When you want to remove the black spots in scanned images while scanning documents with punch holes .....	55
When you want to detect multiple pages fed at the same time	56
When you want to match the orientation of images to the text when scanning a mixture of pages with different text orientations	56
When you want to rotate the images of a document placed horizontally to correct the orientation .....	57
When you want to use multistream settings for scanning .....	57
When you want to remove dots and notches that appear in documents.....	58
When you want to save a scanner driver setting .....	59
Function Restrictions Depending on Mode Setting.....	59

### To scan unregistered size documents

You can register a non-standard page size that has not been registered as a page size by naming and registering it as a custom page size in the Custom Paper Size dialog box, which is opened from the [Save] button on the [Basic] tab.

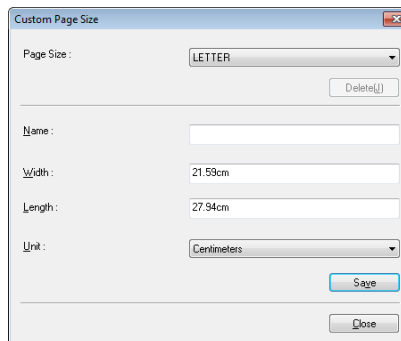



## Practical Examples

### When you want to specify the scan area

Specify the area of the document to be scanned in the Scan Area dialog box, which is opened from the [Area] button on the [Basic] tab.

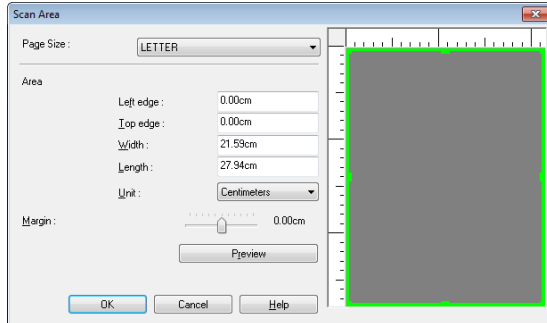

## Practical Examples

### When you want to delete the images of the blank pages in two-sided documents

Set the scanning side setting to [Skip Blank Page] on the [Basic] tab to delete the images of the blank pages in the document.

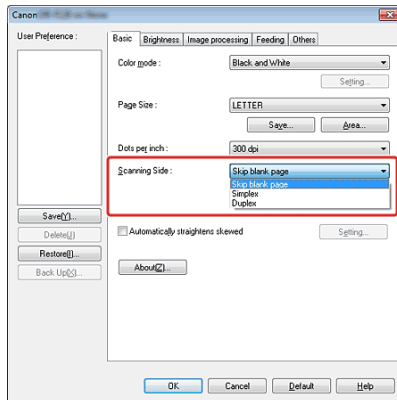

If [Skip Blank Page] is selected, the [Setting] button is enabled, and you can adjust the level for judging whether pages are blank.

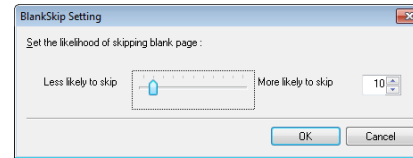

## Practical Examples

### When you do not want to scan colored lines and text

Specify the color (red, blue, green or Color Elimination) to be ignored (dropped out) in the color drop-out settings on the [Image processing] tab, and that color will not be scanned.

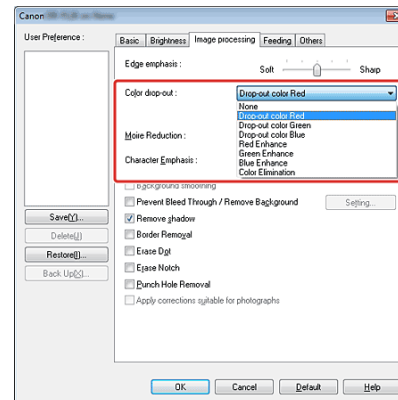

## Practical Examples

### When you want to enhance a particular color

Specify the color to enhance (red, blue, or green) from the [Color drop-out] drop-down list in the [Image processing] tab.

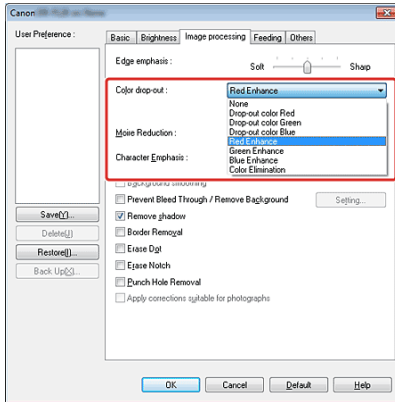

## Practical Examples

### When you want to eliminate black borders around scanned images

Select the [Border Removal] check box in the [Image processing] tab. The black borders that surround scanned images are removed.

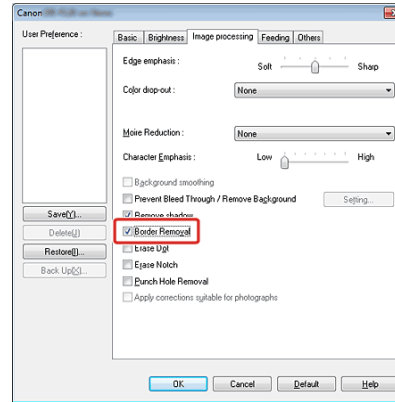

## Practical Examples

### When you want to enhance contours in images

Adjust the edge emphasis setting on the [Image processing] tab.

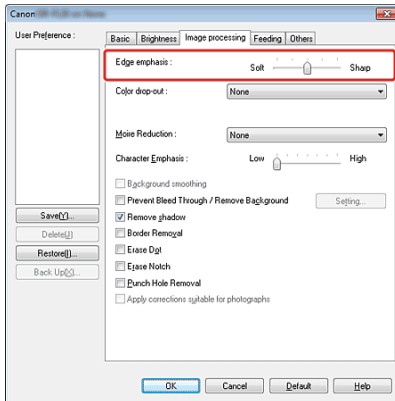

## Practical Examples

### When you want to make lines or characters in the scanned images thicker

Drag the slider for [Character Emphasis] on the [Image processing] tab to make the lines and characters that appear in the scanned image thicker.

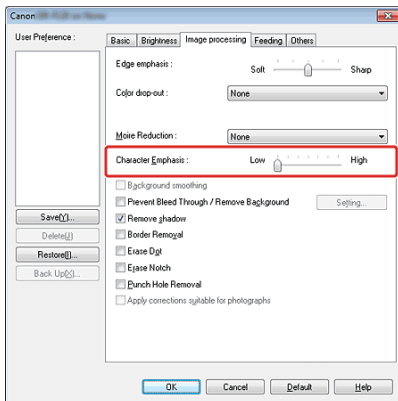

## Practical Examples

### When you want to enhance text that is difficult to read because of factors such as the background of the scanned document

Select [Advanced Text Enhancement] or [Advanced Text Enhancement II] in the mode setting on the [Basic] tab. The background behind the text is removed or processed so that the text is emphasized for better readability.

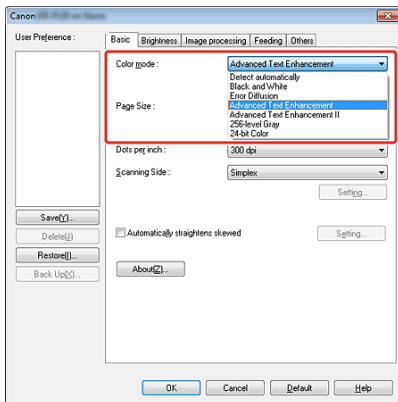

- Advanced Text Enhancement is suitable for a document with a light background color or a document with a non-uniform background (such as a pattern). If the background is uniform, it is removed where it surrounds the text, and if the background is non-uniform, it is processed to enhance text readability.
- Advanced Text Enhancement II is suitable for scanning a document with a uniform background color and light text and background. If the background is non-uniform, such as a pattern, the background may not be able to be completely removed and the text may become difficult to read. If necessary, you can make the text in scanned images easier to read by adjusting the contrast on the [Brightness] tab.

## Practical Examples

### To correct tilted documents and images

Place a check in [Automatically straightens skewed] under the [Basic] tab, and then click [Setting] to display the [Deskew Settings] screen.

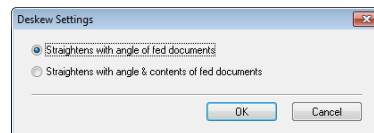

Select a correction method and click [OK].

## Practical Examples

### When you want to remove the black spots in scanned images while scanning documents with punch holes

Select the [Punch Hole Removal] check box in the [Image processing] tab. The black spots from the punch holes in the document are removed from scanned images.

## Practical Examples

**When you want to match the orientation of images to the text when scanning a mixture of pages with different text orientations**

Select [Text orientation recognition] in [Document Orientation] on the [Others] tab. The text orientation on each page is detected, and the scanned image is rotated in 90-degree increments to correct the orientation.

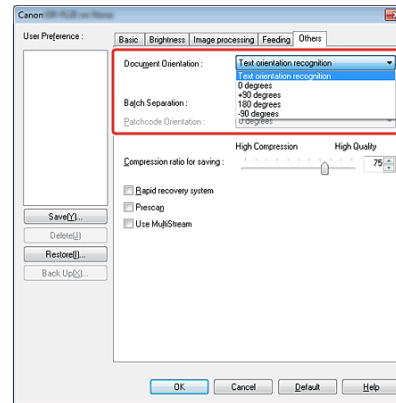

The orientation of the text is detected on each page, and each scanned image is rotated in 90-degree increments to the correct orientation.

Flatbed Document: Face down				
Feeder Document: Face up				
Output image				

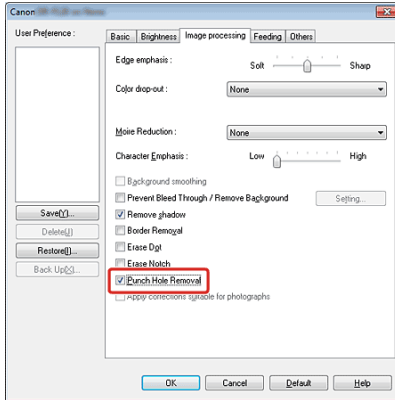

## Practical Examples

**When you want to detect multiple pages fed at the same time**

Select the [Double Feed Detection] check box on the [Feeding] tab. You can enable the [Detect by Length].

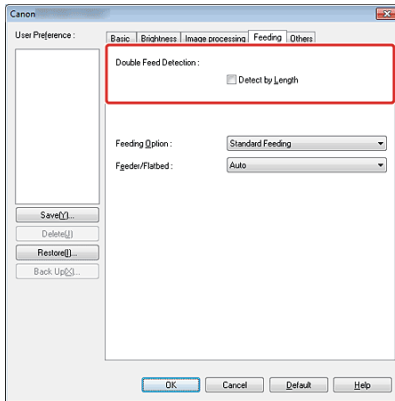



## NOTE

When the [Text Orientation Recognition] check box is selected, the [Document Orientation] drop-down list is disabled.

## Practical Examples

### When you want to rotate the images of a document placed horizontally to correct the orientation

Specify the rotation angle in [Document Orientation] on the [Others] tab.

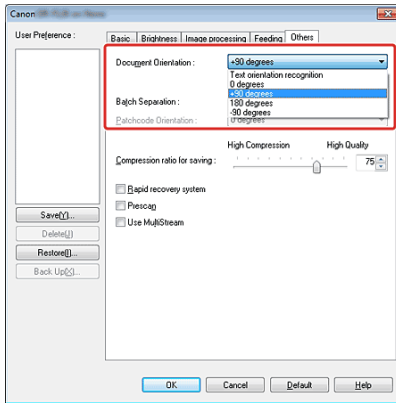

## NOTE

Images are rotated according to the orientation of the loaded document and the selected angle.

Flatbed Document: Face down				
Feeder Document: Face up				
Image rotation (clockwise)	0 degrees	90 degrees	180 degrees	270 degrees

Output image				
--------------	--	--	--	--

## Practical Examples

### When you want to use multistream settings for scanning

Multistream settings allow you to output multiple different scanned images with a single scan operation, and output scanned images with different scanning conditions for each of the front and back pages.



**CAUTION**  
Depending on the application program, these settings may not appear.

When you want to use the multistream settings for scanning, select the [Use MultiStream] checkbox on the [Others] tab to display the setting items related to multistream, and then configure the setting items in the following order.

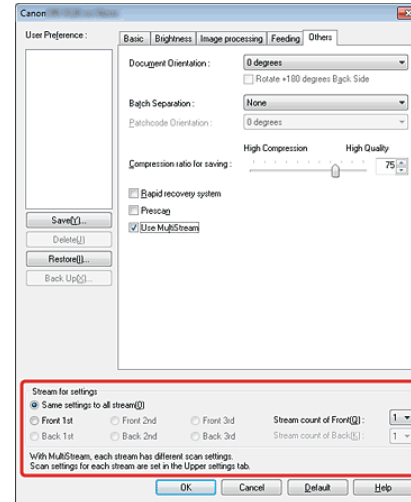

- 1 When you want to specify different scanning conditions for the front and back pages of a document, select [Skip Blank Page] or [Duplex] for [Scanning Side] on the [Basic] tab in advance.
- 2 Specify the number of scanning conditions to apply in [Stream count of Front]. Up to three can be specified.
- 3 Select [Front 1st], and then open the other tabs and set the scanning conditions.

Depending on the value specified for [Stream count of Front], configure the remaining [Front 2nd] and [Front 3rd] in the same way.

- 4 When specifying the scanning conditions of the back, configure the settings in the same way as described in 2 to 3.

In this case, specify [Stream count of Back], and then set the scanning conditions for each of [Back 1st] to [Back 3rd].



## NOTE

The following shows the setting conditions that can be set in the multistream settings.

Tab	Items that can be set
[Basic] tab	[Color mode] and [Dots per inch] (excluding [Detect automatically] for both)
[Brightness] tab	[Brightness] and [Contrast]
[Image processing] tab	[Edge emphasis], [Color drop-out] and [Character Emphasis]
[Feeding] tab	None (all disabled)
[Others] tab	None (only [Use MultiStream] is enabled)

## Practical Examples

### When you want to remove dots and notches that appear in documents

You can remove dots and notches protruding from object outlines that appear in documents from scanned images.

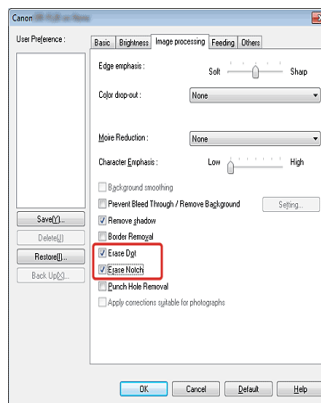

- Select the [Erase Dot] check box to automatically remove isolated black dots (3 x 3 dot size) from white backgrounds (or white dots from black backgrounds).
- Select the [Erase Notch] check box to remove notches that protrude from object outlines in scanned images.

## Practical Examples

### When you want to save a scanner driver setting

When you finish configuring a setting, click the [Save] button of [User Preference] to save the setting.

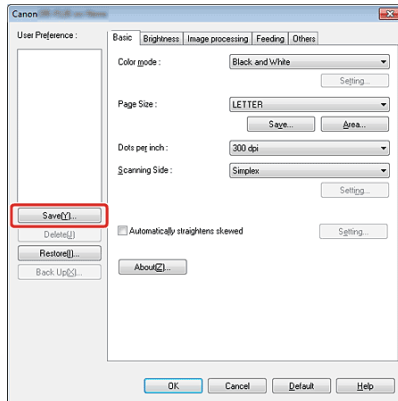

The saved setting is registered to the list. You can delete a setting from the list with the [Delete] button, and save or load a configuration file with the [Back Up] or [Restore] button.



### NOTE

The preregistered [Full Automatic Mode] cannot be deleted from [User Preference].

## Function Restrictions Depending on Mode Setting

Some of the setting items in each of the driver tabs are disabled as follows depending on the setting for [Color Mode] on the [Basic] tab.

### [Brightness] tab

Setting value	Contrast
Detect automatically	○
Black and White	○
Error Diffusion	○
Advanced Text Enhancement	—
Advanced Text Enhancement II	○
256-level Gray	○
24-bit Color	○

○: Available for setting —: Not available for setting

### [Others] Tab

Setting value	Prescan
Detect automatically	—
Black and White	○
Error Diffusion	○
Advanced Text Enhancement	○
Advanced Text Enhancement II	○
256-level Gray	○
24-bit Color	○

○: Available for setting —: Not available for setting

## [Image processing] tab

Setting value	Edge emphasis	Color drop-out	Background smoothing
Detect automatically	O	–	O
Black and White	O	O	–
Error Diffusion	O	O	–
Advanced Text Enhancement	O	O	–
Advanced Text Enhancement II	–	O	–
256-level Gray	O	O	O
24-bit Color	O	–	O

Setting value	Prevent Bleed Through / Remove Background	Character Emphasis
Detect automatically	O*1	O*2
Black and White	O	O
Error Diffusion	O	O
Advanced Text Enhancement	–	O
Advanced Text Enhancement II	–	O
256-level Gray	O	–
24-bit Color	O	–

O: Available for setting –: Not available for setting

\*1 Not available for setting if all of the following conditions in the [Auto Image Type Detection Settings] dialog box are met.

- [Detection mode] is not set to [Color or Gray]
- [Mode in case of binary] in the [Settings for in case of binary] tab is set to [Advanced Text Enhancement] or [Advanced Text Enhancement II]

\*2 Not available for setting when [Detection Mode] is set to [Color or Gray] in the [Auto Image Type Detection Settings] dialog box.



## Chapter 9 Regular Maintenance

Clean the scanner and perform maintenance on a regular basis as described below to maintain peak scanning quality.

Routine Cleaning .....	61
Cleaning the Roller Unit and Retard Roller .....	63
Adjusting the Reduction Ratio .....	66
Auto Power Off Setting .....	67

### CAUTION

- When cleaning the scanner and inside of the feeder, be sure to turn off the power and disconnect the power plug from the outlet beforehand.
- Do not use spray cleaners to clean the scanner. Precision mechanisms, such as the light source, may get wet, and cause a malfunction.
- Never use paint thinner, alcohol, or other organic solvents to clean the scanner. Such solvents can damage or discolor the exterior of the scanner, or create a risk of fire or electrical shock.

## Routine Cleaning

Clean the scanner on a regular basis to maintain scanning performance.

### WARNING

- For safety, always turn the power switch OFF and disconnect the power cord before cleaning the scanner and the inside of the feeder.
- Do not use spray-type cleaners to clean the scanner. Precision mechanisms may get wet and malfunction.
- Never use paint thinner, alcohol, or other solvents to clean the scanner. Doing so may deform, discolor, or dissolve surfaces, or result in a fire or electric shock.

### Cleaning the Scanner

Use a cloth dampened with water and thoroughly wrung out to clean the outside of the scanner, and use a clean dry cloth to wipe the scanner dry.



### Cleaning the Scanning Glass and Pressure Board

If your scanned images contain lines or smudges, or if the scanned documents are dirty, then the scanning glass or the Pressure Board inside the scanner may be dirty. Clean them periodically.

- 1 Carefully open the feeder.

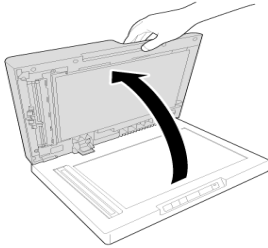

- 2 Use a clean dry cloth to wipe dirt off of the scanning glass and the platen glass. There are two scanning surfaces, the flatbed (platen glass) and scanning glass for scanning documents fed from the feeder. Make sure to clean both surfaces.

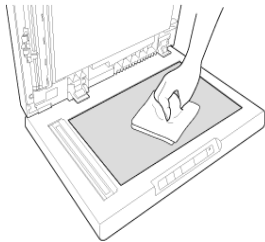

- 3 Wipe the Pressure Board with a clean dry cloth.

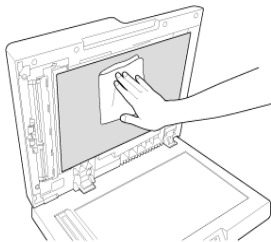

- 4 Use a clean dry cloth to wipe off smudges from the white transparent film.

The white transparent film is used in two locations: Left side of the pressure board and film area that appears when you pull open with a thumb hook, as shown in the figure.

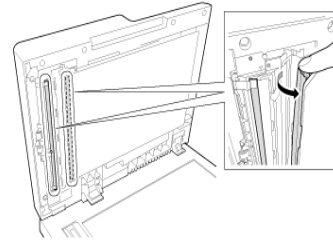

- 5 Carefully close the feeder.

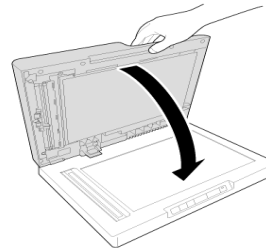

## CAUTION

Close the feeder gently to avoid catching your hands, as this may result in personal injury.

## Cleaning the Roller Unit and Retard Roller

If streaks appear in scanned images, or if scanned documents become dirty, the roller unit and retard roller may be dirty. Be sure to clean them regularly.



### NOTE

The roller unit and retard roller are located inside the feeder cover. Be sure to remove the roller unit and retard roller, as shown below, before cleaning them.

### Removing the Roller Unit and Retard Roller

- 1 Open the document feed tray and feeder cover.

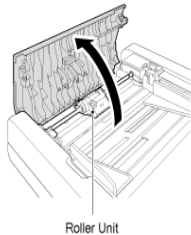

- 2 Raise the roller unit's lock lever. (Gently bend the lock lever inward, then raise it.)

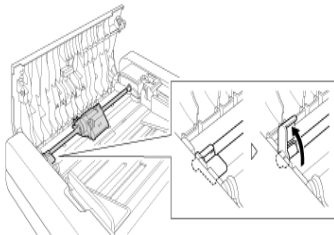

- 3 Remove the roller unit.

Hold the center of the roller unit (roller portion), lift the lock lever side (A), then the other side (B).

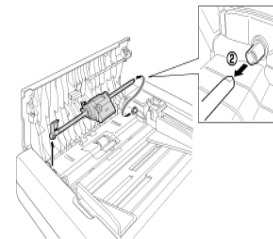
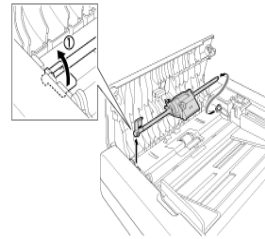

- 4 Put your finger in the thumb hook, as shown in the figure, and open the cover in the direction of the arrow.

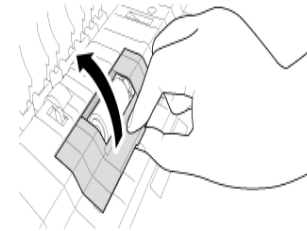

- 5 Push the retard roller to the right to separate it from its axis and remove it.**

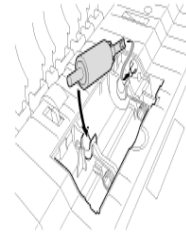
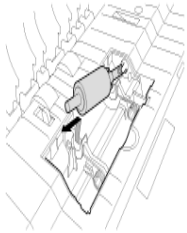

- 2 Close the cover.**

Check that you hear a clicking sound and the roller is pushed in completely.

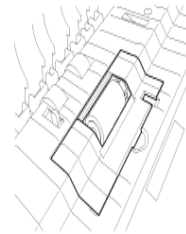
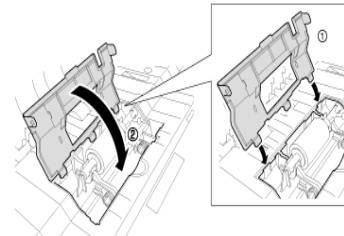

- 3 Attach the roller unit.**

Insert the shaft pin of the roller unit into the notch on the scanner (A), and attach the lock lever vertically (B).

- 6 Use a cloth dampened with water and thoroughly wrung out to wipe the roller clean.**

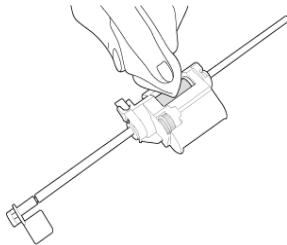

## Attaching the Roller Unit and Retard Roller

- 1 Attach the Retard Roller.**

Set the retard roller in the recess inside the roller cover. Make sure the roller's notch is aligned with the axis on the front unit, and then push the roller further into the recess.

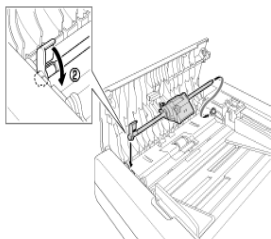
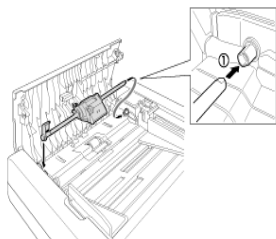

- 4 Lower the lock lever to secure the roller unit into place. You can lower the lock lever smoothly by gently bending it inward.**

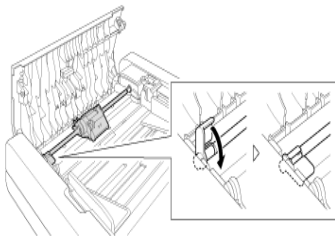

- 5** Lose the feeder cover and document feed tray.

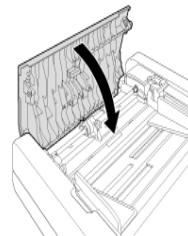

### CAUTION

When closing the feeder cover and document feed tray, be careful not to get your fingers caught, as this may result in personal injury.

### IMPORTANT

The roller unit and retard roller are consumable parts. If performance does not improve after cleaning the roller unit and retard roller, the parts may need to be replaced. Contact your local authorized Canon dealer. When replacing the parts, first replace the retard roller. If performance does not improve, replace the roller unit as well.

## Adjusting the Reduction Ratio

As the rollers installed in the scanner wear out, scanned images may become stretched in the vertical direction. If this happens, you can reduce the amount of stretching of the image by adjusting the reduction ratio.



### IMPORTANT

Log on to Windows as an Administrator.

- 1 Click the Start button, and then click [All Programs], [Canon DR-F120], and [Canon imageFORMULA Utility].

imageFORMULA Utility starts.

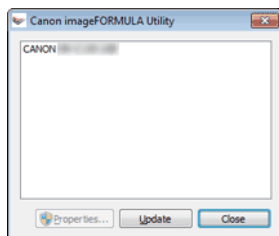

### NOTE

In Windows 8.1/8, it is registered at the following location.

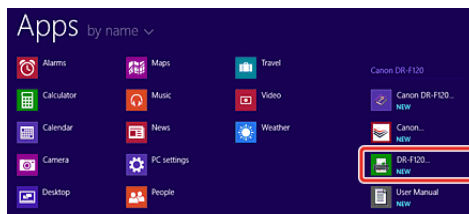

- 2 Click [CANON DR-F120 USB] and click [Properties].

Scanner properties are displayed.

- 3 Change the value of [Reduction ratio adjustment].

The adjustment value can be set within the range from -3.0% to 3.0%.

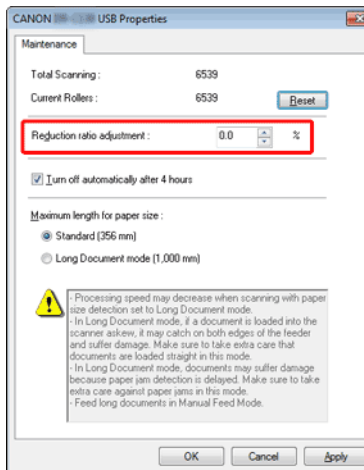

- 4 Click [OK] to close the scanner properties.

## Auto Power Off Setting

The scanner automatically turns off if 4 hours elapse without scanning or another operation being performed.  
To disable this setting, follow the procedure below.



### IMPORTANT

Log on to Windows as an Administrator.

- 1 Click the Start button, and then click [All Programs], [Canon DR-F120], and [Canon imageFORMULA Utility].  
imageFORMULA Utility starts.

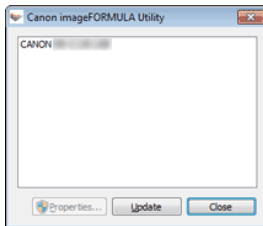

### NOTE

In Windows 8.1/8, it is registered at the following location.

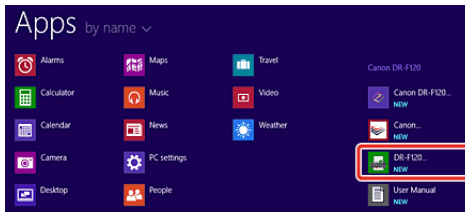

- 2 Click [CANON DR-F120 USB] and click [Properties].  
Scanner properties are displayed.

- 3 Clear the [Turn off automatically after 4 hours] check box.

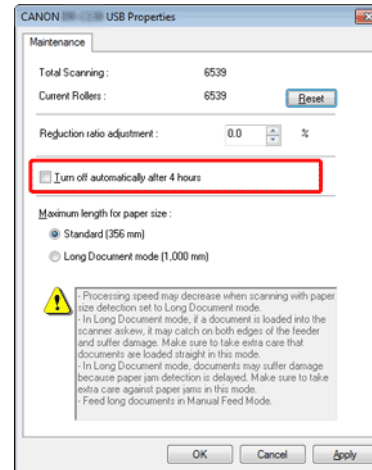

- 4 Click [OK] to close the scanner properties.

## Chapter 10 Uninstalling the Software

If the scan driver or CaptureOnTouch is not operating normally, follow the procedure below to uninstall them. Then, re-install the software from the Setup disk. -> "Software Installation" on p.17

Uninstallation ..... 68

### Uninstallation

---



#### IMPORTANT

Log on to Windows as an Administrator.

**1 From the Windows task bar, click the [Start] button, and then [Control Panel].**

**2 Click [Uninstall a program] ([Add or Remove Programs] for Windows XP).**

The [Uninstall or change a program] dialog box appears.

**3 From the Programs list, select the software you want to remove and then click [Remove].**

The delete confirmation screen appears.

**4 Click [Yes].**

Uninstallation of the software is now complete.



## Chapter 11 Troubleshooting

Clearing a Paper Jam .....	69
Common Problems and Solutions .....	70
Useful tips .....	72

### Clearing a Paper Jam

When paper jams occur during scanning, use the following procedure to clear them.



**When removing jammed paper, take care not to cut your hands on the edges of the paper.**

- 1 Remove any documents from the document feed tray and the document eject opening.**

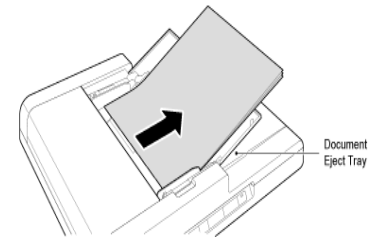

- 2 Open the feeder cover to check for jammed paper.**

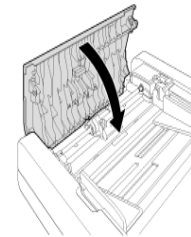

If there is no jammed paper inside the feeder cover, check the back of the feeder and the document eject opening.

- 3** If the jammed document is skewed or ripped, carefully remove it manually. Take care not to rip the paper.



## IMPORTANT

Make sure to pull the document out carefully, without applying too much force. If the jammed paper tears while you are pulling it out, make sure to remove any remaining pieces from inside the scanner.

- 4** Carefully close the feeder cover until it clicks into place



## NOTE

- After removing the jammed paper, check to see if the last page was scanned correctly, and then continue scanning.
- When a paper jam or other problem occurs while [Rapid recovery system] is enabled in the scanner driver, the image of the last document that was scanned properly is saved before scanning is stopped. Therefore, you can quickly resume scanning after resolving the cause of the interruption. As the image of the document that was being fed at the time of the interruption may not be saved in such cases, be sure to verify the last scanned image before resuming the operation.

## Common Problems and Solutions

---

This section provides recommended solutions to common problems.

If you have a problem that is not solved by the following, contact your local authorized Canon dealer.

---

### Q1 The scanner will not turn on.

- A1 Confirm that the AC adapter is plugged firmly into a power outlet.

---

### Q2 The scanner is not recognized.

- A2
- 1 Confirm that the scanner is properly connected to the computer with a USB cable.
  - 2 Confirm that the scanner is turned on. See the previous "Q1 The scanner will not turn on."
  - 3 The computer's USB interface may not support the scanner. The scanner cannot be guaranteed to work with all USB interfaces.
  - 4 Confirm that the supplied USB cable is used to connect the scanner to the computer. The scanner cannot be guaranteed to work with all available USB cables.
  - 5 If the scanner is connected to the computer via a USB hub, try removing the hub and connecting directly to the computer.

---

### Q3 Documents feed askew (scanned images are slanted).

- A3
- 1 Align the document guides to fit the documents as closely as possible, and load the documents so that they feed straightly.
  - 2 Enable [Automatically straightens skewed] in the scanner driver settings.
  - 3 If many pages have been scanned since roller cleaning, clean the rollers. If documents still feed askew, roller replacement or other maintenance may be needed. See "Cleaning the Roller Unit and Retard Roller" on p.63 for roller replacement procedures.
-

---

**Q4 Documents are not scanned according to the settings configured in the scanner driver.**

- A4 When you scan using [Select document] panel registered with CaptureOnTouch, the CaptureOnTouch settings have priority over the scanner driver settings. Edit settings in the [Select document] panel, or create a new [Select document] panel using the desired scanning conditions.

---

**Q5 If white lines or streaks appear in scanned images.**

- A5 Clean both sides of the scanner glass, and the rollers. If a sticky substance such as glue or correction fluid is found, carefully wipe with just enough pressure to clean the area where the lines appear. If the problem cannot be solved by cleaning, the internal glass may be scratched. Contact your local authorized Canon dealer.

---

**Q6 Pages are missing.**

- A6 Then the scanner driver's [Scanning Side] setting is [Skip blank page], documents with very little black may be unintentionally skipped. Decrease the [Set the likelihood of skipping blank page] value ("Practical Examples" on p.53), or select another scan mode setting such as [Simplex] or [Duplex]. If pages are skipped due to the document double feeding, see Documents jam (or double-feed)..

---

**Q7 Documents jam (or double-feed).**

- A7
- 1 If the roller has been installed correctly, clean it if necessary.
  - 2 Proper scanning may not be possible when document pages stick together due to static electricity. Fan the documents before you load them.

---

**Q8 Multiple pages of scanned images cannot be saved to a single file.**

- A8 Some file formats cannot save multiple scanned image pages as a single file.
- BMP and JPEG: Scanned images are always saved one page per file.
  - PPTX: Multi-page images are always saved to a single file.
  - TIFF and PDF: Multiple pages can be saved to a single file based on the application software setting.
- For the setting method, see About file formats.

---

**Q9 All of the placed documents have been scanned, but the scanned image does not appear on the application.**

- A9 When [Panel-Feeding] or [Automatic Feeding] is selected as the feeding method on the scanner driver's setting screen, a scanning operation will not continue after all of the documents are fed, as the scanner awaits additional documents to be fed. You can finish the operation and send the scanned images to the application by pressing the stop button on the scanner.

---

**Q10 Memory becomes insufficient and scanning stops.**

- A10 If you configure scanning conditions that use a large amount of the computer's memory, scanning may stop because of insufficient memory. Although this depends on the computer's memory size, the possibility of insufficient memory increases if any of the following scanning conditions overlap.
- [Color Mode] is set to [24-bit Color]
  - A large page size (e.g. Legal) is specified as the [Page Size]. Alternatively, the page size is set to [Scanner's Maximum].
  - A high resolution (600dpi etc.) is specified for [Dots per inch].
- If an error message appears due to insufficient memory while scanning is in progress, exit the application, change the scanning conditions (e.g. reduce the resolution or page size) and then try scanning again. In addition, the amount of memory used can be contained by turning off [Moire Reduction] and [Please change prevent bleed through and remove] if they are set to on.

---

## Q11 Cannot save scanned file.

- A11 The maximum size that can be saved as a file is 2 GB. A multiple-page scan cannot be saved when it reaches the file size of 2 GB. Change the save settings if an error message is displayed.

---

## Q12 If scanning is too slow

- A12
- 1 Close other running programs, if any.
  - 2 Scanning can be slowed down by memory shortage caused by memory-resident applications such as anti-virus programs. Close such memory-resident programs if necessary to free up memory space.
  - 3 When insufficient hard disk space is available, the scanner may be unable to create the necessary temporary files for scanned data. Delete unneeded data on the hard disk to free up more space.
  - 4 Scanning is slow if the computer's USB port is not Hi-Speed USB 2.0 compliant.
  - 5 If using a common USB cable that is not Hi-Speed USB 2.0 compliant, replace the cable with the supplied compliant cable.
  - 6 When the scanner is connected to the computer via a USB hub that is not Hi-Speed USB 2.0 compliant, remove the hub and connect the scanner directly to the computer.

---

## Q13 Scanned image files cannot be opened in an application

- A13
- 1 Scanned images saved as multi-page TIFF files can be opened only by programs that support this file format.
  - 2 Some applications cannot open compressed TIFF files, even if it does not contain multiple pages. This issue can occur with programs that are not compatible with TIFF files of CaptureOnTouch. In this case, select "None" as the image file compression format before scanning.

---

## Q14 Cannot select [2400dpi].

- A14 If you are setting [Long Document Mode], you cannot select [2400dpi].  
Confirm the [Long Document Mode] setting.  
->Setting the Long Document Mode
- 

## Useful tips

---

Here are some useful tips for scanning documents.

### Where are scanned images saved? Can the save destination be changed?

Images are saved to the following locations, according to program settings. All destination locations can be changed to other folders.

- CaptureOnTouch  
Both Standard Scanning and Scanning Shortcut save the output to the destination set in the [Select output] panel.

### How are the scan settings configured?

- CaptureOnTouch  
By clicking the Edit button ([  ]) in the [Select document] panel, you can edit the scan settings when the [Select document edit screen] opens.

### How do I save multiple pages in one file, or save one file per page?

When scanned images are saved in BMP or JPEG format, each image is always saved in a separate file.

When scanned images are saved in PDF or TIFF format, you can specify multi- or single-page files. See also Q8 in "Common Problems and Solutions" on p.70.

### Can I copy or back up scanner setting configurations?

- CaptureOnTouch  
The setting configurations can be backed up and restored using [Backup/Restore] on the [Basic settings] tab on the [Environmental settings] dialog box.

### What rules apply to scanned image file names?

- CaptureOnTouch  
For both Standard Scanning and Scanning Shortcut, the file names of scanned images are set based on the settings in the [Select output] panel. This screen opens when you click the Edit button ([  ]) in the [Select document] panel.

Click the [Detail Settings] button on this screen. You can set the file names of scanned images by setting all or some of the three items shown below.

Setting	Description
File name	Any specified text string to be included in the file name.
Add date and time	Appends the date and time to file names. Select the date format from the list box. YYYY = year, MM = month, and DD = day of month. The time is appended after the date.
Add counter to file names	Append serial numbers in the order of scanned image saving. Specify the number of digits and starting number.

A sample file name is displayed as the [File name] in the [File name settings] dialog box.

### How can I skip blank pages, and scan only non-blank pages?

Specify [Skip Blank Page] on the scanner driver setting screen, then scan.

### How do I load and scan documents with mixed sizes?

Set [Page Size] to [Match original size] on the scanner driver settings screen, then scan. For details, see "To scan unregistered size documents" on p.52.

### What's the best way to scan business cards or photos?

Set [Page Size] to [Match original size] on the scanner driver settings screen, then scan. Alternatively, register the size of the cards or photos to be scanned. For details, see "To scan unregistered size documents" on p.52.

### How do I print scanned data?

- CaptureOnTouch  
For both Standard Scanning and Scanning Shortcut, select [Print] in the [Select output] panel.

- To use this function, you need to install a plug-in.
- The plug-in can be installed by selecting its checkbox when installing CaptureOnTouch.

### How do I save scanned data in a shared folder?

- CaptureOnTouch
  - In CaptureOnTouch, destinations other than [Save to folder] are provided as a plug-in.
  - By installing the plug-in, the scanned image can be printed, attached in an e-mail, or shared using various cloud services.
  - The plug-in can be installed by selecting its checkbox when installing CaptureOnTouch.
  - The available output destinations vary depending on the installed plug-in.

### How can I attach scanned data to an e-mail (or send it as e-mail)?

- CaptureOnTouch  
For both Standard Scanning and Scanning Shortcut, select [Attach to E-mail] in the [Select output] panel.
- To use this function, you need to install a plug-in.
- The plug-in can be installed by selecting its checkbox when installing CaptureOnTouch.

### How do I use the automatic document color detection function?

The scanner driver for this scanner includes a function that automatically detects the color mode from the contents of a document.

The color modes that can be detected automatically by this function depend on the application and scanner driver settings you are using as follows.

Condition	Modes that can be detected
When [Color mode] is set to [Detect automatically] in the CaptureOnTouch scanner settings	[Color or Gray]
When [Full Automatic Mode] is selected in the scanner driver	
When [Color mode] is set to [Detect automatically] in the scanner driver, and advanced settings for auto-detection are set	One of the following can be selected: <ul style="list-style-type: none"> <li>• [Color or Gray]</li> <li>• [Color or Binary]</li> <li>• [Color, Gray or Binary]</li> </ul>

## Chapter 12 Appendix

Specifications .....	75
Replacement Parts .....	76
External Dimensions.....	77

## Specifications

---

### Main Unit

Type	ADF/flatbed scanner
Scanning Document Size	
Feeder	Width: 51 mm to 216 mm (2" to 8.5") Length: 89 mm to 356 mm (3.5" to 14.0") Thickness: 35 to 128g/m <sup>2</sup> (9 to 32 lb bond) Capacity (80g/m <sup>2</sup> paper): 50 sheets or stacked to a height of 6.0 mm (0.2") (including curling)
Flatbed	Width: 216 mm (8.5") Length: 356 mm (14.0")
Feeding Method	Automatic
Scanner Element	Contact image sensor
Light Source	LED
Scanning Sides	Simplex, Duplex, Skip blank pages
Scanning Modes	Black and White, Advanced Text Enhancement, Advanced Text Enhancement II, Error Diffusion, 256-level Gray, 24-bit Color
Scanning Resolution (primary scan lines × secondary scan lines)	100 × 100 dpi, 150 × 150 dpi, 200 × 200 dpi, 240 × 240 dpi, 300 × 300 dpi, 400 × 400 dpi, 600 × 600 dpi 1200 × 1200 dpi, 2400 × 2400 dpi,
Scanning Speed (A4, 200 dpi, Simplex)	
Feeder	Black and White: 20 ppm Gray: 20 ppm Color: 10 ppm
Interface	Hi-Speed USB 2.0
Dimensions	469 mm (W) × 335 mm (D, excluding ADF cable) × 120 mm (H) (18.5" × 13.2" × 4.8")
Weight	Approx. 4.6 kg (10.1 lb)
Power Consumption	Scanning: Maximum 19.9W (120V, 220-240V), 20.8W (100V) In the Sleep Mode: 2.5W With power switch OFF: Maximum 0.5 W
Noise	46dB or less
Operating Environment	Temperature: 10°C to 32.5°C (50°F to 90.5°F ) Humidity: 20% to 80% RH

\*You can scan documents up to 1,000 mm (39.3") long by setting the scanner to the Long Document mode. -> "Setting the Long Document Mode" on p.26

## AC Adapter (100 to 240 V type)

Model Number	MG1-4558
Input	AC100 to 240V, 50/60 Hz, 1.1 to 0.58 A
Output	DC24V 2.0A
Weight	Approximately 0.4kg (0.88 lb) (including power cord)



### IMPORTANT

The information in this document is subject to change without notice.

## Replacement Parts

---

### Exchange roller kit (product code: 9934B001)

Kit to replace the rollers (feed roller unit, retard roller).

- Contact your local authorized Canon dealer or service representative for detailed information about the replacement parts.

Product specifications are subject to change without notice.



## External Dimensions

---

### Front View

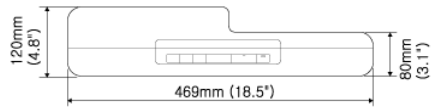

### With the document feed tray open

