

# Temperature differential controller

5 inputs, 2 outputs



## Installation and operating instructions

EN

# Content

	General safety instructions.....	3
	EC declaration of conformity.....	3
<b>1</b>	<b>Proper usage .....</b>	<b>4</b>
<b>2</b>	<b>About this manual .....</b>	<b>4</b>
2.1	Contents.....	4
2.2	Target audience .....	4
<b>3</b>	<b>Installation .....</b>	<b>5</b>
3.1	Opening / Closing the casing .....	5
3.2	Mounting the casing .....	6
3.3	Establishing the electrical connections.....	7
3.4	Terminal pin assignments.....	10
<b>4</b>	<b>Commissioning the device for the first time.....</b>	<b>13</b>
<b>5</b>	<b>Construction .....</b>	<b>17</b>
5.1	Casing.....	17
5.2	Display.....	17
<b>6</b>	<b>Operation .....</b>	<b>20</b>
6.1	Operating buttons .....	20
6.2	Display when operating.....	20
<b>7</b>	<b>Modes of operation .....</b>	<b>20</b>
7.1	Changing the mode of operation .....	20
7.2	Off mode .....	21
7.3	Manual mode .....	21
7.4	Automatic mode.....	22
<b>8</b>	<b>Settings menu.....</b>	<b>23</b>
8.1	Overview.....	23
8.2	Calling up the settings menu and selecting a menu entry .....	26
8.3	Setting the time.....	26
8.4	Setting the system .....	26
8.5	Setting the functions .....	26
8.6	Setting the parameters .....	26
8.7	Setting the priority .....	27
8.8	Resetting to factory defaults.....	27
<b>9</b>	<b>Functions.....</b>	<b>28</b>
9.1	Operation .....	28
9.2	Characteristics .....	29
9.3	Function descriptions.....	31
<b>10</b>	<b>Parameters .....</b>	<b>43</b>
<b>11</b>	<b>Deinstallation and disposal .....</b>	<b>46</b>
<b>12</b>	<b>Information messages .....</b>	<b>46</b>
<b>13</b>	<b>Troubleshooting.....</b>	<b>46</b>
13.1	General faults .....	47
13.2	Error messages .....	48
13.3	Checking the Pt1000 temperature sensors .....	49

---

14	Technical data .....	50
14.1	Controller .....	50
14.2	Cable specifications .....	51
	Exclusion of liability.....	51
	Legal guarantee .....	51

## General safety instructions

- This document is part of the product.
- Use the device only after reading and understanding this document.
- Keep this document in a safe place for the entire service life of the device. Pass this document on to subsequent owners and operators of the device.
- Adhere to all safety instructions. Consult (further) professional personnel in the event of any ambiguities.
- The measures described in this document may only be performed by qualified technical professionals. Exception: End-customers may operate the device when they have previously been trained by a technical professional.
- The solar system can be damaged by improper operation of the device.
- The device must not be connected to the power supply if it has an open or damaged casing.
- The device must not be connected to the mains power supply when:
  - the casing is open or damaged.
  - cables are damaged.
- Factory labels and markings must never be altered, removed or rendered unreadable.
- Observe the prescribed conditions of use, see Section 14, p. 50.
- This device is not intended for:
  - Children
  - Persons with physical, sensory or mental impairment
  - Persons without sufficient experience or knowledge unless they are instructed in the use of the device, and initially supervised, by a person responsible for their safety.

## EC declaration of conformity

This product conforms to the applicable European directives with regard to its design and its operating behaviour. This conformity has been verified. Further information in this regard can be obtained from your dealer.

## 1 Proper usage

The temperature differential controller, subsequently referred to as the *controller*, is an independently installed electronic temperature controller for on-surface installation. Integration into a pump assembly is possible when the technical specifications of the controller are adhered to.

The maintenance-free controller is exclusively intended for controlling solar and heating systems.

## 2 About this manual

### 2.1 Contents

This manual contains all information required by a technical professional for setting up and operating the temperature differential controller.

### 2.2 Target audience

The target audience of this manual are technical professionals who:

- have the knowledge of terminology and the skills necessary for setting up and operating solar systems.
- have the necessary training, knowledge and experience, and knowledge of the applicable regulations in order to evaluate and recognise the dangers inherent in the following work:
  - Installation of electrical equipment
  - Production and connection of data communication cables
  - Production and connection of mains grid power supply cables

## 3 Installation

### Note

The following section describes only the installation of the *controller*. Follow the instructions of each respective manufacturer when installing external components (collectors, pumps, storage tanks, valves etc.)

### 3.1 Opening / Closing the casing

#### 3.1.1 Removing the front panel

- ▶ Grasp the front panel ① by the grooves at the sides ② and pull forwards ③ (Fig. 1).

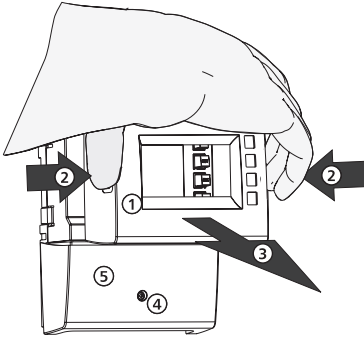

Fig. 1: Removing the front panel

#### 3.1.2 Mounting the front panel

- ▶ Carefully position the front panel ① and then press it onto the casing until it latches into place.

#### 3.1.3 Removing the terminal cover



### Danger

Risk of death by electrocution!

- Disconnect the controller from the power supply before removing the terminal cover.
- Make sure that the power supply cannot be unintentionally switched on when the device is open.

1. Remove the screw ④ (Fig. 1).
2. Remove the terminal cover ⑤.

#### 3.1.4 Mounting the terminal cover

1. Position ⑤ the cover.
2. Tighten the screw ④ to a torque of 0.5 Nm.

## 3.2 Mounting the casing

- ✓ The mounting location must satisfy the prescribed conditions of use; more information on this is provided in Section 14, p. 50.
- ✓ The mounting surface is vertical and allows good access for installation.



### Danger

Risk of death by electrocution!

- Disconnect the controller from the power supply before opening the casing.
- Make sure that the power supply cannot be unintentionally switched on when the casing is open.
- Do not use the casing as a drilling template.

1. If necessary, remove the terminal cover
2. Screw in the screw for the upper mounting hole ❶ (Fig. 2) until the screw head has a clearance of 5 ... 7 mm from the mounting surface.
3. Hang the controller on the screw by the upper mounting hole and align it vertically.
4. Mark the position of the lower mounting hole ❷ through the casing.
5. Remove the controller and prepare the mounting hole for the lower screw.
6. Hang the controller by the upper mounting hole ❶ and then fasten the screw in the lower mounting hole ❷.
7. Mount the terminal cover.

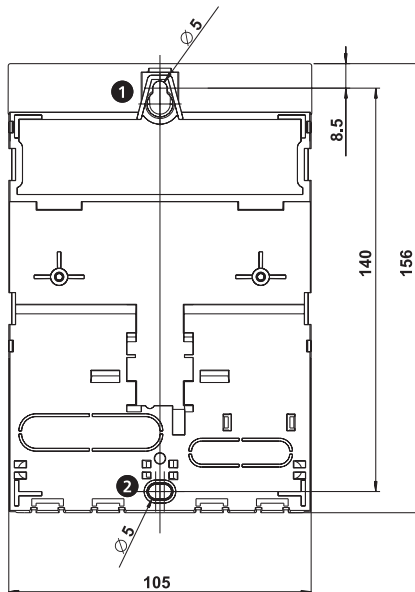

Fig. 2: Rear side of the controller with the upper ❶ and lower mounting holes ❷

### 3.3 Establishing the electrical connections

---



#### Danger

Risk of death by electrocution! Make sure that the following conditions are satisfied when performing the work described in this section:

- All cables leading to the controller must be disconnected from the power supply and it must be ensured that they cannot be unintentionally reconnected during installation.
  - Each connection terminal must only be connected to a single conductor.
  - The protective earth conductors (PE) from the mains cable and pump and valve cables must be connected to the *protective earth conductor terminal block*.
  - All cables must be laid so that persons cannot stand on them or trip over them.
  - The cables must satisfy the requirements listed in Section 14.2, p. 51.
  - The local power supply must match the specifications on the type plate of the controller.
  - The power supply cable is to be connected to the mains power as follows:
    - using a plug connected to a wall mains socket *or*
    - via an isolating mechanism allowing complete isolation in the case of permanent wiring.
  - The power supply cable must be laid in conformance to all applicable legal guidelines and regulations of the local electricity supplier.
- 

#### Notice

Danger of damage and malfunction.

- Connect only components that do not overload the controller inputs and outputs; more information is provided on the type plate and in Section 14, p. 50.
  - For outputs R1 and R2 the following applies:
    - Speed control must be deactivated when an external relay is connected.
    - The correct pump type must be set (standard/high-efficiency pump).More information on this is provided in Sections 4, p. 13 and 10, p. 43 (P18, P19).
- 

#### Notes

- Any connection polarity may be used for the 1 – 5 and R<sub>S</sub> signal inputs and outputs.
  - Only type Pt1000 temperature sensors may be used.
  - Lay the sensor cables at least 100 mm away from any power supply cables.
  - Use shielded sensor cables when inductive sources are present, e.g. high-voltage lines, radio transmitters, microwave devices.
-

### 3.3.1 Position of the connection terminals

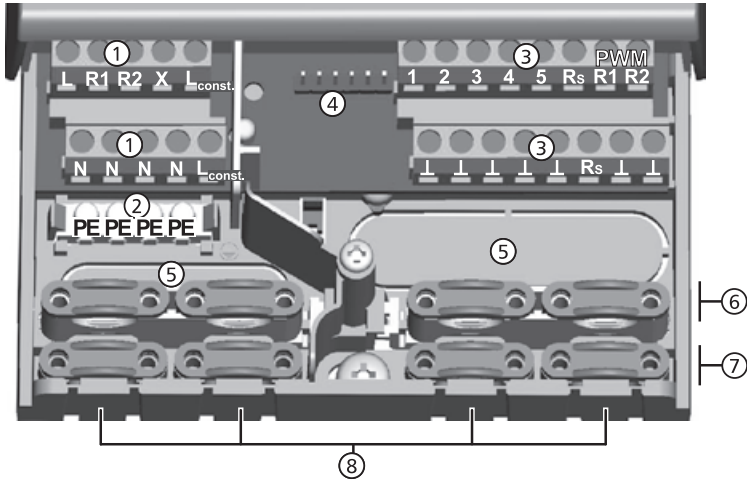

Fig. 3: Terminal clamps in the lower part of the controller (terminal cover removed)

①	<p><b>Power connection terminal block</b></p> <p>L            1x phase conductor (mains input)</p> <p>R1, R2     2x output (TRIAC, for pumps or valves)</p> <p>X            not used</p> <p>L<sub>const.</sub>    2x phase conductor (outputs, permanent voltage)</p> <p>N            4x neutral conductor (common neutral conductors for mains power input and outputs)</p> <hr/> <p><b>Note</b></p> <p>Outputs R1 and R2 are protected by an electronic fuse.</p>
②	<p><b>Protective conductor terminal block:</b></p> <p>PE         4x protective earth (common protective earth for <i>power connection</i>) terminal block</p>
③	<p><b>Signals terminal block:</b></p> <p>1 – 4      4x sensor input (Pt1000 temperature sensor)</p> <p>5          1x sensor input (Pt1000 temperature sensor or pulse water meter input)</p> <p>R<sub>S</sub>        1x signal output (potential-free relay contact for safety extra-low voltage)</p> <p>PWM R1   2x control output (for PWM-controlled high-efficiency pumps)</p> <p>PWM R2</p> <p>⊥         7x mass connection (common mass for sensor inputs and control outputs)</p>
④	Pin strip, for internal use only
⑤	Cable openings on the rear side of the casing
⑥	Upper strain relief clamps (2 identical plastic links, each with 2 strain relief clamps, supplied in the scope of delivery)
⑦	Lower strain relief clamps
⑧	Cable openings at the bottom of the casing



### 3.3.2 Preparing the cable openings

The cables can be fed through openings in the rear wall of the casing or at the bottom of the casing. The openings are pre-punched and must be prepared as required before installation.

**Prepare the cable openings in the rear wall of the casing as follows:**

1. Break out the cable openings ⑤ (Fig. 3) using a suitable tool.
2. Deburr the edges.

**Prepare the cable openings at the bottom of the casing as follows:**

1. Cut the *required* cable openings ⑧ (Fig. 3) at the left and right using a suitable knife and break them out.
2. Deburr the edges.

### 3.3.3 Connecting the cables

- ✓ All cables are voltage-free.
- ✓ The cable openings have been prepared.

► Observe the following points when connecting the cables:

- Connect the cable conductors to the correct terminals as described in Section 3.4, p. 10.
- Mains input and outputs: First connect PE, then N and L.
- Strain relief:
  - First clamp the *lower* strain relief clamps and then the *upper* strain relief clamps.
  - When using the upper strain relief clamps, use the plastic links as described below.
  - If the opening in the strain relief clamp is too large, e.g. in the case of thin cables, turn over the strain relief clamping bar (with the bend facing down).
  - Only use the strain relief clamps for cables entering the bottom of the casing. Use external strain relief clamps when feeding cables through the rear of the casing.

### 3.3.4 Inserting/Removing plastic links

**Insert the plastic links as follows:**

1. Insert the right plastic strip with the latching protrusion first ① (Fig. 4).
2. Press the other side of the plastic strip down ②, until the spring clamp latches into place.
3. Insert the left plastic strip the other way around (latching protrusion to the left, spring clamp to the right).

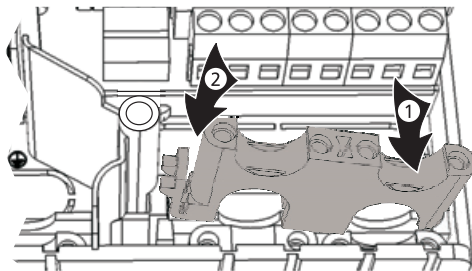

Fig. 4: Inserting the right plastic link

**Remove the plastic links as follows:**

1. Insert a flat-blade screwdriver under the right plastic link between the casing and the spring clamp ①, ② (Fig. 5).
2. Carefully push the flat-blade screwdriver to the left ③. Lever the spring clamp ① to the right until the plastic link ④ is free.
3. Pull out the plastic link upwards by hand ⑤.
4. Remove the left plastic link accordingly.

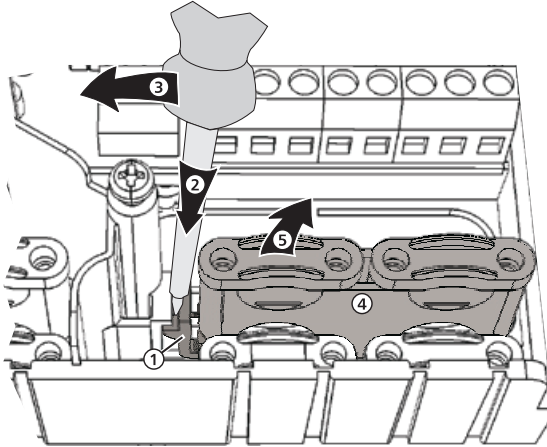

Fig. 5: Removing the right plastic link

### 3.4 Terminal pin assignments

For each solar system that can be selected at the controller, the external components (pumps, valves, temperature sensors) must be connected to particular terminals. The following table provides information on this:

- Graphic and number of the solar system on the controller display. The graphic is only intended to provide an overview and is not a technical drawing.
- Terminal pin assignments of the connected components

Display	Legend	Terminal layout
<b>No system</b>		
	<p><b>Note</b>  <i>No system</i> is used when only the functions are used. When <i>No system</i> is selected then all inputs and outputs are freely available for use by the functions. More information on this is provided in Section 9, p. 28.</p>	
<b>1 storage tank, 1 collector array</b>		
	<p>T1: Collector array sensor                  T2: Lower storage tank sensor                  R1: Solar circuit pump</p>	<p>1, <math>\perp</math>                  2, <math>\perp</math>                  R1, N, PE (PWM R1, <math>\perp</math> <sup>1)</sup>)</p>

Display	Legend	Terminal layout
<b>1 storage tank with heating return increase, 1 collector array</b>		
	<b>1.2</b> <i>T1</i> : Collector array sensor <i>T2</i> : Lower storage tank sensor <i>T3</i> : Upper storage tank sensor <i>T4</i> : Sensor heating return increase <i>R1</i> : Solar circuit pump <i>R2</i> : Heating return switching valve <sup>3)</sup>	1, $\perp$ 2, $\perp$ 3, $\perp$ 4, $\perp$ R1, N, PE (PWM R1, $\perp$ <sup>1)</sup> ) R2, N, PE
<b>1 storage tank with external heat exchanger, 1 collector array</b>		
	<b>1.3</b> <i>T1</i> : Collector array sensor <i>T2</i> : Lower storage tank sensor <i>T3</i> : External heat exchanger sensor <i>R1</i> : Storage tank loading circuit pump <i>R2</i> : Solar circuit pump	1, $\perp$ 2, $\perp$ 3, $\perp$ R1, N, PE (PWM R1, $\perp$ <sup>1)</sup> ) R2, N, PE (PWM R2, $\perp$ <sup>2)</sup> )
<b>1 storage tank with zone loading, 1 collector array</b>		
	<b>1.4</b> <i>T1</i> : Collector array sensor <i>T2</i> : Lower storage tank sensor <i>T3</i> : Upper storage tank sensor <i>R1</i> : Solar circuit pump <i>R2</i> : Zone loading switching valve <sup>4)</sup>	1, $\perp$ 2, $\perp$ 3, $\perp$ R1, N, PE (PWM R1, $\perp$ <sup>1)</sup> ) R2, N, PE
<b>1 storage tank, 2 collector arrays</b>		
	<b>1.5</b> <i>T1</i> : Collector array 1 sensor <i>T2</i> : Collector array 2 sensor <i>T3</i> : Lower storage tank sensor <i>R1</i> : Solar circuit pump for collector array 1 <i>R2</i> : Solar circuit pump for collector array 2	1, $\perp$ 2, $\perp$ 3, $\perp$ R1, N, PE (PWM R1, $\perp$ <sup>1)</sup> ) R2, N, PE (PWM R2, $\perp$ <sup>2)</sup> )
<b>2 storage tanks, 1 collector array (pump-controlled)</b>		
	<b>2.1</b> <i>T1</i> : Collector array sensor <i>T2</i> : Sensor lower area of storage tank 1 <i>T3</i> : Sensor lower area of storage tank 2 <i>R1</i> : Solar circuit pump, storage tank 1 <i>R2</i> : Solar circuit pump, storage tank 2	1, $\perp$ 2, $\perp$ 3, $\perp$ R1, N, PE (PWM R1, $\perp$ <sup>1)</sup> ) R2, N, PE (PWM R2, $\perp$ <sup>2)</sup> )
<b>2 storage tanks, 1 collector array (pump/valve controlled)</b>		
	<b>2.2</b> <i>T1</i> : Collector array sensor <i>T2</i> : Sensor lower area of storage tank 1 <i>T3</i> : Sensor lower area of storage tank 2 <i>R1</i> : Solar circuit pump <i>R2</i> : Storage tank switching valve <sup>5)</sup>	1, $\perp$ 2, $\perp$ 3, $\perp$ R1, N, PE (PWM R1, $\perp$ <sup>1)</sup> ) R2, N, PE

Display	Legend	Terminal layout
<b>1 swimming pool, 1 collector array</b>		
	<p><i>T1</i>: Collector array sensor  <i>T2</i>: Swimming pool sensor  <i>R2</i>: Solar circuit pump</p>	<p>1, <math>\perp</math>  2, <math>\perp</math>  R2, N, PE (PWM R2, <math>\perp</math> <sup>2)</sup>)</p>
<b>1 swimming pool with external heat exchanger, 1 collector array</b>		
	<p><i>T1</i>: Collector array sensor  <i>T2</i>: Swimming pool sensor  <i>T3</i>: External heat exchanger sensor  <i>R1</i>: Solar circuit pump  <i>R2</i>: Swimming pool loading circuit pump</p>	<p>1, <math>\perp</math>  2, <math>\perp</math>  3, <math>\perp</math>  R1, N, PE (PWM R1, <math>\perp</math> <sup>1)</sup>)  R2, N, PE (PWM R2, <math>\perp</math> <sup>2)</sup>)</p>
<b>1 storage tank, 1 swimming pool, 1 collector array (pump-controlled)</b>		
	<p><i>T1</i>: Collector array sensor  <i>T2</i>: Lower storage tank sensor  <i>T3</i>: Swimming pool sensor  <i>R1</i>: Storage tank solar circuit pump  <i>R2</i>: Swimming pool solar circuit pump</p>	<p>1, <math>\perp</math>  2, <math>\perp</math>  3, <math>\perp</math>  R1, N, PE (PWM R1, <math>\perp</math> <sup>1)</sup>)  R2, N, PE (PWM R2, <math>\perp</math> <sup>2)</sup>)</p>
<b>1 storage tank, 1 swimming pool, 1 collector array (pump/valve controlled)</b>		
	<p><i>T1</i>: Collector array sensor  <i>T2</i>: Lower storage tank sensor  <i>T3</i>: Swimming pool sensor  <i>R1</i>: Solar circuit pump  <i>R2</i>: Storage tank switching valve <sup>6)</sup></p>	<p>1, <math>\perp</math>  2, <math>\perp</math>  3, <math>\perp</math>  R1, N, PE (PWM R1, <math>\perp</math> <sup>1)</sup>)  R2, N, PE</p>

Tab. 1: Terminal pin assignments

- 1) Terminal pin assignments for PWM-controlled high-efficiency pumps: The power supply must be connected to output R1 (N, PE), the control cable for the pump electronics must be connected to PWM R1 and  $\perp$ .
- 2) Terminal pin assignments for PWM-controlled high-efficiency pumps: The power supply must be connected to output R2 (N, PE), the control cable for the pump electronics must be connected to PWM R2 and  $\perp$ .
- 3) Installation regulation: When **no power** is supplied to the switching valve then **no flow** occurs through the storage tank.
- 4) Installation regulation: When **no power** is supplied to the switching valve then the **lower part** of the storage tank (*T2*) is loaded.
- 5) Installation regulation: When **no power** is supplied to the switching valve then the **first priority** storage tank (*T2*) is loaded.
- 6) Installation regulation: When **no power** is supplied to the switching valve then the **storage tank** (*T2*) is loaded.

## 4 Commissioning the device for the first time



### Danger

Risk of death by electrocution! Be sure to perform all the measures listed in Section 3 before starting the first commissioning.

### Notes

- After commissioning the controller for the first time, it is configured in such a manner that it can be used in most applications without changes.
- After completing the first commissioning, later recommissioning is not necessary.
- The following steps must also be performed after the device has been reset to the factory defaults.

### Overview

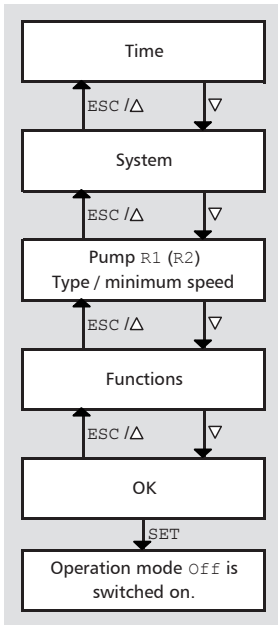

The first time the controller is switched on, the following main settings are made blockwise via a guided configuration process (Fig. left):

- Time
- System (hydraulic variant)
- Type (Standard/high-efficiency pump) and minimum speed of the connected pumps (not *System 0.1*)
- Functions

Values can be subsequently changed during the guided configuration process. The following applies:

- ∇/ESC/Δ *blockwise* navigation forwards and back (Fig. left: ∇ = forwards; ESC/Δ = back).
- Navigation (with ∇/ESC/Δ) is always possible after completing a block.
- Subsequent modification of a block is started with SET.

### Commission the controller for the first time as follows:

#### Setting the time



1. Apply power to the controller.
  - The time 12:00 is displayed.
  - 12 flashes (Fig. left)
  - The backlighting is red.
2. Press ∇Δ to set the hours.
3. Press SET. The minutes flash.
4. Press ∇Δ to set the minutes.
5. Press SET.

### Selecting a system

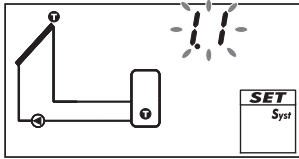

6. Press  $\nabla$ . *System 1.1* is displayed, 1.1 flashes (Fig. left).
7. Press  $\nabla\Delta$  to select another system.
8. Press SET.  
If *System 0.1* was selected in step 7, proceed with step 20.

### Setting pump 1 (output R1)

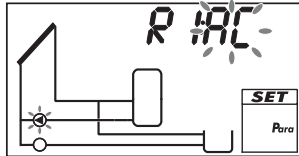

9. Press  $\nabla$ . AC and  $\odot$  (pump 1) flash (example in fig. left).

10.

---

#### Notice

Standard pump: Select AC!

High-efficiency pump: Select HE!

Press  $\nabla\Delta$  to select the type for pump 1.

11. Press SET.

12.

---

#### Notice

When selecting HE (high-efficiency pump) pay attention to the pump characteristics.

Only if HE was selected in step 10:

Press  $\nabla\Delta$  to set the characteristic of the high-efficiency pump; see Tab. 2 and Fig. 6, p. 16.

13. Press SET.

- If AA or Ab was selected in step 12 then SC is displayed; off,  $\odot$  and  $\ominus$  (pump 1) flash (example in Fig. left; SC = Speed Control).
- If C was selected in step 12, proceed with step 18 (for 2 pumps) or step 20 (for 1 pump).

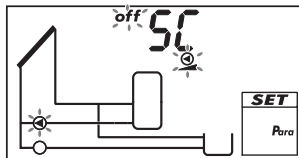

14. If required, press  $\nabla\Delta$  to switch on the speed control (on flashes).

15. Press SET.

If off was selected in step 14, proceed with step 18 (for 2 pumps) or step 20 (for 1 pump).

16. min, Value %,  $\odot$  and  $\ominus$  (pump 1) flash.

Press  $\nabla\Delta$  to set the minimum speed of pump 1 in %.

17. Press SET.

Make the settings for pump 2 (output R2; only if a system with 2 pumps was selected in step 7, otherwise continue with step 20).

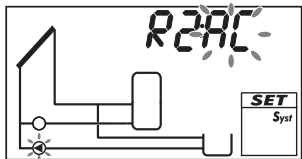

18. Press  $\nabla$ . AC and  $\odot$  (pump 2) flash (example in fig. left).
19. Perform steps 10 to 17 accordingly for pump 2.

20. Press  $\nabla$ . F: is displayed.

Set the functions (Necessary for System 0.1, or as required for other systems. The functions can also be set at a later date.)

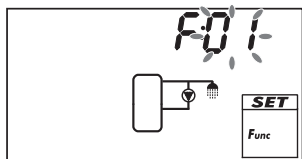

21. Press SET to set the functions. F:01 (function number) flashes (example in Fig. left).  
or  
Press  $\nabla$  to skip the setting of the functions; Ok flashes. Continue with step 30.

22. Press  $\nabla\Delta$  to select a different function. (Function description in Section 9.3, p. 31)
23. Press SET. OFF is displayed.
24. Press SET. OFF flashes.
25. Press  $\nabla\Delta$ . on flashes.
26. Press SET. The function is activated.
27. Set the characteristics (see Section 9.1, p. 28).
28. Press ESC.
29. Press  $\nabla$ . Ok flashes.

Finishing initial commissioning

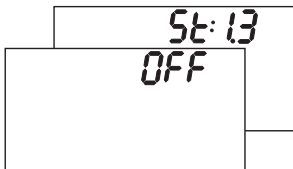

30. Press SET to finish the initial commissioning. The controller switches to the operating mode OFF (example in Fig. left).  
or  
Press  $\Delta$ /ESC to display the previous settings and correct them if necessary.

Set the operating mode (off, manual, automatic)

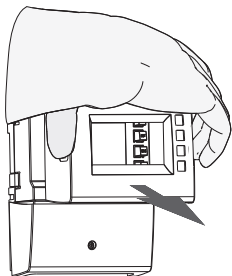

31. Remove the front panel (Fig. left and section 3.1.1, p. 5).

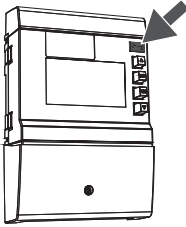

32.

**Notice**

Danger of pump damage if run dry. Only switch the system to **manual** or **automatic** mode when the system is filled.

Press and hold the mode button  (arrow in Fig. left) for 2 seconds to change the mode of operation; more information on this is provided in Section 7, p. 20.

33. Mount the front panel. The controller is now ready for operation.

**Characteristics of high-efficiency pumps**

Display	Pump type	Characteristic curve
AA	High-efficiency pump with a PWM profile for a rising characteristic curve (Fig. 6)	0% PWM: Pump off 100% PWM: Max. pump speed
Ab	High-efficiency pump with a PWM profile for a falling characteristic curve (Fig. 6)	0% PWM: Max. pump speed 100% PWM: Pump off
C	Pressure regulated high-efficiency pump	– (no control cable, switching on/off via the supply voltage)

Tab. 2: Characteristics of high-efficiency pumps

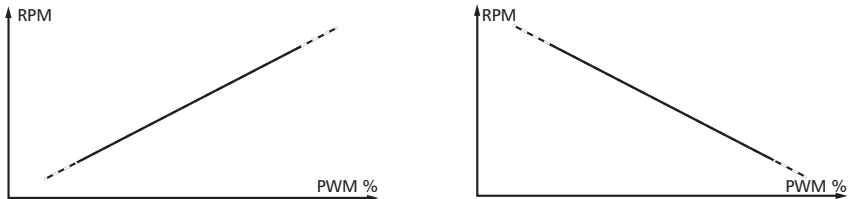
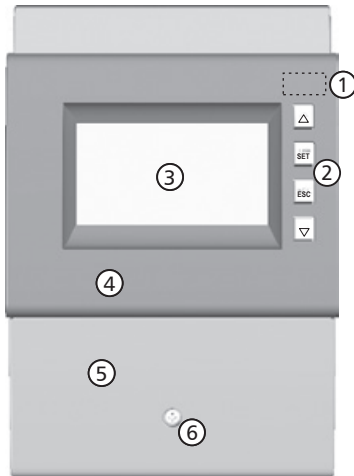

Fig. 6: Characteristics of high-efficiency pumps with PWM profiles for a rising characteristic curve (AA, left) and a falling characteristic curve (Ab, right)



## 5 Construction

### 5.1 Casing

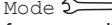

No.	Element	See section
①	Mode  button (under front panel)	6.1 7
②	Operating buttons: $\Delta$ , SET, ESC, $\nabla$	6.1
③	Display	5.2
④	Front panel	3.1
⑤	Terminal cover	3.3.1 <sup>1)</sup>
⑥	Terminal cover fastening screw	–

<sup>1)</sup> Section 3.3.1 describes the terminals under the terminal cover.

Fig. 7: Front view of the controller

## 5.2 Display

### 5.2.1 Overview

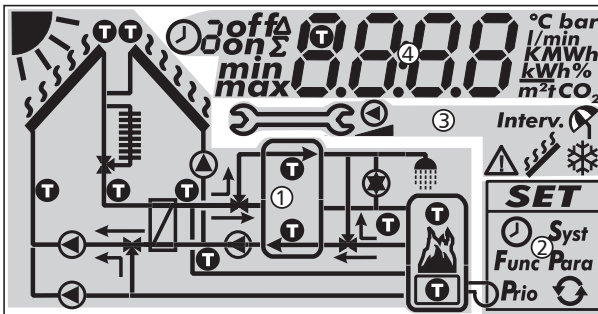









Fig. 8: Overview of the display areas (all elements visible)







①	System graphics
②	Settings menu
③	Pictograms for functions
④	Operational and setting values

The display areas are described below.

## 5.2.2 System graphical symbols



The following table describes the symbols used in the system graphics (① in Fig. 8).

Symbol	Description
	Pipework
	Collector (array)
	Maximum collector temperature reached
	Storage tank
	Swimming pool
	External heat exchanger
	Temperature sensor
	Sufficient solar irradiation available for loading

Symbol	Description
	Pump, switched on
	Pump, switched off
	3-way valve with flow direction
	Domestic water outlet
	Cooler for active cooling
	Back-up heating
	Solid fuel boiler



## 5.2.3 Settings menu



The settings menu (② in Fig. 8) contains the following entries:

SET	
Time	 <b>Syst</b> System
Functions	 <b>Func Para</b> Parameters
Priority	 <b>Prio</b> Reset to factory defaults

## 5.2.4 Pictograms for functions

The following table describes the pictograms used for functions (③ in Fig. 8).

Symbol	Description
	Manual operation
	Pump is speed controlled <sup>1)</sup>
<b>Interv.</b>	Interval <sup>2)</sup>
	Frost protection <sup>2)</sup>

Symbol	Description
	Holiday - recooling <sup>2)</sup>
	Alarm output <sup>1)</sup>
	Stagnation reduction <sup>2)</sup>

<sup>1)</sup> Symbol is visible while the function/parameter is being edited in the settings menu.

<sup>2)</sup> Symbol flashes: The function is activated and is actively intervening in the control process.  
Symbol *does not* flash: The function is activated and is *not* actively intervening in the control process or the function is currently being edited in the setting menu.

## 5.2.5 Operational and setting values

The display of the operational and setting values (④ in Fig. 8) consists of the following elements:

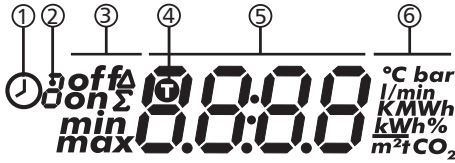

①	<p>Symbol for time control of functions. This symbol is displayed when:</p> <ul style="list-style-type: none"> <li>• a time restriction / control has been set,</li> <li>• the status of time restriction/control is displayed,</li> <li>• the time restriction blocks a temperature control (symbol flashes).</li> </ul>
②	<p>Number of the time window that is currently being set/displayed or within which the current time lies. The time control of a function consists of 1 to 3 configurable time windows. Example: Time window 1 06:00 – 08:00 Time window 2 11:00 – 12:30 Time window 3 17:00 – 19:00</p>
③	<p>Additional information on, off: Switching state/condition <i>on</i>, <i>off</i> max, min: <i>Maximum</i> value, <i>minimum</i> value Σ: Summed operational value since first commissioning, cannot be reset Δ: Summed operational value since last reset to 0</p>
④	<p>Symbol is displayed when a temperature sensor is selected when setting a function.</p>
⑤	<p>Display of:</p> <ul style="list-style-type: none"> <li>• Measurements</li> <li>• Settings</li> <li>• Error codes</li> <li>• Additional information, e.g. software version</li> </ul>
⑥	<p>Physical unit of the value displayed in ⑤: °C, K, l/min, %, h, kWh, MWh, tCO<sub>2</sub></p>

## 6 Operation

This section contains general information on operating the controller.

### 6.1 Operating buttons

The device is operated using the  $\triangle$ ,  $\nabla$ , SET, ESC and  $\text{↺↻}$  buttons as follows:

$\triangle$	<ul style="list-style-type: none"> <li>Scrolls up through the menu/initial commissioning</li> <li>Increases the setting value by 1 step</li> </ul>
$\nabla$	<ul style="list-style-type: none"> <li>Scrolls down through the menu/initial commissioning</li> <li>Decreases the setting value by 1 step</li> </ul>
SET	<ul style="list-style-type: none"> <li>Selects a setting to be changed (setting value flashes)</li> <li>Confirms a setting value or jumps one level down in the menu structure</li> <li>Calls up the settings menu (not in manual mode)</li> </ul>
ESC	<ul style="list-style-type: none"> <li>Discards an entered setting</li> <li>Jumps up by one operating level</li> <li>Scrolls up through the initial commissioning</li> </ul>
$\text{↺↻}$	Sets the operating mode

#### Note

We recommend that you write down all settings that you have changed.

### 6.2 Display when operating

- A flashing component in the system graphic means: The displayed operational or setting value applies to the flashing component.  
Exception:  $\text{↺↻}$  always flashes in manual mode.
- A flashing symbol is indicated in the figures by  $\text{⚡}$ .
- Displays that are automatically alternately displayed are shown overlapping in the figures. Example: Figure in Section 7.2, p. 21.

## 7 Modes of operation

### 7.1 Changing the mode of operation

#### Notice

Danger of pump damage if run dry. Only switch the system to manual or automatic mode when the system is filled.

- Remove the front panel.
- Press the  $\text{↺↻}$  button for 2 seconds to change the mode of operation.
- Repeat step 2 if necessary.
- Mount the front panel.

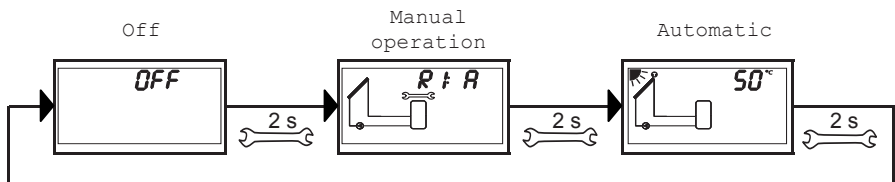

## 7.2 Off mode

### Functionality

- All outputs are switched off (outputs/control outputs without power, relays open).
- OFF and the software version are displayed alternately.  
See example in Fig. below: Software version St 1.3
- Backlighting is red.
- Settings menu can be called up.
- The Off mode is preset when the device is delivered.

### Operation

- ▶ Press and hold the SET button for 2 seconds to call up the settings menu (1).

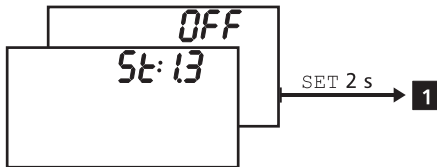

## 7.3 Manual mode

### Functionality

- Backlighting is red, spanner symbol  flashes.
- The controller outputs (pumps, valves) can be manually switched. Possible switching states
  - 0: off
  - 1: on
  - A: Automatic operation as per the settings in the settings menu
- Current temperatures and operating hours can be displayed (status display).
- When changing to manual mode all outputs are switched to A, R1 is displayed.  
Exception: First commissioning (all outputs at 0).
- Typical application: Functional test (maintenance), fault-finding.

### Operation

You switch the outputs on and off as follows:

1. If necessary, press  $\triangle \nabla$  to select a different output.
2. Press SET. The switching state flashes.
3.  $\triangle \nabla$  - Press to change the switching state.
4. Press SET to adopt the change.

See 2 in the following Figure (system 1.1 and output R1 are shown as an example).

You display the current temperatures and operating hours as follows:

1. Press ESC. The temperature/operating hours are displayed and the associated component flashes (3, display is not illustrated).
2.  $\triangle \nabla$  - Press to select a different component.
3. Press SET to leave the temperature/operating hours display.

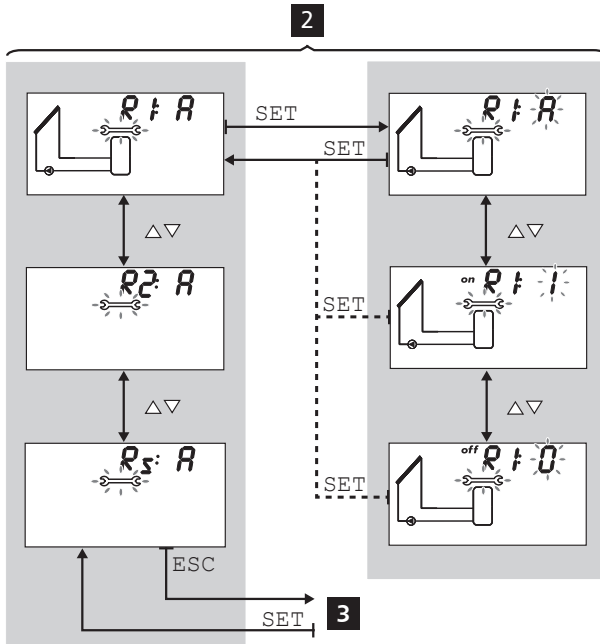

## 7.4 Automatic mode

### Functionality

*Automatic* is the normal mode of operation and the system is automatically controlled. The following actions are possible:

- Display status (status display): Display the status of external components (temperatures, switching states, run times).
- Display stored min./max. values (temperature sensors) or sum/difference values (operating hours<sup>1)</sup> of the pumps and valves).

*Summed values* (symbol  $\Sigma$ ): Operating hours since first commissioning. Summed values cannot be reset.

*Difference values* (symbol  $\Delta$ ): Operating hours since the last reset to 0.

- Reset the stored min./max./difference values.
- Call up the settings menu.

<sup>1)</sup> Summed switch-on times of the outputs

## Operation

✓ The controller shows the status display.

You can display the status of external components as follows:

- ▶  $\triangle \nabla$  - Press to display the status of other components (4, shown using system 1.1 as an example).

You can display and reset the stored min./max./difference values as follows:

1. Press  $\triangle \nabla$  as required, in order to display other components (4, component flashes).
2. Press SET. The min./max./difference values are displayed alternately (5).
3. If desired, press and hold the SET button for 2 seconds to reset the currently (!) displayed value (6).
4. Press ESC. The status display is shown.
5. Repeat steps 1 to 4 if necessary.

You access the settings menu as follows:

- ▶ Press and hold SET for 2 seconds (7). The settings menu appears.

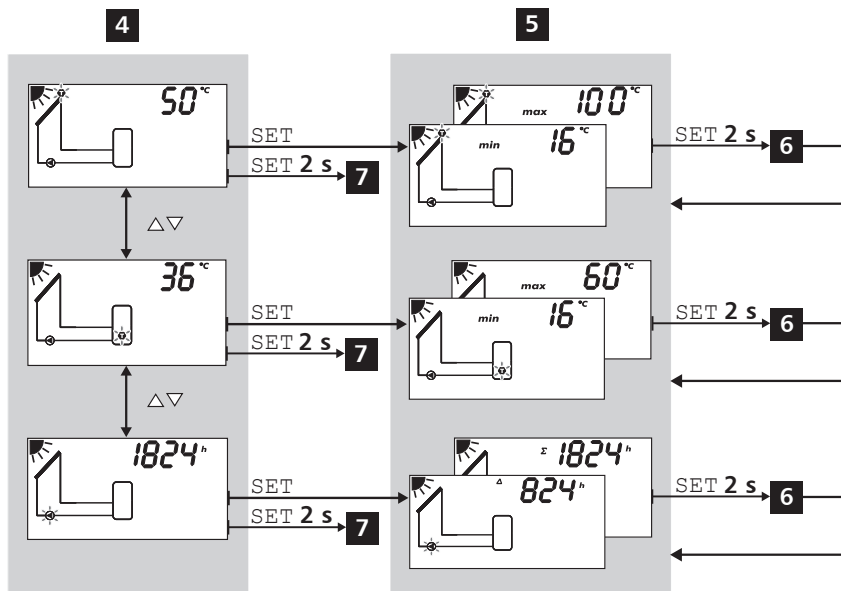

## 8 Settings menu

### 8.1 Overview

The following graphic provides an overview of the structure of the settings menu.

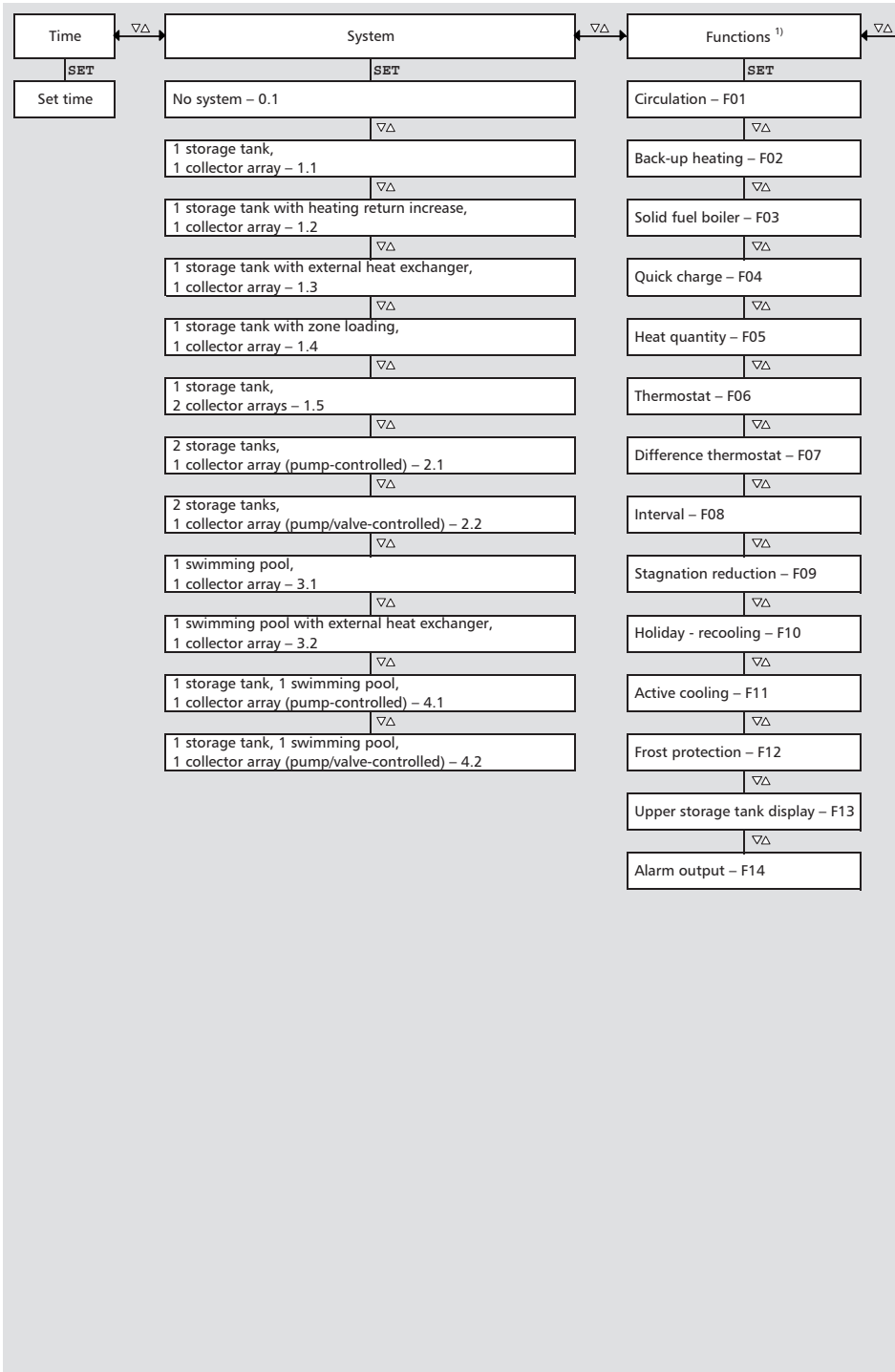



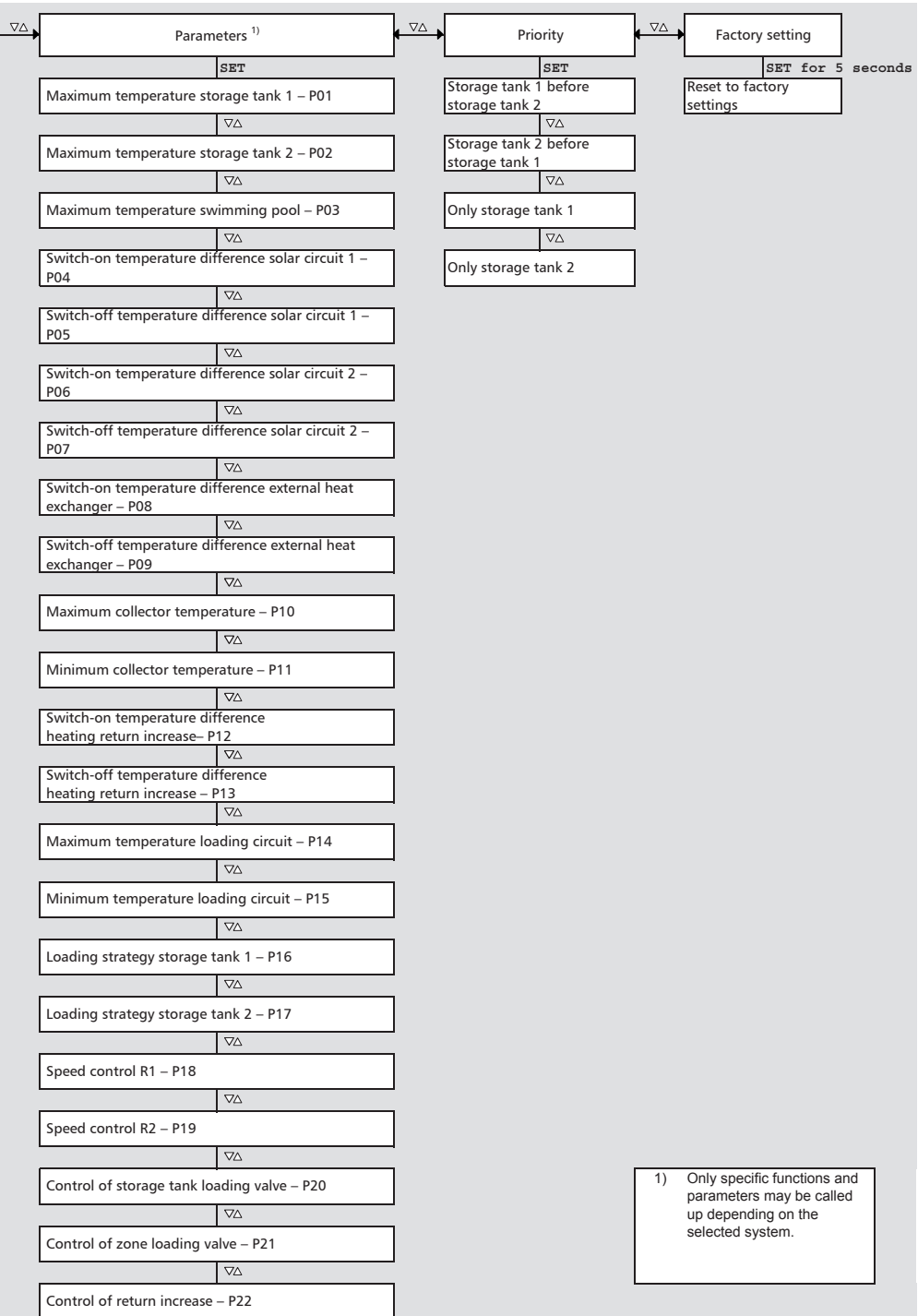

1) Only specific functions and parameters may be called up depending on the selected system.

## 8.2 Calling up the settings menu and selecting a menu entry

✓ Automatic or Off mode is selected.

1. Press and hold **SET** for two seconds. The settings menu is displayed, menu entry  flashes.
2. Press  $\Delta/\nabla$  to select a different menu entry.
3. Change the settings as described in the following sections.

## 8.3 Setting the time

### Note

The time must be once more set to the correct values if power is removed for a longer period of time. After this, the same operating mode is displayed as was active previous to the removal of power.

✓  flashes.

1. Press **SET**. The hours display flashes.
2. Press  $\Delta/\nabla$  to change the hour.
3. Press **SET**. The minutes flash.
4. Press  $\Delta/\nabla$  to change the minute.
5. Press **SET**. The change is adopted.

## 8.4 Setting the system

### Note

The systems are described in Section 3.4, p. 10.

✓ **Syst** flashes.

1. Press **SET**. The number of the current system flashes.
2. Press  $\nabla/\Delta$  to select another system.
3. Press **SET**. The change is adopted.

## 8.5 Setting the functions

✓ **Func** flashes.

- ▶ Continue as described in Section 9, p. 28.

## 8.6 Setting the parameters

### Note

Details on the parameters are provided in Section 10, p. 43.

✓ **Para** flashes.

1. Press **SET**. P:01 (parameter number) flashes.
2. Press  $\Delta/\nabla$  to display a different parameter.
3. Press **SET**. The value of the parameter is displayed, associated components flash in the system graphics.
4. Press **SET**. The parameter value flashes.
5. Press  $\Delta/\nabla$  to change the value.
6. Press **SET** to adopt the change.
7. Press **ESC**. The parameter number is displayed (flashing).
8. If necessary, repeat steps 2 – 7.

## 8.7 Setting the priority

### Functionality

The priority determines the sequence in which the storage tanks are loaded (only for systems with more than 1 storage tank). If the higher priority storage tank (first-priority storage tank) cannot be loaded because the collector temperature is too low then the lower priority storage tank (second-priority storage tank) is loaded <sup>1)</sup>. The following values can be selected:

- 1-: Only storage tank 1 is loaded.
- 2-: Only storage tank 2 is loaded.
- 1-2: Storage tank 1 is the first-priority storage tank.
- 2-1: Storage tank 2 is the first-priority storage tank.

<sup>1)</sup> Every 30 minutes, the controller checks to see if the first-priority storage tank can be loaded. Due to the warming of the collector array this check can take several minutes. On the basis of the heating process, the controller predicts whether it is possible to load the first-priority storage tank in a foreseeable period of time.

### Operation

✓ **Prio** flashes.

1. Press **SET**. The current value flashes.
2. **△▽** - Press to change the priority. The system graphics change accordingly.
3. Press **SET**. The change is adopted.

## 8.8 Resetting to factory defaults

✓  flashes, **RESET** is displayed (**RE** and **SET** alternately).

1. Press and hold **SET** for 5 seconds.
2. A progress display is shown for a few seconds. After this the reset is finished.
3. Continue as described in Section 4, p. 13.

## 9 Functions

### 9.1 Operation

#### Displaying the functions

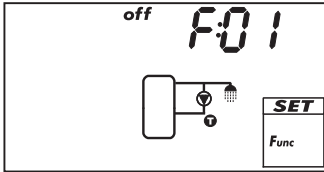

The following information is visible when the functions are displayed:

- Function number, e.g. F:01 (Fig. left)
- Switching state:
  - on: Function is activated
  - off: Function is deactivated (Fig. left)

#### Note

If neither on nor off are displayed then the function cannot be used. Possible causes:

- The set system does not allow the use of this function.
- All outputs are used.

You display the functions as follows:

✓ **Func** flashes.

1. Press SET. F:01 flashes.
2.  $\Delta \nabla$  - Press to display the next function.

#### Activating the function

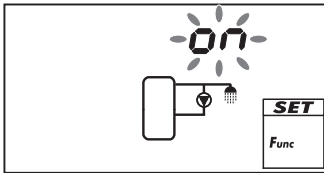

A function must be activated (activation = on) and all the associated characteristics must be correctly set before it can be used. If a function is activated and then exited before the characteristics are set then OFF flashes briefly (Fig. left). After this, the function is displayed with a switching state of off (function is deactivated).

You activate a function as follows:

✓ Function number flashes.

1. Press SET. The function is selected.
2. Press SET. OFF flashes.
3.  $\Delta \nabla$  - Press. on flashes.
4. Press SET. The function is activated.
5. Set the characteristics as described below.

## Setting the characteristics

The functions have different numbers of characteristics. The characteristic values are always set via the same sequence of operating steps.

You set the values of characteristics as follows:

- ✓ The function has been activated as described previously.
- 1.  $\triangle \nabla$  - Press to select a characteristic.
- 2. Press **SET**. The value of the characteristic is displayed, the associated components flash in the system graphics.
- 3.  $\triangle \nabla$  - Press to change the value.
- 4. Press **SET** to adopt the change.
- 5. Repeat steps 1 to 4 for the other characteristics.
- 6. Press **ESC** when all characteristics of the function have been set. The function number flashes.

## 9.2 Characteristics

The main characteristics for the functions are described below. The figures show examples.

### Output

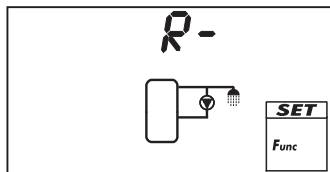

When a function should control an output, instead of the factory setting **R-** (= no output; Fig. left), one of the outputs **R1**, **R2** or **R<sub>S</sub>** must be selected. Only free outputs are displayed for selection.

### Temperature control

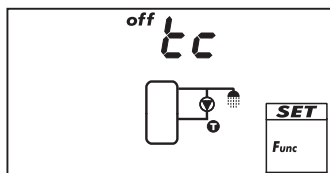

When a function is to be temperature controlled, the temperature control must be switched on (**tc** = temperature control). In the figure, the temperature control is switched off (**off**).

### Input

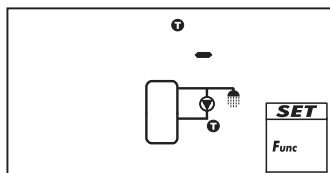

When a function requires a temperature sensor, a sensor input must be selected instead of the factory setting. The factory setting is "**T-**" (no input; Fig. left).

All sensor inputs are displayed for selection. A single sensor input can be simultaneously used by several functions.

### Switch-on temperature difference

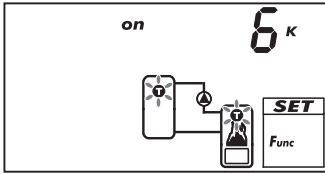

If a function contains a differential thermostat then the switch-on temperature difference can be set. The relevant sensor symbols flash.

### Switch-off temperature difference

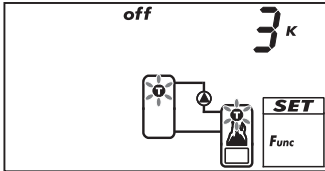

If a function contains a differential thermostat then the switch-off temperature difference can be set. The relevant sensor symbols flash.

### Switch-on temperature

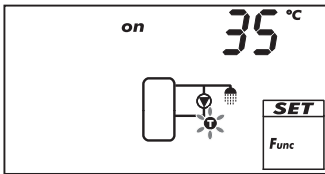

If a function contains a thermostat then the switch-on temperature can be set. The relevant sensor symbol flashes.

### Switch-off temperature

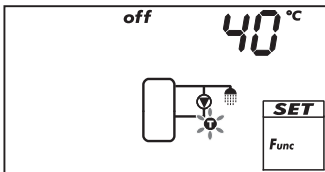

If a function contains a thermostat then the switch-off temperature can be set. The relevant sensor symbol flashes.

### Time control

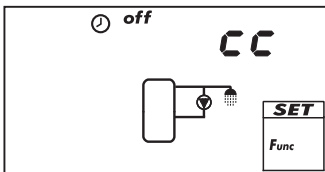

If a function is to be time controlled then the time control must be activated and the time windows must be set (CC = clock control). In the Fig. at the left the time control is switched off (off).

### Starting time of a time window

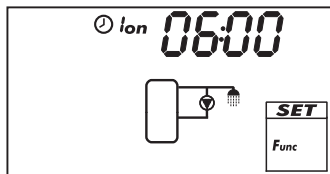

When setting the start time of a time window, the following is displayed to the left of the start time (see Fig. left):

- 
- Number of time window 1 ... 3, whose start time is to be set (in this case: 1)
- on

### End time of a time window

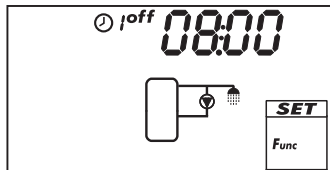

When setting the end time of a time window, the following is displayed to the left of the end time (see Fig. left):

- 
- Number of time window 1 ... 3, whose end time is to be set (in this case: 1)
- off

#### Note

The start time always lies *before* the end time! When an attempt is made to set a start time that is later than the end time, the end time is automatically adjusted.

## 9.3 Function descriptions

The tables in this section describe the function characteristics as follows:

- The *rows* contain the characteristics in the same sequence as they appear on the display.
- The *columns* contain the following information, from left to right:

Column	Description
Display	Sample display when setting the characteristics.
Characteristic	Designation of the characteristics and their interdependence. Dependent characteristics can only be selected and set when the higher level characteristic has the value on. This is shown as follows: <ul style="list-style-type: none"> <li>• Higher-level characteristic: <b>bold text</b></li> <li>• Dependent characteristics: indented to the right below the higher level characteristic</li> </ul> Example: In the table for the <i>circulation</i> function, the sensor input, switch-on temperature and switch-off temperature characteristics are only displayed when the temperature control is set to on.
min., max., factory default setting	Lower (min.) and upper limit (max.) of a characteristic range and the factory setting. When a value range only contains a few values then these are individually listed. Example: on, oFF.

### 9.3.1 Circulation

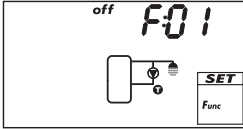

Switches a circulation pump on and off on a temperature and/or time controlled basis.

**Temperature control:** If the temperature in the circulation return falls below the  $T_{on}$  value, then the circulation pump is switched on until the  $T_{off}$  temperature is reached.

**Time control:** The circulation pump is switched on when the current time lies within one of 3 configurable time windows.

**Temperature and time control:** The circulation pump is switched on when the switch-on conditions for the temperature *and* time control are satisfied.

#### Note

Install the circulation sensor at least 1.5 m away from the storage tank to avoid false measurements due to heat conduction of the pipes.

Display	Characteristic	min.	max.	Factory setting
	<b>Activation</b>	on, oFF		oFF
	Output (circulation pump)	free output R1/R2/R <sub>3</sub>		–
	Pump type (R1, R2 only)	AC, HE <sup>1)</sup>		AC
	Pump characteristic (HE only)	AA, Ab, C (see page p. 16)		–
	<b>Temperature control</b>	on, oFF		oFF
	Sensor input for circulation return temperature sensor	1 ... 5		–
	Switch-on temperature $T_{on}$	0 °C	$T_{off} - 2$ K	30 °C
	Switch-off temperature $T_{off}$	$T_{on} + 2$ K	95 °C	35 °C
	<b>Time control</b>	on, off		off
	Time window 1 start/end	0:00	23:59	6:00/8:00
	Time window 2 start/end	0:00	23:59	12:00/13:30
	Time window 3 start/end	0:00	23:59	18:00/20:00

1)

#### Notice

Standard pump: Set **AC**!

High-efficiency pump: Set **HE**!

External relay: Set **AC** pump type!



### 9.3.2 Back-up heating

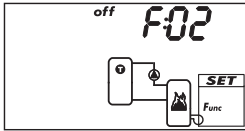

Performs temperature-dependent switching of an output for heating a storage tank using an oil or gas burner. The function can be time restricted.

**Temperature control:** If the temperature in the storage tank falls below the  $T_{on}$  value, then the external heating is switched on until the  $T_{off}$  temperature is reached.

**Time restriction:** The function is executed when the current time lies within one of 3 configurable time windows.

Display	Characteristic	min.	max.	Factory setting
	<b>Activation</b>	on, oFF		oFF
	Output (external heating)	free output R1/R2/R <sub>g</sub>		–
	Pump type (R1, R2 only)	AC, HE <sup>1)</sup>		AC
	Pump characteristic (HE only)	AA, Ab, C (see page p. 16)		–
	Sensor input for readiness part of the storage tank	1 ... 5		–
	Switch-on temperature $T_{on}$	0 °C	$T_{off} - 2$ K	55 °C
	Switch-off temperature $T_{off}$	$T_{on} + 2$ K	95 °C	60 °C
	<b>Time restriction</b>	on, oFF		oFF
	Time window 1 start/end	0:00	23:59	6:00/8:00
	Time window 2 start/end	0:00	23:59	12:00/13:30
	Time window 3 start/end	0:00	23:59	18:00/20:00

1)

#### Notice

Standard pump: Set **AC**!

High-efficiency pump: Set **HE**!

External consumer (e.g. 230 V relay): Set **AC** pump type.

### 9.3.3 Solid fuel boiler

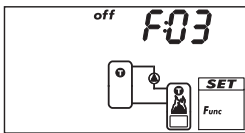

Controls a pump in order to heat a storage tank using a solid fuel boiler. The pump is switched on when all of the following conditions are satisfied at the same time:

- The temperature difference between the solid fuel boiler and the storage tank exceeds  $T_{diff\ on}$ .
- The solid fuel boiler temperature lies above the *min. solid fuel boiler temperature*.
- The storage tank temperature lies below the *max. storage tank temperature*.

The pump is switched off when one the following conditions is satisfied:

- The temperature difference between the solid fuel boiler and the storage tank drops below  $T_{diff\ off}$ .
- The solid fuel boiler temperature drops below the *min. solid fuel boiler temperature*.
- The storage tank temperature reaches the *max. storage tank temperature*.

Speed control of the pump can be activated as required. The loading strategy of the speed control system attempts to regulate the temperature of the solid fuel boiler to match the control target that has been set. The control target should be at least 10 K above the minimum temperature of the solid fuel boiler.

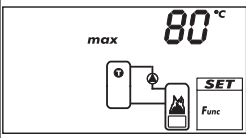
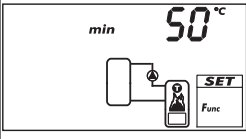
Display	Characteristic	min.	max.	Factory setting
	<b>Activation</b>	on, oFF		oFF
	Output (pump)	free output R1/R2/R <sub>s</sub>		–
	Pump type (R1, R2 only)	AC, HE <sup>1) 2)</sup>		AC
	Pump characteristic (HE only)	AA, Ab, C (see page p. 16)		–
	<b>Speed control</b> (R1, R2 only)	on, oFF <sup>2)</sup>		oFF
	Minimum speed (AC only)	30%	100%	50%
	Minimum speed (HE + AA only)	0%	100%	25%
	Minimum speed (HE + Ab only)	0%	100%	75%
	Sensor input for storage tank temperature	1 ... 5		–
	Sensor input for solid fuel boiler temperature	1 ... 5		–
	Switch-on temperature difference T <sub>diff on</sub>	T <sub>diff off</sub> + 2 K	20 K	6 K
	Switch-off temperature difference T <sub>diff off</sub>	0 K	T <sub>diff on</sub> – 2 K	3 K
	Max. storage tank temperature	0 °C	150 °C	60 °C
	Min. solid fuel boiler temperature	30 °C	95 °C	50 °C
	Control target for solid fuel boiler temperature (Speed control = on)	0 °C	95 °C	60 °C

1)

**Notice**Standard pump: Set **AC**!High-efficiency pump: Set **HE**!

2)

**Notice**External consumer (e.g. 230 V relay): Set **AC** pump type and set the speed control to **oFF**!

### 9.3.4 Quick charging

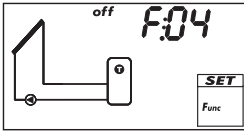

Uses a higher loading temperature to load the the upper region of the storage tank more quickly in order to provide early prevention of back-up heating by the conventional heating system. To do this, the loading strategy of the first-priority storage tank is changed from differential loading to absolute temperature loading as soon as the temperature in the upper tank region drops below  $T_{on}$ <sup>\*)</sup>. At the same time, an attempt is made to achieve a higher temperature in the storage tank by using the speed control.

<sup>\*)</sup> To retain the proven quick charging functionality , when  $T_{on}$  is changed the value of  $T_{off}$  is changed in parallel.

#### Note

To use the *quick charge* function, the speed control must be switched on; more information on this is provided in Section 10, p. 43 (P18, P19).

Display	Characteristic	min.	max.	Factory setting
	<b>Activation</b>	on, oFF		oFF
	Sensor input for upper storage tank temperature	1 ... 5		-
	Switch-on temperature $T_{on}$	0 °C	85 °C	50 °C
	Switch-off temperature $T_{off}$	$T_{on} + 2$ K	$T_{on} + 10$ K	52 °C

### 9.3.5 Heat quantity

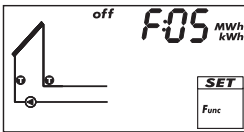

Calculates the acquired heat volume based on the following information:

- Supply temperature
- Return temperature
- Flow rate volume determined via calculations based on the pump speed or by pulse water meter measurements (terminal 5).

#### Note

Calculation based on the pump speed cannot be performed when *No system* (system 0.1) has been selected.

- Glycol proportion and accounting for the temperature dependent thermophysical properties of the heat transfer fluid

Additional possibility: Display of the amount of CO<sub>2</sub> saved by using the system. The amount of CO<sub>2</sub> is calculated from the acquired heat volume. To do this, the controller requires the conversion factor  $g_{CO_2}/kWh_{therm}$  to be entered.

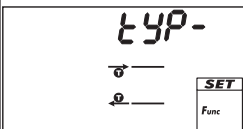
Display	Characteristic	min.	max.	Factory setting
	<b>Activation</b>	on, oFF		oFF
	<b>Type of flow rate acquisition</b>	tyP 1, tyP 2 <sup>1)</sup>		-

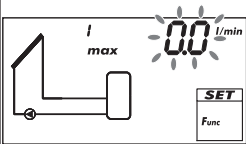
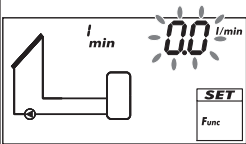
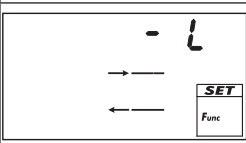
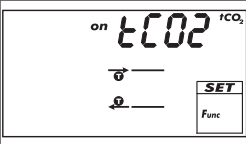
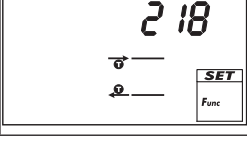
	Type 1: Flow rate value at max. speed $F_{\max}$ . (pump 1). When the Fig. at the left is displayed (value flashes) then enter the value read from the flow rate display.	$F_{\min}$ .	99.9 l/min	0.0 l/min
	Type 1: Flow rate value at min. speed $F_{\min}$ . (pump 1). When the Fig. at the left is displayed (value flashes) then enter the value read from the flow rate display.	0.0 l/min	$F_{\max}$ .	0.0 l/min
	Type 1: Flow rate value at max. speed $F_{\max}$ . (pump 2) <sup>2)</sup>	$F_{\min}$ .	99.9 l/min	0.0 l/min
	Type 1: Flow rate value at min. speed $F_{\min}$ . (pump 2) <sup>2)</sup>	0.0 l/min	$F_{\max}$ .	0.0 l/min
	Type 2: Flow rate of the pulse water meter in litres/pulse; see the pulse water meter data sheet.	1L, 10L, 25L		-L (no flow rate value selected)
	Glycol proportion	0%	60%	40%
	Supply sensor input (warm)	1 ... 5		-
	Return sensor input (cold)	1 ... 5		-
	CO <sub>2</sub> display	on, oFF		oFF
	$g_{\text{CO}_2}/\text{kWh}_{\text{therm}}$	1	999	218 <sup>3)</sup>

1) tYP 1: Calculation of the flow rate from the pump speed. To do this, the displayed flow rate values are entered at two measuring points (pump speed min. and max.).

tYP 2: Determining the flow rate using a pulse water meter. The flow rate of the pulse water meter in litres/impulse is entered.

2) Only for systems with 2 pumps. Enter the displayed flow rate values at  $F_{\max}/F_{\min}$ . in the same manner as with type 1, pump 1.

3) Source: Erneuerbare Energien in Zahlen – Nationale und internationale Entwicklung (Renewable energy sources in figures - national and international development), p. 20, as of: June 2010; Federal Ministry for the Environment, Nature Conservation and Nuclear Safety (BMU)

### 9.3.6 Thermostat

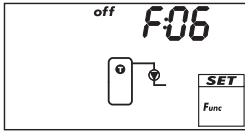

Switches an output on and off, depending on the temperature range of any desired sensor. The function can be time restricted and is set for heating or cooling as follows:

**Heating:** The  $T_{on}$  value is set lower than  $T_{off}$ .

When the sensor temperature drops below  $T_{on}$ , the output is switched on until the temperature exceeds  $T_{off}$ .

**Cooling:** The  $T_{on}$  value is set higher than  $T_{off}$ .

When the sensor temperature exceeds  $T_{on}$ , the output is switched on until the temperature drops below  $T_{off}$ .

**Time restriction:** The function is executed when the current time lies within one of 3 configurable time windows.

#### Note

The  $T_{on}$  value can be set to the same value as  $T_{off}$ . However, this setting has no practical application.

Display	Characteristic	min.	max.	Factory setting
	<b>Activation</b>	on, oFF		oFF
	Output	free output R1/R2/R <sub>s</sub>		-
	Pump type (R1, R2 only)	AC, HE <sup>1)</sup>		AC
	Pump characteristic (HE only)	AA, Ab, C (see page p. 16)		-
	Sensor input	1 ... 5		-
	Switch-on temperature $T_{on}$	0 °C	180 °C	20 °C
	Switch-off temperature $T_{off}$	0 °C	180 °C	20 °C
	<b>Time restriction</b>	on, oFF		oFF
	Time window 1 start/end	0:00	23:59	00:00/00:00
	Time window 2 start/end	0:00	23:59	00:00/00:00
	Time window 3 start/end	0:00	23:59	00:00/00:00

1)

#### Notice

Standard pump: Set **AC**!

High-efficiency pump: Set **HE**!

External consumer (e.g. 230 V relay): Set **AC** pump type!

### 9.3.7 Differential thermostat

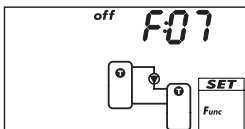

Switches an output on and off as follows – time restricted and depending on the set temperature difference between 2 selectable sensors:

When the temperature difference exceeds  $T_{diff on}$ , the output is switched on until the temperature difference drops below  $T_{diff off}$ . In addition to this, the discharging of the heating source can be limited to a particular temperature range ( $T_{src min.}/T_{src max.}$ ) and the loading of the heating target can be limited to a maximum value ( $T_{sink max.}$ ).

**Time restriction:** The function is executed when the current time lies within one of 3 configurable time windows.

Speed control of the pump can be activated as required. The loading strategy of the speed control system attempts to regulate the temperature difference to match the switch-on temperature difference that has been set.

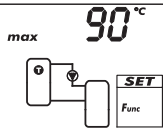
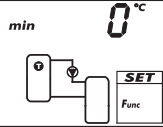
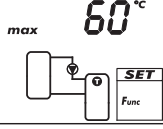
Display	Characteristic	min.	max.	Factory setting
	<b>Activation</b>	on, oFF		oFF
	Output	free output R1/R2/R <sub>s</sub>		–
	Pump type (R1, R2 only)	AC, HE <sup>1) 2)</sup>		AC
	Pump characteristic (HE only)	AA, Ab, C (see page p. 16)		–
	<b>Speed control</b> (R1, R2 only)	on, oFF <sup>2)</sup>		oFF
	Minimum speed (AC only)	30%	100%	50%
	Minimum speed (HE + AA only)	0%	100%	25%
	Minimum speed (HE + Ab only)	0%	100%	75%
	Heat source sensor input	1 ... 5		–
	Heat sink sensor input	1 ... 5		–
	Switch-on temperature difference T <sub>diff on</sub>	T <sub>diff off</sub> + 2 K	80 K	6 K
	Switch-off temperature difference T <sub>diff off</sub>	0 K	T <sub>diff on</sub> – 2 K	3 K
	Heat source max. temperature T <sub>src max.</sub>	T <sub>src min.</sub> + 2 K	180 °C	100 °C
	Heat source min. temperature T <sub>src min.</sub>	0 °C	T <sub>src max.</sub> – 2 K	0 °C
	Heat sink max. temperature T <sub>sink max.</sub>	0 °C	95 °C	60 °C
	<b>Time restriction</b>	on, oFF		oFF
	Time window 1 start/end	0:00	23:59	00:00/00:00
	Time window 2 start/end	0:00	23:59	00:00/00:00
	Time window 3 start/end	0:00	23:59	00:00/00:00

1)

**Notice**Standard pump: Set **AC**!High-efficiency pump: Set **HE**!

2)

**Notice**External consumer (e.g. 230 V relay): Set **AC** pump type and set the speed control to **oFF**!

### 9.3.8 Interval

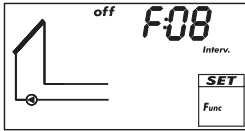

Periodically switches the solar circuit pump on and off in order to measure the actual collector temperature. The delay between 2 switch-on operations and the switch-on duration can be set. Applications:

- Collector types where the mechanical construction prevents the temperature from being measured at a suitable place
  - Unsuitable position of the temperature sensor on the collector
- The function can be time restricted to prevent unnecessary periodic operation at night.

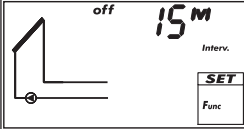
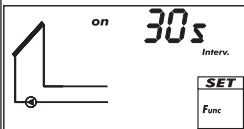
Display	Characteristic	min.	max.	Factory setting
	<b>Activation</b>	on, oFF		oFF
	Time window start/end	00:00	23:59	08:00/19:00
	Wait time	1 min	999 min	15 min
	Switch-on duration	3 s	999 s	5 s

### 9.3.9 Stagnation reduction

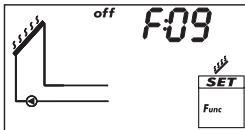

Delays the end of the storage tank's loading phase in order to reduce, or even to avoid, the system standstill (stagnation) times at high temperatures. To do this, the pump is stopped repeatedly, and only briefly switched on again at high collector temperatures. Since the efficiency drops heavily at high collector temperatures, the loading takes longer and possible stagnation occurs later.

#### Note

This function cannot be activated in systems with swimming pools.

Display	Characteristic	min.	max.	Factory setting
	<b>Activation</b>	on, oFF		oFF

### 9.3.10 Holiday - recooling

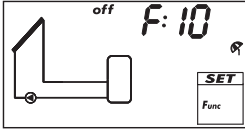

Attempts to reduce, or even to avoid, the system standstill (stagnation) times at high temperatures. To do this, at night the storage tank – or the second-priority storage tank if 2 storage tanks are present – is discharged as far as possible to the set minimum temperature, if the storage tank temperature during the day was 10 K below the set maximum temperature.

Stagnation occurs when not enough hot water is removed from the system during an absence (holiday).

#### Notes

The following applies to this function:

- Only activate if you intend to be absent for an extended period.
- Deactivate this after returning from a holiday in order to avoid an unnecessary waste of energy via the collector circuit.
- This function cannot be activated in systems with swimming pools.

Display	Characteristic	min.	max.	Factory setting
	<b>Activation</b>	on, oFF		oFF
	Minimum storage tank temperature	0 °C	95 °C	35 °C

### 9.3.11 Active cooling

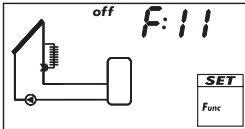

Switches an additional cooler into the solar circuit when one of the following conditions is satisfied:

- The temperature of the storage tank – or of the second-priority storage tank in the case of 2 storage tanks – lies 10 K below the set maximum temperature.
- Holiday recooling is performed at night.

Application examples: Areas with strong solar irradiation, avoidance of stagnation.

Display	Characteristic	min.	max.	Factory setting
	<b>Activation</b>	on, oFF		oFF
	Output (switching-in of additional cooler)	free output R1/R2/R <sub>S</sub>		-



### 9.3.12 Frost protection

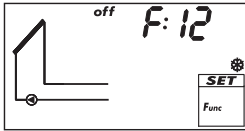

Attempts to prevent freezing of the collectors by pumping heat from the first-priority storage tank into the collectors:

- The collector temperature is below +5 °C: Solar circuit pump is switched on.
- The collector temperature is above +7 °C: Solar circuit pump is switched off.

The frost protection function is only useful when the heat transfer fluid contains insufficient or no anti-freeze. It is recommended to generally use heat transfer fluid with anti-freeze!

#### Notice

Despite the frost protection function being activated, the solar system can freeze under the following conditions:

- The first-priority storage tank is unloaded, a back-up heating system is not present.
- Heat transfer fluid contains insufficient or no anti-freeze.
- Power outage
- Unsuitable position of the temperature sensor on the collector
- Collector sensor or cable is broken or has a short.circuit.
- The collectors are installed in a position exposed to the wind.
- Solar circuit pump is faulty.

Display	Characteristic	min.	max.	Factory setting
	Activation	on, OFF		OFF

### 9.3.13 Upper storage tank display

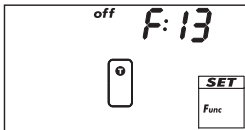

Shows the temperature in the upper region of 1 or 2 storage tanks. For this, an appropriate sensor must be connected to each tank. The measured temperatures are not used for control purposes.

Display	Characteristic	min.	max.	Factory setting
	Activation	on, OFF		OFF
	Storage tank 1 upper sensor input	1 ... 5		–
	Storage tank 2 upper sensor input <sup>1)</sup>	1 ... 5		–

<sup>1)</sup> Only for systems with 2 storage tanks

### 9.3.14 Alarm output

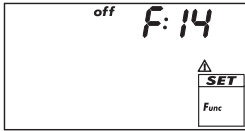

- Activates the set output in the case of the following faults:
- Sensor fault due to short-circuit or interruption
  - Clock loses the current time due to an extended power outage.
  - Volume flow fault: Er: 1 <sup>1)</sup>
  - The electronic overload switch or fuse has triggered: Er: 3 ...  
Er: 6 <sup>1)</sup>

Display	Characteristic	min.	max.	Factory setting
	<b>Activation</b>	on, OFF		OFF
	Output	free output R1/R2/Rs		-
	Control	norm, InV <sup>2)</sup>		norm

<sup>1)</sup> More information is provided in Section 13.2, p. 48.

<sup>2)</sup> norm = normal: Contact closes when a fault occurs.  
InV = inverted: Contact opens when a fault occurs.

## 10 Parameters



Note the following when setting parameters:

- Observe the operating data of the solar components used.
- The individual parameters are only displayed and can be changed when this is permitted by the type of solar system that has been set.  
Special case: System 0.1 has no parameters, nOP is displayed.
- In most applications the controller can be used without modifying any parameters.

More information is provided in the *Functionality* column.

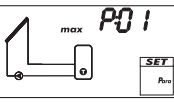
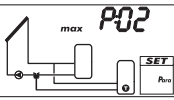
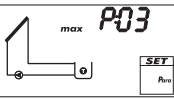
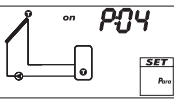
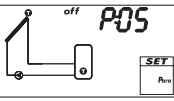
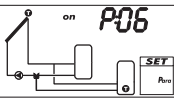
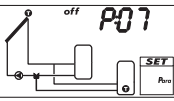
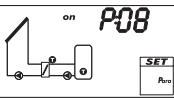
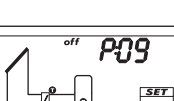
The figures in this section show examples.

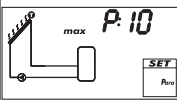
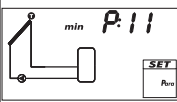
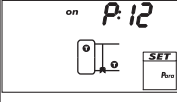
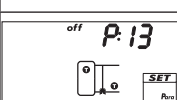
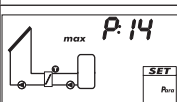
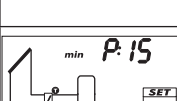
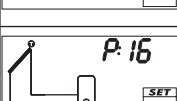
Display	Parameter	min.	max.	Factory setting	Functionality
	Maximum temperature storage tank 1	0 °C	95 °C	60 °C	When the maximum temperature is exceeded, no more loading occurs until the temperature drops to 3 K below the set value.
	Maximum temperature storage tank 2	0 °C	95 °C	60 °C	
	Maximum temperature swimming pool	10 °C	45 °C	30 °C	
	Switch-on temperature difference solar circuit 1	$T_{P05} + 2 \text{ K}$	50 K	8 K	When the switch-on temperature difference between collector and storage tank is reached, the storage tank is loaded.
	Switch-off temperature difference solar circuit 1	0 K	$T_{P04} - 2 \text{ K}$	4 K	Loading ends when the switch-off temperature difference is reached.
	Switch-on temperature difference solar circuit 2	$T_{P07} + 2 \text{ K}$	50 K	8 K	When the switch-on temperature difference between the secondary side of the external heat exchanger and the storage tank is reached, the storage tank is loaded.
	Switch-off temperature difference solar circuit 2	0 K	$T_{P06} - 2 \text{ K}$	4 K	
	Switch-on temperature difference external heat exchanger	$T_{P09} + 2 \text{ K}$	50 K	6 K	
	Switch-off temperature difference external heat exchanger	0 K	$T_{P08} - 2 \text{ K}$	3 K	Loading ends when the switch-off temperature difference is reached.

Display	Parameter	min.	max.	Factory setting	Functionality
	Maximum collector temperature	$T_{P11} + 20 \text{ K}$	$180 \text{ }^\circ\text{C}$	$130 \text{ }^\circ\text{C}$	When the maximum collector temperature is exceeded, no more loading occurs until the temperature drops to 3 K below the set value.
	Minimum collector temperature	$0 \text{ }^\circ\text{C}$	$T_{P10} - 20 \text{ K}$	$0 \text{ }^\circ\text{C}$	Load only starts when the minimum collector temperature is exceeded.
	Switch-on temperature difference heating return increase	$T_{P13} + 2 \text{ K}$	$50 \text{ K}$	$6 \text{ K}$	The heating return increase is switched on (switching valve on) when the switch-on temperature difference between the storage tank and heating return temperature is reached.
	Switch-off temperature difference heating return increase	$0 \text{ K}$	$T_{P12} - 2 \text{ K}$	$3 \text{ K}$	When the switch-off temperature difference is reached, the heating return increase is switched off.
	Maximum temperature loading circuit	$T_{P15} + 20 \text{ K}$	$130 \text{ }^\circ\text{C}$	$100 \text{ }^\circ\text{C}$	The difference between P14 and the temperature of the secondary side of the heat exchanger controls the solar circuit pump and the storage tank loading pump. <sup>1)</sup>
	Minimum temperature loading circuit	$0 \text{ }^\circ\text{C}$	$T_{P14} - 20 \text{ K}$	$0 \text{ }^\circ\text{C}$	The storage tank loading pump is only switched on when the secondary side of the heat exchanger is greater than or equal to P15.
	Loading strategy storage tank 1	$dIFF^2)$ , $AbS$		<sup>3)</sup>	The loading strategy depends on the storage tank system used and the usage of the system. <i>diff</i> : Highest efficiency. The control target is the temperature difference between the collector and the storage tank. <sup>4)</sup> <i>AbS</i> : Useful when the system requires particular temperatures, e.g. to avoid switching on the external back-up heating system. The control target is the temperature of the collector. <sup>4)</sup>
	Control target of differential temperature loading ( <i>dIFF</i> )	$2 \text{ K}$	$50 \text{ K}$	$8 \text{ K}$	
	Control target of absolute temperature loading ( <i>AbS</i> )	$0 \text{ }^\circ\text{C}$	$95 \text{ }^\circ\text{C}$	$60 \text{ }^\circ\text{C}$	
	Loading strategy storage tank 2	$dIFF^2)$ , $AbS$		<sup>3)</sup>	
	Control target of differential temperature loading ( <i>dIFF</i> )	$2 \text{ K}$	$50 \text{ K}$	$8 \text{ K}$	
	Control target of absolute temperature loading ( <i>AbS</i> )	$0 \text{ }^\circ\text{C}$	$95 \text{ }^\circ\text{C}$	$60 \text{ }^\circ\text{C}$	

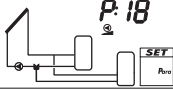
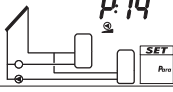
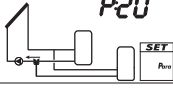
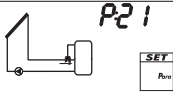
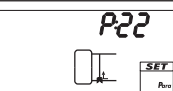
Display	Parameter	min.	max.	Factory setting	Functionality
	Pump type R1	AC, HE		AC	<b>Notice</b> Danger of malfunctions in the controller or damage to the components. HE <b>must</b> be set when using a high-efficiency pump and AC <b>must</b> be set when using a standard pump! Set speed control to OFF when an external relay is connected or speed control is not wanted.
	Pump characteristic (HE only)	AA, Ab, C (see p. 16)		-	
	Speed control (R1, R2 only)	on, OFF		OFF	
	Minimum speed (AC only)	30%	100%	50%	
	Minimum speed (HE + AA only)	0%	100%	25%	
	Minimum speed (HE + Ab only)	0%	100%	75%	
	Pump type R2	AC, HE		AC	
	Pump characteristic (HE only)	AA, Ab, C (see p. 16)		-	
	Speed control (R1, R2 only)	on, OFF		OFF	
	Minimum speed (AC only)	30%	100%	50%	
	Minimum speed (HE + AA only)	0%	100%	25%	
	Minimum speed (HE + Ab only)	0%	100%	75%	
	Control of the storage tank loading valve	norm, InV		norm	norm (normal) must be set when the valve has been installed according to the installation instructions in Section 3.4, p. 10. InV (inverted) must be set when the valve has been installed in a <i>different</i> way compared to the installation instructions.
	Control of the zone loading valve	norm, InV		norm	
	Control of the return increase	norm, InV		norm	

Tab. 3: Parameters

- When the secondary side of the heat exchanger reaches 3 K below P14, the *solar circuit pump* is switched off. At 10 K below P14 the solar circuit pump is switched on again. When the secondary side of the heat exchanger reaches P14, the *storage tank loading pump* is switched off. Below P14, the storage tank loading pump is switched on again.
- diff is defined as a fixed value for swimming pools.
- The factory setting depends on the system that has been set.
- The pump speed is adjusted accordingly to achieve the control target.

## 11 Deinstallation and disposal



### Danger

Risk of death by electrocution!

- Disconnect the device from the power supply before opening the casing.
- All work on an open device must be performed by professional personnel.

1. To dismantle the controller, follow the installation instructions in the reverse order; see Section 3, p. 5.
2. Dispose of the device in accordance with the local regulations.

## 12 Information messages

Display	Description
	<p>The maximum collector temperature has been reached, the solar circuit pump in the respective solar circuit has been switched off.</p> <p>The symbols in the status display flash when the temperature of the respective collector is selected</p>
	<p>The maximum collector temperature has been reached, the solar circuit pump in the respective solar circuit has been switched off.</p> <p> is shown in the status display when the temperature of the respective collector is <i>not</i> selected.</p>
	<p>The maximum storage tank temperature has been reached.</p> <p>The symbols in the status display flash when the temperature of the respective collector is selected.</p>

Tab. 4: Information messages

## 13 Troubleshooting



### Danger

Risk of death by electrocution!







- Immediately disconnect the device from the mains supply when it can no longer be operated safely, e.g. in the case of visible damage.
- Disconnect the device from the mains power before opening the case.
- All work on an open device must be performed by professional personnel.

### Notes

The controller is a quality product, conceived for years of continuous trouble-free operation. Observe the following points:

- Faults are often caused by connected components and not by the controller.
- The following notes on fault identification indicate the most common causes of faults.
- Only return the controller when you are absolutely sure that none of the problems listed below is responsible for the fault.

## 13.1 General faults

Display	Possible cause	Remedy
<b>Controller not functioning at all</b>		
Display empty/ dark	Controller power supply is interrupted.	<ul style="list-style-type: none"> <li>• Check the controller power cable.</li> <li>• Check the fuse for the power supply.</li> </ul>
<b>Controller constantly displays 12:00</b>		
12 flashes	Controller power supply was interrupted for longer than 15 minutes.	Set the time.
<b>Solar circuit pump not operating + switch-on condition is fulfilled</b>		
	Pump power supply is interrupted.	Check the pump power cable.
	Pump has seized up.	Get the pump working again, replace if necessary.
	<ul style="list-style-type: none"> <li>• The maximum storage tank temperature has been reached.</li> <li>• The maximum collector temperature has been reached.</li> <li>• In multi storage tank systems: The system has stopped due to a priority test.</li> <li>• The minimum collector temperature has not been reached.</li> <li>• The maximum loading temperature has been reached.</li> <li>• Stagnation reduction is activated and is actively intervening in the control process.</li> <li>• The storage tank has been deactivated in the priority settings.</li> </ul>	No fault
 flashes 	Pump has been switched off in <code>manual mode (off)</code> .	<ul style="list-style-type: none"> <li>• No fault</li> <li>• Switch to <code>automatic mode</code> if necessary.</li> </ul>
<b>Solar circuit pump is operating + switch-on condition not fulfilled</b>		
	<ul style="list-style-type: none"> <li>• The following functions are activated and are actively intervening in the control process: <ul style="list-style-type: none"> <li>– Interval function</li> <li>– Holiday function</li> <li>– Anti-freeze function</li> </ul> </li> <li>• Blockage protection for the pumps is being performed.</li> </ul>	<ul style="list-style-type: none"> <li>• No fault</li> <li>• Deactivate the relevant function, if necessary.</li> </ul>
 flashes 	Pump has been switched on in <code>manual mode (on)</code> .	<ul style="list-style-type: none"> <li>• No fault</li> <li>• Switch to <code>automatic mode</code> if necessary.</li> </ul>

Solar circuit pump is operating + switch-on condition is fulfilled but no heat transport in the solar circuit (no heat transfer fluid circulation)		
	Air is in the solar circuit.	Check the solar circuit for air.
	The isolating valve is closed.	Check the isolating valve.
	Limescale or contamination in solar circuit	Clean the solar circuit (flush).
Solar circuit pump shows cycle behaviour		
	Temperature difference too small	Adjust temperature difference in the <i>Parameters</i> settings menu.
	Collector sensor incorrectly positioned	Check the position of the collector sensor and correct if necessary.

Tab. 5: General faults

## 13.2 Error messages

When an error message is displayed and no button has been pressed for 5 minutes, the backlighting turns red and starts flashing.

The figures in this section show examples.

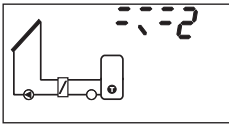
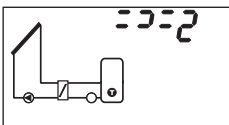
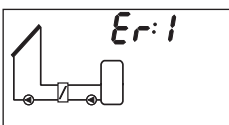
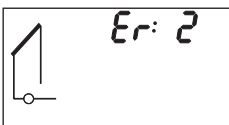
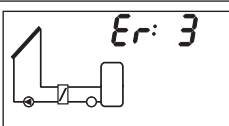
Display	Description	Remedy
	An interruption was detected at the displayed sensor input (in this case: sensor input 2).	Check the cable and sensor connected to the sensor input.
	A short-circuit was detected at the displayed sensor input (in this case: sensor input 2).	Check the cable and sensor connected to the sensor input.
	The controller has detected a flow rate fault in the primary or secondary circuit. A permanently high temperature difference exists between the heat source and loading target. Primary and secondary circuit pumps are flashing. Possible causes: <ul style="list-style-type: none"> <li>• Air in system</li> <li>• The isolating valve is closed.</li> <li>• The pump is faulty.</li> </ul>	<ul style="list-style-type: none"> <li>• Bleed air from the system.</li> <li>• Check the isolating valve.</li> <li>• Check the pump.</li> </ul>
	The controller has detected faulty operation of the system. This is probably caused by swapped collector connections.	Check the collector connections.
	A short-circuit exists at output R1, the pump connected to output R1 flashes. Possible causes: <ul style="list-style-type: none"> <li>• The pump is faulty.</li> <li>• Wiring fault</li> </ul>	<ul style="list-style-type: none"> <li>• Check the pump.</li> <li>• Check the wiring to R1.</li> </ul>

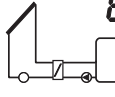
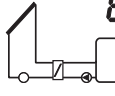

 <p><b>Er: 4</b></p>	<p>Output R1 is overloaded, the pump connected to output R1 flashes. Cause: The permissible values for R1 specified on the type plate have been permanently exceeded, the output has been switched off.</p>	<p>Check the electrical data of the pump, replace pump if necessary. R1 is automatically switched on again.</p>
 <p><b>Er: 5</b></p>	<p>A short-circuit exists at output R2, the pump connected to output R2 flashes. Possible causes:</p> <ul style="list-style-type: none"> <li>• The pump is faulty.</li> <li>• Wiring fault</li> </ul>	<ul style="list-style-type: none"> <li>• Check the pump.</li> <li>• Check the wiring to R2.</li> </ul>
 <p><b>Er: 6</b></p>	<p>Output R2 is overloaded, the pump connected to output R2 flashes. Cause: The permissible values for R2 specified on the type plate have been permanently exceeded, the output has been switched off.</p>	<p>Check the electrical data of the pump, replace pump if necessary. R2 is automatically switched on again.</p>

Tab. 6: Error messages

### 13.3 Checking the Pt1000 temperature sensors



#### Danger

Risk of death by electrocution! Before opening the device, make sure that all cables leading to the device have been disconnected from the mains power and cannot be unintentionally reconnected to the mains power.

1. Remove the terminal cover.
2. Disconnect the temperature sensor.
3. Measure the resistance of the temperature sensor with an ohmmeter and compare with the following table. Small deviations are acceptable.
4. Mount the terminal cover.

#### Temperature – Resistance assignments

Temperature [°C]	-30	-20	-10	0	10	20	30	40	50	60	70
Resistance [Ω]	882	922	961	1000	1039	1078	1117	1155	1194	1232	1271
Temperature [°C]	80	90	100	110	120	130	140	150	160	170	180
Resistance [Ω]	1309	1347	1385	1423	1461	1498	1536	1573	1611	1648	1685

Tab. 7: Temperature-resistance assignment with Pt1000 temperature sensors

## 14 Technical data

### 14.1 Controller

Inputs/outputs									
Rated voltage (system voltage)	115 ... 230 V~, 50/60 Hz								
Own consumption	≤ 0.8 W, two Pt1000 temperature sensors connected								
Outputs R1, R2	<table border="0"> <tr> <td style="text-align: right;">Quantity</td> <td>2</td> </tr> <tr> <td style="text-align: right;">Type</td> <td>TRIAC</td> </tr> <tr> <td style="text-align: right;">Switching current</td> <td>1.1 (1.1) A each</td> </tr> <tr> <td style="text-align: right;">Voltage</td> <td>115 ... 230 V~, 50/60 Hz</td> </tr> </table>	Quantity	2	Type	TRIAC	Switching current	1.1 (1.1) A each	Voltage	115 ... 230 V~, 50/60 Hz
Quantity	2								
Type	TRIAC								
Switching current	1.1 (1.1) A each								
Voltage	115 ... 230 V~, 50/60 Hz								
Signal inputs/outputs									
Signal inputs 1 ... 5	<table border="0"> <tr> <td style="text-align: right;">Quantity</td> <td>5</td> </tr> <tr> <td style="text-align: right;">Type of signal inputs 1 ... 4</td> <td>Pt1000 (temperature acquisition)</td> </tr> <tr> <td style="text-align: right;">Type of signal input 5</td> <td> <ul style="list-style-type: none"> <li>• Pt1000 (temperature acquisition) or</li> <li>• pulse water meter using 1 l/pulse, 10 l/pulse or 25 l/pulse (flow rate acquisition)</li> </ul> </td> </tr> </table>	Quantity	5	Type of signal inputs 1 ... 4	Pt1000 (temperature acquisition)	Type of signal input 5	<ul style="list-style-type: none"> <li>• Pt1000 (temperature acquisition) or</li> <li>• pulse water meter using 1 l/pulse, 10 l/pulse or 25 l/pulse (flow rate acquisition)</li> </ul>		
Quantity	5								
Type of signal inputs 1 ... 4	Pt1000 (temperature acquisition)								
Type of signal input 5	<ul style="list-style-type: none"> <li>• Pt1000 (temperature acquisition) or</li> <li>• pulse water meter using 1 l/pulse, 10 l/pulse or 25 l/pulse (flow rate acquisition)</li> </ul>								
Signal output R <sub>S</sub>	<table border="0"> <tr> <td style="text-align: right;">Type</td> <td>potential-free NO contact</td> </tr> <tr> <td style="text-align: right;">Max. contact load</td> <td>1 (0) A, 24 V</td> </tr> </table>	Type	potential-free NO contact	Max. contact load	1 (0) A, 24 V				
Type	potential-free NO contact								
Max. contact load	1 (0) A, 24 V								
Signal outputs PWM R1, PWM R2	<table border="0"> <tr> <td style="text-align: right;">Type</td> <td>PWM, 250 Hz, 11 V</td> </tr> <tr> <td style="text-align: right;">Max. load</td> <td>10 mA</td> </tr> </table>	Type	PWM, 250 Hz, 11 V	Max. load	10 mA				
Type	PWM, 250 Hz, 11 V								
Max. load	10 mA								
Hydraulic schemes (systems)									
Quantity	11								
Display									
Type	LCD display with backlighting								
Application conditions									
Degree of protection	IP 22, DIN 40050 [without front panel: IP 20]								
Protection class	I								
Ambient temperature	0 ... +50 °C, when wall-mounted								
Physical specifications									
Dimensions L x W x H	110 x 160 x 51 mm								
Weight	350 g								
Software class	A								
Type of action	type 1.Y								
Type of fastening for permanently connected cables	type X								
Degree of pollution	2								
Ball pressure test temperature	casing pan: 125 °C other casing parts: 75 °C								
Overvoltage category	class II (2500 V)								

Tab. 8: Technical controller data

## 14.2 Cable specifications

Mains cable	
Mains cable type	H05 VV... (NYM...)
External diameter of mantle	6.5 mm to 10 mm
Conductor cross-section	
single strand (solid)	≤ 2.5 mm <sup>2</sup>
fine strand (with core end sleeves)	≤ 1.5 mm <sup>2</sup>
Diameter of the internal strain relief	6.5 mm to 10 mm
Signal cable	
Sensor cable length	≤ 100 m, including extension
Sensor extension cable	
design	twisted-pair conductors for lengths > 10 m
cross-section of each conductor	0.75 mm <sup>2</sup> for lengths < 50 m 1.50 mm <sup>2</sup> for lengths > 50 m

Tab. 9: Cable specifications

### Exclusion of liability

The manufacturer can neither monitor the compliance with this manual nor the conditions and methods during the installation, operation, usage and maintenance of the controller. Improper installation of the system may result in damage to property and, as a result, to bodily injury.

Therefore, the manufacturer assumes no responsibility and liability for loss, damage or costs which result from or are in any way related to incorrect installation, improper operation, incorrect execution of installation work and incorrect usage and maintenance. Similarly, we assume no responsibility for patent right or other right infringements of third parties caused by usage of this controller.

The manufacturer reserves the right to make changes to the product, technical data or installation and operating instructions without prior notice.

### Legal guarantee

In accordance with German statutory regulations, there is a 2-year legal guarantee on this product for the customer.

The seller will remove all manufacturing and material faults that occur in the product during the guarantee period and affect the correct functioning of the product. Natural wear and tear does not constitute a malfunction. No legal guarantee can be offered if the fault can be attributed to third parties, unprofessional installation or commissioning, incorrect or negligent handling, improper transport, excessive loading, use of improper equipment, faulty construction work, unsuitable construction location or improper operation or use. Legal guarantee claims shall only be accepted if notification of the fault is provided immediately after it is discovered. Guarantee claims are to be directed to the seller.

**The seller must be informed before guarantee claims are processed. For processing a guarantee claim an exact fault description and the invoice / delivery note must be provided.**

The seller can choose to fulfil the legal guarantee either by repair or replacement. If the product can neither be repaired nor replaced, or if this does not occur within a suitable period in spite of the specification of an extension period in writing by the customer, the reduction in value caused by the fault shall be replaced, or, if this is not sufficient taking the interests of the end customer into consideration, the contract is cancelled.

Any further claims against the seller based on this guarantee obligation, in particular claims for damages due to lost profit, loss-of-use or indirect damages are excluded, unless liability is obligatory by law.



742886