

# **E-Print 202 / 202 Wireless**

**Miniature Thermal Printer**



## **Operation Manual**

**V1.01**

# Operation Manual

## E-Print 202 / 202 wireless Miniature Thermal Printer

Please read this operation manual before operating the printer. If, however, you should find details that are not consistent when handling the system, please send us a brief comment to enable us to rectify the inconsistencies.

This is subject to modifications owing to further optical or technical developments that contrast to the data and illustrations contained in these operating instructions.

All trademarks quoted in the text and reproduced are trademarks of the respective proprietor and are acknowledged to be protected.

<p style="text-align: center;"><b>Manufactured by</b></p> <p style="text-align: center;">Shenzhen Envisen Industry Co. Limited</p> <p>2nd Floor, Block 1, 40 Jianlong Street, Baoan Community, Heng Gang Town, Long Gang District, Shenzhen, China</p> <p style="text-align: center;">Zip : 518115 Tel: +86 755 88827227 Fax: +86 755 28604953</p>	<p style="text-align: center;"><b>Distributed by</b></p> <p style="text-align: center;">EnviteC Wismar GmbH a Honeywell Company</p> <p style="text-align: center;">Alter Holzhafen 18 D-23966 Wismar, Germany Tel. +49-(0)-3841-360-1 Fax.+49-(0)-3841-360-222 <a href="mailto:info@envitec.com">info@envitec.com</a> - <a href="http://www.envitec.com">www.envitec.com</a></p>
--	--

# Contents

- 1. Introduction.....4
- 2. Contents of Package.....4
- 3. Symbols .....4
- 4. Product Safety .....5
  - 4.1 Product Safety.....5
  - 4.2 Battery Safety.....5
  - 4.3 Charger Safety.....6
- 5. Getting Started .....6
  - 5.1 Keys and Parts .....6
  - 5.2 Light and Tone Indication.....7
  - 5.3 Battery Charging .....8
- 6. Basics.....10
  - 6.1 Power On .....10
  - 6.2 Power Off .....10
  - 6.3 Load the paper .....11
  - 6.4 Printing a test page .....13
  - 6.5 Test page information .....14
  - 6.6 Communication.....15
- 7. Preventive Maintenance .....17
  - 7.1 General maintenance instructions.....17
  - 7.2 Replacing the battery.....18
  - 7.3 Recycling .....19
  - 7.4 Warranty .....20
- 8. Specifications.....21
- 9. Troubleshooting.....23
- 10. Copyright and other notices.....24













## 1. Introduction

Thank you for purchasing the E-print 202 miniature thermal printer. This small, portable device can print via a cable or using wireless data communication technology. This Operation Manual covers both user operation and also user maintenance of the E-print 202. For technical service information, please refer to the **Technical Manual**.

## 2. Contents of Package

1 x E-print 202 / 202 wireless printer	1 x RS232C Data Cable
1 x Rechargeable Lithium Battery	1 x Paper Roll
1 x Mains Charger	1 x Operation Manual
1 x Car Charger	

## 3. Symbols

Symbol	Definition of Symbol
	Manufacturer
	Part Number
	Serial Number
	Consult Instructions for Use
	CE Marking: conformance to European Electrical Compatibility Directive 2004/108/EC and European Directive LVD 2006/95/EC.
	Caution and Warning.
	Your device is not water-resistant. Keep it dry.
	Use only batteries, chargers, and other accessories approved by EnviteC for use with this device. Do not connect incompatible products.
	Only qualified personnel may install or repair this product
	Indication Light
	Important!
	Indicates separate collection for electrical and electronic equipment (WEEE).

## 4. Product Safety

### 4.1 Product Safety

 Caution: Do not take apart the printer without permission of the manufacturer, otherwise the warranty service is not guaranteed.

 Caution: Keep the E-Print 202 away from young children. Small items such as the battery door, battery are choking hazards.

 Warning: Please turn off the power once trouble occurs. When you find the printer or charger smoking or giving off smell, please unplug the charge immediately and remove the battery to avoid injuries.

 Warning: Don't use printer near the gas station or fuel depot where easy to get fire.

 Caution: Don't open the paper cover when printing; otherwise it might occur unforeseen circumstances even damage the printer.

 Caution: The printer head will still at high temperature within seconds after printing. Don't touch it to avoid injuries.

 Caution: Do not place the E-Print 202 in liquid or clean it with agents containing ammonium chloride, isopropyl alcohol, or products that are not listed in this User's Guide.

 Caution: Please remove battery if the device will be stored for a long time

 Caution: Turn off the printer before changing battery. If you are using charger, please make sure you have cut off the power before changing battery.

### 4.2 Battery Safety

 Caution: Avoid accidental short circuiting of any battery. Allowing battery terminals to contact conductive material will create a short circuit which could cause burns and other injuries or could start a fire.

 Caution: Batteries can explode or catch fire if improperly charged or exposed to high temperatures or fire. Do not disassemble, crush or expose batteries to water.

 Caution: The device must be used the specified rechargeable battery and charger provided by our company, otherwise it might occur lower performance, device damaged, fire or danger of battery explosion.

⚠ Caution: Risk of explosion if battery is replaced by an incorrect type. Dispose of used batteries according to the instructions.

## 4.3 Charger Safety

⚠ Caution: Do not place a charger in locations where liquids or metallic objects may be dropped on the charger

ⓘ Important: Do not block the ventilating slots on the top and bottom covers. Ensure that the Charger is plugged into a power source which won't accidental be turned off if you will be charging batteries overnight

⚠ Caution: Don't touch the charger with wet hands.

⚠ Caution: Please hand the charger head but not the power cord when plug and unplug the charger.

## 5. Getting Started

### 5.1 Keys and Parts

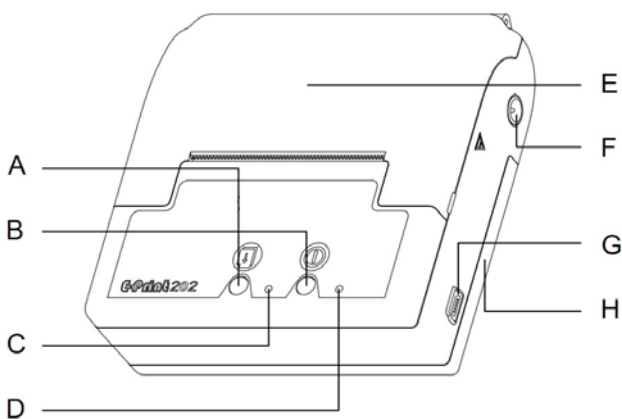

- A: Function button
- B: Power On/Off button
- C: Function indication light
- D: Power indication light
- E: Paper cover
- F: Charge jack  
(DC12V Power connection)
- G: RS232 communication port
- H: Battery cover

## 5.2 Light and Tone Indication

As follow table, Power indication light, function indication light and the tones from buzzer will remind you of different status of E-Print 202 wireless.

Status	Power Indication light	Function Indication light	Buzzer
Power On	Blue LED	-	A Single Beep sound
Power Off	-	-	A Single Beep sound
Data Receiving	Blue LED	Blue LED	-
Data Receive Failure	Blue LED	Red LED flashing	Continuous Beep sounds
Charging	Red LED	-	-
Charging Completed	LED off	-	-
Low Battery	Red LED flashing	-	Continuous Beep sounds
Printing	Blue LED	Red LED	-
Printing Failure	Blue LED	Red LED flashing	Continuous Beep sounds
Out of Paper	Blue LED	Red LED flashing	Continuous Beep sounds

## 5.3 Battery Charging



When the device battery is charging, the red power LED indicator is lit. When the battery is full, the red LED indicator will be switched off.



**Important:** If the printout is not clear, or if the power LED indicator is not lit or both LED indicators are flashing red, the battery might be deep discharged or the power voltage is too low. Please charge immediately and/or check that an appropriate charger is used.

### 5.3.1 Charging from a mains wall outlet

1. First plug the connector jack from the charger into the printer, then connect the charger to the wall outlet.

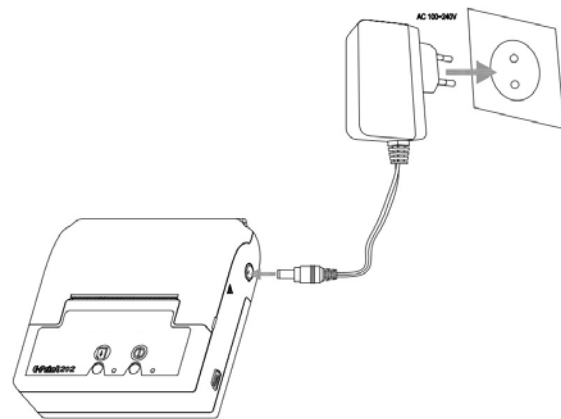



2. When the battery is full, disconnect charger and printer and then disconnect from the mains wall outlet.

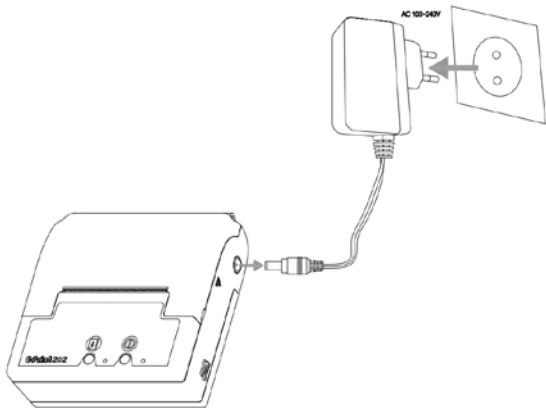

### 5.3.2 Charging from a car

1. First plug the connector jack from the car charger into the printer, then plug the car charger into your car cigarette lighter socket.

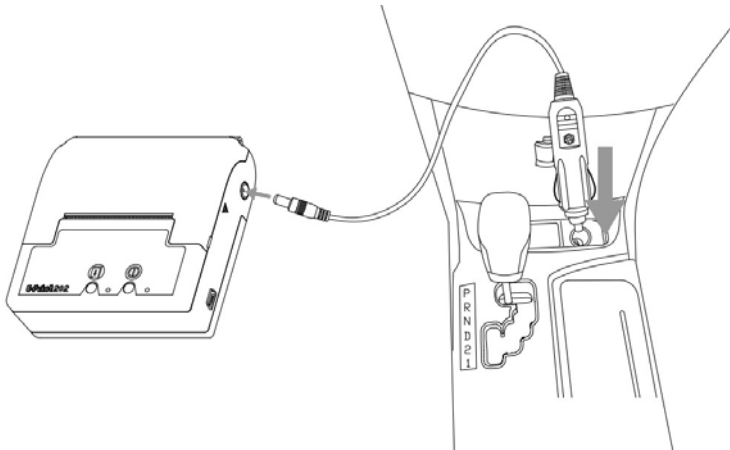

2. When the battery is full, disconnect the charger connector jack from the printer and then disconnect the charger from the car cigarette lighter socket.

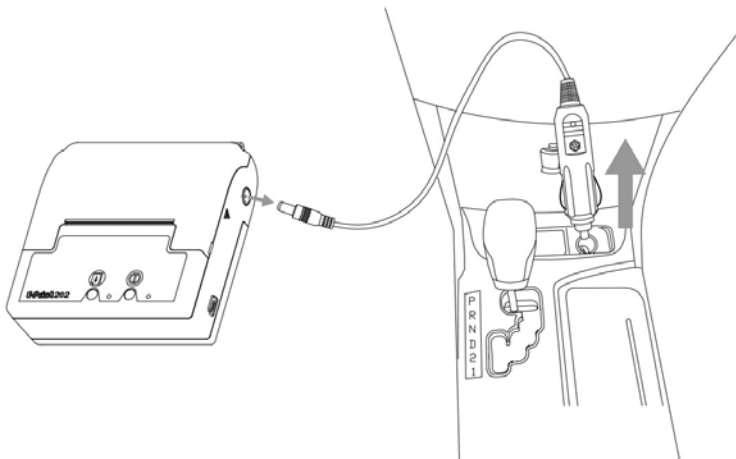

## 6. Basics

### 6.1 Power On

While using the RS232 cable connection, the printer wakes up from standby when print data arrives. It's not required to explicitly switch on the printer.

To switch on, press and hold **Power On/Off** button for 2 seconds.

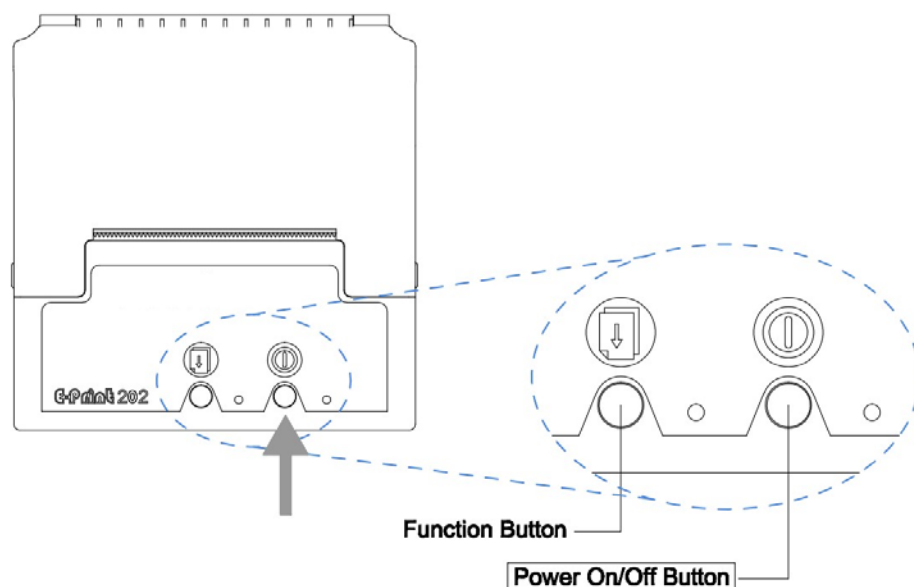

### 6.2 Power Off

Press and hold **Power On/Off** button for 3 seconds to power down the printer.

The printer will switch off automatically when it is idle for 150 seconds.

Switching off the printer when not in use saves battery power.

## 6.3 Load the paper

1. Press and hold the **Power On/Off** button for 2s to turn on the device
2. Press and hold both sides of the printer where the “Push” indication is printed, then pushing in and lift up the paper cover.

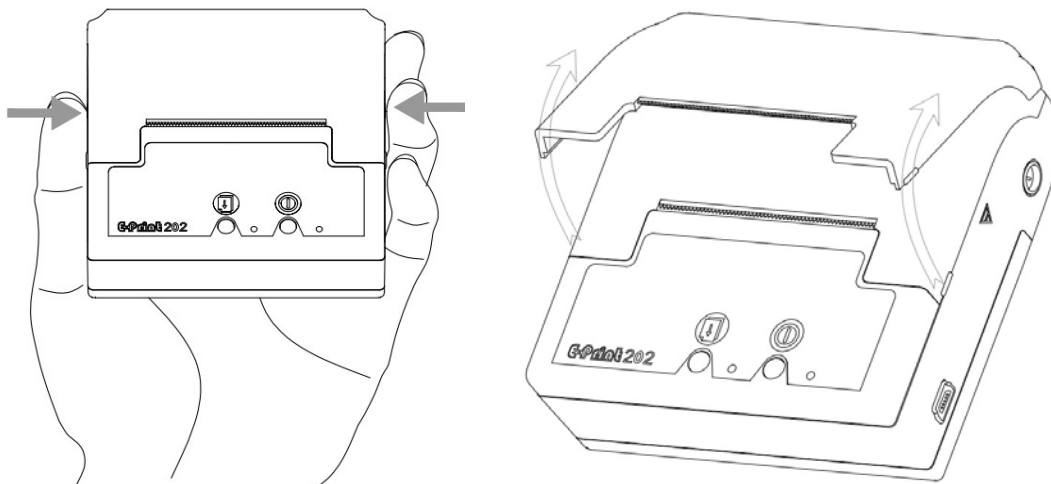

**!** Caution: Do not lift the paper cover without pushing in both side of the printer housing or the cover may be damaged.

3. Insert the paper roll as detailed below; making sure the printing side of the paper roll faces the printing head.

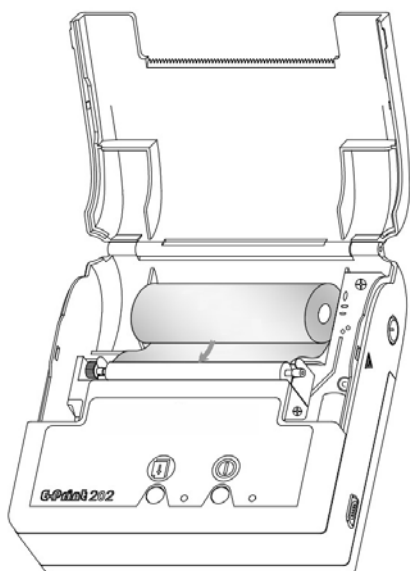

4. Press and hold **Function** button until the paper feed in.

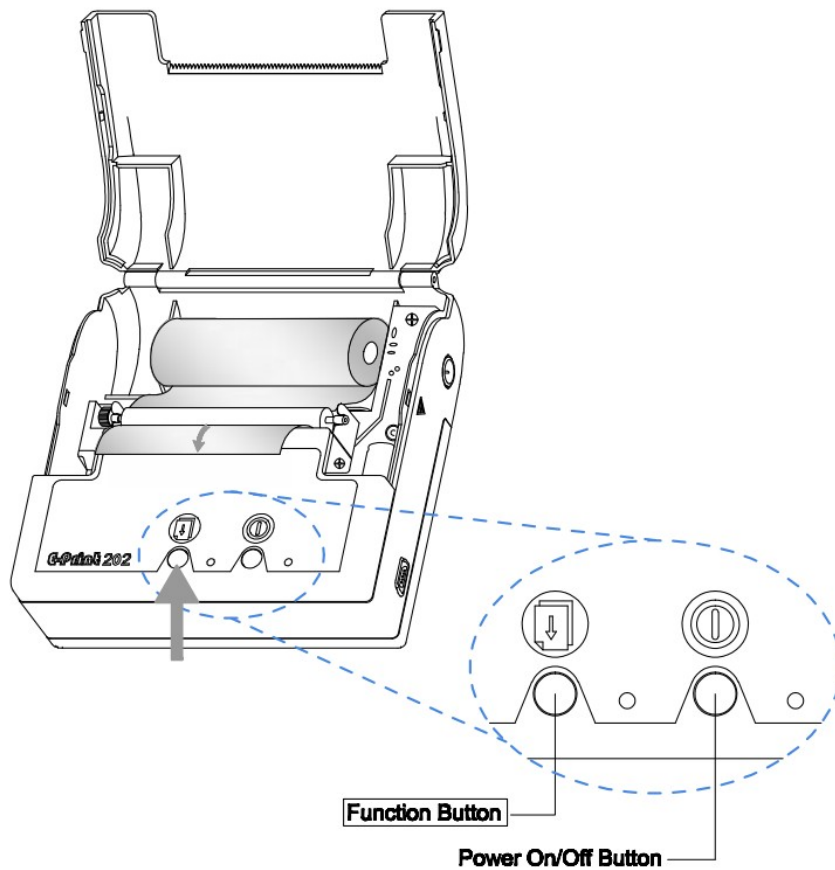

**!** Caution: For proper operation the printing paper must be inserted with the thermal face downwards. If the printer is out of paper during printing, the Red LED function indicator will flash, and there will be a continuous beep alarm.

## 6.4 Printing a test page

1. If your printer is powered on, please turn it off first.
2. Press and hold both **Power On/Off** button and **Function** button for 2 seconds.
3. When the Blue power indicator lights, release **Power On/Off** button and **Function** button.  
The printer is powered on, and the test page is printed out.

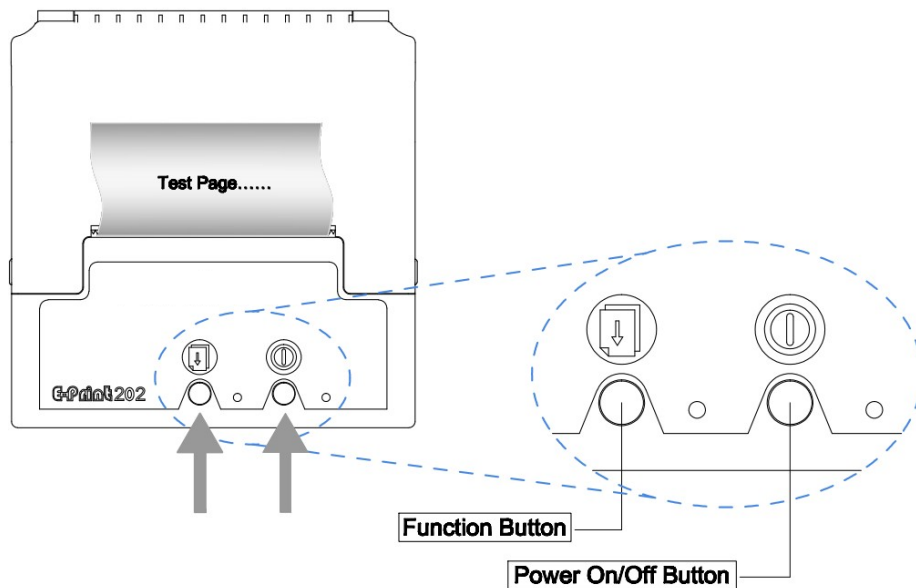

## 6.5 Test page information

Some basic information of E-print 202 is listed on the test page, including firmware version, base configuration and installed fonts etc. Here is an example below:

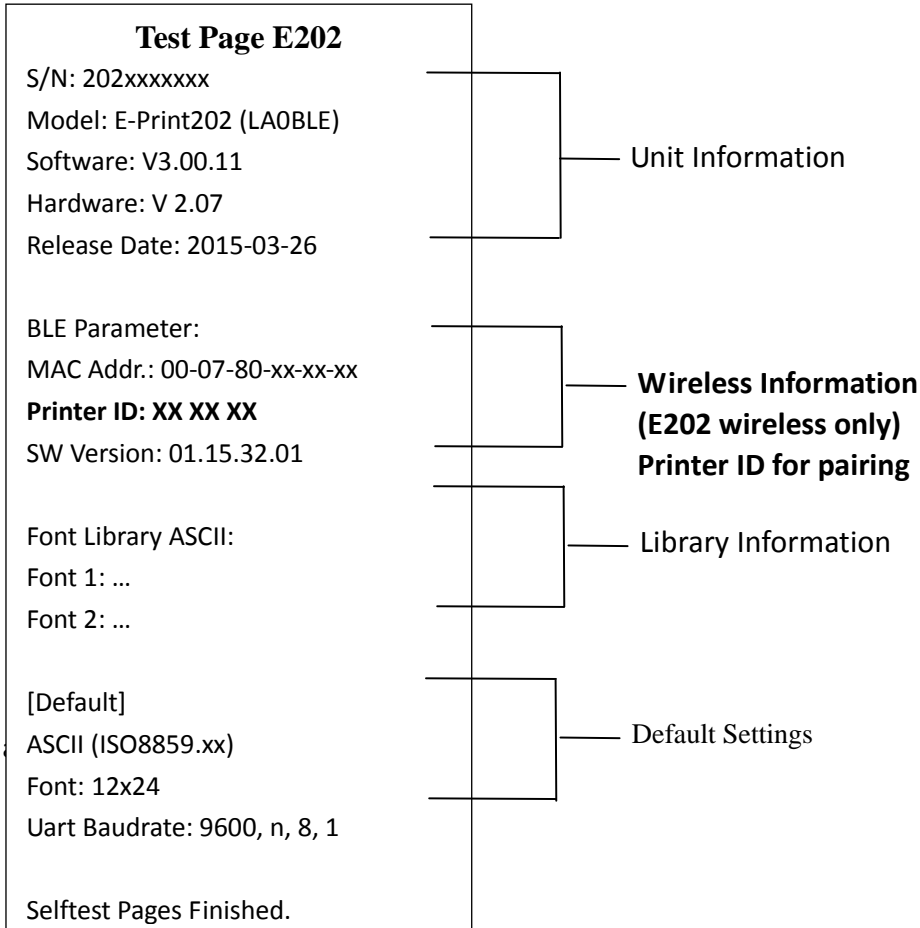

## 6.6 Communication

The E-Print 202 must establish communications with the host device, which then sends the data to be printed.

Communication occurs in two ways:

- Via a cable between the printer and the host device using RS232C
- By means of a wireless communication link (IEEE 802.15.1).

### 6.6.1 RS232C Serial communication

E-print 202 has a combined RS232/USB wired serial port.

1. Plug the 5-pin USB modular connector of your communication cable into the combination RS232 port on the side of printer.
2. The other end of the cable should be plugged into the host device as illustrated below:

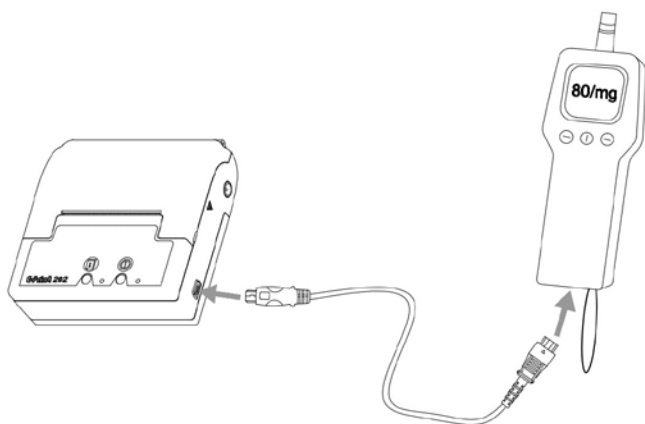



**!** Caution: Do not disconnect the cable during printing; otherwise the printing quality may be affected.

## 6.6.2 Wireless communication (E202 wireless only)

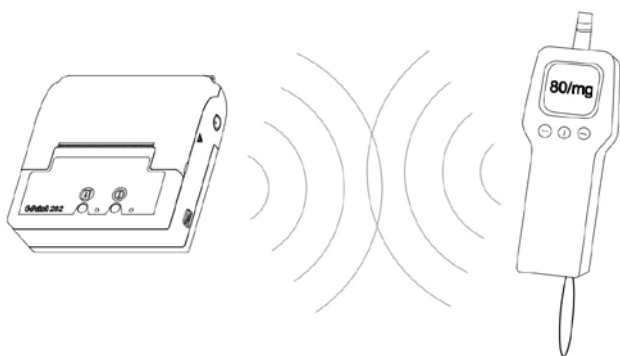
- E-print 202 wireless also incorporates a wireless data interface (IEEE 802.15.1).
- Prior to wireless printing the >Printer ID<, that is found on a label on the E202 wireless, has to be used to connect host device and printer with each other.
- The printer ID can also be acquired by performing a printer self test (→ chapter 6.4 / 6.5 )
- The printing distance between E-print 202 wireless and the host device can be up to 10m if there is a clear line of sight between the devices, with no obstructions.



-  During the data transfer from the device to the printer, the Blue LED function indicator is on. Once the data transfer is completed, the blue LED goes off and the printing starts.
-  If data transfer fails, the Red LED function indicator will start flashing and there will be a continuous audible beep sound.
-  During the printing process, the printer will not respond to any buttons which are pressed.



## 7. Preventive Maintenance

### 7.1 General maintenance instructions

- Always turn the printer off before cleaning
- Cleaning exterior of printer: Wipe with water-dampened or alcohol-dampened cloth.
- Cleaning Interior of printer: Brush/air blow. Ensure the Paper Sensor is free of dust.

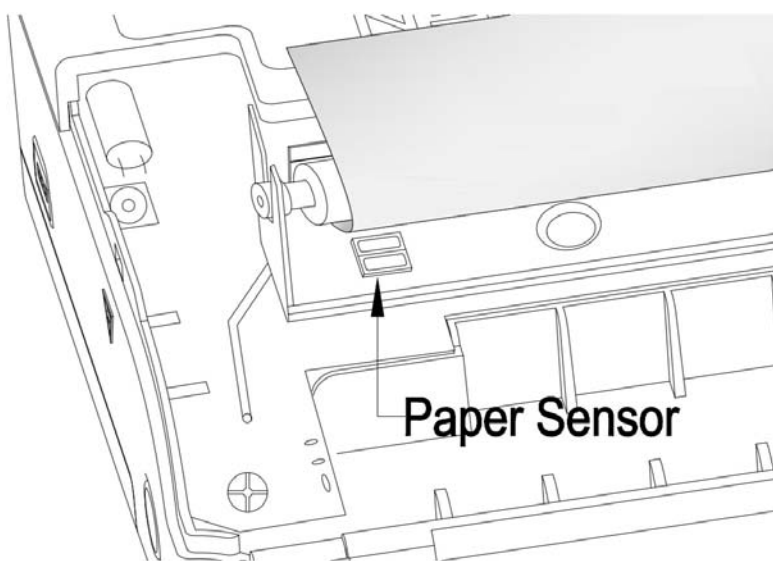

- To avoid possible personal injury or damage to the printer, never insert any pointed or sharp objects into the printer.
- Recommended storing conditions of the battery: 20°C~60°C for 1 month; -20°C~45°C for 3 months; -20°C~20°C for 1 year. Extreme temperatures reduce the capacity and lifetime of the battery. A device with a too hot or too cold battery might not work properly.
- Consider purchasing an extra battery.
- Remember that any rechargeable battery will lose its ability to maintain a charge over time and can be recharged only a finite number of times before it must be replaced.
- Do not use or store the device in dusty or dirty areas. Moving parts and electronic components can easily be damaged.
- Do not store the device in high temperatures. High temperatures can shorten the life of the device, damage the battery, and warp or melt the plastics housings.
- Do not store the device in cold temperatures because moisture can form inside the device and damage electronic circuits when the device warms up to its normal temperature.
- Do not drop, knock, or shake the device. Rough handling can break internal circuit boards and displays etc.

- Keep the device away from magnets or magnetic fields.

## 7.2 Replacing the battery

To replace the battery, please follow below steps:

1. Unscrew the cover then remove the battery cover by pulling and lifting the cover as indicated below.

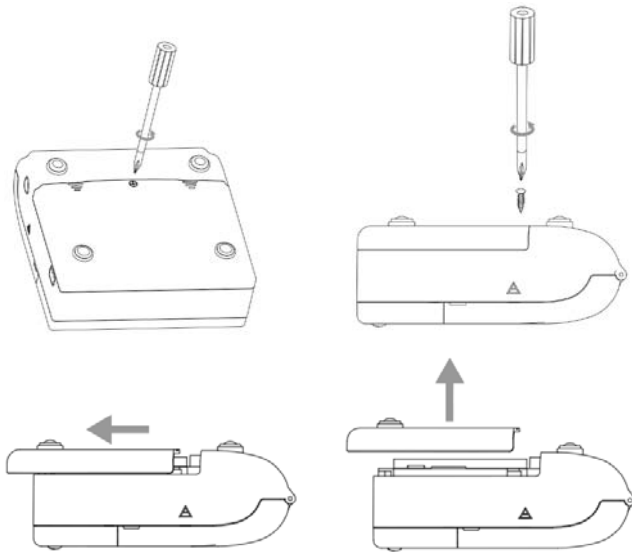

2. Carefully lift the battery up.

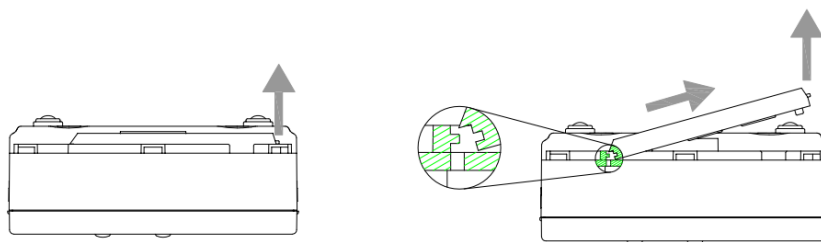

3. Insert the battery pack into the printer, making sure the two grooves of the battery clip are slid accurately into the two clip positions on the inside of the printer case. Check that the metal contact points on the battery face downwards and line up with the metal contact points on the inside of the printer. Then lock the battery in place by pushing down.

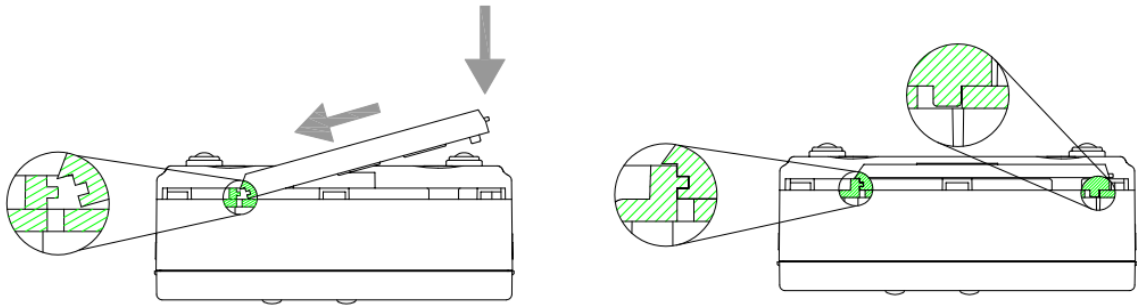

4. Carefully reposition the battery door and slide into place. Do not force the battery door into place; it fits only when positioned correctly.

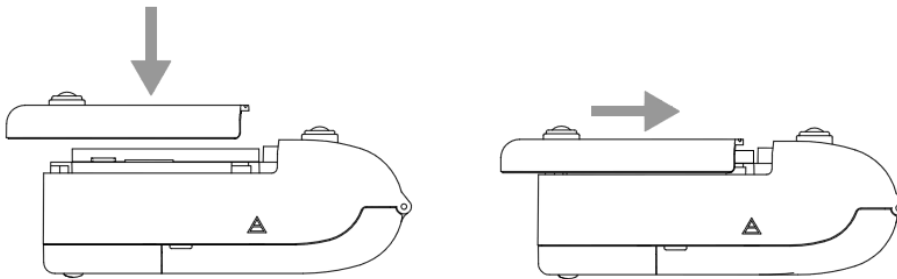

5. Tighten the screw to secure the cover.

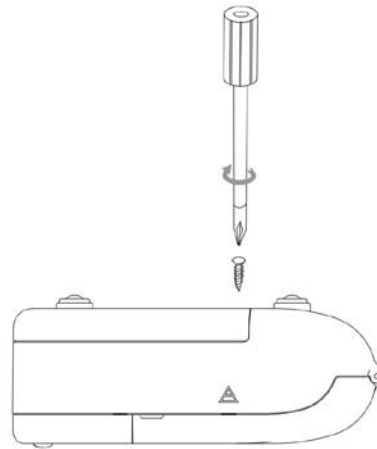

Caution: Always remove the battery if the device will not be used for more than 90 days.

## 7.3 Recycling

Always return your used electronic products, batteries, and packaging materials to dedicated collection points. This way you help prevent uncontrolled waste disposal and promote the recycling of materials.

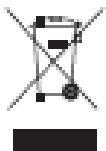

## 7.4 Warranty

As of the purchase date, EnviteC offers a two year warranty for faults arising from material or manufacturing defects. Excepted from this is the battery (see the General Terms of Business).

Faults that are covered by warranty will be corrected within the framework of our warranty conditions. EnviteC offers no warranty if the operator endangers the functioning of the device through failure to heed the operating manual and technical documentation, inappropriate handling, improper use or unauthorized modifications or repair attempts. In these cases, the liability is transferred to the operator!

Transport to customer service and back for repairs not covered under warranty takes place at the customer's expense.

Please contact your dealer if you wish to make a warranty claim!

**To return the unit directly to EnviteC under the warranty, you will need an RMA (Return Material Authorization) number (please always state this number in all of your correspondence!)**

through our website, [www.envitec.com](http://www.envitec.com), under Service / Returns.

Once you have obtained this number, please send the unit along with all accessories to the following address:

**EnviteC-Wismar GmbH**

Service

Alter Holzhafen 18

D-23966 Wismar

Germany

Warranty claims are only accepted on presentation of the purchase receipt!

## 8. Specifications

Model		E-Print 202
<b>Physical specifications</b>		
Dimension	96x100x37 mm (LxWxH)	
Weight	190g (Without paper)	
Paper diameter	≤30mm	
<b>Printing specifications</b>		
Printing Width	57.5±0.5mm/48mm	
Printing density	384 dots	
Printing speed	5cm-10cm/s (@8.0V)	
Paper thickness	0.06~0.085mm	
Print life	500,000 line	
Build-in character library	ASCII (8 x 16 Dot Matrix) Times New Roman: ISO8859-1~16(Except for ISO8859-6 and ISO8859-12); ASCII (12 x 24 Dot Matrix) Times New Roman: ISO8859-1~16(Except for ISO8859-6, ISO8859-8, ISO8859-11,ISO8859-12); Unicode, Times New Roman: Latin(Basic/Supplement/Extended A/Extended B/Extended Additional; Greek; Cyrillic; Hebrew; Thai)	
<b>Interface</b>		
Wired	RS232 serial port	
Wireless	IEEE 802.15.1 - BT 4.0 single mode compliant	
	Integrated BLE stack	
	TX power: +3dBm to -23dBm	
	RX sensitivity: -85dBm to -91dBm	
<b>Electric specifications</b>		
Battery	Manufacturer: Shenzhen ONE Energy Technology Co., Ltd	
	Description: SNLB-165	
	Nominal voltage: 7.4V	
	Rated capacity: 700mAh	
Charger	Manufacturer: Shenzhen ABT Electronics Co., Ltd	
	Model: SNAD-A1220-3C2.1-01 (ABT020120)	
	Input voltage: 100~240V 50/60Hz (AC)	
	Input current: 0.8A	
	Output voltage: 12V	
	Output current: 2.0A	

<b>Environment specifications</b>	
Operating temperature/humidity	-10°C~50 °C/20%~80%(Relative humidity)
Charging temperature/humidity	-15°C~35 °C/20%~80%(Relative humidity)
Charging and Operating temperature/humidity	-15°C~35 °C/20%~80%(Relative humidity)
Storage temperature/humidity	-20°C~70 °C/5%~95%(Relative humidity)

## 9. Troubleshooting

Errors	Possible reasons	Solution
Operating Improperly		
Wireless printing failure, data transferred but both indication lights are off.	Power switch off, or after 150 seconds the printer has switched off automatically.	Please check the power Button.
Wireless printing failure, power is on, but function light is off.	The distance is over the maximum specified for wireless data transfer.	Please use a shorter distance between the devices
Wireless printing failure, the function light is flashing and continuous buzzer alarm is on.	Data transfer incomplete	Re-print the data
Wireless printing does not work	The pairing between host device and printer is not correct.	Make sure the host device uses the correct Printer ID. Compare Printer ID from self test printout to ID used in Host device
Paper does not feed in when the the function button is pressed	The button holding time is not long enough	Press and hold the function button until the Red LED is on and paper feed in.
Printing process interrupted and RED LED blinking	Out of paper	Install paper
Printing Error		
No response when the print button is pressed.	Low power	Recharge the battery
	Button damaged	Send back for service
Printing quality is below standard.	The printer head is damaged or the power is too low.	Send back for service
Paper is inserted into printer head but nothing is printed on paper after printing operation.	The printing paper is reverse.	Turn printing paper over and restart
	The printer head is damaged.	Send back for service.
The operating time of the device is too short even when the battery fully recharged.	The battery life has diminished.	Change the battery
Printout is incomplete	Strong electromagnetic interference	Move away from the source interference Print with the connection cable

## 10. Copyright and other notices



Hereby, **Shenzhen Envisen Industry Co., Limited** declares that this E-Print 202 product is in compliance with the European Electrical Compatibility Directive 2004/108/EC and European Directive LVD 2006/95/EC.

This device complies with Part 15 of the FCC Rules. Operation is subject to the following two conditions:

- (1) this device may not cause harmful interference,
- (2) this device must accept any interference received, including interference that may cause undesired operation.

Reproduction, transfer, distribution, or storage of part or all of the contents in this document in any form without the prior written permission of Envisen is prohibited. Envisen operates a policy of continuous development. Envisen reserves the right to make changes and improvements to any of the products described in this document without prior notice.