

Compressed air grease gun

Operating instructions



Contents:

- 1. General Data**
 - 1.1 Recommended Usage
 - 1.2 Structure and Application Description
 - 1.3 Technical Data
 - 1.4 Recommended Operation Areas
- 2. General Safety Instructions**
 - 2.1 Safety Requirements
 - 2.2 Explanation of the General Safety Instructions
 - 2.3 Dangers when utilizing the compressed air grease gun
- 3. Assembly**
- 4. Initial or Repeated Operation**
 - 4.1 Filling of the compressed air grease gun
 - 4.2 Readiness for Service
- 5. Betrieb**
- 6. Maintenance/Service**
- 7. Replacement parts/accessories**
- 8. Fault Finding**
- 9. Repair/service**
- 10. Manufacturer's declaration**

1. General Data

1.1 Recommended Usage

- The compressed air grease gun is exclusively designed for the use of lubricating grease.
- We ask you to follow up strictly the recommendations for usage shown in these operating instructions.
- Every further usage (other media or using force) or unauthorised modification (reconstruction, no original accessories) may cause dangers and will not be covered by our warranty regulation.
- The operator is liable for damages caused by non-authorized operations.

1.2 Structure and Application Description

- The pneumatic grease gun is a grease gun working with compressed air.
- The pneumatic grease pump is equipped with a spring loaded gasket seal sleeve to assist the grease haulage.
- The pneumatic grease pump can be supplied with different accessories (from Pressol accessories).

1.3 Technical Data

	Pneumatic Grease Gun DL DL plus	Automatic Pneumatic Grease Gun DL automatic
Diameter of piston:	6 mm	6 mm
Delivery volume per stroke:	0,8 cm ³	0,8 cm ³
Actuation grease piston:	Single stroke grease supply – Grease flow by compressed air engine	Continual grease supply by compressed air engine
Maximum air pressure (compressed air operation):	8 bar	8 bar
Pressure ratio:	50 : 1	50 : 1
Operating pressure	400 bar	400 bar
Grease gun connection, pressure side:	M 10 x 1	M 10 x 1
Compressed air adapter:	Quick connection adapter Rectus Typ 26	Quick connection adapter Rectus Typ 26
Burst pressure (system):	850 bar	850 bar
Burst pressure (grease gun head):	1200 bar	1200 bar
Capacity:	500 cm ³	500 cm ³
Loading:	400 gr grease cartridge (DIN 1284) Grease gun filling system	400 gr grease cartridge (DIN 1284) Grease gun filling system

1.4 Recommended Operation Areas

- The pneumatic grease gun is recommended for supplying grease up to NLGI 2 viscosity greases.
- The pneumatic grease gun can both be used with standard grease cartridges in accordance with DIN 1284 or with a grease gun filling system.

2. General Safety Instructions

2.1 Safety Requirements

- The compressed air grease gun is designed and manufactured with regards to the general safety and health requirements and according to the relevant European Community regulations.
- However, risks cannot be avoided if this product will not be used according to the recommended usage or when utilizing it without the necessary diligence and care.
- To prevent accidents we recommend to use our product strictly according to the local safety regulations and as well according to our safety instructions shown in these operating instructions.

2.2 Explanation of the General Safety Instructions

When studying these General Safety Instructions please consider the different levels of danger. These levels of danger are marked by the following signal terms or pictograms:

Pictogram	Signal term	Consequences when ignoring the General Safety Instructions.
	Attention!	Potential minor or medium personal harm or material-damages.

Table. 2 1: Classification of the safety instructions according to the kind of the dangers

Furthermore, an other advise for the operation of this product is also used.

Pictogram	Signal term	Meaning
	Note	Basic knowledge and advises for the correct operation of this product.

Table 2 2: General Advise

2.3 Dangers when utilizing the compressed air grease gun



<p>Attention!</p> <p>Overpressure may cause damages of grease gun head and its accessories!</p> <ul style="list-style-type: none"> ➤ Do not exceed the working pressure stated in chapter 1.3. ➤ We recommend the use of original accessories according to DIN 1283 only.



<p>Attention!</p> <p>Overpressure at the point of lubrication may destroy the grease nipple and perhaps even the bearings or the machine itself!</p> <ul style="list-style-type: none"> ➤ Do not exceed the working pressure stated in chapter 1.3. ➤ Please pay attention to the maintenance and service advices of the manufacturer of your machine.
--



Attention!

Defective accessories can do damages to property and persons!

- High-pressure hoses may not be bent, twisted or stretched.
- Accessories will have to be checked for abrasion, cracks or further damages permanently.
- Defective accessories will have to be exchanged immediately.
- The utilisation period of the hose lines is 6 years max. after date of production (see description on the hose).

3. Assembly

- The compressed air grease gun will be delivered completely assembled.
- Accessories will have to be mounted depending on the version used.



Note

When assembling the system, cleanliness and an exact connection of the accessories to the grease gun head is required.

Please use suitable sealing material (e.g. Teflon film), only.

4. Initial or Repeated Operation

Check the completeness of the grease gun and the fixed accessories.

4.1 Filling of the compressed air grease gun

There are different filling options for the compressed air grease gun.

- Filling with a grease gun filling pump
- Filling with a grease cartridge acc. to DIN 1284

4.1.1 Filling with a grease gun filling pump



Attention!

Do not disassemble the grease gun unless having released the pressure before!

- Every time that the grease gun head and cylinder are to be separated, the push rod must be fully retracted and automatically locked by means of the safety catch.

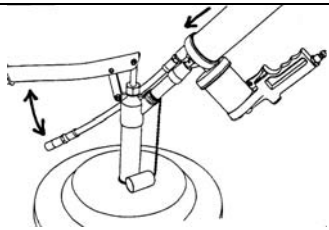

Grease gun with the nipple is to be put on the filling valve of the filling system and kept with slight counter pressure.

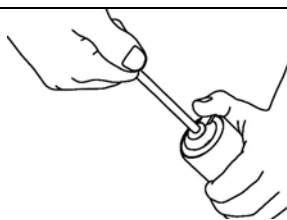

Filling of the grease gun by operating the filling system (lever action pump).



Pull on the push rod, actuate the safety catch, and push the push rod back into the cylinder.

4.1.2 Refilling of grease cartridge according to DIN 1284

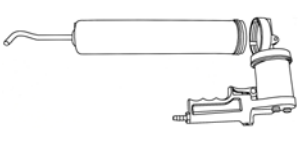

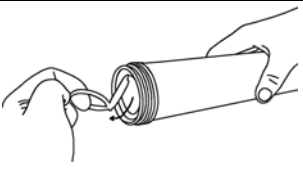
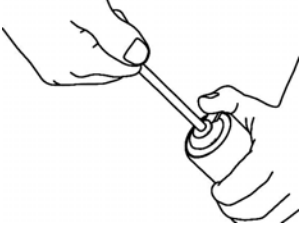
<p>Attention!</p> <p>Do not disassemble the grease gun unless having released the pressure before!</p> <p>➤ Every time that the grease gun head and cylinder are to be separated, the push rod must be fully retracted and automatically locked by means of the safety catch.</p>	
	<p>Pull back the push rod and unscrew the grease gun head.</p>
	<p>Remove the sealing cap from the full cartridge, and guide this into the grease gun cylinder.</p>
	<p>Only then tear off the cartridge's "pull-off" closure and screw on the grease gun head.</p>
	<p>Pull on the push rod, actuate the safety catch, and push the push rod back into the cylinder.</p>

4.2 Readiness for Service

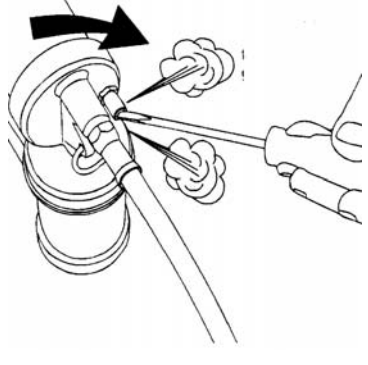
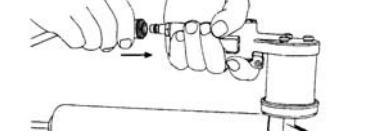

<p>Note</p> <p>Check that the grease gun head and cylinder are tightly screwed together.</p>	
	<p>Remove air from the grease-containing section via the combined filling / air removal nipple on the grease gun head by loosening the gun head and cylinder (half a turn maximum) or by repeatedly actuating the hand lever.</p>
	<p>Connect the compressed air supply (max. 8 bar) to the connection nipple located on the handle.</p>

- The grease gun is now ready for use.

5. Betrieb

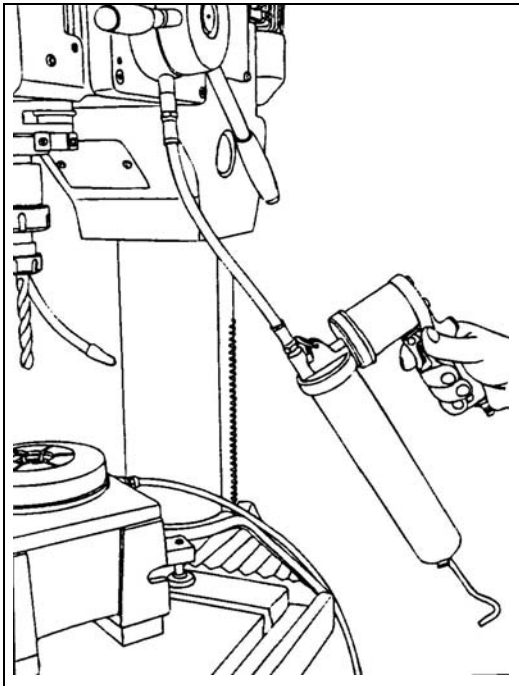

- Connect the hydraulic coupler of the grease gun to the grease nipple.
- By pulling the trigger of the grease gun the greasing work starts.

Caution:

Single-stroke grease supply is normally the standard with pneumatic grease pumps.

One pull of the trigger delivers one single stroke grease supply.

The automatic pneumatic grease pump delivers a continuous grease flow.

While keeping pulling the trigger the automatic grease pump delivers a continuous grease flow.



Attention!

Overpressure may cause damages of grease gun head and its accessories.

- Do not exceed the working pressure stated in chapter 1.3.
- We recommend the use of original accessories according to DIN 1283 only.



Attention!

Overpressure at the point of lubrication may destroy the grease nipple and perhaps even the bearings or the machine itself.

- Do not exceed the working pressure stated in chapter 1.3.
- Please pay attention to the maintenance and service advices of the manufacturer of your machine.



Advise

Disconnect the quick coupler of the grease gun from the compressed air supply if the greasing procedure has been achieved or if the pneumatic grease gun is not to be used for a while to avoid an unintentional discharge of the grease cartridge or to prevent leakage.

6. Maintenance/Service

In general, the compressed air grease gun does not require much service and maintenance at all.

Due to the operator's duties the following parts will have to be checked regularly for function, to avoid environmental and material-damages as well as personal harm:

- Grease gun head
- Screwed connections
- Accessories (high pressure hoses, couplers, etc.)

7. Replacement parts/accessories

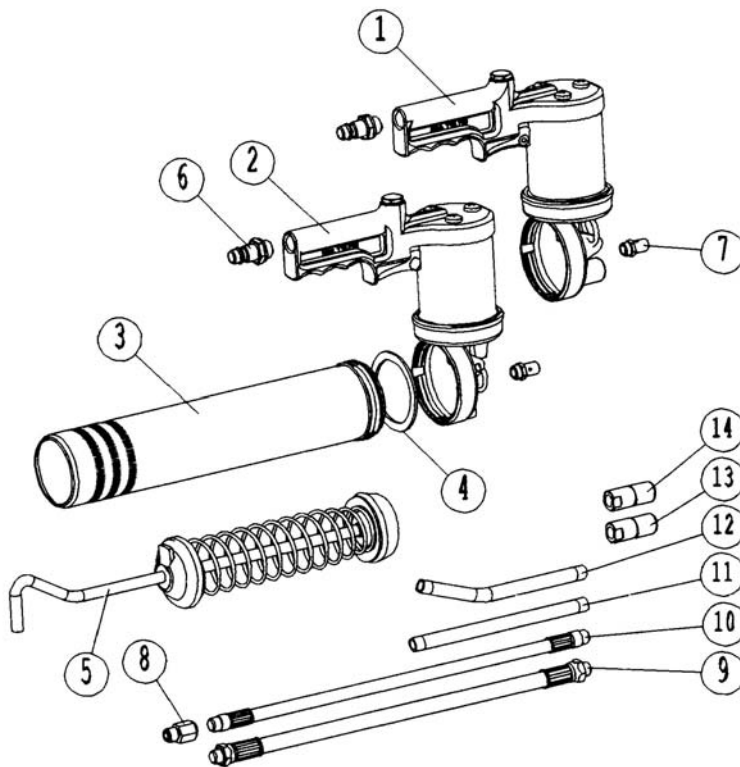

Replacement parts list

No.	Description	Pneumatic grease gun			Automatic pneumatic grease gun	
		18071	18072	18074	18073	18077
1	Compressed air engine		03 171			
2	Compressed air engine	03 169		03 170	03 169	03 170
3	Tube, 500 ccm	00 361	00 361	00 361	00 361	00 361
4	Seal	00 442	00 442	00 442	00 442	00 442
5	Push rod	00 443	00 443	00 443	00 443	00 443
6	Male quick release adapter	01 275	20 062	20 062	01 275	20 062
7	Filling nipple	12 670	12 670	12 670	12 670	12 670

Accessories as per DIN 1283

(extract from the PRESSOL range of accessories)

No.	Description		M 10 x 1	G 1/8"
8	Adapter, G 1/8" i; M 10 x 1 a	12 016		
9	High pressure, 11 x 300 mm		12 655	12 755
10	High pressure, 8 x 300 mm		12 656	12 756
11	Spout, straight		12 435	12 475
12	Spout, angled		12 635	12 735
13	Hydraulic coupler		12 631	12 731
14	Precision machined coupler		12 643	12 743

8. Fault Finding

Fault	Cause	Solution
Engine is not working or is working very slowly.	Too low air pressure level.	Set up air pressure to 3 bar minimum.
Engine is working but there is no grease supply or to a very small rate.	Air pockets in the grease or inside the pump head.	Remove air from grease gun (see 4.2).
	No grease inside the gun.	Fill in the grease gun (see 4.1.1 and 4.1.2).
Engine is under counterpressure.	Too low air pressure level.	Set up air pressure to 8 bar maximum.
	Too strong counterpressure	Check the grease nipple / greased part. Change the grease nipple if necessary.

9. Repair/service

The compressed air grease gun was developed and manufactured under compliance with the highest quality standards.

If in spite of all quality measures a problem occurs, please get in touch with our service contact partners:

Customer Service and Repair department

PRESSOL Schmiergeräte GmbH

Tel. +49 911 32 441-35 • Fax +49 911 32 441-65 • export@pressol.com

10. Manufacturer's declaration

We hereby state that the equipment described below, in the model which we have made commercially available, complies in its design and construction with the applicable requirements. If the equipment is used other than for its intended purpose, this declaration loses its validity.

Equipment	Grease gun
Type	Pneumatic grease gun Automatic pneumatic grease gun
Applicable EC-Directives	EU-Directive Machines annex 1 89/392 EEC-Directive dated September, 14th. 1989 91/368 EEC-Directive dated June, 6th. 1991 93/68 EEC-Directive dated August, 30th. 1993
Applicable National Standards	DIN EN 292, part 1, part 2 DIN EN 45014 DIN 1283

25.02.2008

PRESSOL Schmiergeräte GmbH

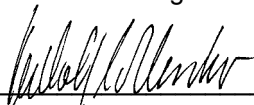

Dipl.-Ing. Rudolf Schlenker

PRESSOL Schmiergeräte GmbH • Parkstraße 7 • D-93167 Falkenstein

Tel. +49 9462 17-0 • Fax +49 9462 17-208 • info@pressol.com • www.pressol.com